

OBSOLETE PRODUCT

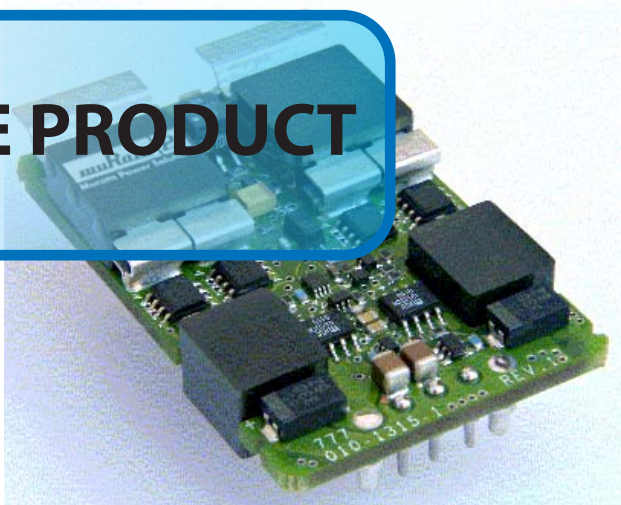

Model		3.3V	Units
Parameter			
Output Voltage Setpoint		3.25 – 3.35	Vdc
Line/Load Regulation	Max	0.1, 0.2	% Vo
Output total regulation		3.20 – 3.40	Vdc
Output adjust		95-110	%Vo,nom
Remote-sense Comp.		10	%Vo,nom
Output Ripple & Noise (note 2)	Max	100	mVp-p
Output Current	Min	0.1	A
	Max	35	A
Efficiency (48V, Full load, 25C)	Typ	90.5	%
External Capacitance	Max	10,000	μF
Transient Response (typ) (note3)	ΔVo	165	mV
25% step, 1A/μs	Ts	300	μs
Over-voltage trip point (latching)	-static -dynamic	max	4.2 – 4.6
			V
Over-current trip point (non-latching)	Typ	44	A

All specifications at Ta=25C, Vin=48V, 300 LFM unless otherwise specified



For full details go to
www.murata-ps.com/rohs

Parameter	Conditions	Min.	Typ.	Max.	Units
Input	Input Voltage (Vin)	36	48	75	Vdc
	Reflected Ripple Current (see note 1)	--	--	10	mA p-p
	Input Current			4	A
	Inrush Transient			0.2	A ² s
Undervoltage Lockout	Turn-on	32		35	Vdc
		31		34	Vdc
	Turn-off	76		80	Vdc
		75		79	Vdc
Isolation	Input-Output	1500			Vdc
	Resistance; input-output	10			Mohm
Temperature	Operating Ambient	-40	--	85	°C
	Storage	-40	--	125	°C
Protection	Over-Temperature Measured on PCB	--	120	--	°C
Physical Information	Dimensions	2.28"L x 1.45" W x 0.47"H (57.91 x 36.83 x 11.8 mm)			
MTBF(Bellcore)	Calculated at 40C ambient, 100% Iomax:	1,000,000 Hrs			
Safety	The QHS35-033 complies with IEC/EN/CSA 60950 safety requirements, providing basic insulation, input to output. c-UL-us (US & Canada) recognized. TUV (Bauart) approved.				

QHS35-033 Thermal Derating
T_J = 120°C Airflow Parallel To +Vin to -Vin

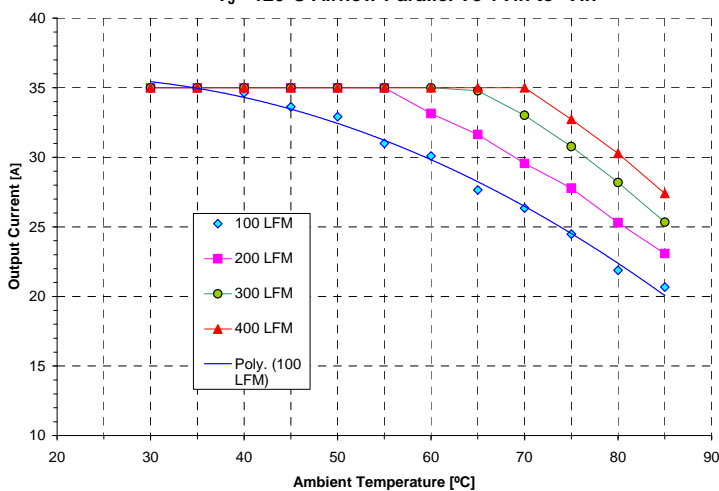

QHS35-033 Thermal Derating

T_J = 120°C Ver. Orientation for 0LFM, Hor. Orientation for 50LFM, Vin to Vout Airflow

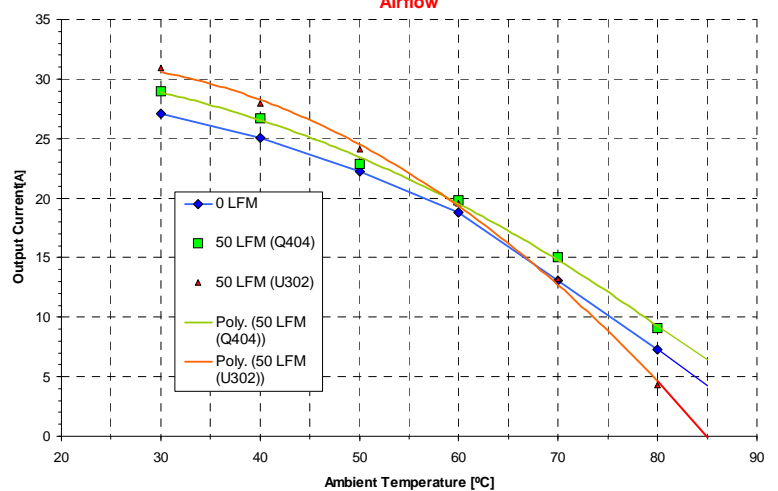

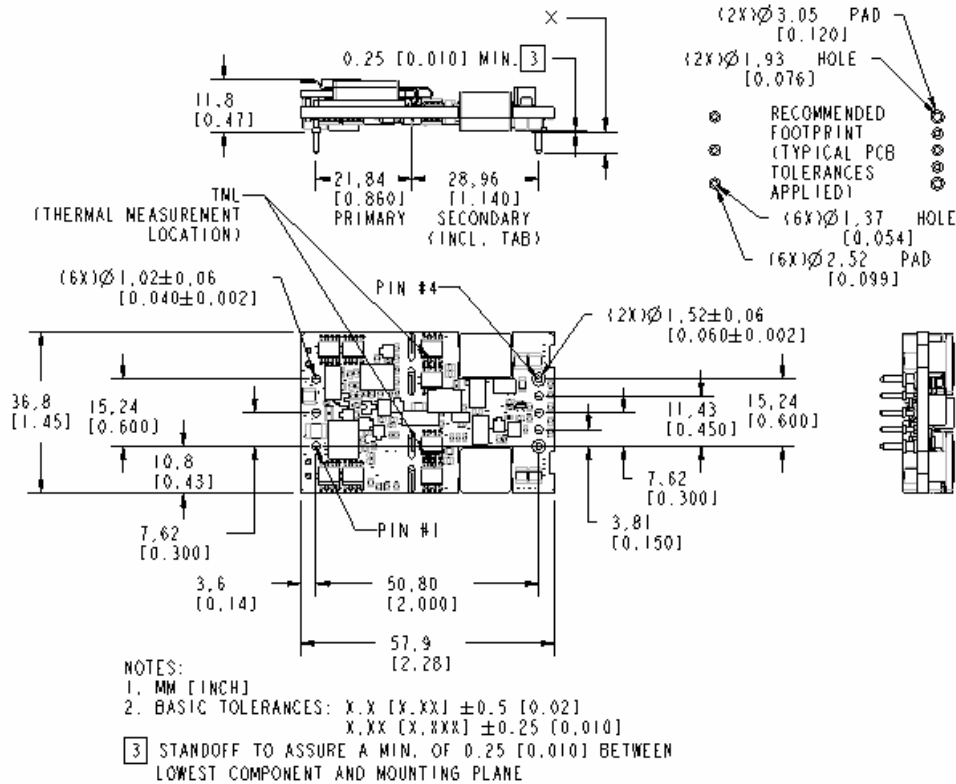

Pin Assignments

Pin #	Description	Pin #	Description	Pin #	Description
1	Vin (+)	4	Vout(-)	7	Sense +
2	Enable (note 4)	5	Sense -	8	Vo (+)
3	Vin(-)	6	Vo adj		

Notes:

1. Input Reflected Ripple is specified when measured with the filter shown below.

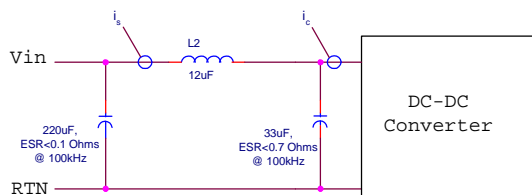

2. Output Ripple and noise is specified when measured with a 10uF tantalum and a 1uF ceramic capacitor at the converter output pins.
3. Transient response is specified without a capacitor at the output of the converter.
4. Enable pin: 2.5V < enable high < 15V, 0V < enable low < 0.8V. Internal pull-up is 5V @ > 50Kohm.
5. For thermal measurement location (TML) refer to mechanical drawing.

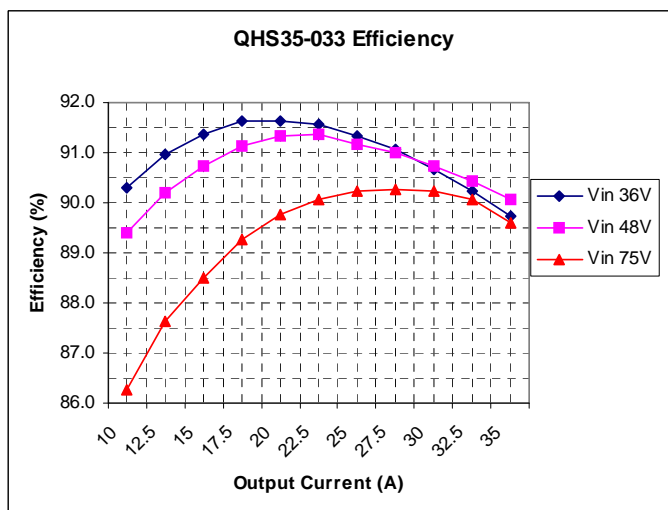

Output Ripple and Noise
(Vin=48V, Io=35A, 100Mz BW)
Note 2

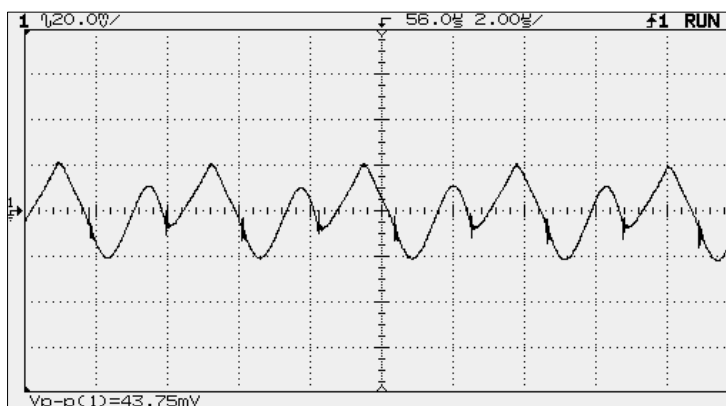

Output Voltage Response to Step Load (25.5A, -17.5A load step, di/dt = 1A/us, Tamb=25C, Vin=48V)

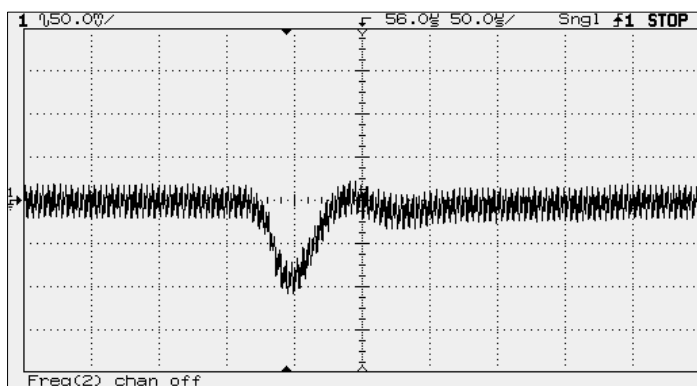

Output Voltage Response to Step Load (25.5A, +17.5A load step, di/dt = 1A/us, Tamb=25C, Vin=48V)

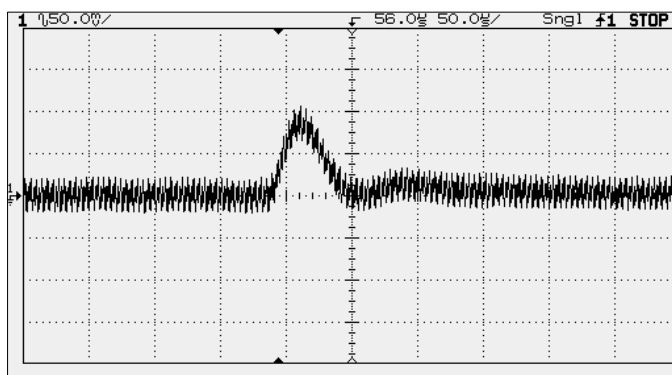

Input Reflected Ripple (Vin=48V, Iout=35A)

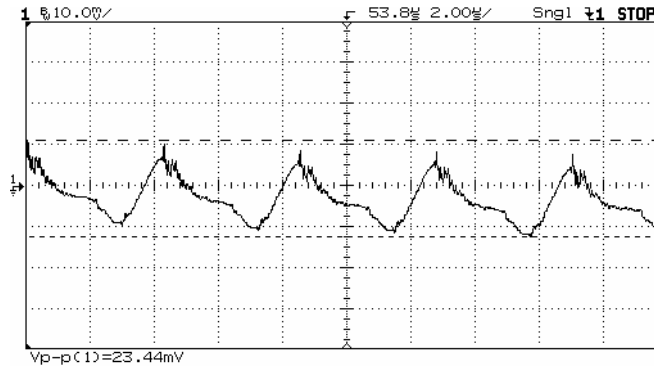

Turn-on, Startup Inhibit Delay

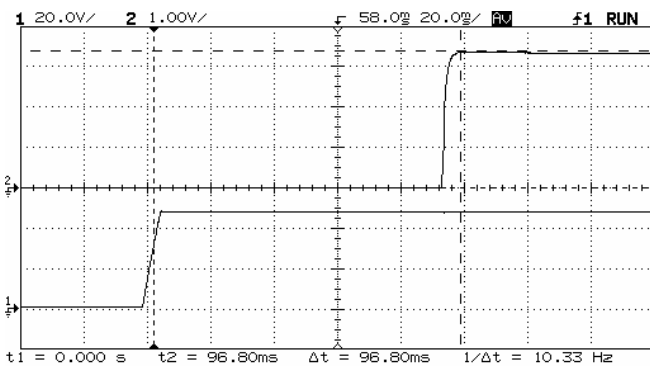

Vin=48V, Iout =35A, Cout=10,000uF, Enable tied to Vi(-)
 CH1: Vin 20V/div
 CH2: Vout @ 1V/div time base 20ms/div

Turn-on from Enable

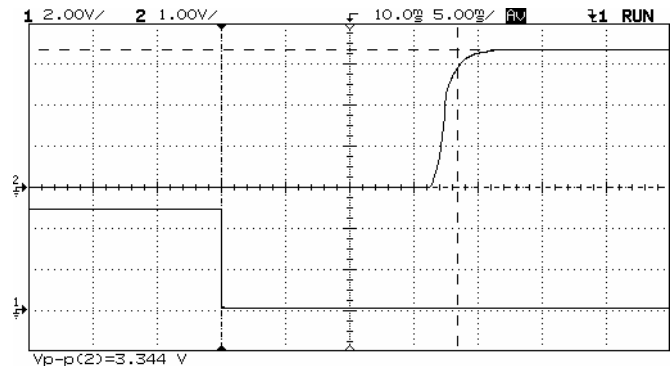

Vin=48V, Iout =35A, Cout=10,000uF
 CH1: Vout 1V/div time base 5ms/div
 CH2 Enable pin 2V/div

Turn-Off Characteristic

Vin = 48V Iout = 35A 10mF output capacitance

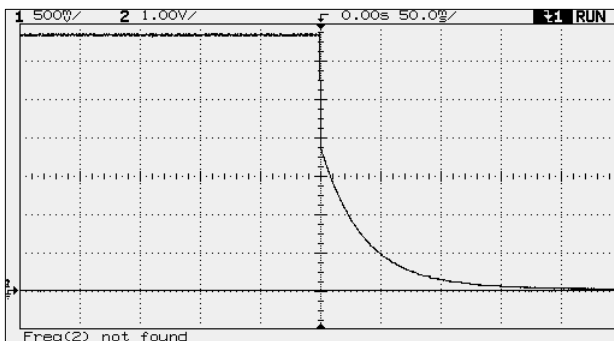

Pre-Bias Startup Characteristic

Vin = 48V Pre-bias of 2.2V

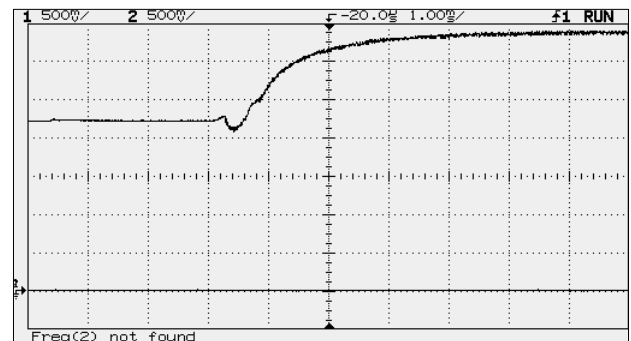

Conducted EMI Characteristic with external filter as specified

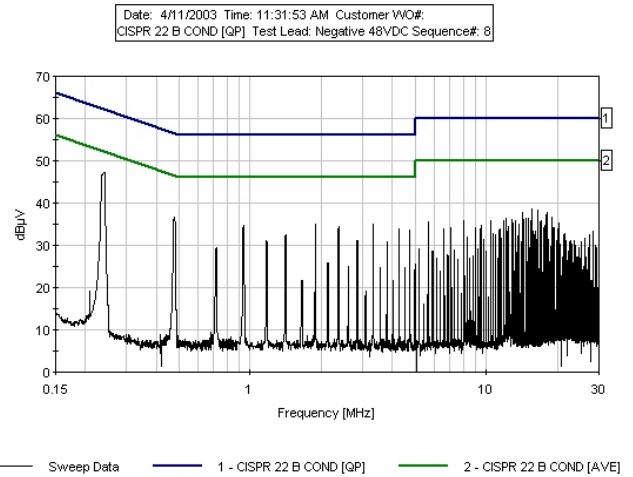
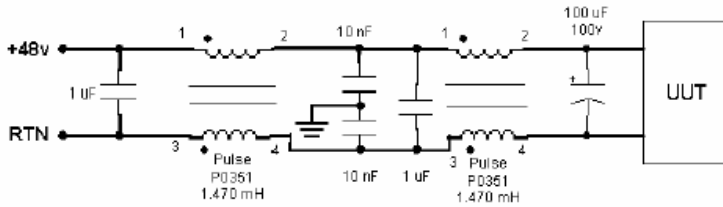

$$R_{up}(V_{nom}, \Delta\%) := \left[5.11 \cdot V_{nom} \cdot \frac{(100 + \Delta\%)}{1.225 \cdot \Delta\%} \right] - \left(\frac{511}{\Delta\%} \right) - 10.22$$

$$R_{dwn}(\Delta\%) := \frac{511}{\Delta\%} - 10.22$$

$$\Delta\% = \lceil 100 \times (V_o - V_{nom}) / V_{nom} \rceil$$

V_o : target output voltage

V_{nom} : nominal output voltage

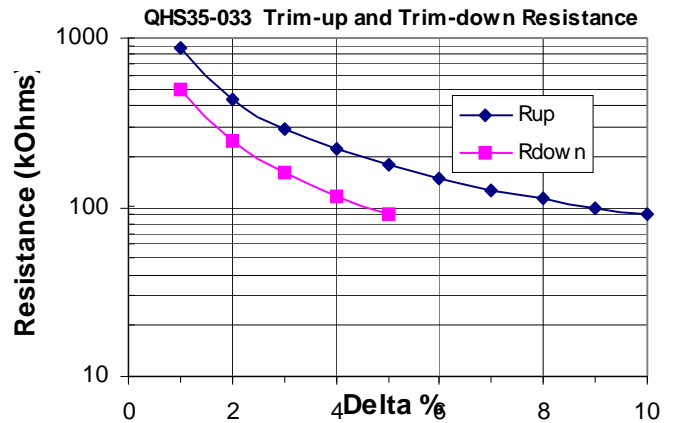

Safety considerations

The QHS35-033 complies with IEC/EN/CSA 60950 safety requirements, providing basic insulation, input to output. c-UL-us (US & Canada) recognized. An external input fuse, rated at 5A to 20/30A, fast-blow type, must be used to meet the above requirements. The fuse will isolate the failed converter from the input source and protect the distribution wiring from overheating. The output of the converter is considered to remain within SELV limits when the input to the converter meets SELV requirements

The converters are designed to meet UL 94V-0 flammability ratings.

Part Number Designations

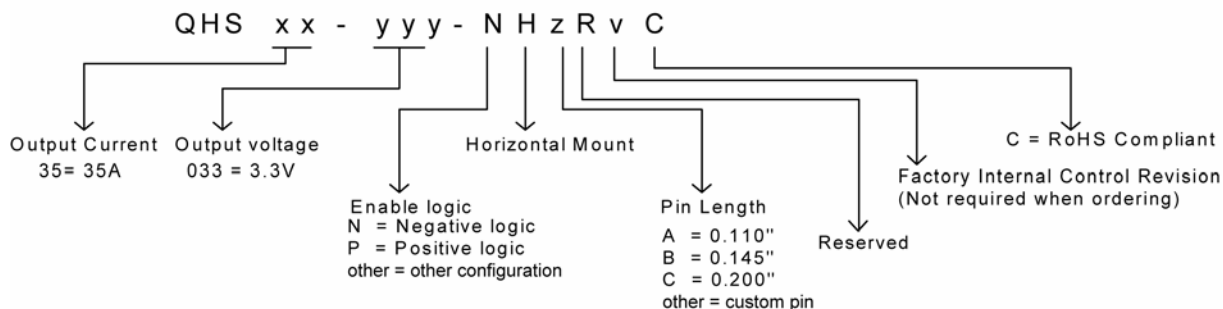

Murata Power Solutions, Inc.
 11 Cabot Boulevard, Mansfield, MA 02048-1151 U.S.A.
 ISO 9001 and 14001 REGISTERED



This product is subject to the following [operating requirements](http://www.murata-ps.com/requirements/) and the [Life and Safety Critical Application Sales Policy](http://www.murata-ps.com/requirements/): Refer to: <http://www.murata-ps.com/requirements/>

Murata Power Solutions, Inc. makes no representation that the use of its products in the circuits described herein, or the use of other technical information contained herein, will not infringe upon existing or future patent rights. The descriptions contained herein do not imply the granting of licenses to make, use, or sell equipment constructed in accordance therewith. Specifications are subject to change without notice. © 2012 Murata Power Solutions, Inc.



Компания «ЭлектроПласт» предлагает заключение долгосрочных отношений при поставках импортных электронных компонентов на взаимовыгодных условиях!

Наши преимущества:

- Оперативные поставки широкого спектра электронных компонентов отечественного и импортного производства напрямую от производителей и с крупнейших мировых складов;
- Поставка более 17-ти миллионов наименований электронных компонентов;
- Поставка сложных, дефицитных, либо снятых с производства позиций;
- Оперативные сроки поставки под заказ (от 5 рабочих дней);
- Экспресс доставка в любую точку России;
- Техническая поддержка проекта, помощь в подборе аналогов, поставка прототипов;
- Система менеджмента качества сертифицирована по Международному стандарту ISO 9001;
- Лицензия ФСБ на осуществление работ с использованием сведений, составляющих государственную тайну;
- Поставка специализированных компонентов (Xilinx, Altera, Analog Devices, Intersil, Interpoint, Microsemi, Aeroflex, Peregrine, Syfer, Eurofarad, Texas Instrument, Miteq, Cobham, E2V, MA-COM, Hittite, Mini-Circuits, General Dynamics и др.);

Помимо этого, одним из направлений компании «ЭлектроПласт» является направление «Источники питания». Мы предлагаем Вам помощь Конструкторского отдела:

- Подбор оптимального решения, техническое обоснование при выборе компонента;
- Подбор аналогов;
- Консультации по применению компонента;
- Поставка образцов и прототипов;
- Техническая поддержка проекта;
- Защита от снятия компонента с производства.



Как с нами связаться

Телефон: 8 (812) 309 58 32 (многоканальный)

Факс: 8 (812) 320-02-42

Электронная почта: org@eplast1.ru

Адрес: 198099, г. Санкт-Петербург, ул. Калинина, дом 2, корпус 4, литера А.