

# BCW72LT1G, SBCW72LT1G

## General Purpose Transistor NPN Silicon

### Features

- AEC-Q101 Qualified and PPAP Capable
- S Prefix for Automotive and Other Applications Requiring Unique Site and Control Change Requirements
- These Devices are Pb-Free, Halogen Free/BFR Free and are RoHS Compliant\*

### MAXIMUM RATINGS

Rating	Symbol	Value	Unit
Collector - Emitter Voltage	$V_{CEO}$	45	Vdc
Collector - Base Voltage	$V_{CBO}$	50	Vdc
Emitter - Base Voltage	$V_{EBO}$	5.0	Vdc
Collector Current - Continuous	$I_C$	100	mAdc

### THERMAL CHARACTERISTICS

Characteristic	Symbol	Max	Unit
Total Device Dissipation FR-5 Board, (Note 1) $T_A = 25^\circ\text{C}$ Derate above $25^\circ\text{C}$	$P_D$	225 1.8	mW mW/ $^\circ\text{C}$
Thermal Resistance, Junction-to-Ambient	$R_{\theta JA}$	556	$^\circ\text{C}/\text{W}$
Total Device Dissipation Alumina Substrate, (Note 2) $T_A = 25^\circ\text{C}$ Derate above $25^\circ\text{C}$	$P_D$	300 2.4	mW mW/ $^\circ\text{C}$
Thermal Resistance, Junction-to-Ambient	$R_{\theta JA}$	417	$^\circ\text{C}/\text{W}$
Junction and Storage Temperature	$T_J, T_{stg}$	-55 to +150	$^\circ\text{C}$

Stresses exceeding Maximum Ratings may damage the device. Maximum Ratings are stress ratings only. Functional operation above the Recommended Operating Conditions is not implied. Extended exposure to stresses above the Recommended Operating Conditions may affect device reliability.

1. FR-5 = 1.0 x 0.75 x 0.062 in.
2. Alumina = 0.4 x 0.3 x 0.024 in. 99.5% alumina.

\*For additional information on our Pb-Free strategy and soldering details, please download the ON Semiconductor Soldering and Mounting Techniques Reference Manual, SOLDERRM/D.



ON Semiconductor®

<http://onsemi.com>

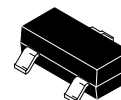

SOT-23  
(TO-236)  
CASE 318-08  
STYLE 6

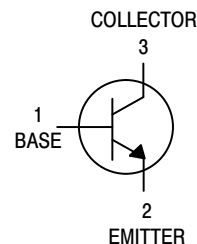

### MARKING DIAGRAM

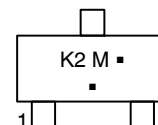

K2 = Device Code  
M = Date Code\*  
▪ = Pb-Free Package

(Note: Microdot may be in either location)

\*Date Code orientation and/or overbar may vary depending upon manufacturing location.

### ORDERING INFORMATION

Device	Package	Shipping†
BCW72LT1G	SOT-23 (Pb-Free)	3,000 / Tape & Reel
SBCW72LT1G	SOT-23 (Pb-Free)	3,000 / Tape & Reel

†For information on tape and reel specifications, including part orientation and tape sizes, please refer to our Tape and Reel Packaging Specifications Brochure, BRD8011/D.

# BCW72LT1G, SBCW72LT1G

## ELECTRICAL CHARACTERISTICS (T<sub>A</sub> = 25°C unless otherwise noted)

Characteristic	Symbol	Min	Typ	Max	Unit
<b>OFF CHARACTERISTICS</b>					
Collector – Emitter Breakdown Voltage (I <sub>C</sub> = 2.0 mA <sub>dc</sub> , V <sub>EB</sub> = 0)	V <sub>(BR)CEO</sub>	45	–	–	V <sub>dc</sub>
Collector – Emitter Breakdown Voltage (I <sub>C</sub> = 2.0 mA <sub>dc</sub> , V <sub>EB</sub> = 0)	V <sub>(BR)CES</sub>	45	–	–	V <sub>dc</sub>
Collector – Base Breakdown Voltage (I <sub>C</sub> = 10 μA <sub>dc</sub> , I <sub>E</sub> = 0)	V <sub>(BR)CBO</sub>	50	–	–	V <sub>dc</sub>
Emitter – Base Breakdown Voltage (I <sub>E</sub> = 10 μA <sub>dc</sub> , I <sub>C</sub> = 0)	V <sub>(BR)EBO</sub>	5.0	–	–	V <sub>dc</sub>
Collector Cutoff Current (V <sub>CB</sub> = 20 V <sub>dc</sub> , I <sub>E</sub> = 0) (V <sub>CB</sub> = 20 V <sub>dc</sub> , I <sub>E</sub> = 0, T <sub>A</sub> = 100°C)	I <sub>CBO</sub>	–	–	100 10	nA <sub>dc</sub> μA <sub>dc</sub>
<b>ON CHARACTERISTICS</b>					
DC Current Gain (I <sub>C</sub> = 2.0 mA <sub>dc</sub> , V <sub>CE</sub> = 5.0 V <sub>dc</sub> )	h <sub>FE</sub>	200	–	450	–
Collector – Emitter Saturation Voltage (I <sub>C</sub> = 10 mA <sub>dc</sub> , I <sub>B</sub> = 0.5 mA <sub>dc</sub> ) (I <sub>C</sub> = 50 mA <sub>dc</sub> , I <sub>B</sub> = 2.5 mA <sub>dc</sub> )	V <sub>CE(sat)</sub>	– –	– 0.21	0.25 –	V <sub>dc</sub>
Base – Emitter Saturation Voltage (I <sub>C</sub> = 50 mA <sub>dc</sub> , I <sub>B</sub> = 2.5 mA <sub>dc</sub> )	V <sub>BE(sat)</sub>	–	0.85	–	V <sub>dc</sub>
Base – Emitter On Voltage (I <sub>C</sub> = 2.0 mA <sub>dc</sub> , V <sub>CE</sub> = 5.0 V <sub>dc</sub> )	V <sub>BE(on)</sub>	0.6	–	0.75	V <sub>dc</sub>
<b>SMALL – SIGNAL CHARACTERISTICS</b>					
Current – Gain – Bandwidth Product (I <sub>C</sub> = 10 mA <sub>dc</sub> , V <sub>CE</sub> = 5.0 V <sub>dc</sub> , f = 100 MHz)	f <sub>T</sub>	–	300	–	MHz
Output Capacitance (I <sub>E</sub> = 0, V <sub>CB</sub> = 10 V <sub>dc</sub> , f = 1.0 MHz)	C <sub>obo</sub>	–	–	4.0	pF
Input Capacitance (I <sub>E</sub> = 0, V <sub>CB</sub> = 10 V <sub>dc</sub> , f = 1.0 MHz)	C <sub>ibo</sub>	–	9.0	–	pF
Noise Figure (I <sub>C</sub> = 0.2 mA <sub>dc</sub> , V <sub>CE</sub> = 5.0 V <sub>dc</sub> , R <sub>S</sub> = 2.0 kΩ, f = 1.0 kHz, BW = 200 Hz)	NF	–	–	10	dB

## EQUIVALENT SWITCHING TIME TEST CIRCUITS

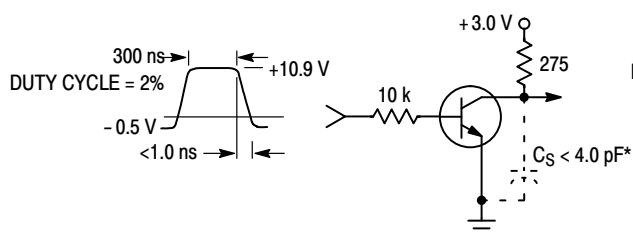

Figure 1. Turn-On Time

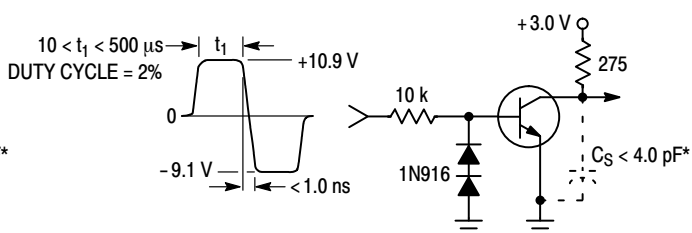

Figure 2. Turn-Off Time

\*Total shunt capacitance of test jig and connectors

# BCW72LT1G, SBCW72LT1G

## TYPICAL NOISE CHARACTERISTICS

( $V_{CE} = 5.0 \text{ Vdc}$ ,  $T_A = 25^\circ\text{C}$ )

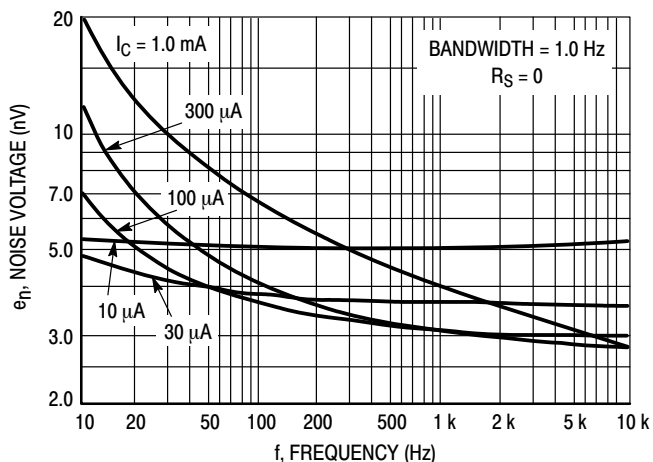

Figure 3. Noise Voltage

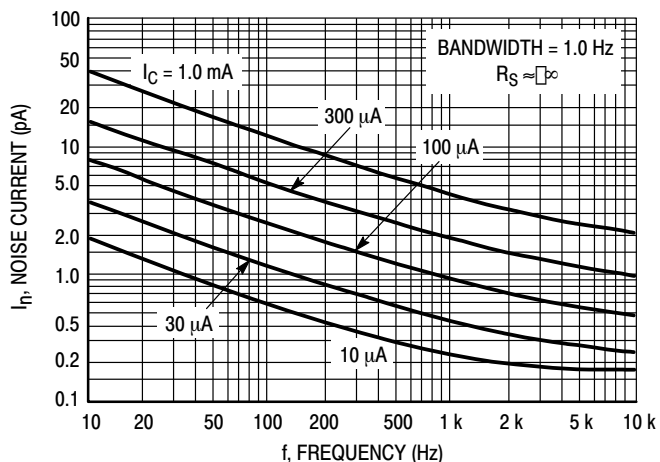

Figure 4. Noise Current

## NOISE FIGURE CONTOURS

( $V_{CE} = 5.0 \text{ Vdc}$ ,  $T_A = 25^\circ\text{C}$ )

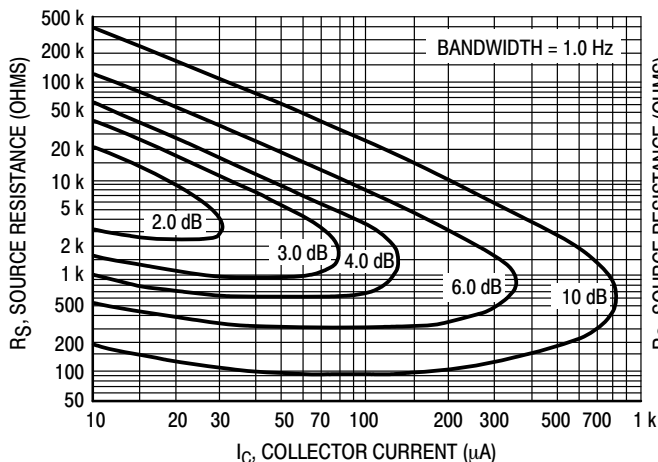

Figure 5. Narrow Band, 100 Hz

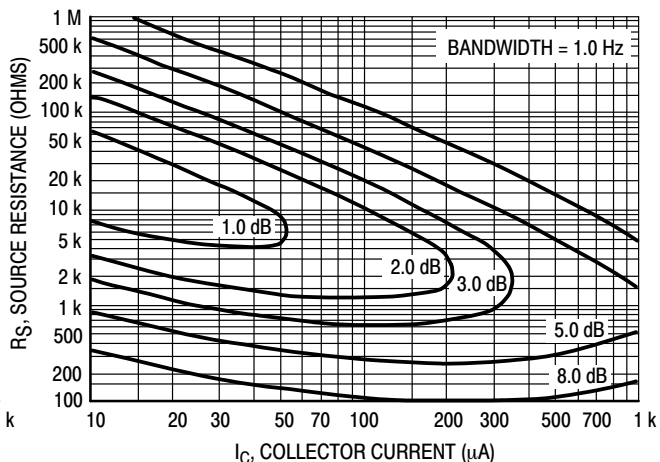

Figure 6. Narrow Band, 1.0 kHz

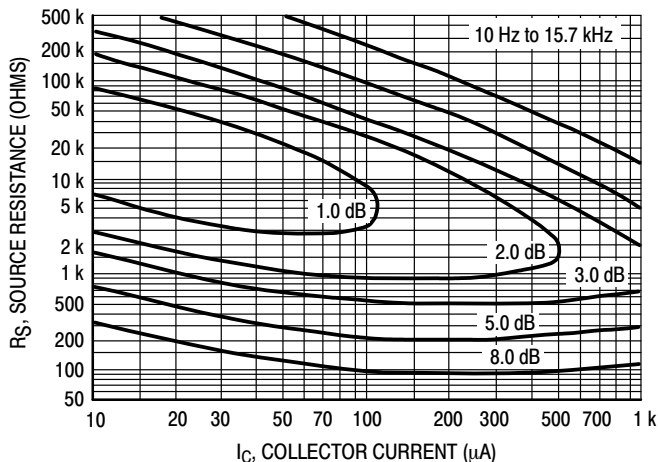

Figure 7. Wideband

Noise Figure is defined as:

$$NF = 20 \log_{10} \left( \frac{e_n^2 + 4KTR_S + I_n^2 R_S^2}{4KTR_S} \right)^{1/2}$$

$e_n$  = Noise Voltage of the Transistor referred to the input. (Figure 3)

$I_n$  = Noise Current of the Transistor referred to the input. (Figure 4)

$K$  = Boltzman's Constant ( $1.38 \times 10^{-23} \text{ J}^\circ\text{K}$ )

$T$  = Temperature of the Source Resistance ( $^\circ\text{K}$ )

$R_S$  = Source Resistance (Ohms)

# BCW72LT1G, SBCW72LT1G

## TYPICAL STATIC CHARACTERISTICS

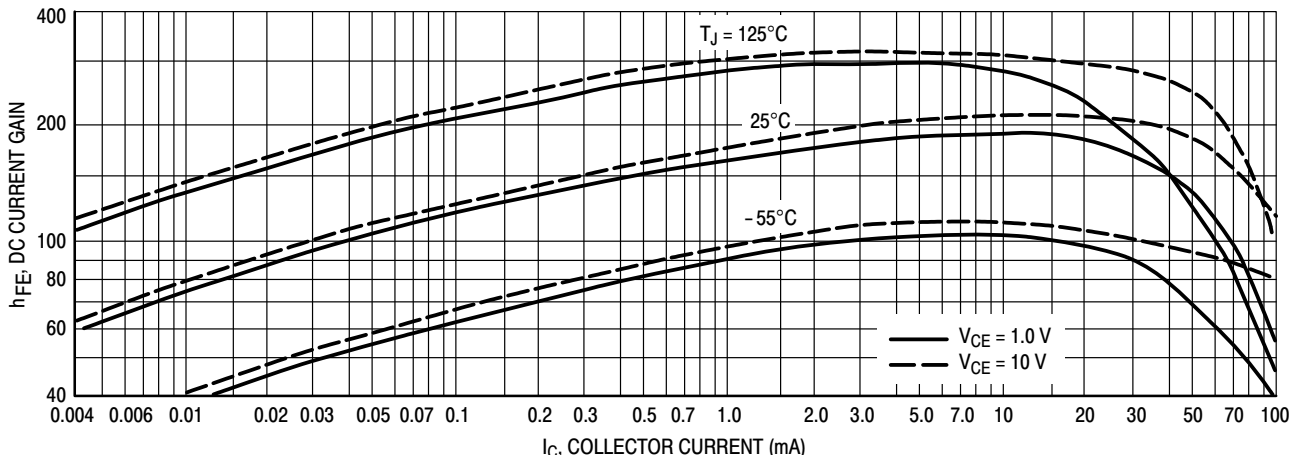

Figure 8. DC Current Gain

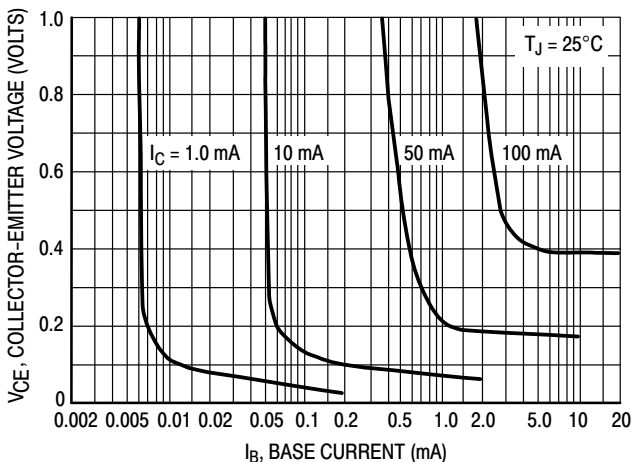

Figure 9. Collector Saturation Region

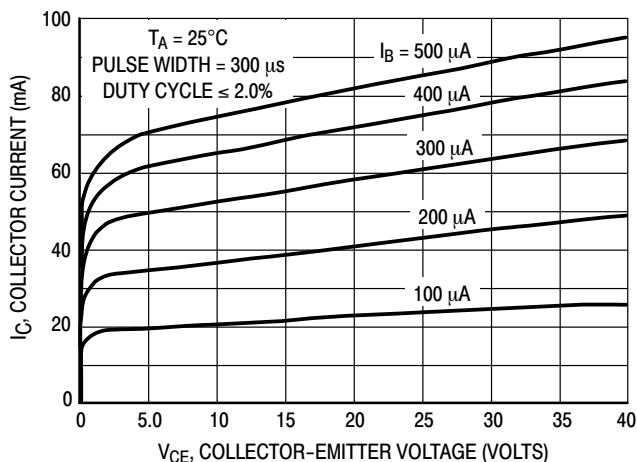

Figure 10. Collector Characteristics

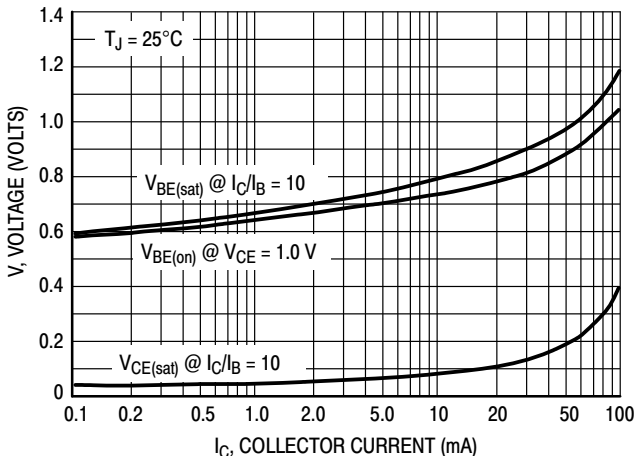

Figure 11. "On" Voltages

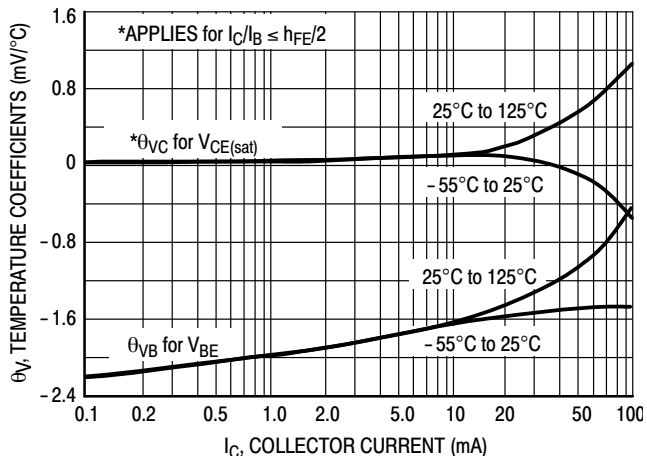

Figure 12. Temperature Coefficients

# BCW72LT1G, SBCW72LT1G

## TYPICAL DYNAMIC CHARACTERISTICS

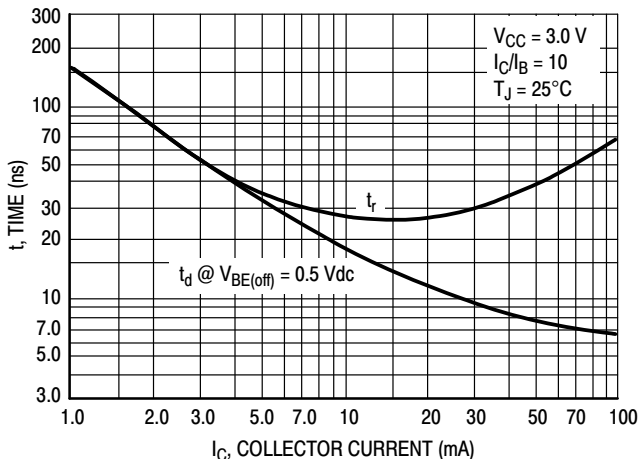

Figure 13. Turn-On Time

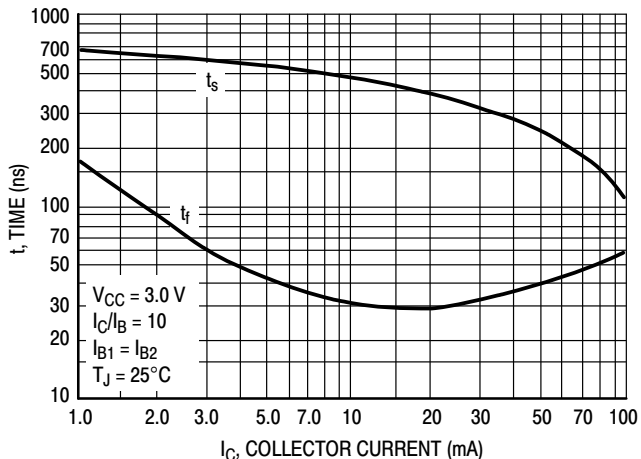

Figure 14. Turn-Off Time

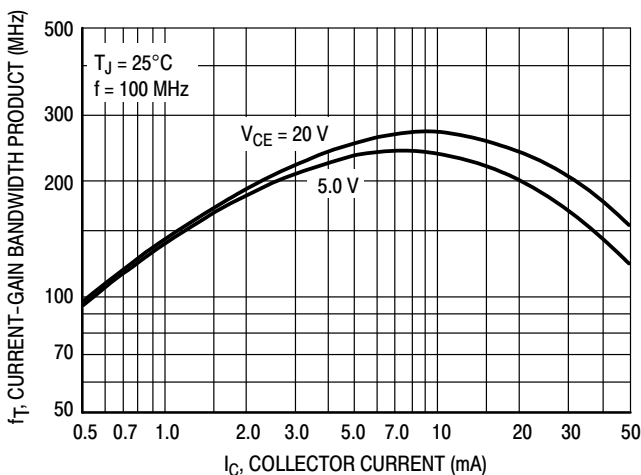

Figure 15. Current-Gain — Bandwidth Product

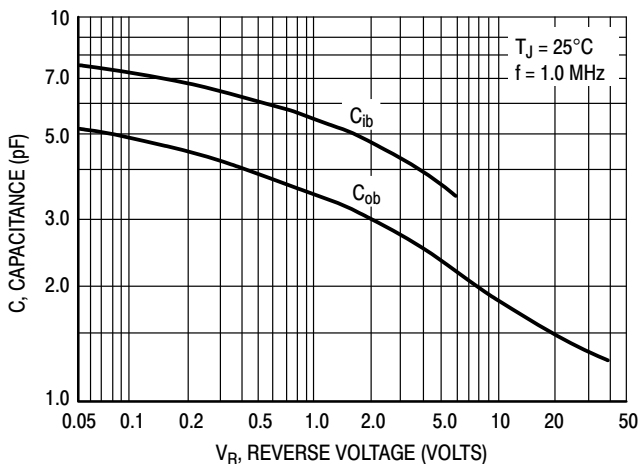

Figure 16. Capacitance

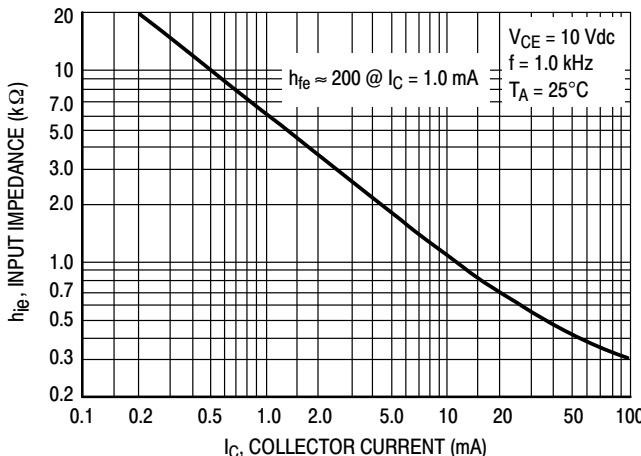

Figure 17. Input Impedance

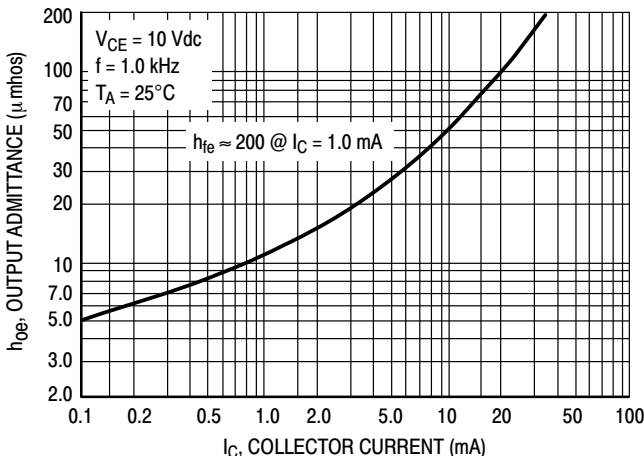

Figure 18. Output Admittance

# BCW72LT1G, SBCW72LT1G

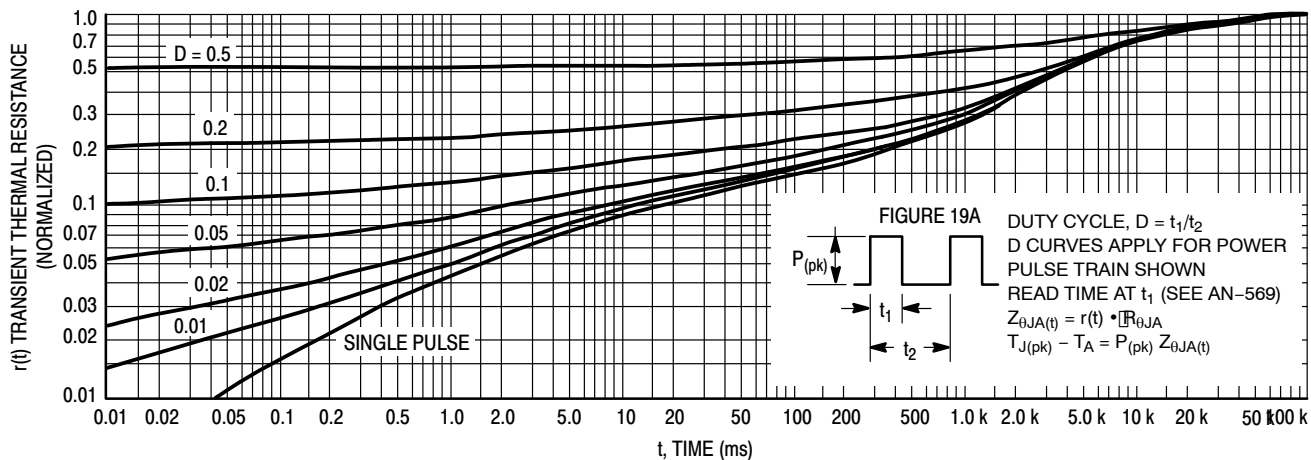

Figure 19. Thermal Response

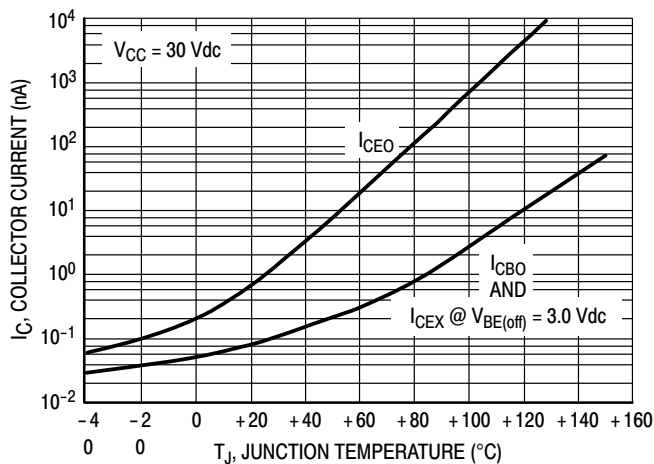

Figure 19A.

## DESIGN NOTE: USE OF THERMAL RESPONSE DATA

A train of periodical power pulses can be represented by the model as shown in Figure 19A. Using the model and the device thermal response the normalized effective transient thermal resistance of Figure 19 was calculated for various duty cycles.

To find  $Z_{\theta JA}(t)$ , multiply the value obtained from Figure 19 by the steady state value  $R_{\theta JA}$ .

Example:

The MPS3904 is dissipating 2.0 watts peak under the following conditions:

$t_1 = 1.0$  ms,  $t_2 = 5.0$  ms. ( $D = 0.2$ )

Using Figure 19 at a pulse width of 1.0 ms and  $D = 0.2$ , the reading of  $r(t)$  is 0.22.

The peak rise in junction temperature is therefore

$$\Delta T = r(t) \times P_{(pk)} \times R_{\theta JA} = 0.22 \times 2.0 \times 200 = 88^\circ\text{C}.$$

For more information, see AN-569.

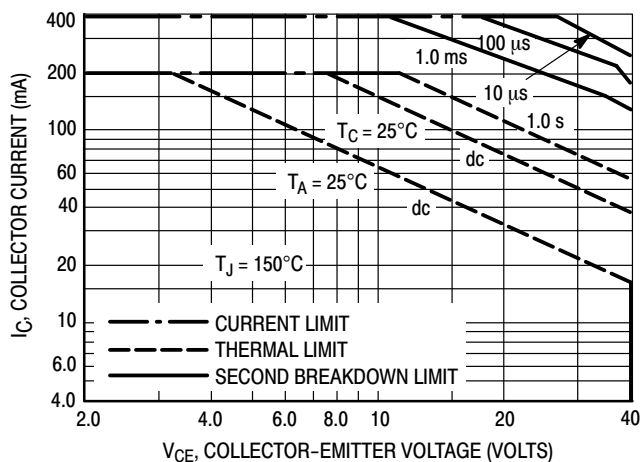

Figure 20.

The safe operating area curves indicate  $I_C$ - $V_{CE}$  limits of the transistor that must be observed for reliable operation. Collector load lines for specific circuits must fall below the limits indicated by the applicable curve.

The data of Figure 20 is based upon  $T_{J(pk)} = 150^\circ\text{C}$ ;  $T_C$  or  $T_A$  is variable depending upon conditions. Pulse curves are valid for duty cycles to 10% provided  $T_{J(pk)} \leq 150^\circ\text{C}$ .  $T_{J(pk)}$  may be calculated from the data in Figure 19. At high case or ambient temperatures, thermal limitations will reduce the power that can be handled to values less than the limitations imposed by second breakdown.

# BCW72LT1G, SBCW72LT1G

## PACKAGE DIMENSIONS

SOT-23 (TO-236)  
CASE 318-08  
ISSUE AP

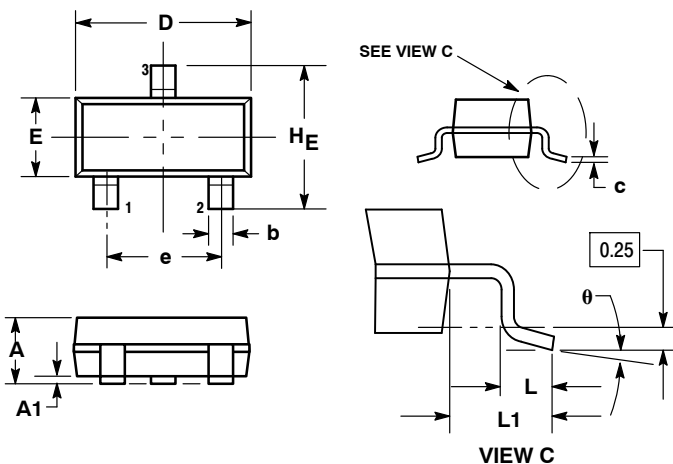

NOTES:

1. DIMENSIONING AND TOLERANCING PER ANSI Y14.5M, 1982.
2. CONTROLLING DIMENSION: INCH.
3. MAXIMUM LEAD THICKNESS INCLUDES LEAD FINISH THICKNESS. MINIMUM LEAD THICKNESS IS THE MINIMUM THICKNESS OF BASE MATERIAL.
4. DIMENSIONS D AND E DO NOT INCLUDE MOLD FLASH, PROTRUSIONS, OR GATE BURRS.

DIM	MILLIMETERS			INCHES		
	MIN	NOM	MAX	MIN	NOM	MAX
A	0.89	1.00	1.11	0.035	0.040	0.044
A1	0.01	0.06	0.10	0.001	0.002	0.004
b	0.37	0.44	0.50	0.015	0.018	0.020
c	0.09	0.13	0.18	0.003	0.005	0.007
D	2.80	2.90	3.04	0.110	0.114	0.120
E	1.20	1.30	1.40	0.047	0.051	0.055
e	1.78	1.90	2.04	0.070	0.075	0.081
L	0.10	0.20	0.30	0.004	0.008	0.012
L1	0.35	0.54	0.69	0.014	0.021	0.029
HE	2.10	2.40	2.64	0.083	0.094	0.104
θ	0°	---	10°	0°	---	10°

STYLE 6:  
PIN 1. BASE  
2. EMITTER  
3. COLLECTOR

### SOLDERING FOOTPRINT

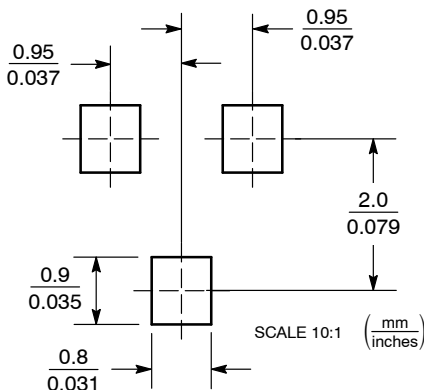

ON Semiconductor and are registered trademarks of Semiconductor Components Industries, LLC (SCILLC). SCILLC reserves the right to make changes without further notice to any products herein. SCILLC makes no warranty, representation or guarantee regarding the suitability of its products for any particular purpose, nor does SCILLC assume any liability arising out of the application or use of any product or circuit, and specifically disclaims any and all liability, including without limitation special, consequential or incidental damages. "Typical" parameters which may be provided in SCILLC data sheets and/or specifications can and do vary in different applications and actual performance may vary over time. All operating parameters, including "Typicals" must be validated for each customer application by customer's technical experts. SCILLC does not convey any license under its patent rights nor the rights of others. SCILLC products are not designed, intended, or authorized for use as components in systems intended for surgical implant into the body, or other applications intended to support or sustain life, or for any other application in which the failure of the SCILLC product could create a situation where personal injury or death may occur. Should Buyer purchase or use SCILLC products for any such unintended or unauthorized application, Buyer shall indemnify and hold SCILLC and its officers, employees, subsidiaries, affiliates, and distributors harmless against all claims, costs, damages, and expenses, and reasonable attorney fees arising out of, directly or indirectly, any claim of personal injury or death associated with such unintended or unauthorized use, even if such claim alleges that SCILLC was negligent regarding the design or manufacture of the part. SCILLC is an Equal Opportunity/Affirmative Action Employer. This literature is subject to all applicable copyright laws and is not for resale in any manner.

### PUBLICATION ORDERING INFORMATION

LITERATURE FULFILLMENT:  
Literature Distribution Center for ON Semiconductor  
P.O. Box 5163, Denver, Colorado 80217 USA  
Phone: 303-675-2175 or 800-344-3860 Toll Free USA/Canada  
Fax: 303-675-2176 or 800-344-3867 Toll Free USA/Canada  
Email: orderlit@onsemi.com

N. American Technical Support: 800-282-9855 Toll Free  
USA/Canada  
Europe, Middle East and Africa Technical Support:  
Phone: 421 33 790 2910  
Japan Customer Focus Center  
Phone: 81-3-5817-1050

ON Semiconductor Website: [www.onsemi.com](http://www.onsemi.com)  
Order Literature: <http://www.onsemi.com/orderlit>

For additional information, please contact your local Sales Representative



Компания «ЭлектроПласт» предлагает заключение долгосрочных отношений при поставках импортных электронных компонентов на взаимовыгодных условиях!

Наши преимущества:

- Оперативные поставки широкого спектра электронных компонентов отечественного и импортного производства напрямую от производителей и с крупнейших мировых складов;
- Поставка более 17-ти миллионов наименований электронных компонентов;
- Поставка сложных, дефицитных, либо снятых с производства позиций;
- Оперативные сроки поставки под заказ (от 5 рабочих дней);
- Экспресс доставка в любую точку России;
- Техническая поддержка проекта, помощь в подборе аналогов, поставка прототипов;
- Система менеджмента качества сертифицирована по Международному стандарту ISO 9001;
- Лицензия ФСБ на осуществление работ с использованием сведений, составляющих государственную тайну;
- Поставка специализированных компонентов (Xilinx, Altera, Analog Devices, Intersil, Interpoint, Microsemi, Aeroflex, Peregrine, Syfer, Eurofarad, Texas Instrument, Miteq, Cobham, E2V, MA-COM, Hittite, Mini-Circuits, General Dynamics и др.);

Помимо этого, одним из направлений компании «ЭлектроПласт» является направление «Источники питания». Мы предлагаем Вам помощь Конструкторского отдела:

- Подбор оптимального решения, техническое обоснование при выборе компонента;
- Подбор аналогов;
- Консультации по применению компонента;
- Поставка образцов и прототипов;
- Техническая поддержка проекта;
- Защита от снятия компонента с производства.



#### Как с нами связаться

**Телефон:** 8 (812) 309 58 32 (многоканальный)

**Факс:** 8 (812) 320-02-42

**Электронная почта:** [org@eplast1.ru](mailto:org@eplast1.ru)

**Адрес:** 198099, г. Санкт-Петербург, ул. Калинина, дом 2, корпус 4, литера А.