

EAO – Your Expert Partner for
Human Machine Interfaces



EAO Product Information

Series 31



Description 3

Product Assembly 4

Devices raised mounting 5

Accessories..... 7

Technical Data..... 12

Typical Applications 15

Application guidelines..... 17

Marking 18

Drawings..... 19

Index..... 27

Indicator round, raised mounting



- 1 Lens
- 2 LED
- 3 Switch housing
- 4 Front plate
- 5 Fixing nut

Illuminated pushbutton rectangular, raised mounting



- 1 Lens
- 2 LED
- 3 Switch housing
- 4 Front plate
- 5 Fixing nut

Product Information

General notes

The series 31 illuminated pushbuttons are equipped with snap-action or low-level switching elements.

Besides the standard contacts (gold-plated silver) silver contacts for switching elements 2.8 mm plug-in terminals can be supplied on request.

The front dimensions of these units are 18 x 24 mm, 18 x 18 mm or 18 mm dia.

In addition to a number of illuminated pushbuttons, the customer can choose from a range of other units and accessories having the same front and mounting dimensions: Indicators, Flashers, Buzzers, etc. (For keylock switches see series 51 or 61.)

Mounting

All switch actuators are mounted from the front by pushing them through the mounting hole in the front panel. They are then fixed from the back with a fixing nut and the mounting tool Typ-Nr. 01-907. Max. tightening torque 50 Ncm.

For switching elements with 2.8 mm plug-in terminals, we offer plug-in bases, which when soldered to a PCB enable a plug-in connection to the button. The rectangular actuators are provided with an anti-twisting device.

Lenses

The flat or concave lenses, made of Polymethyl Methacrylate, are available in various colours, as well as translucent or transparent.

Marking

For further information about engraving, hot stamping and film inserts see part Marking.

Illumination

The T1 ³/₄ Midget Groove incandescent (filament) lamp (6 ... 48 V) ensures perfect illumination of the lenses, which are supplied in various colours.

T1 ³/₄ Midget Groove Single-LED (6, 12, 24, 28, 48 V) are also available in blue, green, red, white or yellow.

Luminosity and wave length scattering caused by the technology used in the LED manufacturing processes may lead to visual differences in our products.

For supply voltages above 48 V, it is necessary to use a voltage reduction element (external series resistor or transformer).

Position indication

The status of a maintained action switch can be determined by the position of the lens.

Specimen order

Indicator :

- | | |
|--|------------|
| - Indicator actuator, 18 x 24 mm, soldering terminal | 31-040.005 |
|--|------------|

Essential accessories :

- | | |
|--|--------------|
| - Lens plastic blue, transparent, flush, 18 x 24 mm | 31-903.6 |
| - Single-LED, T1 ³ / ₄ MG, 24 VAC/DC, blau | 10-2J12.1066 |

*We reserve the right to modify technical data
All dimensions in mm*

Indicator actuator



Essential Accessories:

- Lens plastic page 7
- Single-LED page 10

	Front protection	Diode (1N 4007)	Terminals	\varnothing 18 x 18 mm Typ-Nr.	\varnothing 18 x 24 mm Typ-Nr.	\varnothing 18 mm Typ-Nr.	Component layout	Mounting dimensions	Technical drawing	Circuit drawing	
Indicator actuator	IP 40	1 D	UT	31-703.006	31-701.006		4	1	7	33	0.006
		2 D	UT	31-704.006	31-702.006		4	1	7	34	0.006
	-	S		31-050.005	31-040.005	31-030.005		1	7	4	0.004
		S1		31-050.002	31-040.002	31-030.002		1	7	3	0.004
		UT		31-051.006	31-041.006	31-031.006		4	1	7	3

Diode (1N 4007): D = Diode, - = without

Terminals: UT = Universal terminal, S = Soldering terminal, S1 = Soldering terminal (also pluggable 2.8 x 0.5 mm)

Component layout from page 19, Mounting dimensions from page 20, Technical drawing from page 20, Circuit drawing from page 22

Buzzer



	Front protection	Front cap	Terminals	\varnothing 18 x 24 mm Typ-Nr.	Mounting dimensions	Technical drawing	Circuit drawing	
Buzzer Operation voltage : 10 ... 26 VDC	IP 40	Plastic black	S1	31-801.002	1	3	1	0.015
Operation voltage : 10 ... 55 VAC, 10 ... 75 VDC	IP 40	Plastic black	S	31-810.005	1	3	2	0.015

Further information in the Technical Data and Typical Applications

Terminals: S1 = Soldering terminal (also pluggable 2.8 x 0.5 mm), S = Soldering terminal

Mounting dimensions from page 20, Technical drawing from page 20, Circuit drawing from page 22

Illuminated pushbutton actuator



Essential Accessories:

- Lens plastic page 7
- Single-LED page 10

	Front protection	Switching system	Contacts	Diode (1N 4007)	Switching action	Terminals				Component layout	Mounting dimensions	Technical drawing	Circuit drawing			
							∅ 18 x 18 mm Typ-Nr.	∅ 18 x 24 mm Typ-Nr.	∅ 18 mm Typ-Nr.							
Illuminated pushbutton actuator	IP 40	LL	1 NC	-	MA	UT	31-486.036	31-466.036	31-476.036	4	1	8	14	0.007		
					M	UT	31-456.036	31-426.036	31-436.036	4	1	8	28	0.007		
			1 NC + 1 NO	-	MA	UT	31-483.036	31-463.036	31-473.036	4	1	8	17	0.007		
					M	UT	31-453.036	31-423.036	31-433.036	4	1	8	31	0.007		
			1 NO	-	MA	UT	31-485.036	31-465.036	31-475.036	4	1	8	16	0.007		
					M	UT	31-455.036	31-425.036	31-435.036	4	1	8	30	0.007		
			2 NC	-	MA	UT	31-482.036	31-462.036	31-472.036	4	1	8	15	0.007		
					M	UT	31-452.036	31-422.036	31-432.036	4	1	8	29	0.007		
			2 NO	-	MA	UT	31-481.036	31-461.036	31-471.036	4	1	8	18	0.007		
					M	UT	31-451.036	31-421.036	31-431.036	4	1	8	32	0.007		
			SA	1 NC + 1 NO	1 D		MA	UT	31-717.0292	31-713.0292	31-747.0292	4	1	8	11	0.008
							M	UT	31-709.0292	31-705.0292	31-743.0292	4	1	8	25	0.008
					2 D		MA	UT	31-718.0292	31-714.0292	31-748.0292	4	1	8	12	0.008
							M	UT	31-710.0292	31-706.0292	31-744.0292	4	1	8	26	0.008
		-				MA	S	31-281.0252	31-261.0252	31-271.0252		1	8	13	0.006	
								S1	31-281.022	31-261.022	31-271.022		1	8	10	0.006
						M	S	31-151.0252	31-121.0252	31-131.0252		1	8	27	0.006	
								S1	31-151.022	31-121.022	31-131.022		1	8	24	0.006
		2 NC + 2 NO			1 D		MA	UT	31-719.0292	31-715.0292	31-749.0292	4	1	8	7	0.010
							M	UT	31-711.0292	31-707.0292	31-745.0292	4	1	8	21	0.010
					2 D		MA	UT	31-720.0292	31-716.0292	31-750.0292	4	1	8	8	0.010
							M	UT	31-712.0292	31-708.0292	31-746.0292	4	1	8	22	0.010
					-		MA	S	31-282.0252	31-262.0252	31-272.0252		1	8	9	0.008
									S	31-152.0252	31-122.0252	31-132.0252		1	8	23
		3 NC + 3 NO			-		MA	S	31-283.0252	31-263.0252	31-273.0252		1	8	6	0.010
							M	S	31-153.0252	31-123.0252	31-133.0252		1	8	20	0.010
		4 NC + 4 NO			-		MA	S	31-284.0252	31-264.0252	31-274.0252		1	8	5	0.012
							M	S	31-154.0252	31-124.0252	31-134.0252		1	8	19	0.012

Power rating: Low level switching element 42 V, 100 mA; Snap action switching element 250 V, 5 A

Switching system: LL = Low level switching element, SA = Snap-action switching element

Contacts: NC = Normally closed, NO = Normally open

Diode (1N 4007): - = without, D = Diode

Switching action: MA = Maintained action, M = Momentary action

Terminals: UT = Universal terminal, S = Soldering terminal, S1 = Soldering terminal (also pluggable 2.8 x 0.5 mm)

Component layout from page 19, Mounting dimensions from page 20, Technical drawing from page 20, Circuit drawing from page 22

Front

Lens plastic

	Lens	∅ 18 x 18 mm Typ-Nr.	∅ 18 x 24 mm Typ-Nr.	∅ 18 mm Typ-Nr.	
Lens plastic concave, illuminative	blue transparent	31-954.6	31-904.6		0.001
	colourless transparent	31-954.7	31-904.7		0.001
	green transparent	31-954.5	31-904.5		0.001
	orange transparent	31-954.3	31-904.3		0.001
	red transparent	31-954.2	31-904.2		0.001
	yellow transparent	31-954.4	31-904.4		0.001
concave, non-illuminative	black opaque	31-952.0	31-902.0		0.001
	grey opaque		31-902.8		0.001
flush, illuminative	blue transparent	31-953.6	31-903.6	31-933.6	0.001
	colourless transparent	31-953.7	31-903.7	31-933.7	0.001
	green transparent	31-953.5	31-903.5	31-933.5	0.001
	orange transparent	31-953.3	31-903.3	31-933.3	0.001
	red transparent	31-953.2	31-903.2	31-933.2	0.001
	smoked transparent	31-953.1	31-903.1	31-933.1	0.001
	yellow transparent	31-953.4	31-903.4	31-933.4	0.001
	flush, illuminative (not recommended for film insert)	blue translucent	31-951.6	31-901.6	31-931.6
colourless transparent		31-955.7	31-905.7	31-935.7	0.001
green translucent		31-951.5	31-901.5	31-931.5	0.001
green transparent		31-955.5	31-905.5	31-935.5	0.001
orange translucent		31-951.3	31-901.3	31-931.3	0.001
red translucent		31-951.2	31-901.2	31-931.2	0.001
red transparent		31-955.2	31-905.2	31-935.2	0.001
white translucent		31-951.9	31-901.9	31-931.9	0.001
yellow translucent		31-951.4	31-901.4	31-931.4	0.001
yellow transparent		31-955.4	31-905.4	31-935.4	0.001
flush, non-illuminative		black opaque	31-951.0	31-901.0	31-931.0
	grey opaque	31-951.8	31-901.8	31-931.8	0.001



Protective cover

	∅ 18 x 18 mm Typ-Nr.	∅ 18 x 24 mm Typ-Nr.	Technical drawing	
Protective cover hinged, transparent, with means for sealing	31-920		5	0.002
		31-925	6	0.002



Technical drawing from page 20

Front protective cap

front protection IP 67

		∅ 18 x 18 mm Typ-Nr.	∅ 18 x 24 mm Typ-Nr.	Mounting dimensions	Technical drawing	
	Front protective cap					
Front protective cap two-part	PVC	31-923		2	4	0.003
	Silikon		31-924.2	2	4	0.003



Mounting dimensions from page 20, Technical drawing from page 20

Protective guard

matt chromium-plated

		Typ-Nr.	Technical drawing	
Protective guard broad sides bent upwards		01-927	2	0.011
narrow ends bent upwards		01-926	1	0.011



Technical drawing from page 20

Blind plug

		∅ 18 x 18 mm Typ-Nr.	∅ 18 x 24 mm Typ-Nr.	∅ 18 mm Typ-Nr.	Mounting dimensions	
	Blind plug					
Blind plug	Plastic black	01-948.0	01-947.0	01-949.0	1	0.001



Mounting dimensions from page 20

Backside

PCB plug-in base

	Terminals	Typ-Nr.	Component layout	
PCB plug-in base 16.4 mm dia. x 9.8 mm for Low level switching element, Pins axial	P	31-940	2	0.002
17.8 x 12.9 mm x 9.8 mm for Snap-action switching element 2.8 mm, Pins axial	P	31-942	3	0.002
17.9 x 17.9 x 8.4 mm for Low level switching element, Pins bent at right-angle	P	31-941	1	0.004



PCB plug-in base Pins right-angle : With the extendable mounting the distance between plug-in base and PCB can be varied up to 3 mm.

Terminals: P = PCB terminal

Component layout from page 19

Flat receptacle

	Typ-Nr.	
Flat receptacle 2.0 x 0.5 mm for Universal terminal	31-945	0.001
2.8 x 0.5 mm for Plug-in terminal	31-946	0.001



Insulation sleeve

	Typ-Nr.	
Insulation sleeve Cover Plug-in terminals for snap-action switching element 2.8 mm	01-928	0.001
for Flat receptacle 31-945	31-928	0.001
for Flat receptacle 31-946	31-929	0.001



Terminal cover

	Typ-Nr.	
Terminal cover	01-929	0.010



Illumination

Filament lamp

	Socket	Operating voltage/-current	Typ-Nr.	
Filament lamp	T1 3/4 MG	12 VAC/DC, 75 mA	10-1309.1309	0.001
		14 VAC/DC, 80 mA	10-1310.1319	0.001
		18 VAC/DC, 40 mA	10-1311.1249	0.001
		24 VAC/DC, 35 mA	10-1312.1229	0.001
		28 VAC/DC, 30 mA	10-1313.1209	0.001
		28 VAC/DC, 40 mA	10-1313.1249	0.001
		36 VAC/DC, 20 mA	10-1316.1179	0.001
		36 VAC/DC, 30 mA	10-1316.1209	0.001
		48 VAC/DC, 20 mA	10-1319.1179	0.001
		48 VAC/DC, 25 mA	10-1319.1199	0.001
		6 VAC/DC, 120 mA	10-1306.1349	0.001
		6.3 VAC/DC, 200 mA	10-1307.1369	0.001



Single-LED

	Socket	Light colour	Operating voltage/-current	Typ-Nr.	
Single-LED	T1 3/4 MG	blue	12 VAC/DC, 7/14 mA	10-2J09.1066	0.002
			24 VAC/DC, 7/14 mA	10-2J12.1066	0.002
			28 VAC/DC, 7/14 mA	10-2J13.1066	0.002
			48 VAC/DC, 4/8 mA	10-2J19.1046	0.002
			6 VDC, 15 mA	10-2J06.3146	0.002
		green	12 VAC/DC, 4/7 mA	10-2J09.1065	0.002
			24 VAC/DC, 4/7 mA	10-2J12.1065	0.002
			28 VAC/DC, 4/7 mA	10-2J13.1065	0.002
			48 VAC/DC, 2/4 mA	10-2J19.1045	0.002
			6 VDC, 7 mA	10-2J06.3145	0.002
		red	12 VAC/DC, 7/14 mA	10-2J09.1062	0.002
			24 VAC/DC, 7/14 mA	10-2J12.1062	0.002
			28 VAC/DC, 7/14 mA	10-2J13.1062	0.002
			48 VAC/DC, 4/8 mA	10-2J19.1042	0.002
			6 VDC, 15 mA	10-2J06.3142	0.002
		white diffuse	12 VAC/DC, 7/14 mA	10-2J09.1069	0.002
			24 VAC/DC, 7/14 mA	10-2J12.1069	0.002
			28 VAC/DC, 7/14 mA	10-2J13.1069	0.002
			48 VAC/DC, 4/8 mA	10-2J19.1049	0.002
			6 VDC, 15 mA	10-2J06.3149	0.002
		yellow	12 VAC/DC, 7/14 mA	10-2J09.1064	0.002
			24 VAC/DC, 7/14 mA	10-2J12.1064	0.002
			28 VAC/DC, 7/14 mA	10-2J13.1064	0.002
			48 VAC/DC, 4/8 mA	10-2J19.1044	0.002
			6 VDC, 15 mA	10-2J06.3144	0.002



Note:
AC operation through halve-wave rectifier possible, slight flickering can occur.

Series resistor

for lamp voltage reduction

	Operating voltage	Typ-Nr.	
Series resistor 10 kΩ, for filament lamp 48 VAC, 25 mA	230/240 V	02-904.7	0.003
2.7 kΩ, for filament lamp 48 VAC, 25 mA	110 V	02-904.0	0.003
3.3 kΩ, for filament lamp 48 VAC, 25 mA	125 V	02-904.1	0.003
4.7 kΩ, for filament lamp 48 VAC, 25 mA	145 V	02-904.3	0.003



Please keep to the country specific security rules.

Terminal plate empty

for fitting with series resistors

	Typ-Nr.	
Terminal plate empty 10 spaces 125 x 60 x 15 mm	02-912.2	0.045
15 spaces 187.5 x 60 x 15 mm	02-912.3	0.090
5 spaces 62.5 x 60 x 15 mm	02-912.1	0.025



Assembling

Lens remover

	Typ-Nr.	
Lens remover	02-905	0.011



Lamp remover

	Typ-Nr.	
Lamp remover	61-9740.0	0.003



CAUTION

A switching process might be released when replacing the lamp/LED !

Mounting tool

	Typ-Nr.	
Mounting tool for Indicator 16 mm dia.	01-907	0.020



Dressing tool

for aligning buttons

	Typ-Nr.	
Dressing tool	01-906	0.030



Actuator with snap-action switching element

Switching system

Self-cleaning, double-break, snap action switching system (with contact gap 2 x 0.5 mm).
 1 Normally closed or 1 Normally open contact per element.
 Snap-action switching elements with soldering terminals at the sides: Up to 4 switching element can be on a pushbutton (max. 4 Normally closed and 4 Normally open contacts).
 Snap-action switching element with axial plug-in terminals 2.8 mm stachable, only 1 switching element can be on a pushbutton.

Material

Material of contact

Gold plated silver

Switch housing

Axial plug-in/soldering terminal 2.8 mm:
 Diallylphthalate (DAP), Polyamide (PA66), Polysulfone, heat-resistant and self-extinguishing
 Soldering terminal: PA 6.6 Ultramide

Actuator housing

Polyetherimide, self-extinguishing

Mechanical characteristics

Terminals

Snap-action switching element with tinned soldering terminals at the sides:
 Max. wire diameter 2 wires à 1.2 mm
 Max. wire cross-section of stranded cable 1 x 1 mm²
 Snap-action switching element with axial plug-in terminals, which can also be used as soldering terminals: Plug-in terminal 2.8 x 0.5 mm

Soldering terminal:

Max. wire diameter 1 wire of 1.5 mm²
 Max. wire cross-section of stranded cable 2 x 0.75 mm² or 1 x 1.0 mm²

Actuating force

2 N ... 5.5 N, depending on the number of switching elements

Actuating travel

3 mm

Rebound time

≤5ms

Mechanical lifetime

Momentary action 2 million cycles of operation
 Maintained action 1 million cycles of operation

Electrical characteristics

Standards

IEC 61058, EN 61058

Rated voltage

250 VAC/VDC

Rated current

5 A

Contact resistance

Starting value (initial) ≤50 mΩ

Conventional free air thermal current

5 A

The maximum current in continuous operation and at ambient temperature not exceeding the quoted maximum values.

Switch rating

250 VAC, 5 A (cosφ 1)
 250 VAC, 3 A (cosφ 0,3)

Switch rating AC (cosφ 0,7)

Voltage	125 VAC	250 VAC
Current	3 A	2 A

Switch rating DC (inductive) L:R = 30 ms

Voltage	24 VDC	60 VDC	110 VDC	220 VDC
Current	2 A	0.7 A	0.2 A	0.1 A

Electric strength

2500 VAC, 50 Hz, 1 min. between all terminals and earth, as per IEC 60512-2-11

Protection class

II

Environmental conditions

Storage temperature

-40 °C ... +85 °C

Service temperature

-25 °C ... +55 °C

For indicators and illuminated pushbuttons mounted as a block, make sure the heat can escape freely.

Protection degree

Front as per:
 IP 40
 IP 65 with spray cover

Shock resistance

(Single impacts, semi-sinusoidal)
 15 g for 11 ms, as per IEC 60512-4-3, IEC 60068-2-27

Vibration resistance

(sinusoidal)
 10 g at 0-2000 Hz, amplitude 1.5 mm, as per IEC 60512-4-4, IEC 60068-2-6

Climate resistance

Standard condition, as per IEC 60068-2-3 and 2-30
 Changing condition, as per IEC 60068-2-14 and 2-33

Approvals

Approbations

CB (IEC 61058)
 CSA
 ENEC (EN 61058)
 Germanischer Lloyd
 UL

Declaration of conformity

CE

Actuator with low level switching element

Switching system

This low level switching element was designed for switching low powers in electronic circuits. The mechanism assures reliable switching of loads ranging from a few $\mu\text{A}/\mu\text{V}$ up to 100 mA/42 VAC/DC.

Single-break momentary contact, as normally open or normally closed with 4 independent points of contact. 2 momentary contacts per switching element; combination of normally open and normally closed is possible.

Special features are the long life, extremely short rebound time and stable contact resistance.

Material

Material of contact

Gold plated

Switch housing

Polysulfone, heat-resistant and self-extinguishing

Actuator housing

Polyetherimide, self-extinguishing

Mechanical characteristics

Terminals

The universal terminals permit these units to be mounted on printed circuit boards (PCB). These terminals can also be used as soldering or plug-in terminals.

For these terminals we can also supply a plug-in base which, when soldered on to the board, enables the switch to be plugged in.

Soldering terminal:

Max. wire diameter 2 wires à 0.8 mm

Max. wire cross-section of stranded cable 1x 0.75 mm²

Plug-in terminal: 2.0 x 0.5 mm

Actuating force

3 N ... 3,5 N

Actuating travel

3 mm

Rebound time

Typ. <100 μs

Mechanical lifetime

Momentary action 5 million cycles of operation

Maintained action 1 million cycles of operation

Electrical characteristics

Standards

EN 61058

Contact resistance

Starting value (initial) $\leq 50 \text{ m}\Omega$

Switch rating

10 μA , 100 μV to 100 mA at 42 VAC/VDC

Electric strength

2500 VAC, 50 Hz, 1 min. between all terminals and earth, as per IEC 60512-2-11

Protection class

II

Environmental conditions

Storage temperature

-40 °C ... +85 °C

Service temperature

-25 °C ... +55 °C

For indicators and illuminated pushbuttons mounted as a block, make sure the heat can escape freely.

Protection degree

Front as per:

IP 40

IP 65 with spray cover

Shock resistance

(Single impacts, semi-sinusoidal)

15 g for 11 ms, as per IEC 60512-4-3, IEC 60068-2-27

Vibration resistance

(sinusoidal)

10 g at 0-2000 Hz, amplitude 1.5 mm, as per IEC 60512-4-4, IEC 60068-2-6

Climate resistance

Standard condition, as per IEC 60068-2-3 and 2-30

Changing condition, as per IEC 60068-2-14 and 2-33

Buzzer Typ-Nr. 31-810.005

Switching system

Buzzer system

Electronic non-contacting buzzer
with IC oscillator

Material

Alarm buzzer case

Polyetherimide

Front bezel

Polyamide

Mechanical characteristics

Terminals

Soldering terminal

Electrical characteristics

Frequency (tone)

Approx. 2.8 kHz

Interval frequency

approx. 3 Hz

Sound pressure

88 dB (A) \pm 8 dB at a distance of 0.1 m
Volume variable with a 1 M Ω potentiometer or corresponding fixed resistor

Operation Voltage/Current

Typ. 10 VAC ... 55 VAC, 25 mA
Typ. 10 VDC ... 75 VDC, 15 mA

Environmental conditions

Storage temperature

-40 °C ... +85 °C

Service temperature

-25 °C ... +55 °C

Protection degree

IP 40

Approvals

Approbations

Germanischer Lloyd

Declaration of conformity

CE

Buzzer Typ-Nr. 31-801.002

Switching system

Buzzer system

Electronic non-contacting buzzer
with IC oscillator

Material

Alarm buzzer case

Polyetherimide

Front bezel

Polyamide

Mechanical characteristics

Terminals

Plug-in terminal 2.8 x 0.5 mm

Electrical characteristics

Frequency (tone)

ca. 2.0 kHz

Interval frequency

2 Hz

Sound pressure

88 db (A) \pm 8 dB at a distance of 0.1 m

Operation Voltage/Current

10 VDC ... 26 VDC, \leq 20 mA

Environmental conditions

Storage temperature

-40 °C ... +85 °C

Service temperature

-25 °C ... +55 °C

Protection degree

IP 40

Approvals

Approbations

Germanischer Lloyd

Declaration of conformity

CE

Diode element

When indicators and illuminated pushbuttons equipped with diodes, the user is able to perform a lamp check or wire an alarm circuit simply with a considerable saving of space.

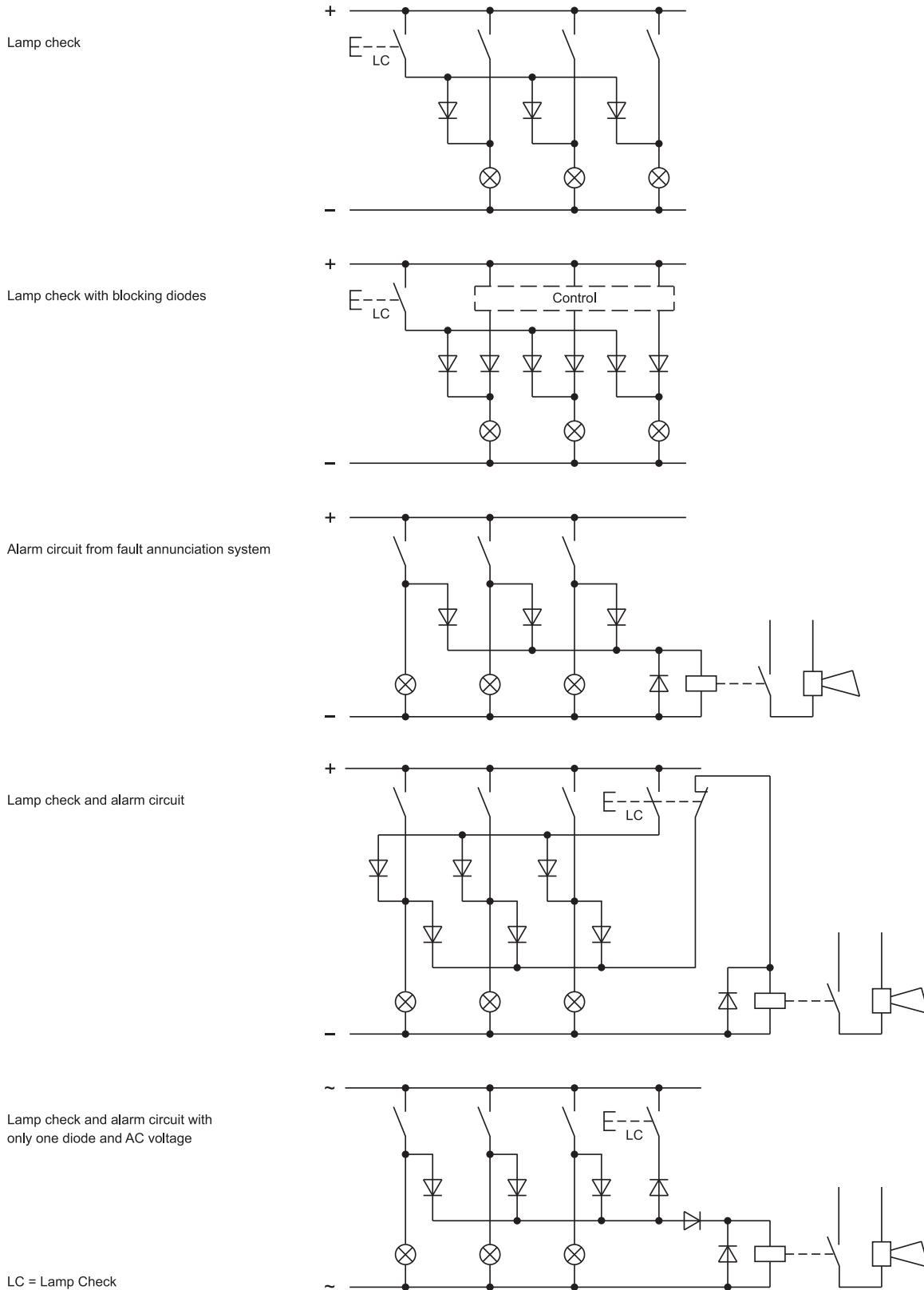

Buzzer (31-801.002)

Depending on how terminals are connected, the buzzer can operate with a continuous tone a(-) b(+) or with intermittent tone a(+) b(-).

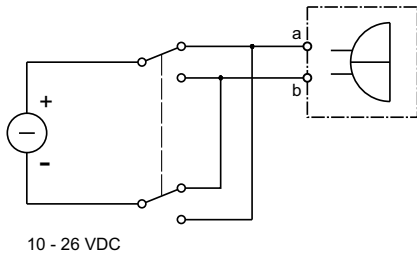

10 - 26 VDC

Buzzer (31-810.005)



1. Supply voltage I
Continuous tone
U = 10 - 35 VAC
U = 10 - 50 VDC

2. Supply voltage II
Continuous tone
U = 35 - 55 VAC
U = 35 - 75 VDC

3. Intermittent tone
Interval aprox. 3 Hz

4. Volume control

Suppressor circuits

When switching inductive loads such as relays, DC motors, and DC solenoids, it is always important to absorb surges (e.g. with a diode) to protect the contacts. When these inductive loads are switched off, a counter emf can severely damage switch contacts and greatly shorten lifetime.

Fig. 1 shows an inductive load with a free-wheeling diode connected in parallel. This free-wheeling diode provides a path for the inductor current to flow when the current is interrupted by the switch. Without this free-wheeling diode, the voltage across the coil will be limited only by dielectric breakdown voltages of the circuit or parasitic elements of the coil. This voltage can be kilovolts in amplitude even when nominal circuit voltages are low (e.g. 12 VDC) see Fig. 2.

The free-wheeling diode should be chosen so that the reverse breakdown voltage is greater than the voltage driving the inductive load. The DC blocking voltage (V_R) of the free-wheeling diode can be found in the datasheet of a diode. The forward current should be equal or greater than the maximum current flowing through the load.

To get an efficient protection, the free-wheeling diode must be connected as close as possible to the inductive load!

Switching with inductive load
Fig. 1



Counter emf
over load without free-wheeling diode
Fig. 2



General notes

1. Engraving

In addition to the most commonly used world languages, in DIN 1451-3 close spacing, other typefaces are available as Scandinavian, Slavic, Greek, Russian and Polish.

Red, blue and black lenses are filled with white colour. Other colour lenses are filled in black. Standard height of letters is 2 mm. If the height is not specified, we will supply 2 mm engraved letters.

2. Hot stamping

For larger series it is worth considering markings by means of hot stamping. We will be pleased to advise you.

For letters and figures, typefaces with 2.5 mm, 3 mm and 4 mm are available.

3. Film inserts

Instead of using engraving the lenses can be fitted with transparent film inserts, as an alternative. For this purpose, though, it is advisable to use transparent lenses.

In the case of use of a smoke-black lens the fitted film becomes readable only if the lamp is on.

To insert the film, the feet of the lens holder have to be pushed together far enough to enable the lens to be lifted off easily.

The film thickness is 0.2 mm.

Important : Consider pushbutton mounting orientation before specifying engraving characters !

All dimensions in mm

Front size (Lens)	Film insert max. size	Height of letters h	Number of lines	Number of (target value) capital letters per line	Number of (target value) small letters per line	Image
18 dia. (15.8 dia.)	12.8 dia.	2.5	3	6	6	B4
		3.0	2	5	6	B4
		4.0	2	3	4	B4
		5.0	1	2	3	B4
		6.0	1	2	2	B4
18 x 18 (15.2 x 15.2)	12.7 x 12.7	2.5	4	7 - 8	8	B3
		3.0	3	6 - 7	7	B3
		4.0	2	4 - 5	5	B3
		5.0	2	3 - 4	4	B3
		6.0	1	3	3 - 4	B3
18 x 24 (15.2 x 21.2)	12.7 x 18.7	2.5	4	11	12	B1
			5	7 - 8	8	B2
		3.0	3	9 - 10	10 - 11	B1
			4	6 - 7	7	B2
		4.0	2	7	7 - 8	B1
			3	4 - 5	5	B2
		5.0	2	5 - 6	6	B1
				3 - 4	4	B2
		6.0	1	4 - 5	5	B1
				3	3 - 4	B2
8.0	1	3 - 4	3 - 4	B1		
		2 - 3	2 - 3	B2		

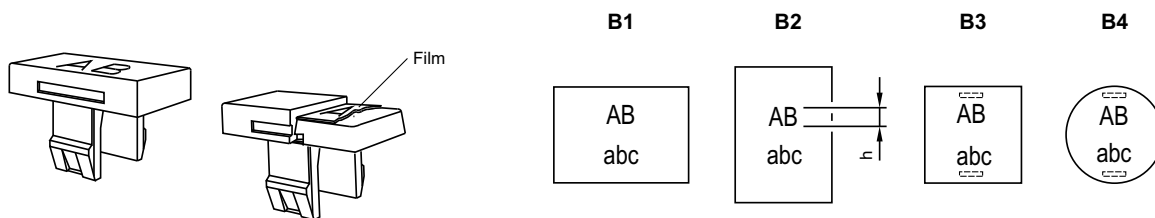

Component layout

1 PCB plug-in base page 9



2 PCB plug-in base page 9



3 PCB plug-in base page 9



4 Indicator actuator page 5 | Illuminated pushbutton actuator page 6

Terminals (rearside)

PCB layout (conductor side)



Mounting dimensions

1 Indicator actuator page 5 | Buzzer page 5 | Illuminated pushbutton actuator page 6 | Blind plug page 8

18 x 18 mm

18 x 24 mm

Ø18 mm



2 Front protective cap page 8

18 x 18 mm

18 x 24 mm



Technical drawing

1 Protective guard page 8



2 Protective guard page 8

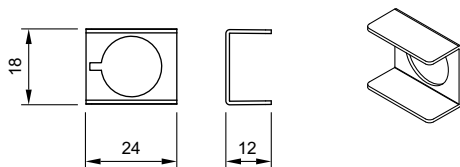

3 Buzzer page 5



4 Front protective cap page 8



5 Protective cover page 7

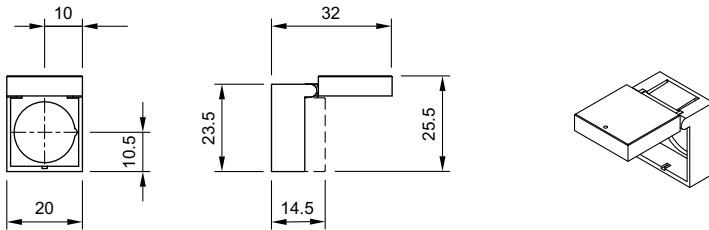

6 Protective cover page 7

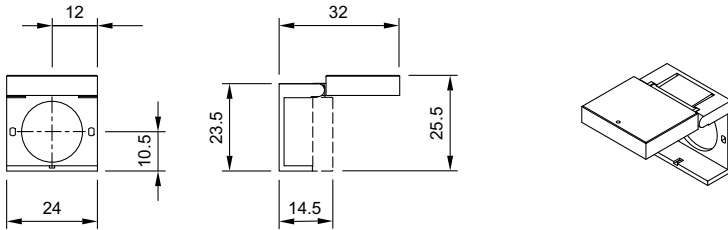

7 Indicator actuator page 5



Soldering terminal	Soldering terminal (also pluggable)	Universal terminal	Universal terminal + diodes
L	L1	U	U+D
23.5	26.5	36	-
1D, 2D			36

8 Illuminated pushbutton actuator page 6



	Soldering terminal	Soldering terminal (also pluggable)	Universal terminal	Universal terminal + diode
1NC+1NO	29	36	-	-
2NC+2NO	36.5	-	-	-
3NC+3NO	44	-	-	-
4NC+4NO	51.5	-	-	-
1NC+1NO+D	-	-	-	43.5
2NC+2NO+D	-	-	-	51
1NC, 1NO, 1NC+1NO, 2NC, 2NO	36	-	-	-

Circuit drawing

1 Buzzer page 5



2 Buzzer page 5



3 Indicator actuator page 5



4 Indicator actuator page 5



5 Illuminated pushbutton actuator page 6

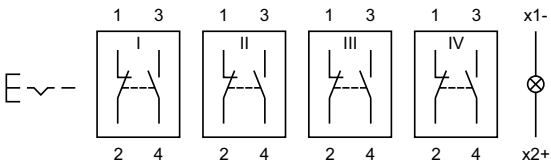

6 Illuminated pushbutton actuator page 6

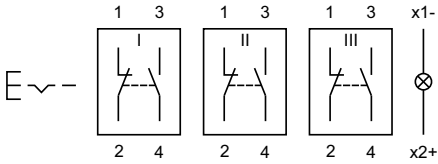

7 Illuminated pushbutton actuator page 6



8 Illuminated pushbutton actuator page 6



9 Illuminated pushbutton actuator page 6



10 Illuminated pushbutton actuator page 6



11 Illuminated pushbutton actuator page 6



12 Illuminated pushbutton actuator page 6



13 Illuminated pushbutton actuator page 6

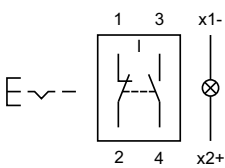

14 Illuminated pushbutton actuator page 6



15 Illuminated pushbutton actuator page 6



16 Illuminated pushbutton actuator page 6

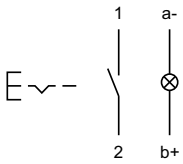

17 Illuminated pushbutton actuator page 6

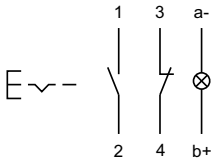

18 Illuminated pushbutton actuator page 6

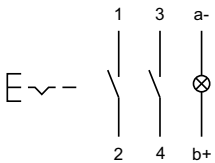

19 Illuminated pushbutton actuator page 6

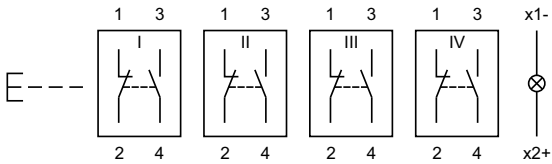

20 Illuminated pushbutton actuator page 6

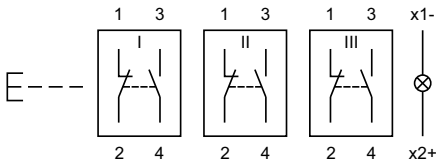

21 Illuminated pushbutton actuator page 6

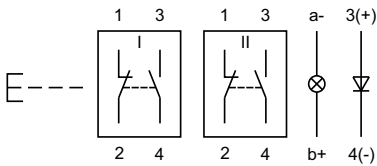

22 Illuminated pushbutton actuator page 6

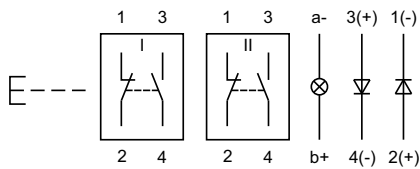

23 Illuminated pushbutton actuator page 6

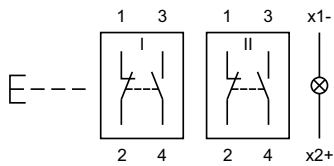

24 Illuminated pushbutton actuator page 6

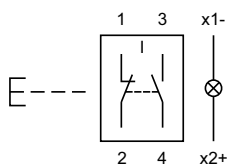

25 Illuminated pushbutton actuator page 6

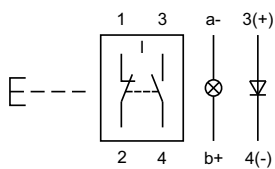

26 Illuminated pushbutton actuator page 6

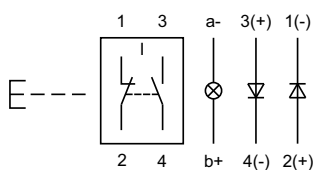

27 Illuminated pushbutton actuator page 6

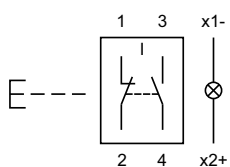

28 Illuminated pushbutton actuator page 6

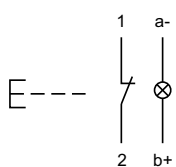

29 Illuminated pushbutton actuator page 6

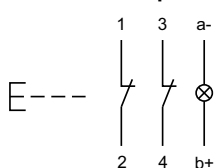

30 Illuminated pushbutton actuator page 6



31 Illuminated pushbutton actuator page 6



32 Illuminated pushbutton actuator page 6



33 Indicator actuator page 5



34 Indicator actuator page 5



Index from Typ-Nr.

Typ-Nr.	Page	Typ-Nr.	Page	Typ-Nr.	Page
01-906	11	31-121.022	6	31-704.006	5
01-907	11	31-121.0252	6	31-705.0292	6
01-926	8	31-122.0252	6	31-706.0292	6
01-927	8	31-123.0252	6	31-707.0292	6
01-928	9	31-124.0252	6	31-708.0292	6
01-929	9	31-131.022	6	31-709.0292	6
01-947.0	8	31-131.0252	6	31-710.0292	6
01-948.0	8	31-132.0252	6	31-711.0292	6
01-949.0	8	31-133.0252	6	31-712.0292	6
02-904.0	11	31-134.0252	6	31-713.0292	6
02-904.1	11	31-151.022	6	31-714.0292	6
02-904.3	11	31-151.0252	6	31-715.0292	6
02-904.7	11	31-152.0252	6	31-716.0292	6
02-905	11	31-153.0252	6	31-717.0292	6
02-912.1	11	31-154.0252	6	31-718.0292	6
02-912.2	11	31-261.022	6	31-719.0292	6
02-912.3	11	31-261.0252	6	31-720.0292	6
10-1306.1349	10	31-262.0252	6	31-743.0292	6
10-1307.1369	10	31-263.0252	6	31-744.0292	6
10-1309.1309	10	31-264.0252	6	31-745.0292	6
10-1310.1319	10	31-271.022	6	31-746.0292	6
10-1311.1249	10	31-271.0252	6	31-747.0292	6
10-1312.1229	10	31-272.0252	6	31-748.0292	6
10-1313.1209	10	31-273.0252	6	31-749.0292	6
10-1313.1249	10	31-274.0252	6	31-750.0292	6
10-1316.1179	10	31-281.022	6	31-801.002	5
10-1316.1209	10	31-281.0252	6	31-810.005	5
10-1319.1179	10	31-282.0252	6	31-901.0	7
10-1319.1199	10	31-283.0252	6	31-901.2	7
10-2J06.3142	10	31-284.0252	6	31-901.3	7
10-2J06.3144	10	31-421.036	6	31-901.4	7
10-2J06.3145	10	31-422.036	6	31-901.5	7
10-2J06.3146	10	31-423.036	6	31-901.6	7
10-2J06.3149	10	31-425.036	6	31-901.8	7
10-2J09.1062	10	31-426.036	6	31-901.9	7
10-2J09.1064	10	31-431.036	6	31-902.0	7
10-2J09.1065	10	31-432.036	6	31-902.8	7
10-2J09.1066	10	31-433.036	6	31-903.1	7
10-2J09.1069	10	31-435.036	6	31-903.2	7
10-2J12.1062	10	31-436.036	6	31-903.3	7
10-2J12.1064	10	31-451.036	6	31-903.4	7
10-2J12.1065	10	31-452.036	6	31-903.5	7
10-2J12.1066	10	31-453.036	6	31-903.6	7
10-2J12.1069	10	31-455.036	6	31-903.7	7
10-2J13.1062	10	31-456.036	6	31-904.2	7
10-2J13.1064	10	31-461.036	6	31-904.3	7
10-2J13.1065	10	31-462.036	6	31-904.4	7
10-2J13.1066	10	31-463.036	6	31-904.5	7
10-2J13.1069	10	31-465.036	6	31-904.6	7
10-2J19.1042	10	31-466.036	6	31-904.7	7
10-2J19.1044	10	31-471.036	6	31-905.2	7
10-2J19.1045	10	31-472.036	6	31-905.4	7
10-2J19.1046	10	31-473.036	6	31-905.5	7
10-2J19.1049	10	31-475.036	6	31-905.7	7
31-030.002	5	31-476.036	6	31-920	7
31-030.005	5	31-481.036	6	31-923	8
31-031.006	5	31-482.036	6	31-924.2	8
31-040.002	5	31-483.036	6	31-925	7
31-040.005	5	31-485.036	6	31-928	9
31-041.006	5	31-486.036	6	31-929	9
31-050.002	5	31-701.006	5	31-931.0	7
31-050.005	5	31-702.006	5	31-931.2	7
31-051.006	5	31-703.006	5	31-931.3	7

Index from Typ-Nr.

Typ-Nr.	Page	Typ-Nr.	Page	Typ-Nr.	Page
31-931.4	7				
31-931.5	7				
31-931.6	7				
31-931.8	7				
31-931.9	7				
31-933.1	7				
31-933.2	7				
31-933.3	7				
31-933.4	7				
31-933.5	7				
31-933.6	7				
31-933.7	7				
31-935.2	7				
31-935.4	7				
31-935.5	7				
31-935.7	7				
31-940	9				
31-941	9				
31-942	9				
31-945	9				
31-946	9				
31-951.0	7				
31-951.2	7				
31-951.3	7				
31-951.4	7				
31-951.5	7				
31-951.6	7				
31-951.8	7				
31-951.9	7				
31-952.0	7				
31-953.1	7				
31-953.2	7				
31-953.3	7				
31-953.4	7				
31-953.5	7				
31-953.6	7				
31-953.7	7				
31-954.2	7				
31-954.3	7				
31-954.4	7				
31-954.5	7				
31-954.6	7				
31-954.7	7				
31-955.2	7				
31-955.4	7				
31-955.5	7				
31-955.7	7				
61-9740.0	11				

	EAO AG
	Tannwaldstrasse 88 4601 Olten, Switzerland
E-mail	info@eao.com
Website	www.eao.com
	Austria
Phone	+49 201 85 87 0
Fax	+49 201 85 87 210
E-mail	sales.ede@eao.com
	Belgium
Phone	+32 3 777 82 36
Fax	+32 3 777 84 19
E-mail	sales.ebl@eao.com
	China
Phone	+852 27 86 91 41
Fax	+852 27 86 95 61
E-mail	sales.ehk@eao.com
	France
Phone	+33 1 64 43 37 37
Fax	+33 1 64 43 37 49
E-mail	sales.esa@eao.com
	Germany
Phone	+49 201 85 87 0
Fax	+49 201 85 87 210
E-mail	sales.ede@eao.com
	Italy
Phone	+39 035 481 0189
Fax	+39 035 481 3786
E-mail	sales.eit@eao.com
	Japan
Phone	+81 3 5444 5411
Fax	+81 3 5444 0345
E-mail	sales.esj@eao.com
	Netherlands
Phone	+31 78 653 17 00
Fax	+31 78 653 17 99
E-mail	sales.enl@eao.com
	Sweden
Phone	+46 8 683 86 60
Fax	+46 8 724 29 12
E-mail	sales.esw@eao.com
	Switzerland
Phone	+41 62 388 95 00
Fax	+41 62 388 95 55
E-mail	sales.ech@eao.com
	United Kingdom
Phone	+44 1444 236 000
Fax	+44 1444 236 641
E-mail	sales.euk@eao.com
	USA
Phone	+1 203 877 4577
Fax	+1 203 877 3694
E-mail	sales.eus@eao.com
	Other Countries
Phone	+41 62 286 92 10
Fax	+41 62 296 21 62
E-mail	info@eao.com



Компания «ЭлектроПласт» предлагает заключение долгосрочных отношений при поставках импортных электронных компонентов на взаимовыгодных условиях!

Наши преимущества:

- Оперативные поставки широкого спектра электронных компонентов отечественного и импортного производства напрямую от производителей и с крупнейших мировых складов;
- Поставка более 17-ти миллионов наименований электронных компонентов;
- Поставка сложных, дефицитных, либо снятых с производства позиций;
- Оперативные сроки поставки под заказ (от 5 рабочих дней);
- Экспресс доставка в любую точку России;
- Техническая поддержка проекта, помощь в подборе аналогов, поставка прототипов;
- Система менеджмента качества сертифицирована по Международному стандарту ISO 9001;
- Лицензия ФСБ на осуществление работ с использованием сведений, составляющих государственную тайну;
- Поставка специализированных компонентов (Xilinx, Altera, Analog Devices, Intersil, Interpoint, Microsemi, Aeroflex, Peregrine, Syfer, Eurofarad, Texas Instrument, Miteq, Cobham, E2V, MA-COM, Hittite, Mini-Circuits, General Dynamics и др.);

Помимо этого, одним из направлений компании «ЭлектроПласт» является направление «Источники питания». Мы предлагаем Вам помощь Конструкторского отдела:

- Подбор оптимального решения, техническое обоснование при выборе компонента;
- Подбор аналогов;
- Консультации по применению компонента;
- Поставка образцов и прототипов;
- Техническая поддержка проекта;
- Защита от снятия компонента с производства.



Как с нами связаться

Телефон: 8 (812) 309 58 32 (многоканальный)

Факс: 8 (812) 320-02-42

Электронная почта: org@eplast1.ru

Адрес: 198099, г. Санкт-Петербург, ул. Калинина, дом 2, корпус 4, литера А.