

## **SIOV metal oxide varistors**

Housed (ThermoFuse) varistors, AdvancedD series

**Series/Type:**        **ETFV20**  
**Date:**                April 2011

**Construction**

- Round varistor element, leaded
- Coating: epoxy resin, flame-retardant to UL 94 V-0
- Terminals: tinned copper wire, metal compound wire
- Housing: thermoplastic, flame-retardant to UL 94 V-0

**Features**

- Wide operating voltage range 130 ... 420 V<sub>RMS</sub>
- Self-protected under abnormal overvoltage conditions
- High-energy Advanced series E2

**Approvals**

- UL
- IEC
- VDE

**Applications**

- Air conditioner, refrigerator, TV, etc.
- Power meter, inverter, telecom equipment, etc.
- Transient voltage surge suppressors (TVSS)
- Solar inverter

**Delivery mode**

- Bulk (standard)

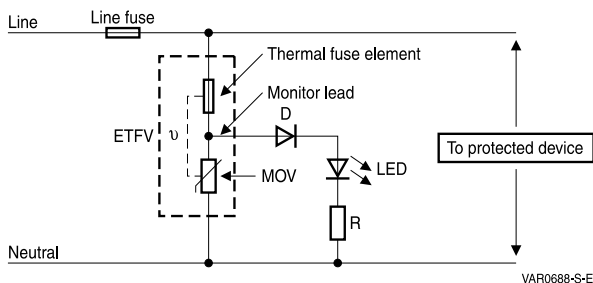
**Typical applications**

**General technical data**

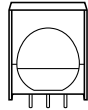
|                       |                |              |                   |
|-----------------------|----------------|--------------|-------------------|
| Climatic category     | to IEC 60068-1 | 40/85/56     |                   |
| Operating temperature | to IEC 61051   | -40 ... + 85 | °C                |
| Storage temperature   |                | -40 ... + 85 | °C                |
| Electric strength     | to IEC 61051   | ≥ 2.5        | kV <sub>RMS</sub> |
| Insulation resistance | to IEC 61051   | ≥ 100        | MΩ                |
| Response time         |                | < 25         | ns                |

**Electrical specifications and ordering codes**
**Maximum ratings ( $T_A = 85\text{ }^\circ\text{C}$ )**

| Ordering code   | Type<br>(untaped)<br>SIOV- | $V_{RMS}$ | $V_{DC}$ | $i_{max}$<br>(8/20 $\mu\text{s}$ ) | $W_{max}$<br>(2 ms) | $P_{max}$ |
|-----------------|----------------------------|-----------|----------|------------------------------------|---------------------|-----------|
|                 |                            | V         | V        | A                                  | J                   | W         |
| B72220T2131K101 | ETFV20K130E2               | 130       | 170      | 10000                              | 100                 | 1.0       |
| B72220T2141K101 | ETFV20K140E2               | 140       | 180      | 10000                              | 110                 | 1.0       |
| B72220T2151K101 | ETFV20K150E2               | 150       | 200      | 10000                              | 120                 | 1.0       |
| B72220T2171K101 | ETFV20K175E2               | 175       | 225      | 10000                              | 135                 | 1.0       |
| B72220T2211K101 | ETFV20K210E2               | 210       | 270      | 10000                              | 160                 | 1.0       |
| B72220T2231K101 | ETFV20K230E2               | 230       | 300      | 10000                              | 180                 | 1.0       |
| B72220T2251K101 | ETFV20K250E2               | 250       | 320      | 10000                              | 195                 | 1.0       |
| B72220T2271K101 | ETFV20K275E2               | 275       | 350      | 10000                              | 215                 | 1.0       |
| B72220T2301K101 | ETFV20K300E2               | 300       | 385      | 10000                              | 250                 | 1.0       |
| B72220T2321K101 | ETFV20K320E2               | 320       | 420      | 10000                              | 273                 | 1.0       |
| B72220T2351K101 | ETFV20K350E2               | 350       | 460      | 10000                              | 273                 | 1.0       |
| B72220T2381K101 | ETFV20K385E2               | 385       | 505      | 10000                              | 273                 | 1.0       |
| B72220T2421K101 | ETFV20K420E2               | 420       | 560      | 10000                              | 273                 | 1.0       |

**Characteristics ( $T_A = 25\text{ }^\circ\text{C}$ )**

| Ordering code   | Type<br>(untaped)<br>SIOV- | $V_V$<br>(1 mA) | $\Delta V_V$<br>(1 mA) | $V_{c,max}$<br>( $i_c$ ) | $i_c$ | $C_{typ}$<br>(1 kHz) |
|-----------------|----------------------------|-----------------|------------------------|--------------------------|-------|----------------------|
|                 |                            | V               | %                      | V                        | A     | pF                   |
| B72220T2131K101 | ETFV20K130E2               | 205             | $\pm 10$               | 340                      | 100   | 1340                 |
| B72220T2141K101 | ETFV20K140E2               | 220             | $\pm 10$               | 360                      | 100   | 1240                 |
| B72220T2151K101 | ETFV20K150E2               | 240             | $\pm 10$               | 395                      | 100   | 1160                 |
| B72220T2171K101 | ETFV20K175E2               | 270             | $\pm 10$               | 455                      | 100   | 1000                 |
| B72220T2211K101 | ETFV20K210E2               | 330             | $\pm 10$               | 545                      | 100   | 835                  |
| B72220T2231K101 | ETFV20K230E2               | 360             | $\pm 10$               | 595                      | 100   | 760                  |
| B72220T2251K101 | ETFV20K250E2               | 390             | $\pm 10$               | 650                      | 100   | 700                  |
| B72220T2271K101 | ETFV20K275E2               | 430             | $\pm 10$               | 710                      | 100   | 630                  |
| B72220T2301K101 | ETFV20K300E2               | 470             | $\pm 10$               | 775                      | 100   | 580                  |
| B72220T2321K101 | ETFV20K320E2               | 510             | $\pm 10$               | 840                      | 100   | 540                  |
| B72220T2351K101 | ETFV20K350E2               | 560             | $\pm 10$               | 910                      | 100   | 500                  |
| B72220T2381K101 | ETFV20K385E2               | 620             | $\pm 10$               | 1025                     | 100   | 450                  |
| B72220T2421K101 | ETFV20K420E2               | 680             | $\pm 10$               | 1120                     | 100   | 420                  |

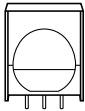

**Housed varistors**

**ETFV20**

**ThermoFuse varistors, ETFV20 series**

**Dimensional drawings**

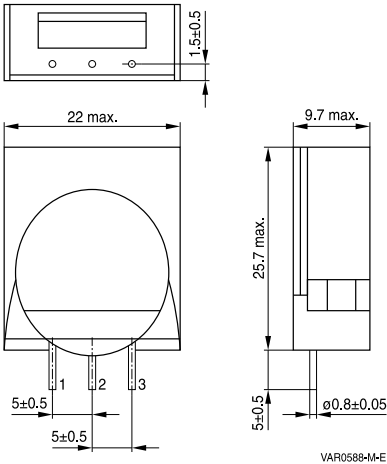

**Weight**

| Nominal diameter<br>mm | V <sub>RMS</sub><br>V | Weight<br>g |
|------------------------|-----------------------|-------------|
| 20                     | 130 ... 420           | 5.2 ... 8.4 |

**Lead configuration**

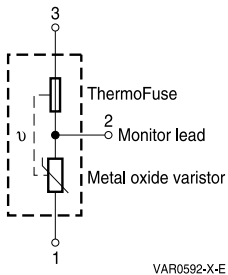

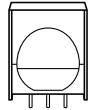

**Reliability data**

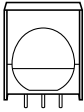
| Test                                    | Test methods/conditions  | Requirement  |
|---|--|--|
| Varistor voltage                        | The voltage between two terminals with the specified measuring current applied is called $V_V$ (1 mA <sub>DC</sub> @ 0.2 ... 2 s).   | To meet the specified value  |
| Clamping voltage                        | The maximum voltage between two terminals with the specified standard impulse current (8/20 $\mu$ s) applied.  | To meet the specified value  |
| Endurance at upper category temperature | 1000 h at UCT<br>After having continuously applied the maximum allowable AC voltage at UCT $\pm 2$ °C for 1000 h, the specimen shall be stored at room temperature and normal humidity for 1 to 2 h.<br>Thereafter, the change of $V_V$ shall be measured.   | $ \Delta V/V (1 \text{ mA})  \leq 10\%$  |
| Surge current derating, 8/20 $\mu$ s    | 10 surge currents (8/20 $\mu$ s), unipolar, interval 30 s, amplitude corresponding to derating curve for 10 impulses at 20 $\mu$ s   | $ \Delta V/V (1 \text{ mA})  \leq 10\%$<br>(measured in direction of surge current)<br>No visible damage |
| Surge current derating, 2 ms            | 10 surge currents (2 ms), unipolar, interval 120 s, amplitude corresponding to derating curve for 10 impulses at 2 ms  | $ \Delta V/V (1 \text{ mA})  \leq 10\%$<br>(measured in direction of surge current)<br>No visible damage |
| Electric strength                       | IEC 61051-1, test 4.9.2<br>Metal balls method, 2500 V <sub>RMS</sub> , 60 s<br>The varistor is placed in a container holding 1.6 $\pm$ 0.2 mm diameter metal balls such that only the terminations of the varistor are protruding.<br>The specified voltage shall be applied between both terminals of the specimen connected together and the electrode inserted between the metal balls. | No breakdown   |

**Housed varistors**
**ETFV20**
**ThermoFuse varistors, ETFV20 series**

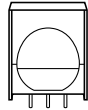
| Test                        | Test methods/conditions  | Requirement   |
|-----------------------------|--|---|
| Climatic sequence           | <p>The specimen shall be subjected to:</p> <p>a) dry heat at UCT, 16 h, IEC 60068-2-2, test Ba</p> <p>b) damp heat, 1st cycle:<br/>55 °C, 93% r. H., 24 h, IEC 60068-2-30, test Db</p> <p>c) cold, LCT, 2 h, IEC 60068-2-1, test Aa</p> <p>d) damp heat, additional 5 cycles:<br/>55 °C/25 °C, 93% r. H., 24 h/cycle, IEC 60068-2-30, test Db.</p> <p>Then the specimen shall be stored at room temperature and normal humidity for 1 to 2 h.</p> <p>Thereafter, the change of <math>V_V</math> shall be measured. Thereafter, insulation resistance <math>R_{ins}</math> shall be measured at <math>V = 500</math> V.</p> | $ \Delta V/V (1 \text{ mA})  \leq 10\%$<br>$R_{ins} \geq 100 \text{ M}\Omega$ |
| Rapid change of temperature | IEC 60068-2-14, test Na, LCT/UCT, dwell time 30 min, 5 cycles  | $ \Delta V/V (1 \text{ mA})  \leq 5\%$<br>No visible damage                   |
| Damp heat, steady state     | IEC 60068-2-78, test Ca<br><br>The specimen shall be subjected to $40 \pm 2$ °C, 90 to 95% r. H. for 56 days without load / with 10% of the maximum continuous DC operating voltage $V_{DC}$ . Then stored at room temperature and normal humidity for 1 to 2 h.<br><br>Thereafter, the change of $V_V$ shall be measured. Thereafter, insulation resistance $R_{ins}$ shall be measured at $V = 500$ V (insulated varistors only).  | $ \Delta V/V (1 \text{ mA})  \leq 10\%$<br>$R_{ins} \geq 100 \text{ M}\Omega$ |

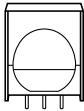

| Test                         | Test methods/conditions  | Requirement  |
|------------------------------|--|--|
| Solderability                | <p>IEC 60068-2-20, test Ta, method 1 with modified conditions for lead-free solder alloys: 245 °C, 3 s:</p> <p>After dipping the terminals to a depth of approximately 3 mm from the body in a soldering bath of 245 °C for 3 s, the terminals shall be visually examined.</p>   | <p>The inspection shall be carried out under adequate light with normal eyesight or with the assistance of a magnifier capable of giving a magnification of 4 to 10 times. The dipped surface shall be covered with a smooth and bright solder coating with no more than small amounts of scattered imperfections such as pinholes or un-wetted or de-wetted areas. These imperfections shall not be concentrated in one area.</p> |
| Resistance to soldering heat | <p>IEC 60068-2-20, test Tb, method 1A, 260 °C, 10 s:</p> <p>Each lead shall be dipped into a solder bath having a temperature of 260 ±5 °C to a point 2.0 to 2.5 mm from the body of the specimen, be held there for 10 ±1 s and then be stored at room temperature and normal humidity for 1 to 2 h.</p> <p>The change of <math>V_V</math> shall be measured and the specimen shall be visually examined.</p> | <p><math> \Delta V/V (1 \text{ mA})  \leq 5\%</math></p> <p>No visible damage</p>  |
| Tensile strength             | <p>IEC 60068-2-21, test Ua1</p> <p>After gradually applying the force specified below and keeping the unit fixed for 10 s, the terminal shall be visually examined for any damage.</p> <p>Force for wire diameter:</p> <p>0.6 mm = 10 N<br/>0.8 mm = 10 N<br/>1.0 mm = 20 N</p>  | <p><math> \Delta V/V (1 \text{ mA})  \leq 5\%</math></p> <p>No break of solder joint, no wire break</p>  |

**Housed varistors**
**ETFV20**
**ThermoFuse varistors, ETFV20 series**

| Test        | Test methods/conditions  | Requirement                           |
|-------------|--|---------------------------------------|
| Vibration   | IEC 60068-2-6, test Fc, method B4<br>Frequency range: 10 ... 55 Hz<br>Amplitude: 0.75 mm or 98 m/s <sup>2</sup><br>Duration: 6 h (3 · 2 h)<br>Pulse: sine wave<br>After repeatedly applying a single harmonic vibration according to the table above.<br>The change of V <sub>v</sub> shall be measured and the specimen shall be visually examined. | ΔV/V (1 mA)  ≤5%<br>No visible damage |
| Bump        | IEC 60068-2-29, test Eb<br>Pulse duration: 6 ms<br>Max. acceleration: 400 m/s <sup>2</sup><br>Number of bumps: 4000<br>Pulse: half sine  | ΔV/V (1 mA)  ≤5%<br>No visible damage |
| Fire hazard | IEC 60695-11-5 (needle flame test)<br>Severity: vertical 10 s  | 5 s max.                              |



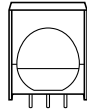

| Test                      | Test methods/conditions  | Requirement  |                 |                 |                |              |     |     |              |     |     |              |     |     |              |     |     |              |     |     |              |     |     |              |     |     |              |     |     |              |     |     |              |     |     |              |     |     |              |     |     |              |     |     |
|---------------------------|--|--|-----------------|-----------------|----------------|--------------|-----|-----|--------------|-----|-----|--------------|-----|-----|--------------|-----|-----|--------------|-----|-----|--------------|-----|-----|--------------|-----|-----|--------------|-----|-----|--------------|-----|-----|--------------|-----|-----|--------------|-----|-----|--------------|-----|-----|--------------|-----|-----|
| Abnormal overvoltage test | The device is designed to meet the limited current abnormal overvoltage condition, outlined in section 39.4 of UL 1449, 3 <sup>rd</sup> edition.<br>Detailed test voltage applied onto the device for different types as in the following table:   | Any of these phenomena shall not be observed, or this specimen will be judged as failed part: <ol style="list-style-type: none"> <li>1. Emission of flame, molten metal, glowing or flaming particles through any openings (pre-existed or created as a result of the test) in the product.</li> <li>2. Charring, glowing, or flaming of the supporting surface, tissue paper, or cheesecloth.</li> <li>3. Ignition of the enclosure.</li> <li>4. Creation of any openings in the enclosure that result in accessibility of live parts, when evaluated in accordance with accessibility of live parts test in section 58.2 of UL1449, 3<sup>rd</sup> edition.</li> </ol> |                 |                 |                |              |     |     |              |     |     |              |     |     |              |     |     |              |     |     |              |     |     |              |     |     |              |     |     |              |     |     |              |     |     |              |     |     |              |     |     |              |     |     |
|                           | <table border="1"> <thead> <tr> <th>Type</th> <th>Device rating V</th> <th>Test voltage V</th> </tr> </thead> <tbody> <tr> <td>ETFV20K130E2</td> <td>130</td> <td>260</td> </tr> <tr> <td>ETFV20K140E2</td> <td>140</td> <td>280</td> </tr> <tr> <td>ETFV20K150E2</td> <td>150</td> <td>300</td> </tr> <tr> <td>ETFV20K175E2</td> <td>175</td> <td>350</td> </tr> <tr> <td>ETFV20K210E2</td> <td>210</td> <td>420</td> </tr> <tr> <td>ETFV20K230E2</td> <td>230</td> <td>415</td> </tr> <tr> <td>ETFV20K250E2</td> <td>250</td> <td>500</td> </tr> <tr> <td>ETFV20K275E2</td> <td>275</td> <td>480</td> </tr> <tr> <td>ETFV20K300E2</td> <td>300</td> <td>600</td> </tr> <tr> <td>ETFV20K320E2</td> <td>320</td> <td>600</td> </tr> <tr> <td>ETFV20K350E2</td> <td>350</td> <td>600</td> </tr> <tr> <td>ETFV20K385E2</td> <td>385</td> <td>600</td> </tr> <tr> <td>ETFV20K420E2</td> <td>420</td> <td>600</td> </tr> </tbody> </table> |  | Type            | Device rating V | Test voltage V | ETFV20K130E2 | 130 | 260 | ETFV20K140E2 | 140 | 280 | ETFV20K150E2 | 150 | 300 | ETFV20K175E2 | 175 | 350 | ETFV20K210E2 | 210 | 420 | ETFV20K230E2 | 230 | 415 | ETFV20K250E2 | 250 | 500 | ETFV20K275E2 | 275 | 480 | ETFV20K300E2 | 300 | 600 | ETFV20K320E2 | 320 | 600 | ETFV20K350E2 | 350 | 600 | ETFV20K385E2 | 385 | 600 | ETFV20K420E2 | 420 | 600 |
|                           | Type   |  | Device rating V | Test voltage V  |                |              |     |     |              |     |     |              |     |     |              |     |     |              |     |     |              |     |     |              |     |     |              |     |     |              |     |     |              |     |     |              |     |     |              |     |     |              |     |     |
|                           | ETFV20K130E2   |  | 130             | 260             |                |              |     |     |              |     |     |              |     |     |              |     |     |              |     |     |              |     |     |              |     |     |              |     |     |              |     |     |              |     |     |              |     |     |              |     |     |              |     |     |
|                           | ETFV20K140E2   |  | 140             | 280             |                |              |     |     |              |     |     |              |     |     |              |     |     |              |     |     |              |     |     |              |     |     |              |     |     |              |     |     |              |     |     |              |     |     |              |     |     |              |     |     |
|                           | ETFV20K150E2   |  | 150             | 300             |                |              |     |     |              |     |     |              |     |     |              |     |     |              |     |     |              |     |     |              |     |     |              |     |     |              |     |     |              |     |     |              |     |     |              |     |     |              |     |     |
|                           | ETFV20K175E2   |  | 175             | 350             |                |              |     |     |              |     |     |              |     |     |              |     |     |              |     |     |              |     |     |              |     |     |              |     |     |              |     |     |              |     |     |              |     |     |              |     |     |              |     |     |
|                           | ETFV20K210E2   |  | 210             | 420             |                |              |     |     |              |     |     |              |     |     |              |     |     |              |     |     |              |     |     |              |     |     |              |     |     |              |     |     |              |     |     |              |     |     |              |     |     |              |     |     |
|                           | ETFV20K230E2   |  | 230             | 415             |                |              |     |     |              |     |     |              |     |     |              |     |     |              |     |     |              |     |     |              |     |     |              |     |     |              |     |     |              |     |     |              |     |     |              |     |     |              |     |     |
|                           | ETFV20K250E2   |  | 250             | 500             |                |              |     |     |              |     |     |              |     |     |              |     |     |              |     |     |              |     |     |              |     |     |              |     |     |              |     |     |              |     |     |              |     |     |              |     |     |              |     |     |
|                           | ETFV20K275E2   |  | 275             | 480             |                |              |     |     |              |     |     |              |     |     |              |     |     |              |     |     |              |     |     |              |     |     |              |     |     |              |     |     |              |     |     |              |     |     |              |     |     |              |     |     |
|                           | ETFV20K300E2   |  | 300             | 600             |                |              |     |     |              |     |     |              |     |     |              |     |     |              |     |     |              |     |     |              |     |     |              |     |     |              |     |     |              |     |     |              |     |     |              |     |     |              |     |     |
|                           | ETFV20K320E2   |  | 320             | 600             |                |              |     |     |              |     |     |              |     |     |              |     |     |              |     |     |              |     |     |              |     |     |              |     |     |              |     |     |              |     |     |              |     |     |              |     |     |              |     |     |
|                           | ETFV20K350E2   |  | 350             | 600             |                |              |     |     |              |     |     |              |     |     |              |     |     |              |     |     |              |     |     |              |     |     |              |     |     |              |     |     |              |     |     |              |     |     |              |     |     |              |     |     |
| ETFV20K385E2              | 385  | 600  |                 |                 |                |              |     |     |              |     |     |              |     |     |              |     |     |              |     |     |              |     |     |              |     |     |              |     |     |              |     |     |              |     |     |              |     |     |              |     |     |              |     |     |
| ETFV20K420E2              | 420  | 600  |                 |                 |                |              |     |     |              |     |     |              |     |     |              |     |     |              |     |     |              |     |     |              |     |     |              |     |     |              |     |     |              |     |     |              |     |     |              |     |     |              |     |     |

**Note:**

UCT = Upper category temperature

LCT = Lower category temperature

 R<sub>ins</sub> = Insulation resistance

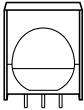

**v/i characteristics**

$v = f(i)$  for explanation of the characteristics refer to "General technical information", chapter 1.6.3  
 A = Leakage current, B = Protection level } for worst-case varistor tolerances

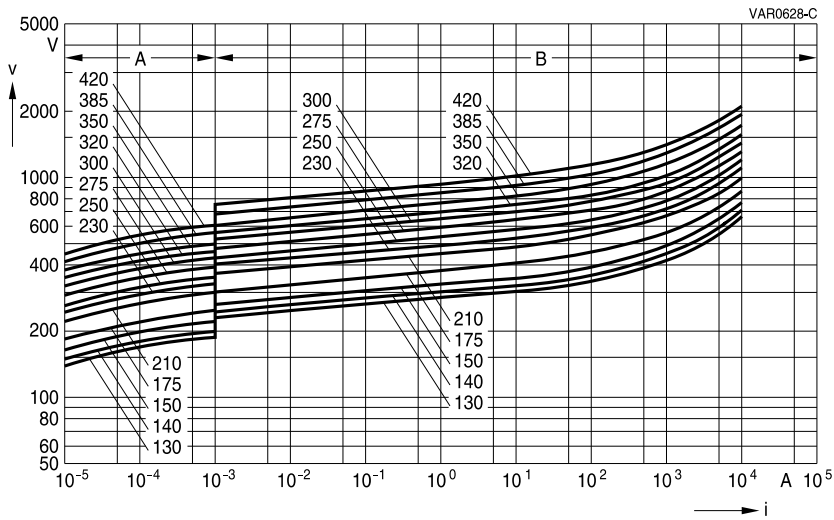

**SIOV-ETFV20 ... E2**

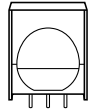

**Derating curves**

Maximum surge current  $i_{max} = f(t_r, \text{pulse train})$

For explanation of the derating curves refer to "General technical information", section 1.8.1

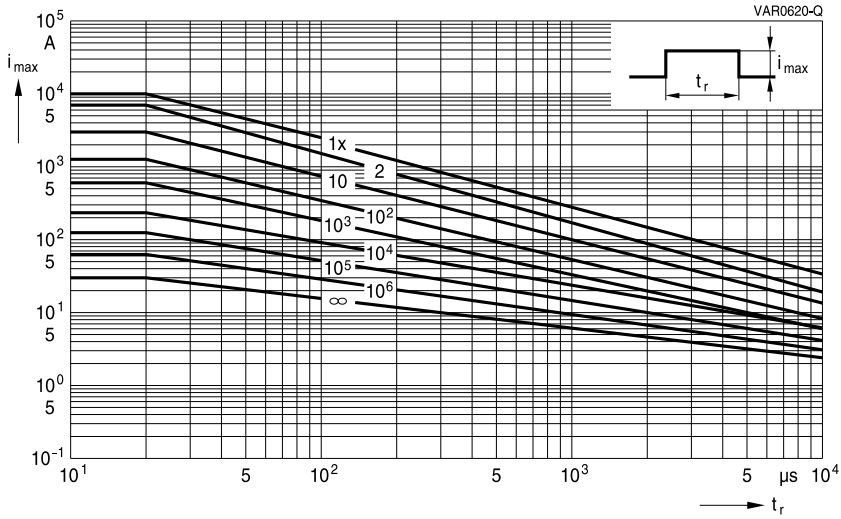

SIOV-ETFV20 ... E2

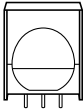

## Cautions and warnings

### General

1. EPCOS metal oxide varistors are designed for specific applications and should not be used for purposes not identified in our specifications, application notes and data books unless otherwise agreed with EPCOS during the design-in-phase.
2. Ensure suitability of SIOVs through reliability testing during the design-in phase. SIOVs should be evaluated taking into consideration worst-case conditions.
3. For applications of SIOVs in line-to-ground circuits based on various international and local standards there are restrictions existing or additional safety measures required.

### Storage

1. Store SIOVs only in original packaging. Do not open the package before storage.
2. Storage conditions in original packaging:  
 Storage temperature:  $-25\text{ }^{\circ}\text{C} \dots +45\text{ }^{\circ}\text{C}$ ,  
 Relative humidity:  $<75\%$  annual average,  
 $<95\%$  on maximum 30 days a year.  
 Dew precipitation: is to be avoided.
3. Avoid contamination of an SIOV's during storage, handling and processing.
4. Avoid storage of SIOVs in harmful environments that can affect the function during long-term operation (examples given under operation precautions).
5. The SIOV type series should be soldered within the time specified:
 

|                           |            |
|---------------------------|------------|
| SIOV-S, -Q, -LS, -B, -SFS | 24 months  |
| ETFV                      | 12 months. |

### Handling

1. SIOVs must not be dropped.
2. Components must not be touched with bare hands. Gloves are recommended.
3. Avoid contamination of the surface of SIOV electrodes during handling, be careful of the sharp edge of SIOV electrodes.

### Soldering (where applicable)

1. Use rosin-type flux or non-activated flux.
2. Insufficient preheating may cause ceramic cracks.
3. Rapid cooling by dipping in solvent is not recommended.
4. Complete removal of flux is recommended.

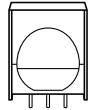

### Mounting

1. Potting, sealing or adhesive compounds can produce chemical reactions in the SIOV ceramic that will degrade the component's electrical characteristics.
2. Overloading SIOVs may result in ruptured packages and expulsion of hot materials. For this reason SIOVs should be physically shielded from adjacent components.

### Operation

1. Use SIOVs only within the specified temperature operating range.
2. Use SIOVs only within the specified voltage and current ranges.
3. Environmental conditions must not harm SIOVs. Use SIOVs only in normal atmospheric conditions. Avoid use in deoxidizing gases (chlorine gas, hydrogen sulfide gas, ammonia gas, sulfuric acid gas etc), corrosive agents, humid or salty conditions. Contact with any liquids and solvents should be prevented.

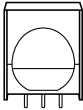
**Symbols and terms**

| Symbol             | Term   |
|--------------------|--|
| C                  | Capacitance  |
| $C_{typ}$          | Typical capacitance  |
| i                  | Current  |
| $i_c$              | Current at which $V_{c, max}$ is measured                                |
| $I_{leak}$         | Leakage current  |
| $i_{max}$          | Maximum surge current (also termed peak current)                         |
| $I_{max}$          | Maximum discharge current to IEC 61643-1                                 |
| $I_{nom}$          | Nominal discharge current to IEC 61643-1                                 |
| LCT                | Lower category temperature   |
| $L_{typ}$          | Typical inductance   |
| $P_{max}$          | Maximum average power dissipation  |
| $R_{ins}$          | Insulation resistance  |
| $R_{min}$          | Minimum resistance   |
| $T_A$              | Ambient temperature  |
| $t_r$              | Duration of equivalent rectangular wave                                  |
| UCT                | Upper category temperature   |
| v                  | Voltage  |
| $V_{clamp}$        | Clamping voltage   |
| $V_{c, max}$       | Maximum clamping voltage at specified current $i_c$                      |
| $V_{DC}$           | DC operating voltage   |
| $V_{jump}$         | Maximum jump start voltage   |
| $V_{max}$          | Maximum voltage  |
| $V_{op}$           | Operating voltage  |
| $V_{RMS}$          | AC operating voltage, root-mean-square value                             |
| $V_{RMS, op, max}$ | Root-mean-square value of max. DC operating voltage incl. ripple current |
| $V_{surge}$        | Super imposed surge voltage  |
| $V_V$              | Varistor voltage   |
| $\Delta V_V$       | Tolerance of varistor voltage  |
| $W_{LD}$           | Maximum load dump  |
| $W_{max}$          | Maximum energy absorption  |
| $e$                | Lead spacing   |

All dimensions are given in mm.

The commas used in numerical values denote decimal points.

## Important notes

The following applies to all products named in this publication:

1. Some parts of this publication contain **statements about the suitability of our products for certain areas of application**. These statements are based on our knowledge of typical requirements that are often placed on our products in the areas of application concerned. We nevertheless expressly point out **that such statements cannot be regarded as binding statements about the suitability of our products for a particular customer application**. As a rule, EPCOS is either unfamiliar with individual customer applications or less familiar with them than the customers themselves. For these reasons, it is always ultimately incumbent on the customer to check and decide whether an EPCOS product with the properties described in the product specification is suitable for use in a particular customer application.
2. We also point out that **in individual cases, a malfunction of electronic components or failure before the end of their usual service life cannot be completely ruled out in the current state of the art, even if they are operated as specified**. In customer applications requiring a very high level of operational safety and especially in customer applications in which the malfunction or failure of an electronic component could endanger human life or health (e.g. in accident prevention or lifesaving systems), it must therefore be ensured by means of suitable design of the customer application or other action taken by the customer (e.g. installation of protective circuitry or redundancy) that no injury or damage is sustained by third parties in the event of malfunction or failure of an electronic component.
3. **The warnings, cautions and product-specific notes must be observed.**
4. In order to satisfy certain technical requirements, **some of the products described in this publication may contain substances subject to restrictions in certain jurisdictions (e.g. because they are classed as hazardous)**. Useful information on this will be found in our Material Data Sheets on the Internet ([www.epcos.com/material](http://www.epcos.com/material)). Should you have any more detailed questions, please contact our sales offices.
5. We constantly strive to improve our products. Consequently, **the products described in this publication may change from time to time**. The same is true of the corresponding product specifications. Please check therefore to what extent product descriptions and specifications contained in this publication are still applicable before or when you place an order. We also **reserve the right to discontinue production and delivery of products**. Consequently, we cannot guarantee that all products named in this publication will always be available. The aforementioned does not apply in the case of individual agreements deviating from the foregoing for customer-specific products.
6. Unless otherwise agreed in individual contracts, **all orders are subject to the current version of the "General Terms of Delivery for Products and Services in the Electrical Industry" published by the German Electrical and Electronics Industry Association (ZVEI)**.
7. The trade names EPCOS, BAOKE, Alu-X, CeraDiode, CSMP, CSSP, CTVS, DeltaCap, DigiSiMic, DSSP, FormFit, MiniBlue, MiniCell, MKK, MKD, MLSC, MotorCap, PCC, PhaseCap, PhaseCube, PhaseMod, PhiCap, SIFERRIT, SIFI, SIKOREL, SilverCap, SIMDAD, SiMic, SIMID, SineFormer, SIOV, SIP5D, SIP5K, ThermoFuse, WindCap are **trademarks registered or pending** in Europe and in other countries. Further information will be found on the Internet at [www.epcos.com/trademarks](http://www.epcos.com/trademarks).



Компания «ЭлектроПласт» предлагает заключение долгосрочных отношений при поставках импортных электронных компонентов на взаимовыгодных условиях!

Наши преимущества:

- Оперативные поставки широкого спектра электронных компонентов отечественного и импортного производства напрямую от производителей и с крупнейших мировых складов;
- Поставка более 17-ти миллионов наименований электронных компонентов;
- Поставка сложных, дефицитных, либо снятых с производства позиций;
- Оперативные сроки поставки под заказ (от 5 рабочих дней);
- Экспресс доставка в любую точку России;
- Техническая поддержка проекта, помощь в подборе аналогов, поставка прототипов;
- Система менеджмента качества сертифицирована по Международному стандарту ISO 9001;
- Лицензия ФСБ на осуществление работ с использованием сведений, составляющих государственную тайну;
- Поставка специализированных компонентов (Xilinx, Altera, Analog Devices, Intersil, Interpoint, Microsemi, Aeroflex, Peregrine, Syfer, Eurofarad, Texas Instrument, Miteq, Cobham, E2V, MA-COM, Hittite, Mini-Circuits, General Dynamics и др.);

Помимо этого, одним из направлений компании «ЭлектроПласт» является направление «Источники питания». Мы предлагаем Вам помощь Конструкторского отдела:

- Подбор оптимального решения, техническое обоснование при выборе компонента;
- Подбор аналогов;
- Консультации по применению компонента;
- Поставка образцов и прототипов;
- Техническая поддержка проекта;
- Защита от снятия компонента с производства.



#### Как с нами связаться

**Телефон:** 8 (812) 309 58 32 (многоканальный)

**Факс:** 8 (812) 320-02-42

**Электронная почта:** [org@eplast1.ru](mailto:org@eplast1.ru)

**Адрес:** 198099, г. Санкт-Петербург, ул. Калинина, дом 2, корпус 4, литера А.