



Intel® NUC Products NUC7CJY/NUC7PJY Technical Product Specification

Regulatory Models: NUC7JY (Kit/Mini PC)

NUC7JYB (Board)

February 2019

Order Number: J96982-003

The Intel NUC Products NUC7CJY/NUC7PJY may contain design defects or errors known as errata that may cause the product to deviate from published specifications. Current characterized errata are documented in the Intel NUC Products NUC7CJY/NUC7PJY Specification Update.

Revision History

Revision	Revision History	Date
001	First release of Intel NUC Products NUC7CJY/NUC7PJY Technical Product Specification	January 2018
002	Spec Change	February 2018
003	Spec Change	February 2019

Disclaimer

This product specification applies to only the standard Intel® NUC Boards, Kits and Mini PCs with BIOS identifier JYGLKCPX.86A.

INFORMATION IN THIS DOCUMENT IS PROVIDED IN CONNECTION WITH INTEL® PRODUCTS. NO LICENSE, EXPRESS OR IMPLIED, BY ESTOPPEL OR OTHERWISE, TO ANY INTELLECTUAL PROPERTY RIGHTS IS GRANTED BY THIS DOCUMENT. EXCEPT AS PROVIDED IN INTEL'S TERMS AND CONDITIONS OF SALE FOR SUCH PRODUCTS, INTEL ASSUMES NO LIABILITY WHATSOEVER, AND INTEL DISCLAIMS ANY EXPRESS OR IMPLIED WARRANTY, RELATING TO SALE AND/OR USE OF INTEL PRODUCTS INCLUDING LIABILITY OR WARRANTIES RELATING TO FITNESS FOR A PARTICULAR PURPOSE, MERCHANTABILITY, OR INFRINGEMENT OF ANY PATENT, COPYRIGHT OR OTHER INTELLECTUAL PROPERTY RIGHT. UNLESS OTHERWISE AGREED IN WRITING BY INTEL, THE INTEL PRODUCTS ARE NOT DESIGNED NOR INTENDED FOR ANY APPLICATION IN WHICH THE FAILURE OF THE INTEL PRODUCT COULD CREATE A SITUATION WHERE PERSONAL INJURY OR DEATH MAY OCCUR.

All Intel® NUC Boards are evaluated as Information Technology Equipment (I.T.E.) for use in personal computers (PC) for installation in homes, offices, schools, computer rooms, and similar locations. The suitability of this product for other PC or embedded non-PC applications or other environments, such as medical, industrial, alarm systems, test equipment, etc. may not be supported without further evaluation by Intel.

Intel Corporation may have patents or pending patent applications, trademarks, copyrights, or other intellectual property rights that relate to the presented subject matter. The furnishing of documents and other materials and information does not provide any license, express or implied, by estoppel or otherwise, to any such patents, trademarks, copyrights, or other intellectual property rights.

Intel may make changes to specifications and product descriptions at any time, without notice.

Designers must not rely on the absence or characteristics of any features or instructions marked "reserved" or "undefined." Intel reserves these for future definition and shall have no responsibility whatsoever for conflicts or incompatibilities arising from future changes to them.

Intel processor numbers are not a measure of performance. Processor numbers differentiate features within each processor family, not across different processor families: Go to: [Learn About Intel® Processor Numbers](#)

Intel NUC Boards and kits may contain design defects or errors known as errata, which may cause the product to deviate from published specifications. Current characterized errata are available on request.

Contact your local Intel sales office or your distributor to obtain the latest specifications before placing your product order.

Intel, Pentium and Celeron are trademarks of Intel Corporation in the U.S. and/or other countries.

* Other names and brands may be claimed as the property of others.

Copyright © 2019 Intel Corporation. All rights reserved.

Note: For this Technical Products Specification, the use of **Intel NUC Products NUC7CJY/NUC7PJY** refers to **Intel NUC Kit NUC7CJYH, Intel NUC Kit NUC7PJYH, Intel NUC Mini PC NUC7CJYS, and Intel NUC Boards NUC7CJYB and NUC7PJYB.**

Board Identification Information

Basic Intel® NUC Board Identification Information

Intel NUC Board	AA Revision	BIOS Revision	Notes
NUC7CJYB	J67967-400	JYGLKCPX.86A.0027	1, 2
NUC7CJYB	J67970-400	JYGLKCPX.86A.0027	1, 2, 4
NUC7PJYB	J67969-400	JYGLKCPX.86A.0027	1, 3

Notes:

- The AA number is found on a small label on the SO-DIMM memory connector.
- Intel® Celeron® processor J4005 used on this AA revision consists of the following component:

Device	Stepping	S-Spec Number(s)
Intel Celeron processor	B0	SR3S5

- Intel® Pentium® Silver processor J5005 used on this AA revision consists of the following component:

Device	Stepping	S-Spec Number(s)
Intel Pentium Silver processor	B0	SR3S3

- Contains a 32GB embedded MultiMediaCard (e-MMC) device consisting of one of the following components:

Device	Model	Version
SanDisk	SDINADF4-32G-H	5.1
Kingston	EMMC32G-M525-A53	5.1
Kingston	EMMC32G-TA28-A01	5.1

Product Identification Information

Intel® NUC Products NUC7{x}JY{y}† Identification Information

Product Name	Intel NUC Kit SA #	Intel® NUC Board AA #	Differentiating Features
NUC7CJYH	J67971-400	J67967-400	Kit with power adapter, no memory, no eMMC, no OS
NUC7PJYH	J67992-400	J67969-400	Kit with power adapter, no memory, no eMMC, no OS
NUC7CJYS	J67993-400 J67994-400	J67970-400	Mini PC with power adapter, preinstalled with 4GB 2400MHz DDR4 SO-DIMM, 32GB e-MMC with Microsoft* Windows* 10 Home

Note:

†where {x} = "C" for "Celeron", "P" for "Pentium", and {y} = "H" for "kit" and "S" = "system"

Specification Changes or Clarifications

The table below indicates the Specification Changes or Specification Clarifications that apply to the Intel NUC Products NUC7CJY/NUC7PJY.

Specification Changes or Clarifications

Date	Type of Change	Description of Changes or Clarifications
February 2018	Specification Change	<ul style="list-style-type: none">• Correct Pentium core count• Correct graphics designator
February 2019	Specification Change	Added section 2.4.2 - Weights

Errata

Current characterized errata, if any, are documented in a separate Specification Update. See <http://www.intel.com/content/www/us/en/nuc/overview.html> for the latest documentation.

Preface

This Technical Product Specification (TPS) specifies the layout, components, connectors, power and environmental requirements, and the BIOS for Intel® NUC Products NUC7CJY/NUC7PJY. The Intel® NUC Kits NUC7CJYH/NUC7PJYH are without memory and operating system, and the Intel® NUC Mini PC NUC7CJYS is with pre-installed SO-DIMM memory and operating system.

Intended Audience

The TPS is intended to provide detailed technical information about Intel NUC Products NUC7CJY/NUC7PJY and their components to the vendors, system integrators, and other engineers and technicians who need this level of information. It is specifically *not* intended for general audiences.

What This Document Contains

Chapter	Description
1	A description of the hardware used in Intel NUC Products NUC7CJY/NUC7PJY
2	A map of the resources of the Intel NUC Board
3	The features supported by the BIOS Setup program
4	A description of the front panel blink codes and BIOS error messages
5	The features of the Intel NUC Kits and Mini PCs

Typographical Conventions

This section contains information about the conventions used in this specification. Not all of these symbols and abbreviations appear in all specifications of this type.

Notes, Cautions, and Warnings



NOTE

Notes call attention to important information.



CAUTION

Cautions are included to help you avoid damaging hardware or losing data.

Other Common Notation

#	Used after a signal name to identify an active-low signal (such as USBP0#)
bpp	Bits per pixel
GB	Gigabyte (1,073,741,824 bytes)
GBps	Gigabytes per second
Gbps	Gigabits per second
KB	Kilobyte (1024 bytes)
Kb	Kilobit (1024 bits)
kbps	1000 bits per second
MB	Megabyte (1,048,576 bytes)
MBps	Megabytes per second
Mb	Megabit (1,048,576 bits)
Mbps	Megabits per second
TDP	Thermal Design Power
xxh	An address or data value ending with a lowercase h indicates a hexadecimal value.
x.x V	Volts. Voltages are DC unless otherwise specified.
*	This symbol is used to indicate third-party brands and names that are the property of their respective owners.
[]	Specific keyboard key callouts are enclosed in brackets, e.g., [ESC]

Contents

Revision History	ii
Board Identification Information.....	iii
Product Identification Information.....	iii
Errata.....	iv
Preface	v
Intended Audience.....	v
What This Document Contains	v
Typographical Conventions	v
Contents	vii
1 Product Description	11
1.1 Overview	11
1.1.1 Feature Summary	11
1.1.2 Board Layout (Top)	13
1.1.3 Board Layout (Bottom)	14
1.1.4 Block Diagram	16
1.2 Online Support.....	17
1.3 Processor.....	17
1.4 System Memory	18
1.5 Processor Graphics Subsystem.....	20
1.5.1 Intel® Ultra-High Definition (Intel® UHD) Graphics	20
1.5.2 High Definition Multimedia Interface* (HDMI*)	20
1.6 USB.....	21
1.7 SATA Interface.....	21
1.7.1 AHCI Mode.....	21
1.8 Embedded MultiMediaCard (e-MMC) - <i>optional</i>	21
1.9 Real-Time Clock Subsystem.....	22
1.10 Audio Subsystem	23
1.10.1 Digital Microphone Array.....	24
1.10.2 Mini-TOSLINK Interface	24
1.10.3 Audio Subsystem Software	24
1.11 LAN Subsystem.....	25
1.11.1 Realtek* 8111HN Gigabit Ethernet Controller	25
1.11.2 LAN Subsystem Software.....	25
1.11.3 RJ-45 LAN Connector with Integrated LEDs	26
1.11.4 Wireless Network Module	26
1.12 Hardware Management Subsystem	27
1.12.1 Hardware Monitoring	27

1.12.2	Fan Monitoring.....	27
1.12.3	Thermal Solution.....	28
1.13	Operating System Support.....	28
1.14	Power Management.....	29
1.14.1	ACPI.....	29
1.14.2	Hardware Support.....	31
1.14.3	HDMI Consumer Electronics Control (CEC).....	33
1.15	Intel Platform Security Technologies.....	35
1.15.1	Intel® Virtualization Technology.....	35
1.15.2	Intel® Platform Trust Technology.....	35
2	Technical Reference.....	37
2.1	Memory Resources.....	37
2.1.1	Addressable Memory.....	37
2.2	Connectors and Headers.....	37
2.2.1	Front Panel Connectors.....	38
2.2.2	Back Panel Connectors.....	38
2.2.3	Headers and Connectors (Top).....	39
2.2.4	Connectors and Headers (Bottom).....	40
2.3	BIOS Security Jumper.....	48
2.4	Mechanical Considerations.....	50
2.4.1	Form Factor.....	50
2.4.2	Weights.....	51
2.5	Electrical Considerations.....	51
2.5.1	Power Supply Considerations.....	51
2.5.2	Fan Header Current Capability.....	51
2.6	Thermal Considerations.....	52
2.7	Reliability.....	55
2.8	Environmental.....	55
3	Overview of BIOS Features.....	57
3.1	Introduction.....	57
3.2	BIOS Flash Memory Organization.....	57
3.3	System Management BIOS (SMBIOS).....	57
3.4	Legacy USB Support.....	58
3.5	BIOS Updates.....	58
3.5.1	Language Support.....	58
3.6	BIOS Recovery.....	58
3.7	Boot Options.....	59
3.7.1	Network Boot.....	59
3.7.2	Booting Without Attached Devices.....	59
3.7.3	Changing the Default Boot Device During POST.....	59
3.7.4	Power Button Menu.....	60
3.8	Hard Disk Drive Password Security Feature.....	61

3.9	BIOS Security Features	62
4	Error Messages and Blink Codes	63
4.1	Front-panel Power LED Blink Codes	63
4.2	BIOS Error Messages.....	63
5	Intel NUC Kit Features	64
5.1	Chassis Front Panel Features	64
5.2	Chassis Rear Panel Features.....	65

Figures

Figure 1.	Major Board Components (Top)	13
Figure 2.	Major Board Components (Bottom)	14
Figure 3.	Block Diagram.....	16
Figure 4.	Memory Channel and SO-DIMM Configuration.....	19
Figure 5.	4-Pin 3.5 mm (1/8 inch) Audio Jack Pin Out	23
Figure 6.	Mini-TOSLINK Adaptor (not included)	24
Figure 7.	LAN Connector LED Locations.....	26
Figure 8.	Thermal Solution and Fan Header.....	28
Figure 9.	Location of the Standby Power LED	33
Figure 10.	CEC Connector.....	34
Figure 11.	Front Panel Connectors, Controls and Indicators	38
Figure 12.	Back Panel Connectors	38
Figure 13.	Headers and Connectors (Top).....	39
Figure 14.	Connectors and Headers (Bottom)	40
Figure 15.	Connection Diagram for Front Panel Header (2.0 mm Pitch)	45
Figure 16.	Location of the CIR Sensor	47
Figure 17.	Location of the BIOS Security Jumper	48
Figure 18.	Board Dimensions.....	50
Figure 19.	Board Height Dimensions	51
Figure 20.	Localized High Temperature Zones	53
Figure 21.	Intel NUC Products NUC7CJYH/NUC7PJYH/NUC7CJYS Features – Front	64
Figure 22.	Intel NUC Products NUC7CJYH/NUC7PJYH/NUC7CJYS Features – Rear	65

Tables

Table 1.	Feature Summary	11
Table 2.	Components Shown in Figure 1	13
Table 3.	Components Shown in Figure 2.....	15
Table 4.	Supported Memory Configurations.....	18
Table 5.	Unsupported Memory Configurations.....	18
Table 6.	LAN Connector LED States.....	26
Table 7.	Effects of Pressing the Power Switch.....	29
Table 8.	Power States and Targeted System Power	30
Table 9.	Wake-up Devices and Events.....	31

Table 10. HDMI 1 CEC expected behavior	34
Table 11. Headers and Connectors Shown in Figure 13	39
Table 12. LPC Debug Header (2.0 mm Pitch – not stuffed).....	39
Table 13. Connectors and Headers Shown in Figure 14	41
Table 14. SATA Power Header (1.25 mm Pitch).....	41
Table 15. Single-Port Internal USB 2.0 Headers (1.25 mm Pitch).....	42
Table 16. Digital Microphone (DMICS) Array Connector (1.25 mm Pitch).....	42
Table 17. RGB LED Connector (1.25 mm Pitch)	42
Table 18. Consumer Electronics Control (CEC) Connector (1.25 mm Pitch)	43
Table 19. SDXC Card Reader Connector	43
Table 20. Auxiliary Power Connector	44
Table 21. Front Panel Header (2.0 mm Pitch).....	45
Table 22. States for a One-Color Power LED	46
Table 23. States for a Dual-Color Power LED	46
Table 24. BIOS Security Jumper Settings.....	49
Table 25. Select Weights	51
Table 26. Fan Header Current Capability.....	51
Table 27. Thermal Considerations for Components.....	54
Table 28. Tcontrol Values for Components	54
Table 29. Environmental Specifications.....	55
Table 30. Acceptable Drives/Media Types for BIOS Recovery	58
Table 31. Boot Device Menu Options.....	60
Table 32. Master Key and User Hard Drive Password Functions.....	61
Table 33. Supervisor and User Password Functions.....	62
Table 34. Front-panel Power LED Blink Codes	63
Table 35. BIOS Error Messages.....	63
Table 36. Components Shown in Figure 21	64
Table 37. Components Shown in Figure 22	65

1 Product Description

1.1 Overview

1.1.1 Feature Summary

Table 1 summarizes the major features of the product.

Table 1. Feature Summary

Board Form Factor	4.0 inches by 4.0 inches (101.60 millimeters by 101.60 millimeters)
Processor	Intel NUC Kit NUC7CJYH / Intel NUC Mini PC NUC7CJYS Soldered-down dual-core Intel® Celeron® processor J4005 <ul style="list-style-type: none">— up to 10 W TDP— 4M Cache, 2.0 GHz base, 2.70 GHz turbo— Intel® UHD Graphics 600— Integrated memory controller— Integrated PCH Intel NUC NUC7PJYH <ul style="list-style-type: none">• Soldered-down quad-core Intel® Pentium® Silver processor J5005<ul style="list-style-type: none">— up to 10 W TDP— 4M Cache, 1.5 GHz base, 2.80 GHz turbo— Intel® UHD Graphics 605— Integrated memory controller— Integrated PCH
Memory	<ul style="list-style-type: none">• Support for DDR4 2133/2400 MHz SO-DIMMs• Support for 4 Gb and 8 Gb memory technology• Support for up to 8 GB of system memory with two SO-DIMMs• Support for non-ECC memory• Support for 1.2 V low voltage JEDEC memory• 4 GB DDR4 2400 MHz SO-DIMM pre-installed (<i>included in Intel NUC Mini PC NUC7CJYS only</i>)
Graphics	<ul style="list-style-type: none">• Integrated graphics support with Intel® UHD Graphics Technology:<ul style="list-style-type: none">— Two High Definition Multimedia Interface* (HDMI*) 2.0a full-sized back panel connectors— 4K support, at 60 Hz
Audio	<ul style="list-style-type: none">• Intel® High Definition (Intel® HD) Audio via the HDMI v2.0 interfaces supporting compressed 7.1 digital audio• Realtek ALC233 HD Audio via a stereo microphone/headphone 3.5 mm jack on the front panel• Compressed 5.1 digital audio through a mini-TOSLINK jack on the back panel• Digital microphone (DMIC) array header for support of digital voice assistants, such as Microsoft* Cortana* and Amazon* Alexa* (<i>dual digital array microphones are included with Intel® NUC Kits NUC7CJYH/NUC7PJYH and Intel® NUC Mini PC NUC7CJYS; not included with board-only SKUs</i>)

continued

Table 1. Feature Summary (continued)

Peripheral Interfaces	<ul style="list-style-type: none"> • USB 3.0 ports: <ul style="list-style-type: none"> — Two ports are implemented with external front panel connectors (one blue and one amber charging capable) — Two ports are implemented with external back panel connectors (blue) • USB 2.0 ports: <ul style="list-style-type: none"> — Two ports via two single-port internal 1x4 1.25 mm pitch headers (white) • Consumer Infrared (CIR) • Auxiliary power (AUX_PWR) – provides 1A of 5 VSB and DC_{IN} power • Consumer Electronics Control (CEC) header • Front panel header
Storage	<ul style="list-style-type: none"> • One SATA 6.0 Gbps port (black) <ul style="list-style-type: none"> — Supports one 2.5" SSD or HDD up to 9.5mm • One full-sized SDXC slot • 32 GB embedded MultiMediaCard (e-MMC) onboard storage module (included in Intel NUC Mini PC NUC7CJYS only)
BIOS	<ul style="list-style-type: none"> • Intel[®] BIOS resident in the Serial Peripheral Interface (SPI) Flash device • Support for Advanced Configuration and Power Interface (ACPI), Plug and Play, and System Management BIOS (SMBIOS)
LAN Support	Gigabit (10/100/1000 Mbps) LAN subsystem using the Realtek [®] 8111H-CG Gigabit Ethernet Controller
Hardware Monitor Subsystem	<p>Hardware monitoring subsystem, based on an ITE[®] IT8987VG embedded controller, including:</p> <ul style="list-style-type: none"> • Voltage sense to detect out of range power supply voltages • Thermal sense to detect out of range thermal values • One processor fan header • Fan sense input used to monitor fan activity • Simple fan speed control
Wireless	<p>Intel[®] Wireless-AC 9462-D2W module</p> <ul style="list-style-type: none"> • 802.11ac, Dual Band, 1x1 (Diversity) Wi-Fi + Dual Mode Bluetooth 5 • Maximum Transfer speed up to 433 Mbps • Supports Intel[®] Smart Connect Technology • Soldered-down module
Operating System	<p>Supports Microsoft[®] Windows[®] 10 Home and Microsoft[®] Windows[®] 10 Pro</p> <ul style="list-style-type: none"> • Intel NUC Mini PC NUC7CJYS comes with Windows 10 Home pre-installed on an e-MMC storage device • Only UEFI-enabled operating systems are supported. Legacy operating systems are not supported. Please check your OS distributor for support details.
Additional Features	<ul style="list-style-type: none"> • Integrated HDMI CEC (HDMI 1 only) • Intel[®] Platform Trust Technology (Intel PTT) Generation 3

1.1.2 Board Layout (Top)

Figure 1 shows the location of the major components on the top-side of Intel NUC Boards NUC7CJYB/NUC7PJYB.

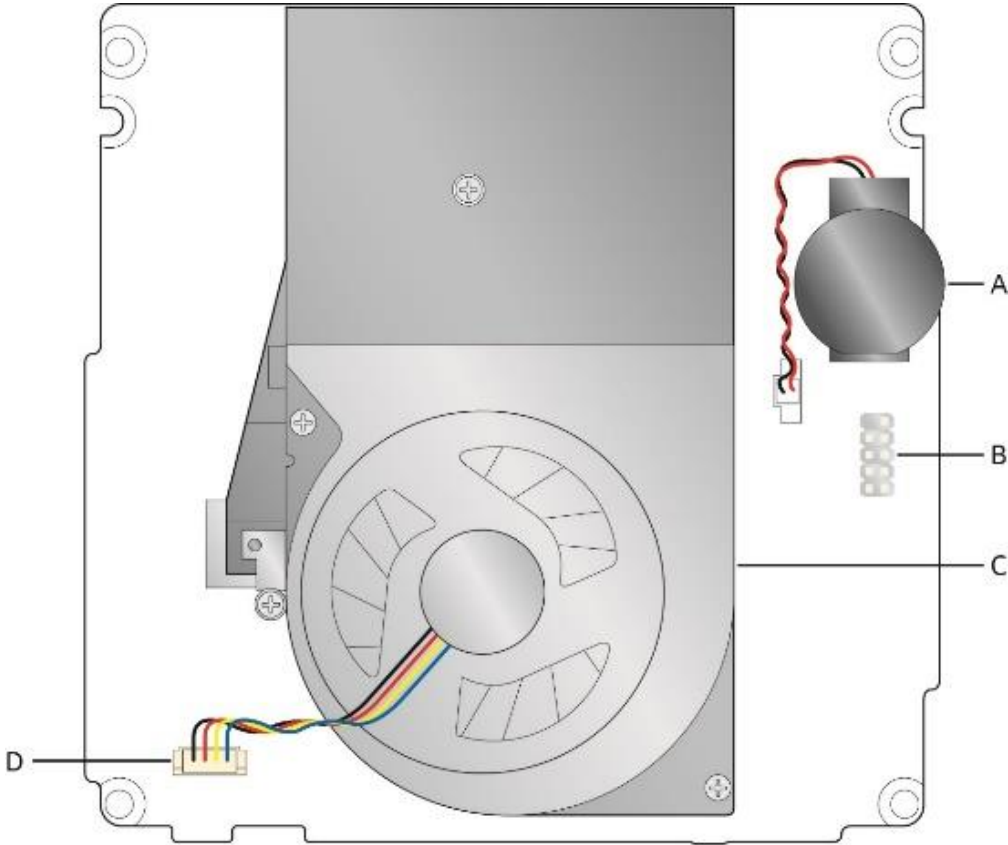

24351

Figure 1. Major Board Components (Top)

Table 2 lists the components identified in Figure 1.

Table 2. Components Shown in Figure 1

Item from Figure 1	Description
A	Battery (lithium coin cell, CR2032, 3.0V)
B	LPC Debug header (not stuffed on production boards)
C	Thermal solution
D	Processor fan header

1.1.3 Board Layout (Bottom)

Figure 2 shows the location of the major components on the bottom-side of Intel NUC Boards NUC7CJYB/NUC7PJYB.

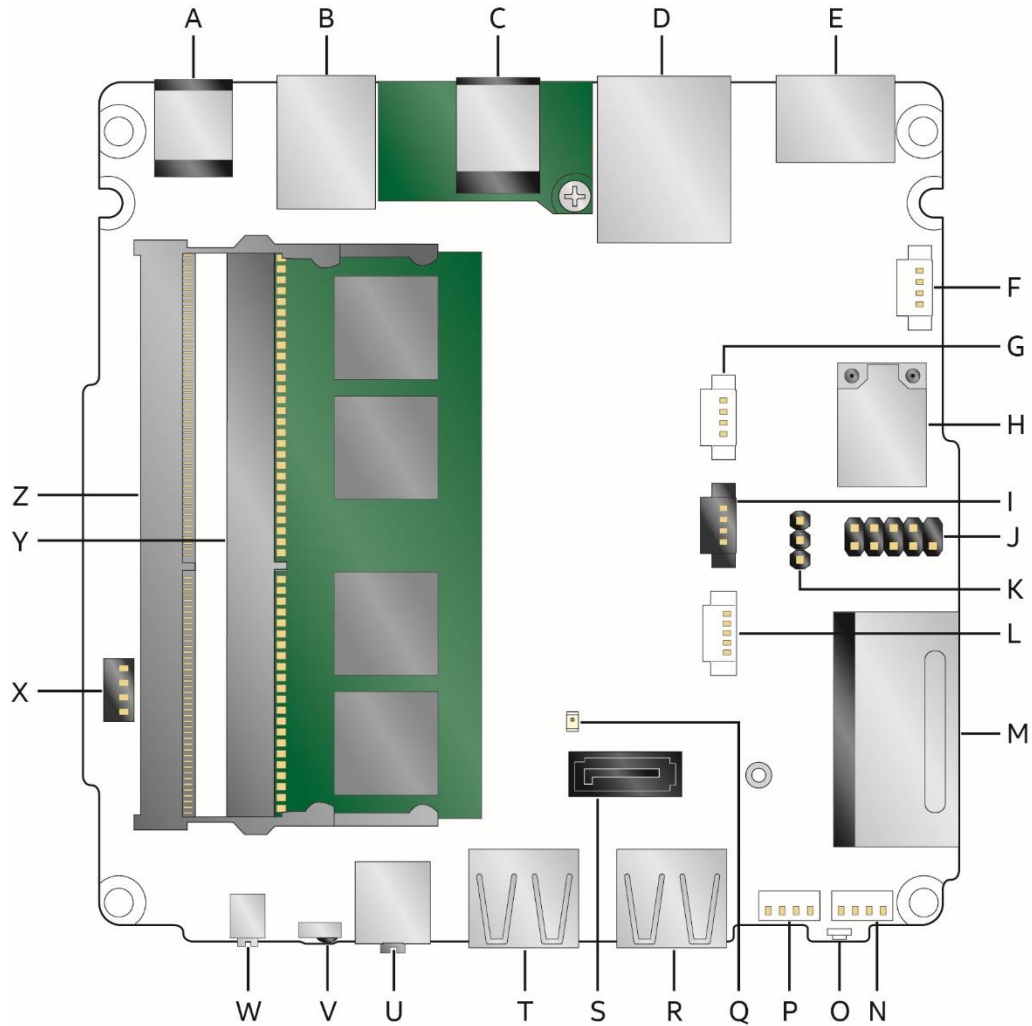

24350

Figure 2. Major Board Components (Bottom)

Table 3. Components Shown in Figure 2

Item from Figure 2	Description
A	12 - 19V DC input jack
B	Back panel USB 3.0 connectors
C	Back panel TOSLINK stereo jack/HDMI 2 connector
D	LAN jack
E	HDMI 1 connector
F	Auxiliary power connector (AUX_PWR) (1.25 mm pitch)
G	Digital microphone array (DMICS) connector (1.25 mm pitch)
H	Intel Wireless-AC 9462-D2W wireless LAN module
I	RGB LED header (RGB_LED) (1.25 mm pitch)
J	Front panel header (1.25 mm pitch)
K	BIOS security jumper
L	SATA power connector (1.25 mm pitch)
M	SDXC card reader slot
N	Front panel single-port USB 2.0 connector (1.25 mm pitch)
O	HDD LED
P	Front panel single-port USB 2.0 connector (1.25 mm pitch)
Q	+5 V Standby Power Indicator LED
R	Front panel USB 3.0 connector, charging capable (amber)
S	SATA 6.0 Gb/s connector
T	Front panel USB 3.0 connector (blue)
U	Front panel stereo speaker/headphone/microphone jack
V	Consumer Infrared (CIR) sensor
W	Power button / power LED
X	Consumer Electronic Control (CEC) connector
Y,Z	Dual DDR4 SO-DIMM sockets (SO-DIMM shown for illustration purposes; SO-DIMM supplied with Intel NUC Mini PC NUC7CJYS only)

1.1.4 Block Diagram

Figure 3 is a block diagram of the major functional areas of the board.

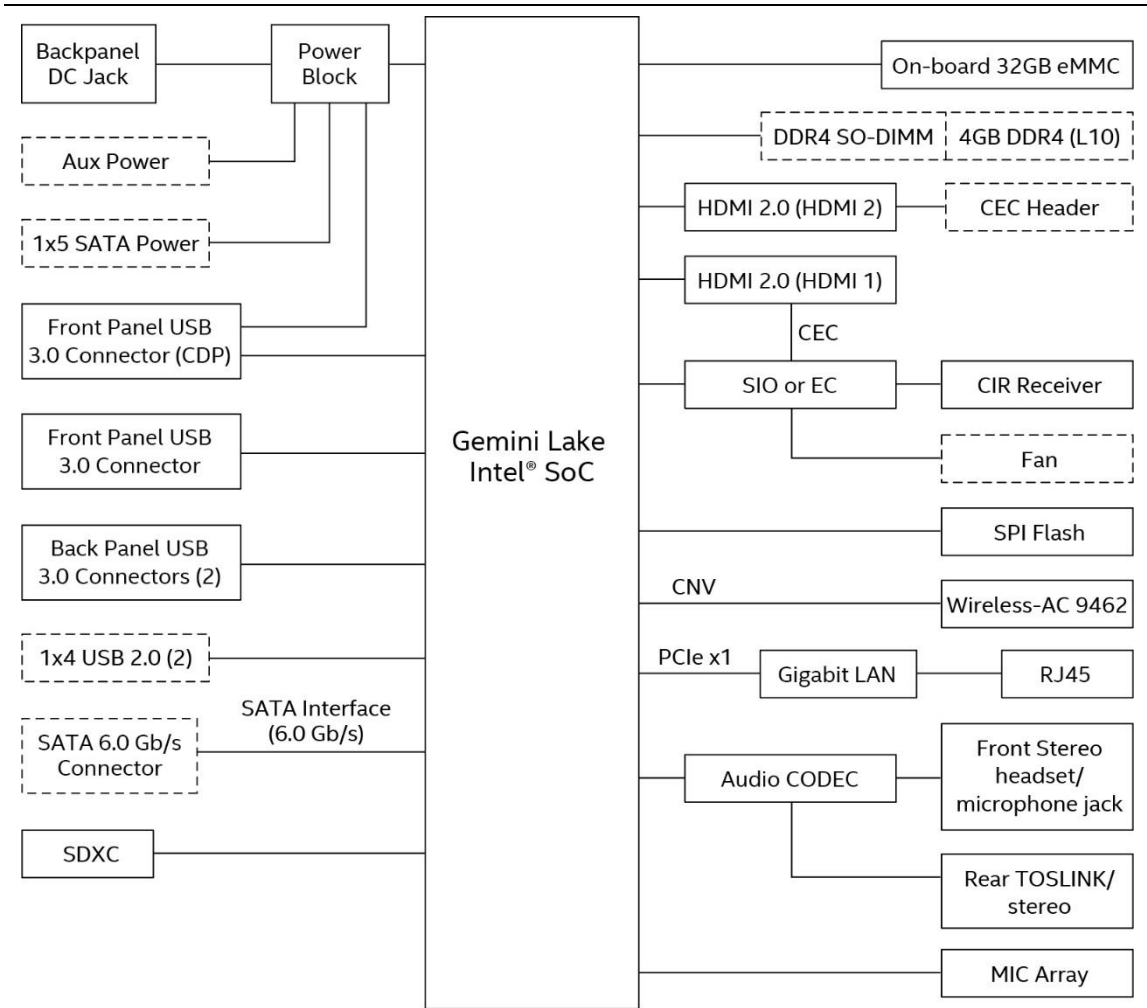

24352

Figure 3. Block Diagram

1.2 Online Support

To find information about...

Intel NUC Products NUC7CJY/NUC7PJY
NUC Board Support
Available configurations for Intel NUC Products
NUC7CJY/NUC7PJY
BIOS and driver updates
Tested memory
Integration information

Visit this World Wide Web site:

<http://www.intel.com/NUC>
<http://www.intel.com/NUCSupport>
<http://ark.intel.com>

<http://downloadcenter.intel.com>
<http://www.intel.com/NUCSupport>
<http://www.intel.com/NUCSupport>

1.3 Processor

Intel NUC Kit NUC7CJYH, Intel NUC Mini PC NUC7CJS and Intel NUC Board NUC7CJYB have a soldered-down System-on-a-Chip (SoC), which consists of:

- Dual-core Intel Celeron processor J4005
- Up to 10 W TDP
- 4M Cache, 2.0 GHz base, 2.70 GHz turbo
- Intel® UHD Graphics 600
- Integrated memory controller
- Integrated PCH

Intel NUC Kit NUC7PJY has a soldered-down System-on-a-Chip (SoC), which consists of:

- Quad-core Intel Pentium Silver processor J5005
- Up to 10 W TDP
- 4M Cache, 1.5 GHz base, 2.80 GHz turbo
- Intel® UHD Graphics 605
- Integrated memory controller
- Integrated PCH



NOTE

The board has specific requirements for providing power to the processor. Refer to Section 2.5.1 on page 51 for information on power supply requirements for the board.

1.4 System Memory

The board has two 260-pin SO-DIMM sockets and supports the following memory features:

- 1.2 V DDR4 2133/2400 MHz SDRAM non-ECC SO-DIMM with gold plated contacts
- Two memory channels
- Unbuffered, single-sided or double-sided SO-DIMMs using 4 Gb or 8 Gb technology (density)
- 8 GB maximum total system memory (with 4 Gb or 8 Gb memory technology). Refer to Section 2.1.1 on page 37 for information on the total amount of addressable memory.
- Minimum recommended total system memory: 2048 MB
- Serial Presence Detect
- Optional 4 GB DDR4 2400 MHz SO-DIMM pre-installed (**included in Intel NUC Mini PC NUC7CJYS only**)



NOTE

To be fully compliant with all applicable DDR SDRAM memory specifications, the board should be populated with SO-DIMMs that support the Serial Presence Detect (SPD) data structure. This allows the BIOS to read the SPD data and program the chipset to accurately configure memory settings for optimum performance. If non-SPD memory is installed, the BIOS will attempt to correctly configure the memory settings, but performance and reliability may be impacted or the SO-DIMMs may not function under the determined frequency.



NOTE

Intel NUC Products NUC7CJY/NUC7PJY support only 4 Gb and 8 Gb memory technologies (also referred to as “SDRAM density”). Table 4 lists the supported SO-DIMM configurations. Table 5 lists the SO-DIMM configurations that are **not** supported.

Table 4. Supported Memory Configurations

SO-DIMM Capacity	Configuration ^(Note)	SDRAM Density	SDRAM Organization Front-side/Back-side	Number of SDRAM Devices
2048 MB	SS	4 Gbit	512 M x4/empty	4
4096 MB	DS	4 Gbit	512 M x4/512 M x4	8
4096 MB	SS	8 Gbit	1024 M x4/empty	4
8192 MB	DS	4 Gbit	512 M x8/512 M x8	16
8192 MB	DS	8 Gbit	1024 M x4/1024 M x4	8

Note: “DS” refers to double-sided memory modules and “SS” refers to single-sided memory modules.

Table 5. Unsupported Memory Configurations

SO-DIMM Capacity	Configuration ^(Note)	SDRAM Density	SDRAM Organization Front-side/Back-side	Number of SDRAM Devices
1024 MB	SS	1 Gbit	128 M x8/empty	8
2048 MB	DS	1 Gbit	128 M x8/128 M x8	16
2048 MB	SS	2 Gbit	256 M x8/empty	8
4096 MB	DS	2 Gbit	256 M x8/256 M x8	16

Note: “DS” refers to double-sided memory modules and “SS” refers to single-sided memory modules.

Figure 4 illustrates the memory channel and SO-DIMM configuration.

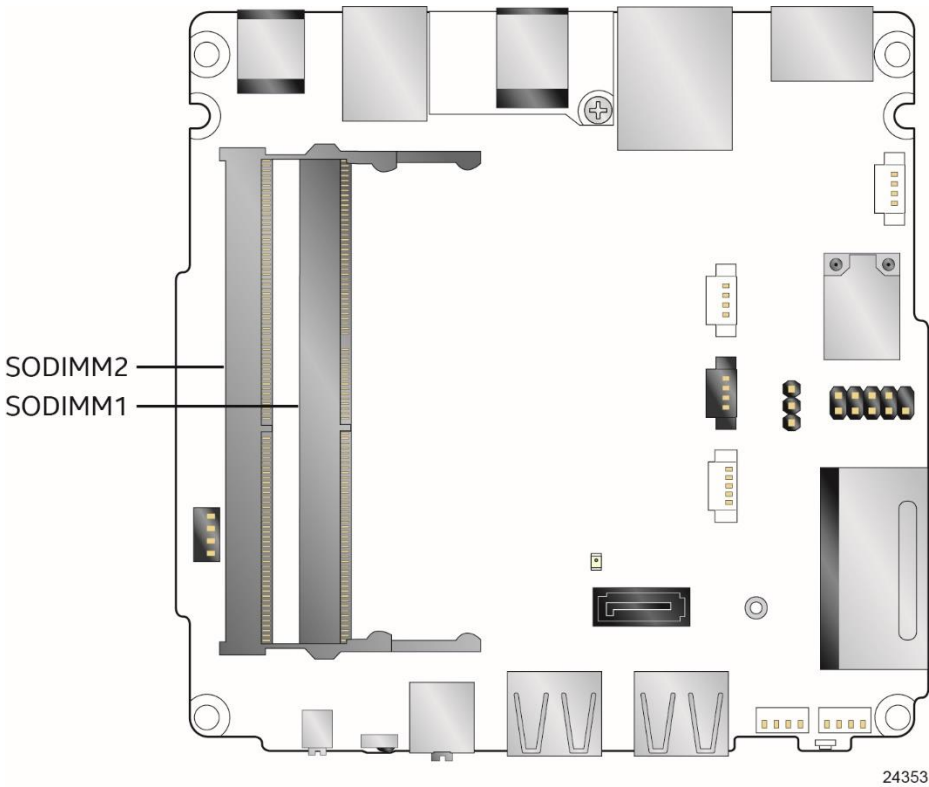

Figure 4. Memory Channel and SO-DIMM Configuration

For information about...	Refer to:
Tested Memory	http://www.intel.com/NUCSupport

1.5 Processor Graphics Subsystem

The board supports dual HDMI integrated graphics via the processor.

1.5.1 Intel® Ultra-High Definition (Intel® UHD) Graphics

The Intel UHD graphics controller features the following:

- 3D rendering, media compositing, and video encoding.
- 3D graphics hardware acceleration supporting DirectX* 9.3/10/11.3/12, OpenCL* 2.0, OGL ES 3.1, OpenGL* 4.3
- Video decode hardware acceleration supporting H.265/HEVC @ Level 5.1 8b/10b, H.264 @ Level 5.2, MPEG2, MVC, VC-1, WMV9, JPEG, VP8 and VP9 formats
- Video encode hardware acceleration supporting H.265/HEVC @ Level 4 8b, H.264 @ Level 5.2, JPEG, MVC, VP8 and VP9 (SW only) formats
- Supports content protection using High-Bandwidth Digital Content Protection (HDCP) 2.2 and PAVP 2.0.
- 4x anti-aliasing.

1.5.1.1 Video Memory Allocation

Intel® Dynamic Video Memory Technology (DVMT) is a method for dynamically allocating system memory for use as graphics memory to balance 2D/3D graphics and system performance. If your computer is configured to use DVMT, graphics memory is allocated based on system requirements and application demands (up to the configured maximum amount). When memory is no longer needed by an application, the dynamically allocated portion of memory is returned to the operating system for other uses.

1.5.2 High Definition Multimedia Interface* (HDMI*)

The HDMI ports are compliant with the HDMI 2.0a specification. The HDMI ports support standard, enhanced, or high definition video, plus multi-channel digital audio on a single cable. The ports are compatible with all ATSC and DVB HDTV standards and support eight full-range channels of lossless audio formats. The maximum supported resolution is 4096 x 2160 @ 60 Hz, 24 bpp. Maximum DDI data rate is 5.94 Gbps.

1.5.2.1.1 Integrated Audio Provided by the HDMI Interfaces

The following audio technologies are supported by the HDMI 2.0a interfaces directly from the SoC:

- AC3 - Dolby* Digital
- Dolby Digital Plus

1.6 USB

The USB port arrangement is as follows:

- USB 3.0 ports:
 - Two ports are implemented with external front panel connectors (one blue and one amber charging capable)
 - Two ports are implemented with external back panel connectors (blue)
 - Maximum current is 900 mA for each blue port, 1.5 A for the amber charging port
- USB 2.0 ports:
 - Two ports via two single-port internal 1x4 1.25 mm pitch headers (white)
 - Maximum current is 500 mA for each port of the white headers (1 A total)

All the USB ports are high-speed, full-speed, and low-speed capable.



NOTE

Computer systems that have an unshielded cable attached to a USB port may not meet FCC Class B requirements, even if no device is attached to the cable. Use a shielded cable that meets the requirements for full-speed devices.

For information about	Refer to
The location of the USB connectors on the back panel	Figure 12, page 38
The location of the USB connector on the front panel	Figure 2, page 14

1.7 SATA Interface

The SoC provides one SATA port with a theoretical maximum transfer rate of 6.0 Gb/s. A point-to-point interface is used for host to device connections.

1.7.1 AHCI Mode

The board supports AHCI storage mode.



NOTE

Microsoft Windows* 10 includes the necessary AHCI drivers without the need to install separate AHCI drivers during the operating system installation process. However, it is always good practice to update the AHCI drivers to the latest available by Intel.*

1.8 Embedded MultiMediaCard (e-MMC) - optional

The **Intel NUC Mini PC NUC7CJYS** contains a 32 GB Embedded MultiMediaCard (e-MMC) onboard storage module with Windows 10 Home operating system preinstalled. The **Intel NUC Kit NUC7CJYH** and **Intel NUC Kit NUC7PJYH** do not contain e-MMC storage nor Windows 10 preinstalled.

1.9 Real-Time Clock Subsystem

A coin-cell lithium battery (CR2032) powers the real-time clock and CMOS memory. When the computer is not plugged into a wall socket, the battery has an estimated life of three years. When the computer is plugged in, the standby current from the power supply extends the life of the battery. The clock is accurate to ± 13 minutes/year at 25 °C with 3.3 VSB applied via the power supply 5 V STBY rail.



NOTE

If the battery and AC power fail, date and time values will be reset and the user will be notified during the POST.

When the voltage drops below a certain level, the BIOS Setup program settings stored in CMOS RAM (for example, the date and time) might not be accurate. Replace the battery with an equivalent one. Figure 1 on page 13 shows the location of the battery.

1.10 Audio Subsystem

The product supports Intel HD Audio via the Realtek ALC233 audio codec. The audio subsystem supports the following features:

- Analog line-out/Analog Headphone/Analog Microphone jack on the front panel
- High Definition Audio via a stereo microphone/headphone/optical jack on the back panel
- Support for 44.1 kHz/48 kHz/96 kHz sample rates on all analog outputs
- Support for 44.1 kHz/48 kHz/96 kHz sample rates on all analog inputs
- Support for digital microphone (DMIC) array via onboard header
- Back Panel Audio Jack Support (see Figure 5 for 3.5 mm audio jack pin out):
 - Speakers only
 - Headphones only
 - Microphone only
 - Combo Headphone/Microphone
 - Mini-TOSLINK support (see section 1.10.2 for details)
- Front Panel Audio Jack Support (see Figure 5 for 3.5 mm audio jack pin out):
 - Speakers only
 - Headphones only
 - Microphone only
 - Combo Headphone/Microphone



Pin Number	Pin Name	Description
1	Tip	Left Audio Out
2	Ring	Right Audio Out
3	Ring	Common/Ground
4	Sleeve	Audio In

Figure 5. 4-Pin 3.5 mm (1/8 inch) Audio Jack Pin Out



NOTE

The analog circuit of the back panel audio connector is designed to power headphones or amplified speakers only. Poor audio quality occurs if passive (nonamplified) speakers are connected to this output.

1.10.1 Digital Microphone Array

The product supports a digital microphone (DMIC) array header for use of digital voice assistants, such as Microsoft* Cortana. **Intel NUC Kit NUC7CJYH**, **Intel NUC Kit NUC7PJYH** and **Intel NUC Mini PC NUC7CJYS** include dual digital array microphones mounted in the chassis on either side of the front panel.

1.10.2 Mini-TOSLINK Interface

The 3.5 mm audio jack also provides TOSLINK optical digital audio output.

- Mini-TOSLINK interface (back panel) plus analog audio out
 - PCM datastream support
 - S/PDIF datastream support
 - Mini-TOSLINK adaptor (not included) necessary to connect to standard TOSLINK cable
 - Stereo audio out

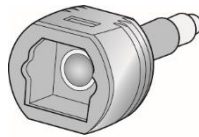

OM24169

Figure 6. Mini-TOSLINK Adaptor (not included)

1.10.3 Audio Subsystem Software

Audio software and drivers are available from Intel's World Wide Web site.

For information about	Refer to
Obtaining Audio software and drivers	http://downloadcenter.intel.com

1.11 LAN Subsystem

The LAN subsystem consists of the following:

- Realtek 8111HN-CG Gigabit Ethernet Controller (10/100/1000 Mb/s)
- RJ-45 LAN connector with integrated status LEDs
- Intel® Wireless-AC 9462-D2W module

Additional features of the LAN subsystem include:

- CSMA/CD protocol engine
- Jumbo frame support 9K
- LAN connect interface between the SoC and the LAN controller
- Power management capabilities
 - ACPI technology support
 - LAN wake capabilities
- LAN subsystem software

For information about

LAN software and drivers

Refer to

<http://downloadcenter.intel.com>

1.11.1 Realtek* 8111HN Gigabit Ethernet Controller

The Realtek 8111HN Gigabit Ethernet Controller supports the following features:

- 10/100/1000 BASE-T IEEE 802.3 compliant
- Energy Efficient Ethernet (EEE) IEEE802.3az support (Low Power Idle (LPI) mode)
- Dual interconnect between the Integrated LAN Controller and the Physical Layer (PHY):
 - PCI Express-based interface for active state operation (S0) state
 - SMBUS for host and management traffic (Sx low power state)
- Compliant to IEEE 802.3x flow control support
- 802.1p and 802.1q
- TCP, IP, and UDP checksum offload (for IPv4 and IPv6)
- Full device driver compatibility

For information about

Full LAN Hardware feature set

Refer to

<http://www.realtek.com.tw/>

1.11.2 LAN Subsystem Software

LAN software and drivers are available from Intel's World Wide Web site.

For information about

Obtaining LAN software and drivers

Refer to

<http://downloadcenter.intel.com>

1.11.3 RJ-45 LAN Connector with Integrated LEDs

Two LEDs are built into the RJ-45 LAN connector (shown in Figure 7).

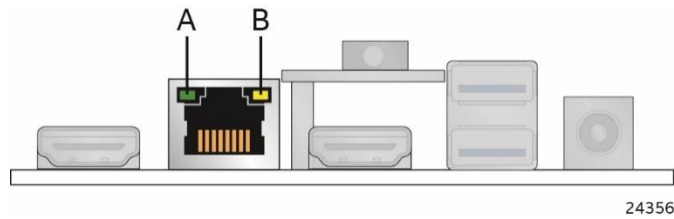

Item	Description
A	Link LED (Green)
B	Data Rate LED (Green/Yellow)

Figure 7. LAN Connector LED Locations

Table 6 describes the LED states when the board is powered up and the LAN subsystem is operating.

Table 6. LAN Connector LED States

LED	LED Color	LED State	Condition
Link (A)	Green	Off	LAN link is not established.
		On	LAN link is established.
		Blinking	LAN activity is occurring.
Data Rate (B)	Green/Yellow	Off	10 Mb/s data rate is selected.
		Green	100 Mb/s data rate is selected.
		Yellow	1000 Mb/s data rate is selected.

1.11.4 Wireless Network Module

The Intel Wireless-AC 9462-D2W module provides hi-speed wireless connectivity with the following capabilities:

- 802.11ac, Dual Band, 1x1 (Diversity) Wi-Fi + Dual Mode Bluetooth 5.0
- Supports 2.4 Ghz and 5 Ghz bands
- Maximum transfer speed up to 433 Mbps
- FIPS9 and FISMA compliant
- Supports Intel® Smart Connect Technology
- Supports Multi-user multiple-input and multiple-output (MU-MIMO) technologies for wireless communications
- Soldered-down module
- Antenna coax connector specification is I-PEX MH4F

For information about	Refer to
Obtaining WLAN software and drivers	http://downloadcenter.intel.com
Full Specifications	http://intel.com/wireless
I-PEX MH4F coax antenna specifications	https://www.i-pek.com/Products/detail/17#!

1.12 Hardware Management Subsystem

The hardware management features enable the board to be compatible with the Wired for Management (WfM) specification. The board has several hardware management features, including thermal and voltage monitoring.

For information about	Refer to
Wired for Management (WfM) Specification	www.intel.com/design/archives/wfm/

1.12.1 Hardware Monitoring

The hardware monitoring and fan control subsystem is based on an ITE IT8987VG embedded controller, which supports the following:

- Processor and system ambient temperature monitoring
- Chassis fan speed monitoring
- Voltage monitoring of +5 V, +3.3 V, Memory Vcc (SDRAM)
- SMBus interface

1.12.2 Fan Monitoring

Fan monitoring can be implemented using third-party software.

1.12.3 Thermal Solution

Figure 8 shows the location of the thermal solution and processor fan header.

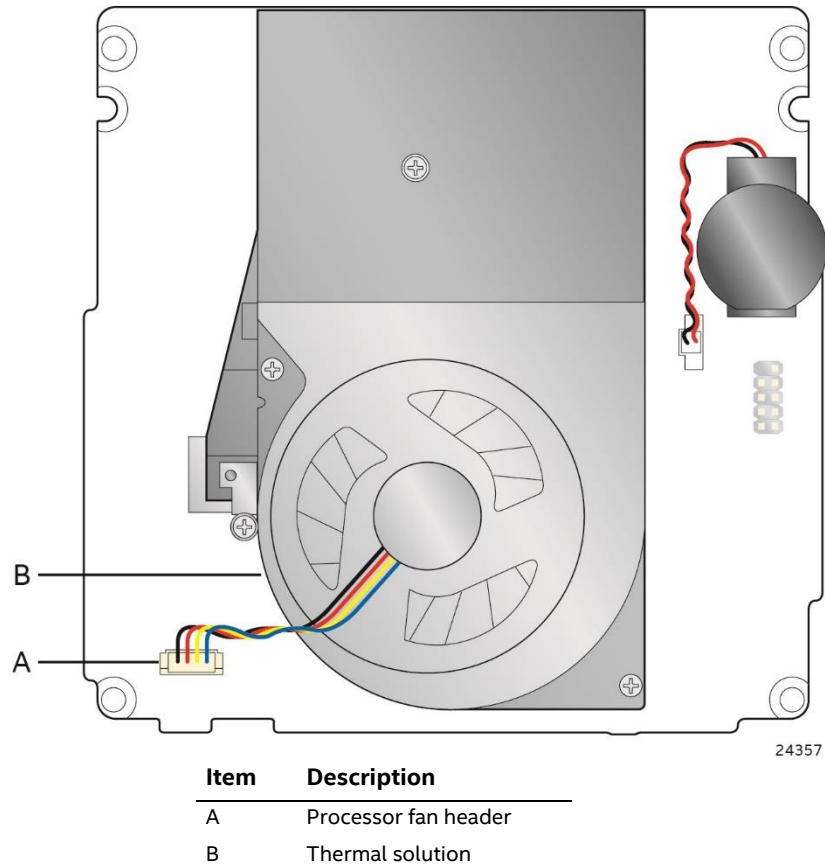

Figure 8. Thermal Solution and Fan Header

1.13 Operating System Support

Only UEFI-enabled operating systems, such as Microsoft* Windows* 10 Home and Microsoft* Windows* 10 Pro, are supported. Legacy operating systems are not supported. Please check your OS distributor for support details.

Intel NUC Mini PC NUC7CJYS comes with Windows 10 Home pre-installed on an e-MMC storage device.

1.14 Power Management

Power management is implemented at several levels, including:

- Software support through Advanced Configuration and Power Interface (ACPI)
- Hardware support:
 - Power Input
 - Instantly Available PC technology
 - LAN wake capabilities
 - Wake from USB
 - WAKE# signal wake-up support
 - Wake from S5
 - Wake from CIR
 - +5 V Standby Power Indicator LED

1.14.1 ACPI

ACPI gives the operating system direct control over the power management and Plug and Play functions of a computer. The use of ACPI with this board requires an operating system that provides full ACPI support. ACPI features include:

- Plug and Play (including bus and device enumeration)
- Power management control of individual devices, add-in boards (some add-in boards may require an ACPI-aware driver), video displays, and disk drives
- Methods for achieving less than 15-watt system operation in the power-on/standby sleeping state
- A Soft-off feature that enables the operating system to power-off the computer
- Support for multiple wake-up events (see Table 9 on page 31)
- Support for a front panel power and sleep mode switch

Table 7 lists the system states based on how long the power switch is pressed, depending on how ACPI is configured with an ACPI-aware operating system.

Table 7. Effects of Pressing the Power Switch

If the system is in this state...	...and the power switch is pressed for	...the system enters this state
Off (ACPI G2/G5 – Soft off)	Less than four seconds	Power-on (ACPI G0 – working state)
On (ACPI G0 – working state)	Less than four seconds	Soft-off/Standby (ACPI G1 – sleeping state) ^{Note}
On (ACPI G0 – working state)	More than six seconds	Fail safe power-off (ACPI G2/G5 – Soft off)
Sleep (ACPI G1 – sleeping state)	Less than four seconds	Wake-up (ACPI G0 – working state)
Sleep (ACPI G1 – sleeping state)	More than six seconds	Power-off (ACPI G2/G5 – Soft off)

Note: Depending on power management settings in the operating system.

1.14.1.1 System States and Power States

Under ACPI, the operating system directs all system and device power state transitions. The operating system puts devices in and out of low-power states based on user preferences and knowledge of how devices are being used by applications. Devices that are not being used can be turned off. The operating system uses information from applications and user settings to put the system as a whole into a low-power state.

Table 8 lists the power states supported by the board along with the associated system power targets. See the ACPI specification for a complete description of the various system and power states.

Table 8. Power States and Targeted System Power

Global States	Sleeping States	Processor States	Device States	Targeted System Power ^(Note 1)
G0 – working state	S0 – working	C0 – working	D0 – working state.	Full power
G1 – sleeping state	S3 – Suspend to RAM. Context saved to RAM.	No power	D3 – no power except for wake-up logic.	Power < 5 W ^(Note 2)
G1 – sleeping state	S4 – Suspend to disk. Context saved to disk.	No power	D3 – no power except for wake-up logic.	Power < 5 W ^(Note 2)
G2/S5	S5 – Soft off. Context not saved. Cold boot is required.	No power	D3 – no power except for wake-up logic.	Power < 5 W ^(Note 2)
G3 – mechanical off AC power is disconnected from the computer.	No power to the system.	No power	D3 – no power for wake-up logic, except when provided by battery or external source.	No power to the system. Service can be performed safely.

Notes:

1. Total system power is dependent on the system configuration, including add-in boards and peripherals powered by the system chassis' power supply.
2. Dependent on the standby power consumption of wake-up devices used in the system.

1.14.1.2 Wake-up Devices and Events

Table 9 lists the devices or specific events that can wake the computer from specific states.

Table 9. Wake-up Devices and Events

Devices/events that wake up the system...	...from this sleep state	Comments
Power switch	S3, S4, S5	
RTC alarm	S3, S4, S5 ^(Note 1)	Monitor to remain in sleep state
LAN	S3, S4, S5 ^(Notes 1, 2)	"S5 WOL after G3" must be supported; monitor to remain in sleep state
USB	S3, S4, S5 ^(Note 3, 4)	Wake S4, S5 controlled by BIOS option
PCIe via WAKE#	S3, S4, S5 ^(Note 1)	Via WAKE; monitor to remain in sleep state
Consumer IR	S3, S4, S5 ^(Notes 3, 4)	
Bluetooth	N/A	Wake from Bluetooth is not supported

Notes:

1. Monitor will remain in "sleep" state from S3 only
2. "S5 WoL after G3" supported w/Deep Sleep disabled
3. Wake from S4 and S5 only supported w/Deep Sleep disabled
4. Wake from device/event not supported immediately upon return from AC loss



NOTE

The use of these wake-up events from an ACPI state requires an operating system that provides full ACPI support. In addition, software, drivers, and peripherals must fully support ACPI wake events.

1.14.2 Hardware Support

The board provides several power management hardware features, including:

- Wake from Power Button signal
- Instantly Available PC technology
- LAN wake capabilities
- Wake from USB
- WAKE# signal wake-up support
- Wake from S5
- Wake from CIR
- +5 V Standby Power Indicator LED



NOTE

The use of Wake from USB from an ACPI state requires an operating system that provides full ACPI support.

1.14.2.1 Power Input

When resuming from an AC power failure, the computer may return to the power state it was in before power was interrupted (on or off). The computer's response can be set using the Last Power State feature in the BIOS Setup program's Boot menu.

1.14.2.2 Instantly Available PC Technology

Instantly Available PC technology enables the board to enter the ACPI S3 (Suspend-to-RAM) sleep-state. While in the S3 sleep-state, the computer will appear to be off (the power supply is off, and the front panel LED is amber if dual colored, or off if single colored.) When signaled by a wake-up device or event, the system quickly returns to its last known wake state. Table 9 lists the devices and events that can wake the computer from the S3 state.

The use of Instantly Available PC technology requires operating system support and drivers for any installed PCI Express add-in card.

1.14.2.3 LAN Wake Capabilities

LAN wake capabilities enable remote wake-up of the computer through a network. The LAN subsystem monitors network traffic at the Media Independent Interface. Upon detecting a Magic Packet* frame, the LAN subsystem asserts a wake-up signal that powers up the computer.

1.14.2.4 Wake from USB

USB bus activity wakes the computer from an ACPI S3, S4, and S5 states.



NOTE

Wake from USB requires the use of a USB peripheral that supports Wake from USB.

1.14.2.5 WAKE# Signal Wake-up Support

When the WAKE# signal on the PCI Express bus is asserted, the computer wakes from an ACPI S3, S4, or S5 state.

1.14.2.6 Wake from S5

When the RTC Date and Time is set in the BIOS, the computer will automatically wake from an ACPI S5 state.

1.14.2.7 Wake from Consumer IR

CIR activity wakes the computer from an ACPI S3, S4, or S5 state.

1.14.2.8 +5 V Standby Power Indicator LED

The standby power indicator LED shows that power is still present even when the computer appears to be off. Figure 9 shows the location of the standby power LED.

**CAUTION**

If AC power has been switched off and the standby power indicator is still lit, disconnect the power cord before installing or removing any devices connected to the board. Failure to do so could damage the board and any attached devices.

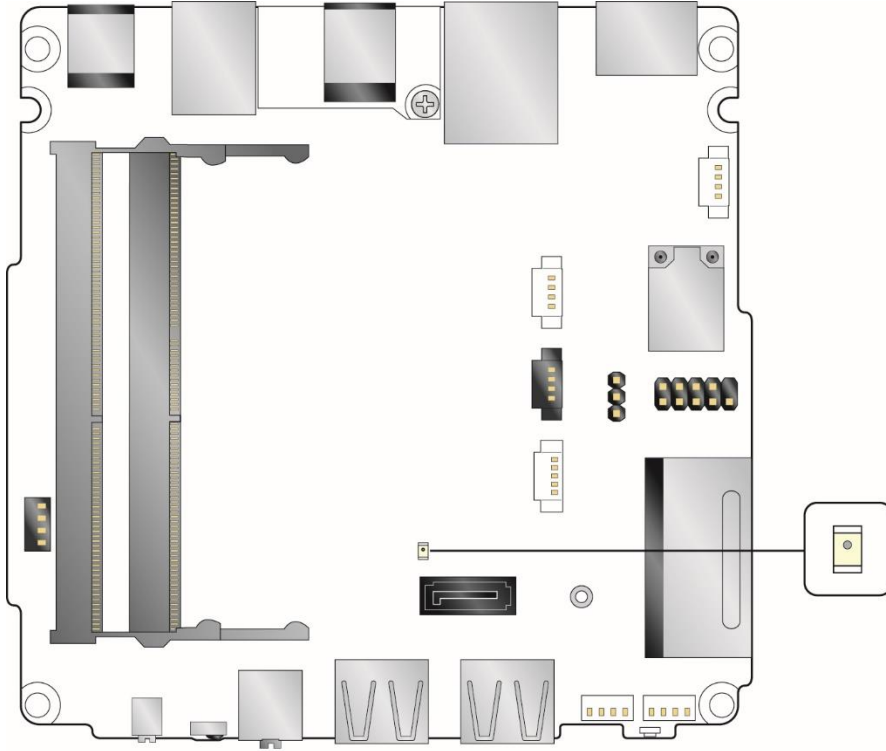

Figure 9. Location of the Standby Power LED

1.14.3 HDMI Consumer Electronics Control (CEC)

The board contains two mutually-exclusive methods for controlling HDMI CEC devices:

- External CEC adaptor connected via CEC connector (see Figure 14; pinout in Table 18).

Onboard CEC control from the embedded controller via HDMI cable connected to HDMI 1 and BIOS setup. Expected behavior is provided in Table 10 below.

Table 10. HDMI 1 CEC expected behavior

Activity	Current Status		Action	Expected Behavior
	PC ^{1,2}	TV ³		
Wake On TV	Off	Off	TV on	PC on
Standby by TV	On	On	TV Standby	PC sleep or power off ⁴
Auto Turn Off TV (S0 -> S5)	On	On	PC Shutdown	TV standby ³
Auto Turn On TV (S5 -> S0)	Off	Off	PC On	TV on ³
Auto Turn Off TV (S0 -> S3)	On	On	PC Sleep	TV standby ³
Auto Turn On TV (S3 -> S0)	Off	Off	PC On	TV on ³

Notes:

1. *HDMI CEC Control* enabled in BIOS Setup and in TV setup, if necessary. Please consult your TV's documentation.
2. *Fast Boot* and *Deep S4/S5* disabled in BIOS Setup.
3. Results seen with Panasonic LED TV VIERA TH-40A400W. Other TVs may have different results due to variable implementations of CEC features.
4. PC power off behavior dependent upon power button setting in operating system.
5. If using external CEC adaptor, onboard CEC control must be disabled in BIOS Setup.

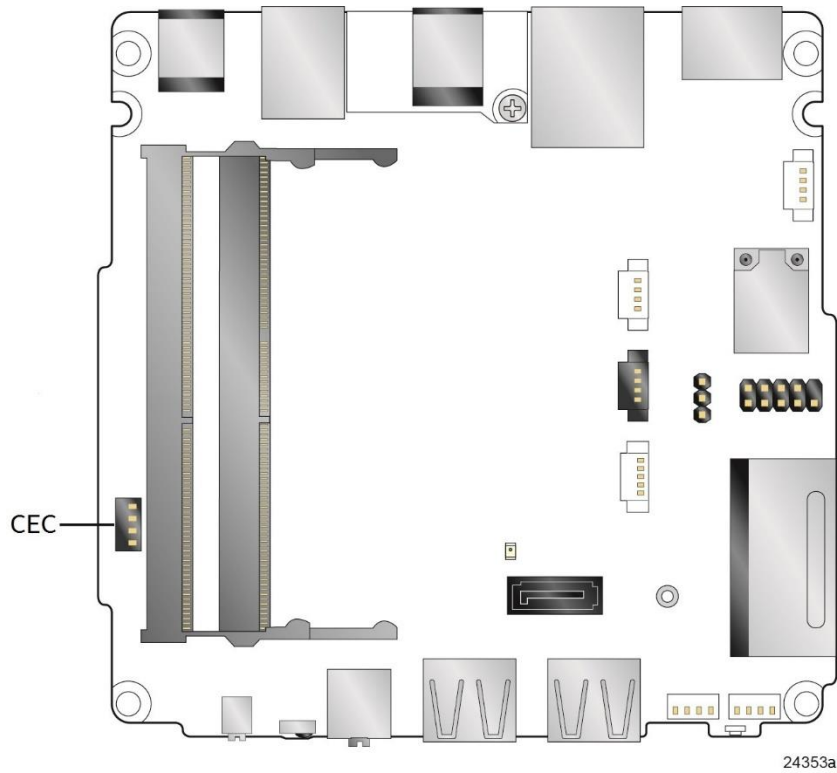

Figure 10. CEC Connector

1.15 Intel Platform Security Technologies

Intel platform security technologies provides tools and resources to help the user protect their information by creating a safer computing environment.



NOTE

Software with security capability is required to take advantage of Intel platform security technologies.

1.15.1 Intel® Virtualization Technology

Intel Virtualization Technology (Intel® VT) is a hardware-assisted technology that, when combined with software-based virtualization solutions, provides maximum system utilization by consolidating multiple environments into a single server or client.



NOTE

A processor with Intel VT does not guarantee that virtualization will work on your system. Intel VT requires a computer system with a chipset, BIOS, enabling software and/or operating system, device drivers, and applications designed for this feature.

For information about

Intel Virtualization Technology

Refer to

<http://www.intel.com/technology/virtualization/technology.htm>

1.15.2 Intel® Platform Trust Technology

Intel® Platform Trust Technology (Intel® PTT) Generation 3 is a platform functionality for credential storage and key management. Intel® PTT supports Microsoft* BitLocker* Drive Encryption for hard drive encryption and supports all Microsoft requirements for firmware Trusted Platform Module (fTPM) 2.0.



NOTE

Support for fTPM version 2.0 requires a true UEFI-enabled operating system, such as Microsoft Windows* 10.*



CAUTION

BIOS recovery using the BIOS security jumper clears Intel® Platform Trust Technology (Intel® PTT) keys. These keys will not be restored after the BIOS recovery.

For information about

Intel Platform Trust Technology

Refer to

<http://www.intel.com/content/dam/www/public/us/en/documents/white-papers/enterprise-security-platform-trust-technology-white-paper.pdf>

2 Technical Reference

2.1 Memory Resources

2.1.1 Addressable Memory

The board utilizes up to 8 GB of addressable system memory. Typically the address space that is allocated for PCI Conventional bus add-in cards, PCI Express configuration space, BIOS (SPI Flash device), and chipset overhead resides above the top of DRAM (total system memory). On a system that has 8 GB of system memory installed, it is not possible to use all of the installed memory due to system address space being allocated for other system critical functions. These functions include the following:

- BIOS/SPI Flash device (16 MB)
- Local APIC (19 MB)
- Direct Media Interface (40 MB)
- PCI Express configuration space (256 MB)
- SoC base address registers PCI Express ports (up to 256 MB)
- Memory-mapped I/O (I/O fabric) that is dynamically allocated for PCI Express add-in cards (256 MB)

The board provides the capability to reclaim the physical memory overlapped by the memory mapped I/O logical address space. The board remaps physical memory from the top of usable DRAM boundary to the 4 GB boundary to an equivalent sized logical address range located just above the 4 GB boundary. All installed system memory can be used when there is no overlap of system addresses.

2.2 Connectors and Headers



CAUTION

Only the following connectors and headers have overcurrent protection: back panel and front panel USB.

This section describes the board's connectors and headers. The connectors and headers can be divided into these groups:

- Front panel I/O connector
- Back panel I/O connectors

2.2.1 Front Panel Connectors

Figure 11 shows the location of the front panel connectors, controls and indicators for the board.

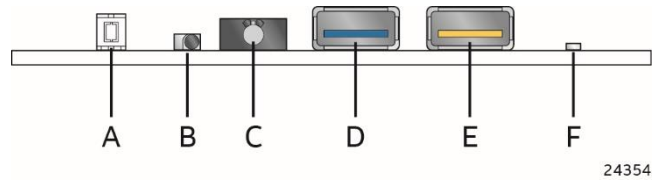

Item	Description
A	Power switch and LED
B	CIR
C	Front panel stereo microphone/headphone jack
D	USB 3.0 port (blue)
E	USB 3.0 charging-capable port (amber)
F	Hard drive activity LED

Figure 11. Front Panel Connectors, Controls and Indicators

2.2.2 Back Panel Connectors

Figure 12 shows the location of the back panel connectors for the board.

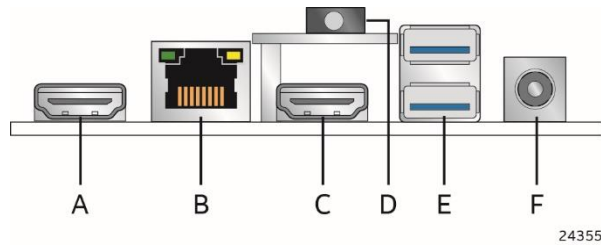

Item	Description
A	HDMI 1 connector
B	LAN
C	HDMI 2 connector
D	Back panel TOSLINK stereo jack
E	USB 3.0 ports
F	12 - 19V DC input jack

Figure 12. Back Panel Connectors

2.2.3 Headers and Connectors (Top)

Figure 13 shows the location of the headers and connectors on the top-side of the board.

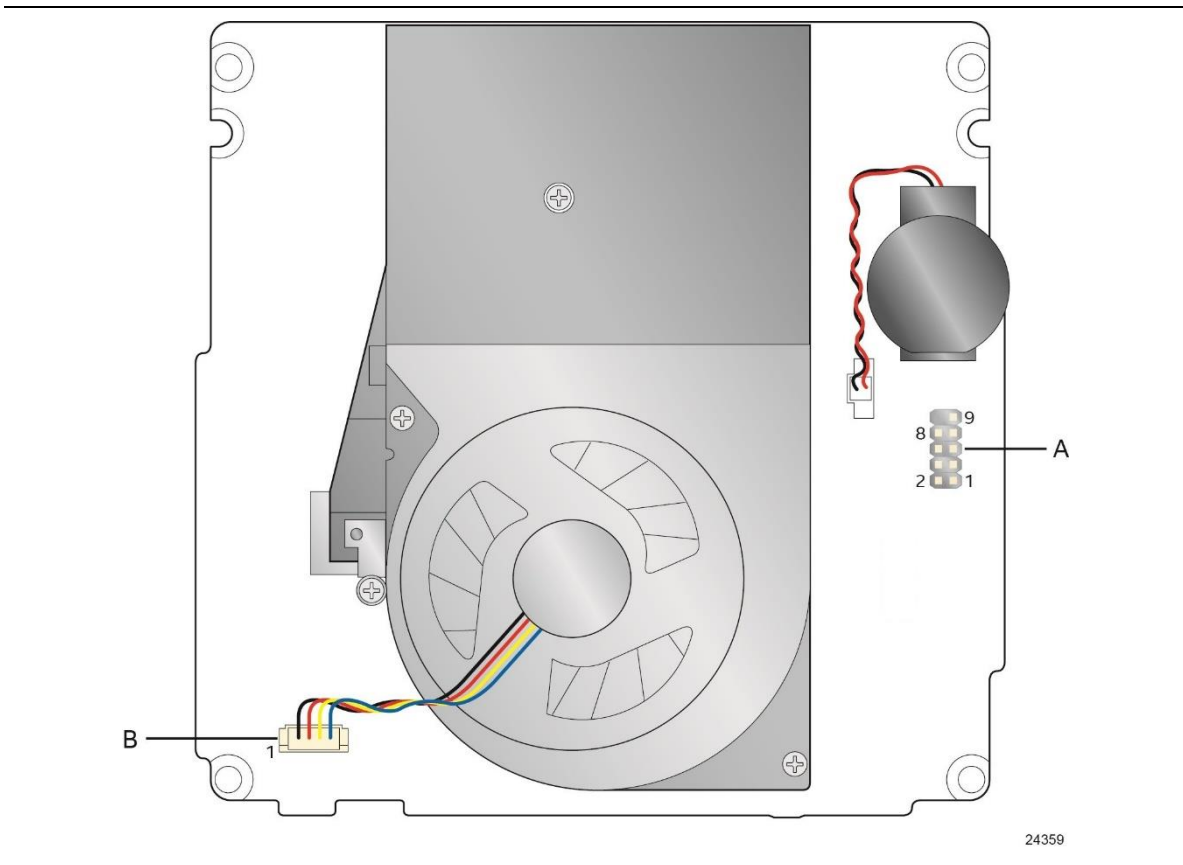

Figure 13. Headers and Connectors (Top)

Table 11 lists the headers and connectors identified in Figure 13.

Table 11. Headers and Connectors Shown in Figure 13

Item from Figure 13	Description
A	LPC debug header (not stuffed) – see Table 12
B	Processor fan header

Table 12. LPC Debug Header (2.0 mm Pitch – not stuffed)

Pin	Signal Name	Description	Pin	Signal Name	Description
1	LPC_DB_AD3	Address line 3	2	LPC_VCC3	+3.3V VCC
3	LPC_DB_AD2	Address line 2	4	DB_LPC_FRAME_L	LPC Frame
5	LPC_DB_AD1	Address line 1	6	DB_RST_L	Reset
7	LPC_DB_AD0	Address line 0	8	DB_LPC_CLK	LPC clock
9	GND	Ground	10	Key	No pin

2.2.4 Connectors and Headers (Bottom)

Figure 14 shows the locations of the connectors and headers on the bottom-side of the board.

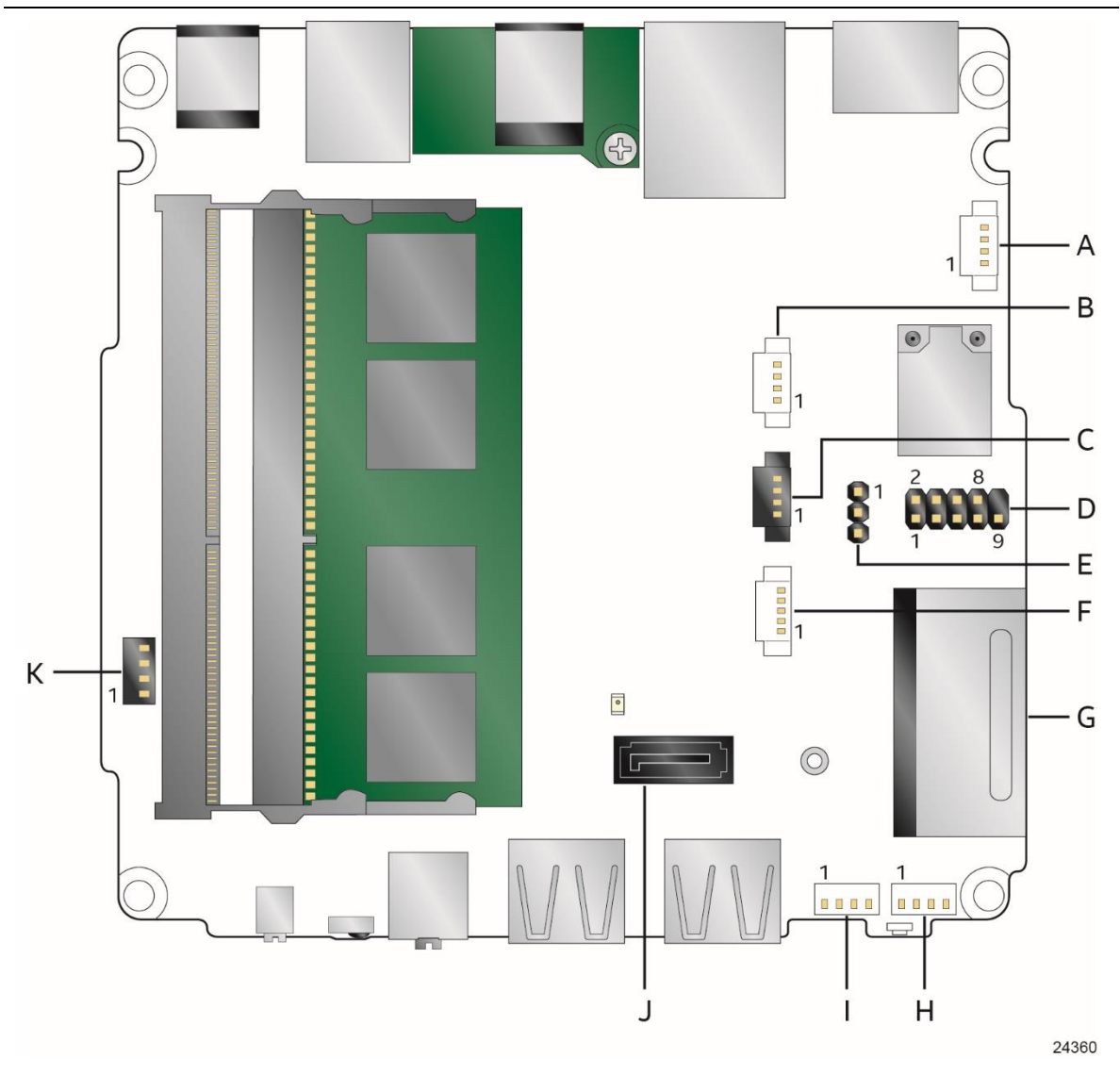

Figure 14. Connectors and Headers (Bottom)

Table 13 lists the connectors and headers identified in Figure 14.

Table 13. Connectors and Headers Shown in Figure 14

Item from Figure 14	Description
A	Auxiliary power connector (AUX_PWR) (1.25 mm pitch)
B	Digital microphone array connector (DMICS)
C	RGB LED connector (RGB_LED)
D	Auxiliary front panel connector (FRONT_PANEL) (2.0 mm pitch)
E	BIOS security jumper (BIOS_SEC)
F	SATA power connector (1.25 mm pitch)
G	SDXC slot
H, I	Front panel single-port USB 2.0 header (USB1/USB2) (1.25 mm pitch)
J	SATA 6.0 Gb/s connector (SATA)
K	Consumer Electronics Control (CEC) connector (1.25 mm pitch)

Signal Tables for the Connectors and Headers

Table 14. SATA Power Header (1.25 mm Pitch)

Pin	Signal Name
1	5 V
2	5 V
3	3.3 V
4	GND
5	GND



NOTE

Connector is Molex* part number 53398-0571, 1.25 mm pitch PicoBlade* header, surface mount, vertical, lead-free, 5 circuits.

Table 15. Single-Port Internal USB 2.0 Headers (1.25 mm Pitch)

Pin	Signal Name
1	+5 V DC
2	Data (negative)
3	Data (positive)
4	Ground

**NOTE**

- Connector is Molex part number 53398-0571, 1.25 mm pitch PicoBlade header, surface mount, vertical, lead-free, 4 circuits.
- The +5 V DC power on the USB header is fused.
- Use only an internal USB connector that conforms to the USB 2.0 specification for high-speed USB devices.

Table 16. Digital Microphone (DMICS) Array Connector (1.25 mm Pitch)

Pin	Signal Name
1	Ground
2	+3.3 V DC (+3V3_DMIC)
3	Clock (DMIC_CLK)
4	Data (DMIC_DAT)

**NOTE**

Connector is Molex part number 53398-0571, 1.25 mm pitch PicoBlade header, surface mount, vertical, lead-free, 4 circuits.

Table 17. RGB LED Connector (1.25 mm Pitch)

Pin	Signal Name
1	+3.3VSB
2	Red LED
3	Green LED
4	Blue LED

**NOTE**

Connector is Molex part number 53398-0571, 1.25 mm pitch PicoBlade header, surface mount, vertical, lead-free, 4 circuits.

Table 18. Consumer Electronics Control (CEC) Connector (1.25 mm Pitch)

Pin	Signal Name
1	+5VSB
2	Ground
3	CEC_PWR
4	HDMI_CEC



NOTE

Connector is Molex part number 53398-0571, 1.25 mm pitch PicoBlade header, surface mount, vertical, lead-free, 4 circuits.

2.2.4.1 SDXC Card Reader

The board has a standard Secure Digital (SD) card reader that supports the Secure Digital eXtended Capacity (SDXC) format, 3.01 specification.

Table 19. SDXC Card Reader Connector

Pin	Signal Name	Descriptive Name
1	CD	Card Detection
2	DATA2	Serial Data 2
3	DATA3	Serial Data 3
4	CMD	Command
5	VSS1	Ground
6	VDD	Power (3.3 V)
7	CLK	Serial Clock
8	VSS2	Ground
9	DATA0	Serial Data 0
10	DATA1	Serial Data 1
11	WP	Write Protect



NOTE

The SD card reader is not supported in Microsoft* Windows* 7

2.2.4.2 Power Supply Connector

The board has the following power supply connector:

- **External Power Supply** – the board is powered through a 12-19 V DC connector on the back panel. The back panel DC connector is compatible with a 5.5 mm/OD (outer diameter) and 2.5 mm/ID (inner diameter) plug, where the inner contact is +19 ($\pm 10\%$) V DC and the shell is GND. The maximum current rating is 3 A.



NOTE

External power voltage, 12-19 V DC, is dependent on the type of power adapter used.

Table 20. Auxiliary Power Connector

Pin	Signal Name	Descriptive Name
1	+5VSB	5V
2	PCH_GPIO24	Power draw sensor
3	GND	Ground
4	+VIN	12V – 19V DC input



NOTE

The Auxiliary Power Connector is a limited voltage source (output) for 5V Standby and the voltage supplied to the board (typically 19V DC) for use by expansion peripherals. The Auxiliary Power Connector is limited to 1.5A max total current (fused).



NOTE

Connector is JTE (JOINT TECH): A1250WV-S-04P A-Series (Wire to Board) Vertical SMT Connector, 1.25mm pitch, 1A rating. Mates with JTE A1250 Series Housing.

For information about

Power supply considerations

Refer to

Section 2.5.1, page 51

2.2.4.3 Front Panel Header (2.0 mm Pitch)

This section describes the functions of the front panel header. Table 21 lists the signal names of the front panel header. Figure 15 is a connection diagram for the front panel header.

Table 21. Front Panel Header (2.0 mm Pitch)

Pin	Signal Name	Description	Pin	Signal Name	Description
1	HDD_POWER_LED	Pull-up resistor (750 Ω) to +5V	2	POWER_LED_MAIN	[Out] Front panel LED (main color)
3	HDD_LED#	[Out] Hard disk activity LED	4	POWER_LED_ALT	[Out] Front panel LED (alt color)
5	GROUND	Ground	6	POWER_SWITCH#	[In] Power switch
7	RESET_SWITCH#	[In] Reset switch	8	GROUND	Ground
9	+5V_DC	Power (2A)	10	Key	No pin

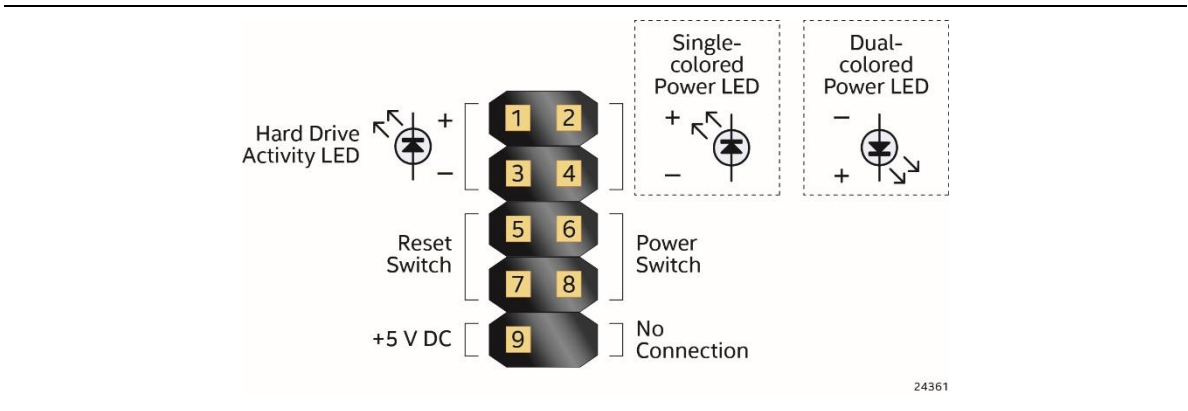

Figure 15. Connection Diagram for Front Panel Header (2.0 mm Pitch)

2.2.4.3.1 Hard Drive Activity LED Header

Pins 1 and 3 can be connected to an LED to provide a visual indicator that data is being read from or written to a hard drive. Proper LED function requires a SATA hard drive or optical drive connected to an onboard SATA connector.

2.2.4.3.2 Reset Switch Header

Pins 5 and 7 can be connected to a momentary single pole, single throw (SPST) type switch that is normally open. When the switch is closed, the board resets and runs the POST.

2.2.4.3.3 Power/Sleep LED Header

Pins 2 and 4 can be connected to a one- or two-color LED. Table 22 and Table 23 show the possible LED states.

Table 22. States for a One-Color Power LED

LED State	Description
Off	Power off
Blinking	Standby
Steady	Normal operation

Table 23. States for a Dual-Color Power LED

LED State	Description
Off	Power off
Secondary color blinking (amber)	Standby
Primary color steady (blue)	Normal operation



NOTE

The LED behavior shown in Table 22 is default – other patterns may be set via BIOS setup.

2.2.4.3.4 Power Switch Header

Pins 6 and 8 can be connected to a front panel momentary-contact power switch. The switch must pull the SW_ON# pin to ground for at least 50 ms to signal the power supply to switch on or off. (The time requirement is due to internal debounce circuitry on the board.) At least two seconds must pass before the power supply will recognize another on/off signal.

2.2.4.3.5 5V DC Power Header

Pin 6 can supply 2A of 5V DC (VCC) power. Any usage of power from this header should be considered when calculating the system's total power budget.

For information about

Power supply considerations

Refer to

Section 2.5.1, page 51

2.2.4.4 Consumer Infrared (CIR) Sensor

The Consumer Infrared (CIR) sensor on the front panel provides features that are designed to comply with Microsoft Consumer Infrared usage models.

The CIR feature is made up of the receiving sensor. The receiving sensor consists of a filtered translated infrared input compliant with Microsoft CIR specifications.

Customers are required to provide their own media center compatible remote or smart phone application for use with the Intel NUC. Figure 16 shows the location of the CIR sensor.

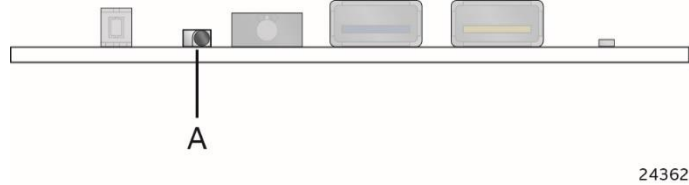

24362

Item	Description
A	CIR Sensor

Figure 16. Location of the CIR Sensor

2.3 BIOS Security Jumper



CAUTION

Do not move a jumper with the power on. Always turn off the power and unplug the power cord from the computer before changing a jumper setting. Otherwise, the board could be damaged.

Figure 17 shows the location of the BIOS security jumper. The 3-pin jumper determines the BIOS Security program's mode. Table 24 describes the BIOS security jumper settings for the three modes: normal, lockdown, and configuration.

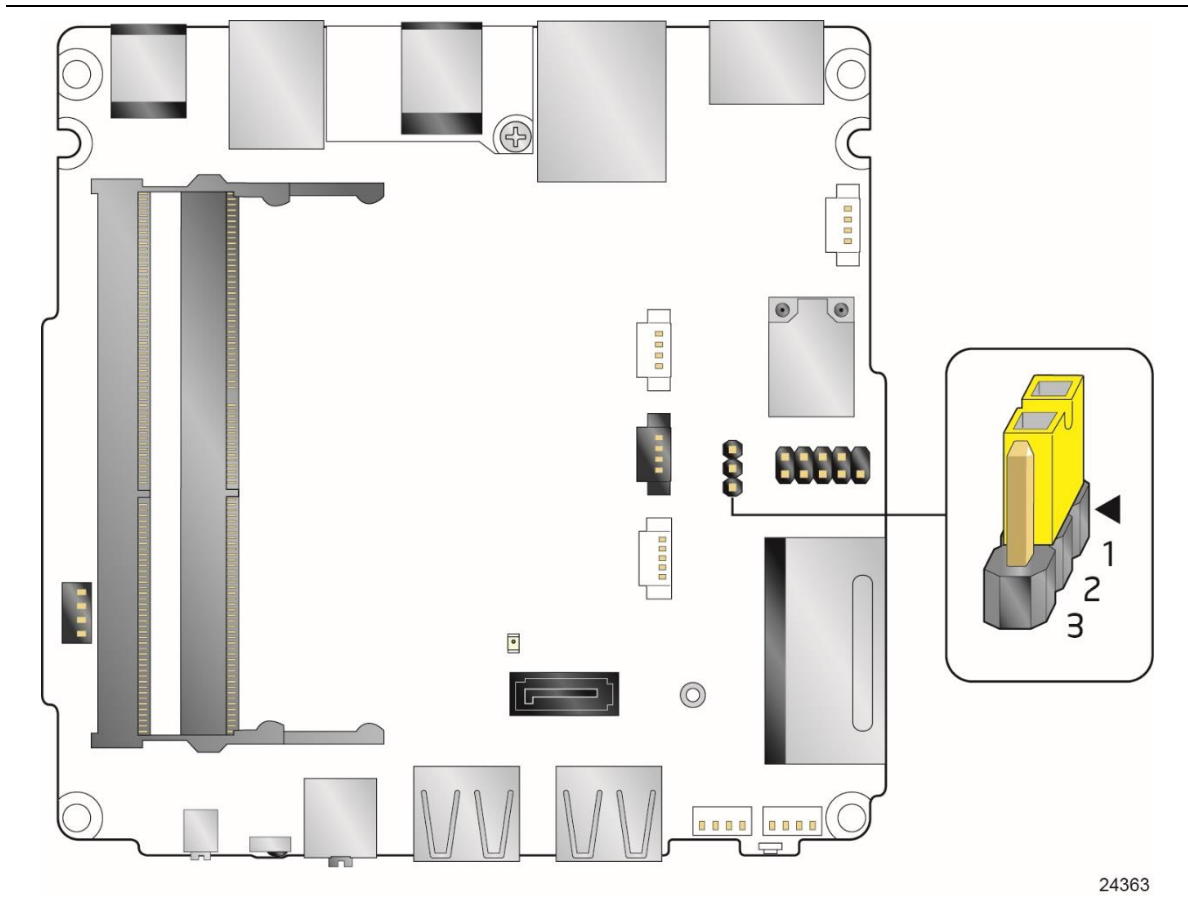

Figure 17. Location of the BIOS Security Jumper

Table 24. BIOS Security Jumper Settings

Function/Mode	Jumper Setting	Configuration
Normal	1-2	The BIOS uses current configuration information and passwords for booting.
Lockdown	2-3	<p>The BIOS uses current configuration information and passwords for booting, except:</p> <ul style="list-style-type: none"> • All POST Hotkeys are suppressed (prompts are not displayed and keys are not accepted. For example, F2 for Setup, F10 for the Boot Menu). • Power Button Menu is not available (see Section 3.7.4 Power Button Menu). <p>BIOS updates are not available except for automatic Recovery due to flash corruption.</p>
Configuration	None	<p>BIOS Recovery Update process if a matching *.bio file is found. Recovery Update can be cancelled by pressing the Esc key.</p> <p>If the Recovery Update was cancelled or a matching *.bio file was not found, a Config Menu will be displayed. The Config Menu consists of the following (followed by the Power Button Menu selections):</p> <p>[1] Suppress this menu until the BIOS Security Jumper is replaced.</p> <p>[2] Clear BIOS User and Supervisor Passwords.</p> <p>See Section 3.7.4 Power Button Menu.</p>

2.4 Mechanical Considerations

2.4.1 Form Factor

The board is designed to fit into a custom chassis. Figure 18 illustrates the mechanical form factor for the board. Dimensions are given in millimeters. The outer dimensions are 101.60 millimeters by 101.60 millimeters [4.0 inches by 4.0 inches].

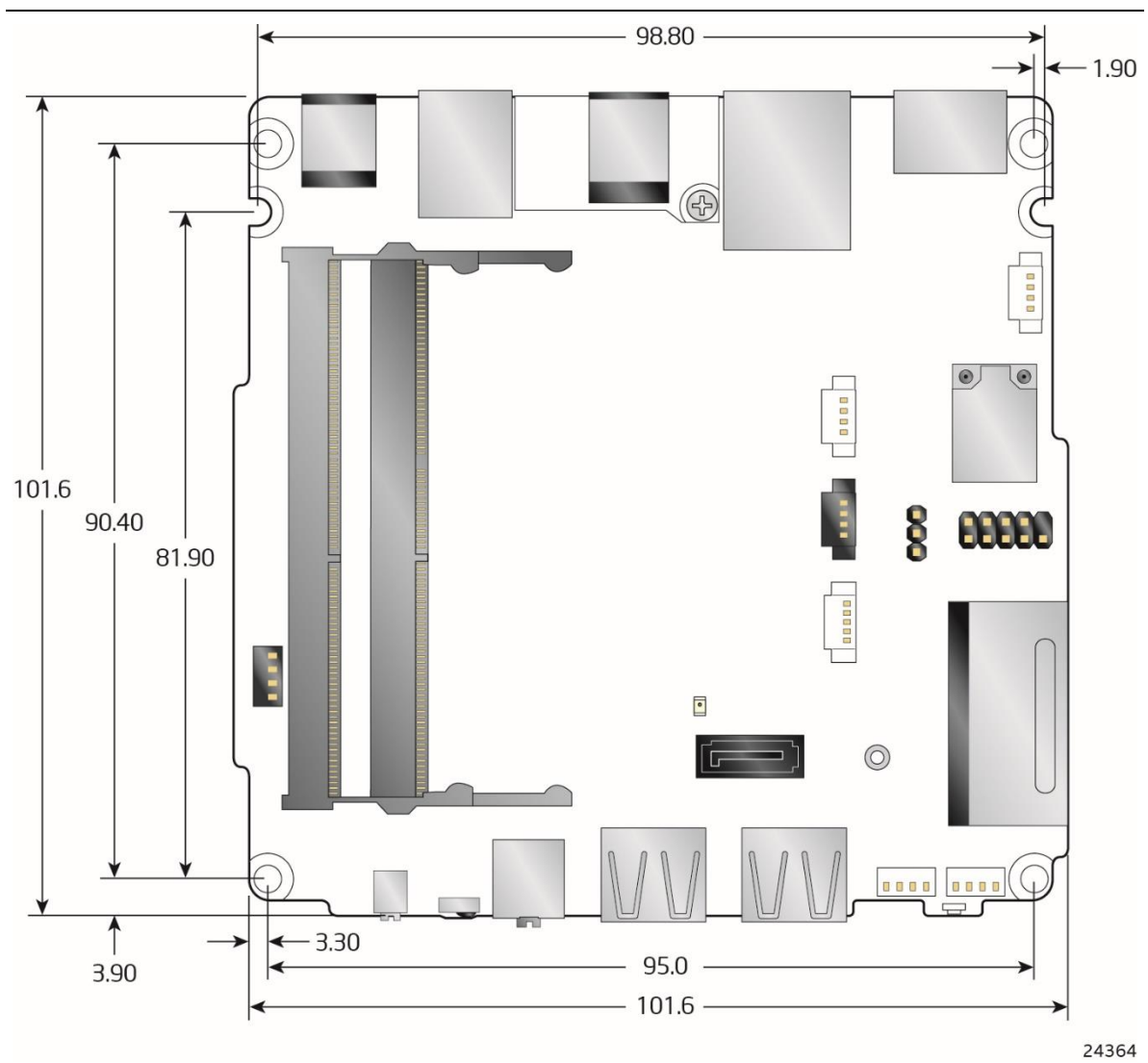

Figure 18. Board Dimensions

Figure 19 shows the height dimensions of the board.

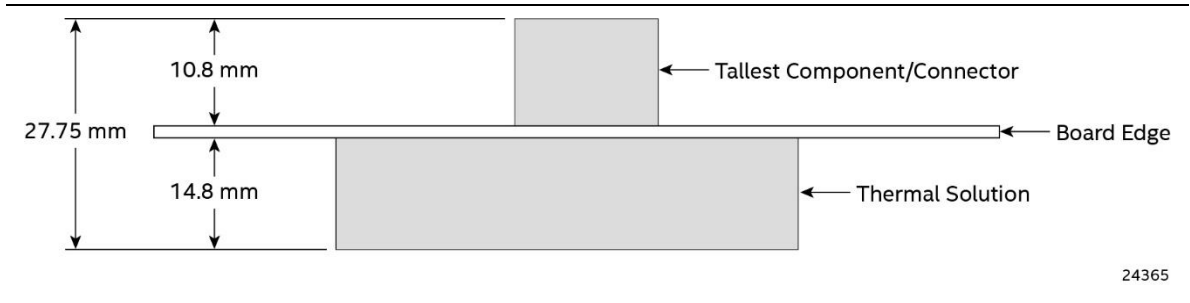

Figure 19. Board Height Dimensions

2.4.2 Weights

Table 25 lists select weights of boards and kits.

Table 25. Select Weights

Item	Weight (in kg)
Board with Thermal Solution	0.17
Tall Kit (includes Board Assembly)	0.53
Tall Mini PC (includes Board Assembly, memory, and drive)	0.65

2.5 Electrical Considerations

2.5.1 Power Supply Considerations

System power requirements will depend on actual system configurations chosen by the integrator, as well as end user expansion preferences. It is the system integrator’s responsibility to ensure an appropriate power budget for the system configuration is properly assessed based on the system-level components chosen.

2.5.2 Fan Header Current Capability

Table 26 lists the current capability of the fan header.

Table 26. Fan Header Current Capability

Fan Header	Maximum Available Current
Processor fan	.25 A

2.6 Thermal Considerations



CAUTION

A chassis with a maximum internal ambient temperature of 58 °C at the processor fan inlet is recommended. If the internal ambient temperature exceeds 58 °C, further thermal testing is required to ensure components do not exceed their maximum case temperature.



CAUTION

Failure to ensure appropriate airflow may result in reduced performance of both the processor and/or voltage regulator or, in some instances, damage to the board.

All responsibility for determining the adequacy of any thermal or system design remains solely with the system integrator. Intel makes no warranties or representations that merely following the instructions presented in this document will result in a system with adequate thermal performance.



CAUTION

Ensure that the ambient temperature does not exceed the board's maximum operating temperature. Failure to do so could cause components to exceed their maximum case temperature and malfunction. For information about the maximum operating temperature, see the environmental specifications in Section 2.8.



CAUTION

The processor voltage regulator area (shown in Figure 20) can reach a temperature of up to 97.5 °C in an open chassis. Ensure that proper airflow is maintained in the processor voltage regulator circuit. Failure to do so may result in shorter than expected product lifetime.

Figure 20 shows the locations of the localized high temperature zones.

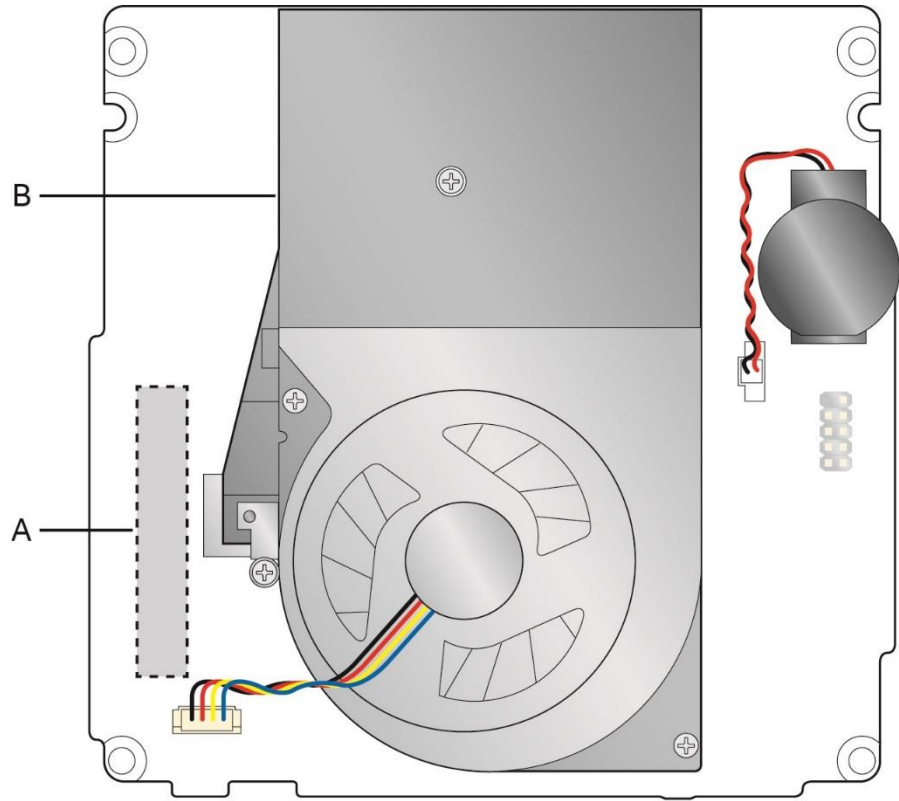

24366

Item	Description
A	Processor voltage regulator area
B	Thermal solution

Figure 20. Localized High Temperature Zones

Table 27 provides maximum case temperatures for the components that are sensitive to thermal changes. The operating temperature, current load, or operating frequency could affect case temperatures. Maximum case temperatures are important when considering proper airflow to cool the board.

Table 27. Thermal Considerations for Components

Component	Maximum Case Temperature
Processor	For processor case temperature, see processor datasheets and processor specification updates

To ensure functionality and reliability, the component is specified for proper operation when Case Temperature is maintained at or below the maximum temperature listed in Table 28. This is a requirement for sustained power dissipation equal to Thermal Design Power (TDP is specified as the maximum sustainable power to be dissipated by the components). When the component is dissipating less than TDP, the case temperature should be below the Maximum Case Temperature. The surface temperature at the geometric center of the component corresponds to Case Temperature.

It is important to note that the temperature measurement in the system BIOS is a value reported by embedded thermal sensors in the components and does not directly correspond to the Maximum Case Temperature. The upper operating limit when monitoring this thermal sensor is Tcontrol.

Table 28. Tcontrol Values for Components

Component	Tcontrol
Processor	For processor case temperature, see processor datasheets and processor specification updates

For information about	Refer to
Processor datasheets and specification updates	Section 1.2, page 17

2.7 Reliability

The Mean Time Between Failures (MTBF) prediction is calculated using component and subassembly random failure rates. The calculation is based on the Telcordia SR-332-2 Issue 2, Method I, Case 3, 55°C ambient. The MTBF prediction is used to estimate repair rates and spare parts requirements. The MTBF for the board is 68,196 hours.

2.8 Environmental

Table 29 lists the environmental specifications for the board.

Table 29. Environmental Specifications

Parameter	Specification	
Temperature		
Non-Operating	-40 °C to +60 °C	
Operating	0 °C to +50 °C The operating temperature of the board may be determined by measuring the air temperature from the junction of the heatsink fins and fan, next to the attachment screw, in a closed chassis, while the system is in operation.	
Shock		
Unpackaged	50 g trapezoidal waveform Velocity change of 170 inches/s ²	
Packaged	Free fall package drop machine set to the height determined by the weight of the package.	
	Product Weight (pounds)	Free Fall (inches)
	<20	36
	21-40	30
	41-80	24
	81-100	18
Vibration		
Unpackaged	5 Hz to 20 Hz: 0.01 g ² Hz sloping up to 0.02 g ² Hz 20 Hz to 500 Hz: 0.02 g ² Hz (flat)	
Packaged	5 Hz to 40 Hz: 0.015 g ² Hz (flat) 40 Hz to 500 Hz: 0.015 g ² Hz sloping down to 0.00015 g ² Hz	

Note: Before attempting to operate this board, the overall temperature of the board must be above the minimum operating temperature specified. It is recommended that the board temperature be at least room temperature before attempting to power on the board. The operating and non-operating environment must avoid condensing humidity.

3 Overview of BIOS Features

3.1 Introduction

The board uses an Intel Visual BIOS that is stored in the Serial Peripheral Interface Flash Memory (SPI Flash) and can be updated using a disk-based program. The SPI Flash contains the Visual BIOS Setup program, POST, the PCI auto-configuration utility, LAN EEPROM information, GOP (Graphics Output Protocol) video BIOS (VBIOS), and Plug and Play support. The initial production BIOSs are identified as JYGLKCPX.86A.

The Visual BIOS Setup program can be used to view and change the BIOS settings for the computer, and to update the system BIOS. The BIOS Setup program is accessed by pressing the [F2] key after the Power-On Self-Test (POST) memory test begins and before the operating system boot begins.



NOTE

The maintenance menu is displayed only when the board is in configuration mode. Section 2.3 on page 48 shows how to put the board in configuration mode.

3.2 BIOS Flash Memory Organization

The Serial Peripheral Interface Flash Memory (SPI Flash) includes a 128 Mb (16384 KB) flash memory device.

3.3 System Management BIOS (SMBIOS)

SMBIOS is a Desktop Management Interface (DMI) compliant method for managing computers in a managed network.

The main component of SMBIOS is the Management Information Format (MIF) database, which contains information about the computing system and its components. Using SMBIOS, a system administrator can obtain the system types, capabilities, operational status, and installation dates for system components. The MIF database defines the data and provides the method for accessing this information. The BIOS enables applications such as third-party management software to use SMBIOS. The BIOS stores and reports the following SMBIOS information:

- BIOS data, such as the BIOS revision level
- Fixed-system data, such as peripherals, serial numbers, and asset tags
- Resource data, such as memory size, cache size, and processor speed
- Dynamic data, such as event detection and error logging

Additional board information can be found in the BIOS under the second screen to the right of the Main BIOS page.

3.4 Legacy USB Support

Legacy USB is not supported on Intel NUC Products NUC7CJY/NUC7PJY.

3.5 BIOS Updates

The BIOS can be updated using either of the following utilities, which are available on the Intel World Wide Web site:

- Intel® Express BIOS Update utility, which enables automated updating while in the Windows environment. Using this utility, the BIOS can be updated from a file on a hard disk, a USB drive (a flash drive or a USB hard drive), or a USB CD-ROM.
- Intel [F7] switch during POST allows a user to select where the BIOS .bio file is located and perform the update from that location/device. Similar to performing a BIOS Recovery without removing the BIOS configuration jumper.
- Intel Visual BIOS allows the user to select the BIOS .bio file from a USB device or hard disk drive.

All utilities verify that the updated BIOS matches the target system to prevent accidentally installing an incompatible BIOS.



NOTE

Review the instructions distributed with the upgrade utility before attempting a BIOS update.

For information about

BIOS update utilities

Refer to

<http://www.intel.com/support/motherboards/desktop/sb/CS-034499.htm>

3.5.1 Language Support

The BIOS Setup program and help messages are supported in US English. Check the Intel web site for support.

3.6 BIOS Recovery

It is unlikely that anything will interrupt a BIOS update; however, if an interruption occurs, the BIOS could be damaged. Table 30 lists the drives and media types that can and cannot be used for BIOS recovery. The BIOS recovery media does not need to be made bootable.

Table 30. Acceptable Drives/Media Types for BIOS Recovery

Media Type ^(Note)	Can be used for BIOS recovery?
Hard disk drive (connected to SATA or USB)	Yes
CD/DVD drive (connected to USB)	Yes
USB flash drive	Yes
USB diskette drive (with a 1.4 MB diskette)	No (BIOS update file is bigger than 1.4 MB size limit)

**NOTE**

Supported file systems for BIOS recovery:

- NTFS (sparse, compressed, or encrypted files are not supported)
- FAT32
- FAT16
- FAT12
- ISO 9660

For information about**Refer to**

BIOS recovery

<http://www.intel.com/support/motherboards/desktop/sb/CS-034524.htm>

3.7 Boot Options

In the BIOS Setup program, the user can choose to boot from a hard drive, optical drive, removable drive, or the network. The default setting is for the optical drive to be the first boot device, the hard drive second, removable drive third, and the network fourth.

**NOTE**

Optical drives are not supported by the onboard SATA connectors. Optical drives are supported only via the USB interfaces.

3.7.1 Network Boot

The network can be selected as a boot device. This selection allows booting from the onboard LAN or a network add-in card with a remote boot ROM installed.

Pressing the [F12] key during POST automatically forces booting from the LAN. To use this key during POST, the User Access Level in the BIOS Setup program's Security menu must be set to Full.

3.7.2 Booting Without Attached Devices

For use in embedded applications, the BIOS has been designed so that after passing the POST, the operating system loader is invoked even if the following devices are not present:

- Video adapter
- Keyboard
- Mouse

3.7.3 Changing the Default Boot Device During POST

Pressing the [F10] key during POST causes a boot device menu to be displayed. This menu displays the list of available boot devices. Table 31 lists the boot device menu options.

Table 31. Boot Device Menu Options

Boot Device Menu Function Keys	Description
[↑] or [↓]	Selects a default boot device
[Enter]	Exits the menu, and boots from the selected device
[Esc]	Exits the menu and boots according to the boot priority defined through BIOS setup

3.7.4 Power Button Menu

The Power Button Menu is accessible via the following sequence:

1. System is in S4/S5 (not G3)
2. User pushes the power button and holds it down
3. The power LED will change to its secondary color to signal the user to release the power button (approximately 3 seconds); alternately, the system will emit three short beeps from the PC speaker or headphones, if installed, then stop. Release immediately.
4. User releases the power button before the 4-second shutdown override.

If this boot path is taken, the BIOS will use default settings, ignoring settings in VPD where possible.

The BIOS will display the following prompt and wait for a keystroke:

[ESC] Normal Boot
 [F2] Intel Visual BIOS
 [F3] Disable Fast Boot
 [F4] BIOS Recovery
 [F7] Update BIOS
 [F10] Enter Boot Menu
 [F12] Network Boot

[F3] Disable Fast Boot is only displayed if at least one Fast Boot optimization is enabled.

If an unrecognized key is hit, then the BIOS will beep and wait for another keystroke. If one of the listed hotkeys is hit, the BIOS will follow the indicated boot path. Password requirements must still be honored.

If Disable Fast Boot is selected, the BIOS will disable all Fast Boot optimizations and reset the system.

3.8 Hard Disk Drive Password Security Feature

The Hard Disk Drive Password Security feature blocks read and write accesses to the hard disk drive until the correct password is given. Hard Disk Drive Passwords are set in BIOS SETUP and are prompted for during BIOS POST. For convenient support of S3 resume, the system BIOS will automatically unlock drives on resume from S3. Valid password characters are A-Z, a-z, and 0-9. Passwords may be up to 19 characters in length.

The User hard disk drive password, when installed, will be required upon each power-cycle until the Master Key or User hard disk drive password is submitted.

The Master Key hard disk drive password, when installed, will not lock the drive. The Master Key hard disk drive password exists as an unlock override in the event that the User hard disk drive password is forgotten. Only the installation of the User hard disk drive password will cause a hard disk to be locked upon a system power-cycle.

Table 32 shows the effects of setting the Hard Disk Drive Passwords.

Table 32. Master Key and User Hard Drive Password Functions

Password Set	Password During Boot
Neither	None
Master only	None
User only	User only
Master and User Set	Master or User

During every POST, if a User hard disk drive password is set, POST execution will pause with the following prompt to force the user to enter the Master Key or User hard disk drive password:

Enter Hard Disk Drive Password:

Upon successful entry of the Master Key or User hard disk drive password, the system will continue with normal POST.

If the hard disk drive password is not correctly entered, the system will go back to the above prompt. The user will have three attempts to correctly enter the hard disk drive password. After the third unsuccessful hard disk drive password attempt, the system will halt with the message:

Hard Disk Drive Password Entry Error

A manual power cycle will be required to resume system operation.



NOTE

The passwords are stored on the hard disk drive so if the drive is relocated to another computer that does not support Hard Disk Drive Password Security feature, the drive will not be accessible.

3.9 BIOS Security Features

The BIOS includes security features that restrict access to the BIOS Setup program and who can boot the computer. A supervisor password and a user password can be set for the BIOS Setup program and for booting the computer, with the following restrictions:

- The supervisor password gives unrestricted access to view and change all the Setup options in the BIOS Setup program. This is the supervisor mode.
- The user password gives restricted access to view and change Setup options in the BIOS Setup program. This is the user mode.
- If only the supervisor password is set, pressing the <Enter> key at the password prompt of the BIOS Setup program allows the user restricted access to Setup.
- If both the supervisor and user passwords are set, users can enter either the supervisor password or the user password to access Setup. Users have access to Setup respective to which password is entered.
- Setting the user password restricts who can boot the computer. The password prompt will be displayed before the computer is booted. If only the supervisor password is set, the computer boots without asking for a password. If both passwords are set, the user can enter either password to boot the computer.
- For enhanced security, use different passwords for the supervisor and user passwords.
- Valid password characters are A-Z, a-z, and 0-9. Passwords may be up to 20 characters in length.
- To clear a set password, enter a blank password after entering the existing password.

Table 33 shows the effects of setting the supervisor password and user password. This table is for reference only and is not displayed on the screen.

Table 33. Supervisor and User Password Functions

Password Set	Supervisor Mode	User Mode	Setup Options	Password to Enter Setup	Password During Boot
Neither	Can change all options (Note)	Can change all options (Note)	None	None	None
Supervisor only	Can change all options	Can change a limited number of options	Supervisor Password	Supervisor	None
User only	N/A	Can change all options	Enter Password Clear User Password	User	User
Supervisor and user set	Can change all options	Can change a limited number of options	Supervisor Password Enter Password	Supervisor or user	Supervisor or user

Note: If no password is set, any user can change all Setup options.

4 Error Messages and Blink Codes

4.1 Front-panel Power LED Blink Codes

Whenever a recoverable error occurs during POST, the BIOS causes the board's front panel power LED to blink an error message describing the problem (see Table 34).

Table 34. Front-panel Power LED Blink Codes

Type	Pattern	Note
BIOS update in progress	Off when the update begins, then on for 0.5 seconds, then off for 0.5 seconds. The pattern repeats until the BIOS update is complete.	
Video error ^(Note)	On-off (1.0 second each) two times, then 2.5-second pause (off), entire pattern repeats (blink and pause) until the system is powered off.	When no video option ROM is found.
Memory error	On-off (1.0 second each) three times, then 2.5-second pause (off), entire pattern repeats (blinks and pause) until the system is powered off.	
Thermal trip warning	Each beep will be accompanied by the following blink pattern: .25 seconds on, .25 seconds off, .25 seconds on, .25 seconds off. This will result in a total of 16 blinks.	

Note: Disabled per default BIOS setup option.

4.2 BIOS Error Messages

Table 35 lists the error messages and provides a brief description of each.

Table 35. BIOS Error Messages

Error Message	Explanation
CMOS Battery Low	The battery may be losing power. Replace the battery soon.
CMOS Checksum Bad	The CMOS checksum is incorrect. CMOS memory may have been corrupted. Run Setup to reset values.
Memory Size Decreased	Memory size has decreased since the last boot. If no memory was removed, then memory may be bad.
No Boot Device Available	System did not find a device to boot.

5 Intel NUC Kit Features

5.1 Chassis Front Panel Features

Intel NUC Boards NUC7CJYB and NUC7PJYB can be found integrated into Intel® NUC Kit NUC7CJYH, Intel® NUC Kit NUC7PJYH, and Intel® NUC Mini PC NUC7CJYS. Figure 21 shows the location of the features located on or near the front of the chassis.

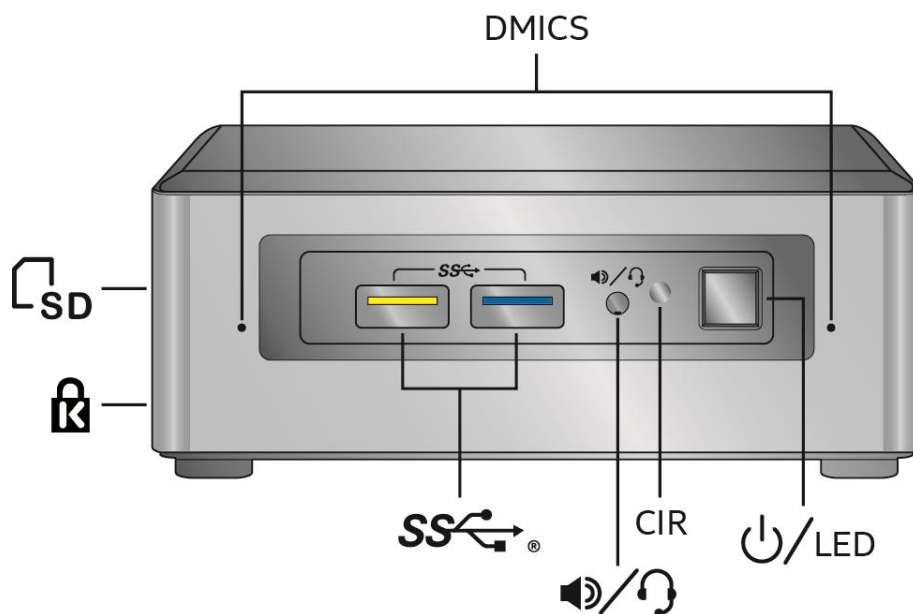







Figure 21. Intel NUC Products NUC7CJYH/NUC7PJYH/NUC7CJYS Features – Front

Table 36 lists the components identified in Figure 21.

Table 36. Components Shown in Figure 21

Item from Figure 21	Description
	Kensington* Anti-Theft Key Lock Hole
	SD Card Reader
DMICS	Digital Microphone Array
	Power Switch and Power LED
	Speaker/Headset Jack
	USB 3.0 Connectors
CIR	Consumer Infrared Sensor

5.2 Chassis Rear Panel Features

Figure 22 shows the location of the features located on the rear of the chassis.

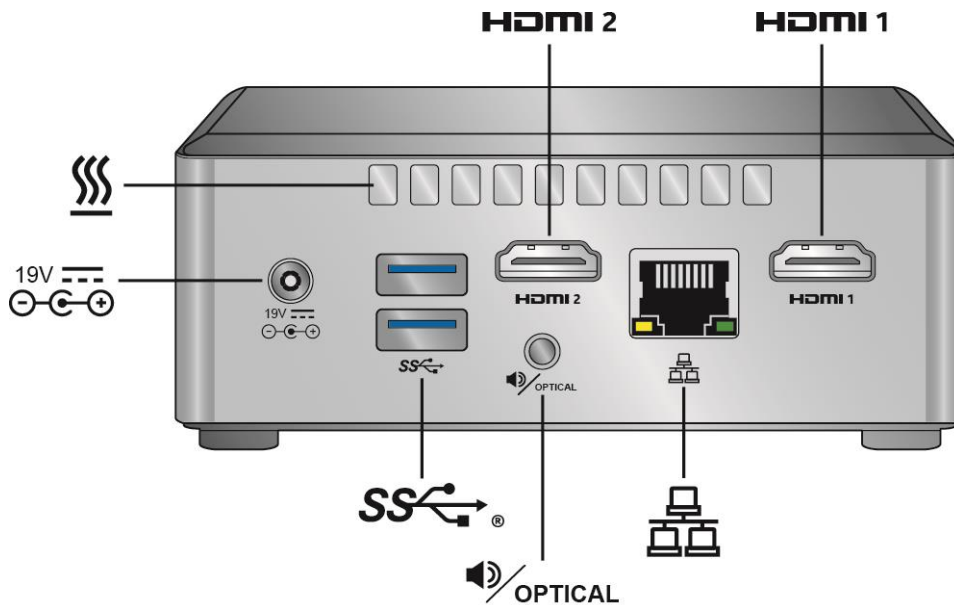

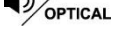



Figure 22. Intel NUC Products NUC7CJYH/NUC7PJYH/NUC7CJYS Features – Rear

Table 37 lists the components identified in Figure 22.

Table 37. Components Shown in Figure 22

Item from Figure 22	Description
 19V	19V DC Power Inlet
	Cooling Vents
	Speaker and Optical Audio Jack
HDMI	High Definition Multimedia Interface Connectors
	Ethernet Port
	USB 3.0 Connectors

Mouser Electronics

Authorized Distributor

Click to View Pricing, Inventory, Delivery & Lifecycle Information:

Intel:

[BOXNUC7PJYH1](#) [BOXNUC7CJYH1](#) [BOXNUC7CJYSAL1](#) [BOXNUC7PJYH2](#) [BOXNUC7CJYH2](#)
[BOXNUC7CJYSAL5](#) [BOXNUC7PJYH4](#) [BOXNUC7CJYH](#) [BOXNUC7PJYH](#) [BOXNUC7CJYSAL3](#) [BOXNUC7PJYH9](#)
[BOXNUC7PJYH5](#) [BOXNUC7PJYH3](#) [BOXNUC7CJYH5](#) [BOXNUC7CJYSAL2](#) [BOXNUC7CJYSAL4](#) [BOXNUC7CJYH4](#)
[BOXNUC7CJYH9](#) [BOXNUC7CJYSAL](#) [BOXNUC7CJYH3](#) [BLKNUC7CJYB](#) [BLKNUC7PJYB](#)



Компания «ЭлектроПласт» предлагает заключение долгосрочных отношений при поставках импортных электронных компонентов на взаимовыгодных условиях!

Наши преимущества:

- Оперативные поставки широкого спектра электронных компонентов отечественного и импортного производства напрямую от производителей и с крупнейших мировых складов;
- Поставка более 17-ти миллионов наименований электронных компонентов;
- Поставка сложных, дефицитных, либо снятых с производства позиций;
- Оперативные сроки поставки под заказ (от 5 рабочих дней);
- Экспресс доставка в любую точку России;
- Техническая поддержка проекта, помощь в подборе аналогов, поставка прототипов;
- Система менеджмента качества сертифицирована по Международному стандарту ISO 9001;
- Лицензия ФСБ на осуществление работ с использованием сведений, составляющих государственную тайну;
- Поставка специализированных компонентов (Xilinx, Altera, Analog Devices, Intersil, Interpoint, Microsemi, Aeroflex, Peregrine, Syfer, Eurofarad, Texas Instrument, Miteq, Cobham, E2V, MA-COM, Hittite, Mini-Circuits, General Dynamics и др.);

Помимо этого, одним из направлений компании «ЭлектроПласт» является направление «Источники питания». Мы предлагаем Вам помощь Конструкторского отдела:

- Подбор оптимального решения, техническое обоснование при выборе компонента;
- Подбор аналогов;
- Консультации по применению компонента;
- Поставка образцов и прототипов;
- Техническая поддержка проекта;
- Защита от снятия компонента с производства.



Как с нами связаться

Телефон: 8 (812) 309 58 32 (многоканальный)

Факс: 8 (812) 320-02-42

Электронная почта: org@eplast1.ru

Адрес: 198099, г. Санкт-Петербург, ул. Калинина, дом 2, корпус 4, литера А.