

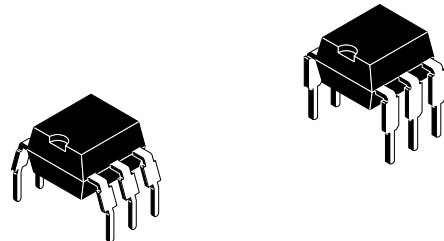

Optocoupler with Phototriac Output

Description

The K3010P(G) series consists of a phototransistor optically coupled to a gallium arsenide infrared-emitting diode in a 6-lead plastic dual in-line package. The elements are mounted on one leadframe using a **coplanar technique**, providing a fixed distance between input and output for highest safety requirements.



14827

Applications

Circuits for safe protective separation against electrical shock according to safety class II (reinforced isolation):

- For appl. class I – IV at mains voltage $\leq 300\text{ V}$
- For appl. class I – III at mains voltage $\leq 600\text{ V}$ according to VDE 0884, table 2, suitable for:

Monitors, air conditioners, line switches, solid state relays, microwaves.

VDE Standards

These couplers perform safety functions according to the following equipment standards:

- **VDE 0884**
Optocoupler for electrical safety requirements
- **IEC 950/EN 60950**
Office machines (applied for reinforced isolation for mains voltage $\leq 400\text{ V}_{\text{RMS}}$)
- **VDE 0804**
Telecommunication apparatus and data processing
- **IEC 65**
Safety for mains-operated electronic and related household apparatus

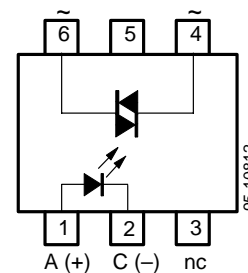

Note: Pin 5 must not be connected



Order Instruction

Ordering Code	CTR Ranking	Remarks
K3010P/ K3010PG ¹⁾	< 15 mA	
K3011P/ K3011PG ¹⁾	< 10 mA	
K3012P/ K3012PG ¹⁾	< 5 mA	

¹⁾ G = Leadform 10.16 mm; G is not marked on the body

Features

Approvals:

- **BSI:** BS EN 41003, BS EN 60095 (BS 415), BS EN 60950 (BS 7002), Certificate number 7081 and 7402
- **FIMKO (SETI):** EN 60950, Certificate number 12398
- **Underwriters Laboratory (UL)** 1577 recognized, file number E-76222
- **VDE 0884**, Certificate number 94778

VDE 0884 related features:

- Rated impulse voltage (transient overvoltage) $V_{IOTM} = 6 \text{ kV peak}$
- Isolation test voltage (partial discharge test voltage) $V_{pd} = 1.6 \text{ kV}$
- Rated isolation voltage (RMS includes DC) $V_{IOWM} = 600 V_{RMS} (848 \text{ V peak})$

- Rated recurring peak voltage (repetitive) $V_{IORM} = 600 V_{RMS}$
- Creepage current resistance according to VDE 0303/IEC 112
Comparative Tracking Index: CTI = 275
- Thickness through insulation $\geq 0.75 \text{ mm}$

General features:

- Isolation materials according to UL 94-VO
- Pollution degree 2 (DIN/VDE 0110 resp. IEC 664)
- Climatic classification 55/100/21 (IEC 68 part 1)
- Special construction:
Therefore, extra low coupling capacity of typical 0.2 pF, high **Common Mode Rejection**
- I_{FT} offered in 3 groups
- Coupling System C

Absolute Maximum Ratings

Input (Emitter)

Parameter	Test Conditions	Symbol	Value	Unit
Reverse voltage		V_R	5	V
Forward current		I_F	80	mA
Forward surge current	$t_p \leq 10 \mu\text{s}$	I_{FSM}	3	A
Power dissipation	$T_{amb} \leq 25^\circ\text{C}$	P_V	100	mW
Junction temperature		T_j	100	$^\circ\text{C}$

Output (Detector)

Parameter	Test Conditions	Symbol	Value	Unit
Off state output terminal voltage		V_{DRM}	250	V
On state RMS current		I_{TRMS}	100	mA
Peak surge current, non-repetitive	$t_p \leq 10 \text{ ms}$	I_{TMS}	1.5	A
Power dissipation	$T_{amb} \leq 25^\circ\text{C}$	P_V	300	mW
Junction temperature		T_j	100	$^\circ\text{C}$

Coupler

Parameter	Test Conditions	Symbol	Value	Unit
Isolation test voltage (RMS)	$t = 1 \text{ min}$	$V_{IO}^{1)}$	3.75	kV
Total power dissipation	$T_{amb} \leq 25^\circ\text{C}$	P_{tot}	350	mW
Ambient temperature range		T_{amb}	-40 to +85	$^\circ\text{C}$
Storage temperature range		T_{stg}	-55 to +100	$^\circ\text{C}$
Soldering temperature	2 mm from case, $t \leq 10 \text{ s}$	T_{sd}	260	$^\circ\text{C}$

¹⁾ Related to standard climate 23/50 DIN 50014

Electrical Characteristics ($T_{amb} = 25^{\circ}\text{C}$)

Input (Emitter)

Parameter	Test Conditions	Symbol	Min.	Typ.	Max.	Unit
Forward voltage	$I_F = 50 \text{ mA}$	V_F		1.25	1.6	V
Junction capacitance	$V_R = 0, f = 1 \text{ MHz}$	C_j		50		pF

Output (Detector)

Parameter	Test Conditions	Symbol	Min.	Typ.	Max.	Unit
Forward peak off-state voltage (repetitive)	$I_{DRM} = 100 \text{ nA}$	$V_{DRM}^{1)}$	250			V
Peak on-state voltage	$I_{TM} = 100 \text{ mA}$	V_{TM}		1.5	3	V
Critical rate of rise of off-state voltage	$I_{FT} = 0, I_{FT} = 30 \text{ mA}$	$(dv/dt)_{cr}$		10		$\text{V}/\mu\text{s}$
		$(dv/dt)_{crq}$	0.1	0.2		$\text{V}/\mu\text{s}$

¹⁾ Test voltage must be applied within dv/dt ratings

Coupler

Parameter	Test Conditions	Type	Symbol	Min.	Typ.	Max.	Unit
Emitting diode trigger current	$V_S = 3 \text{ V}, R_L = 150 \Omega$	K3010P(G)	I_{FT}		8	15	mA
		K3011P(G)	I_{FT}		5	10	mA
		K3012P(G)	I_{FT}		2	5	mA
Holding current	$I_F = 10 \text{ mA}, V_S \geq 3 \text{ V}$		I_H		100		μA

Note: I_{FT} is defined as a minimum trigger current



Test condition:
 dv/dt_{cr}
 $V_S = 2/3 V_{DRM}$
 (Sine wave)
 $R_L = 33 \text{ k}\Omega$
 dv/dt_{crq}
 $V_{eff} = 30 \text{ V}$
 (Sine wave)
 $R_L = 2 \text{ k}\Omega$

Figure 1. Test circuit for dv/dt_{cr} and dv/dt_{crq}



- dv/dt_{cr} Highest value of the "rate of rise of off-state voltage" which does not cause any switching from the off-state to the on-state
- dv/dt_{crq} Highest value of the "rate of rise of communicating voltage" which does not switch on the device again, after the voltage has decreased to zero and the trigger current is switched from I_{FT} to zero

Figure 2.



Figure 3. Motor control circuit



Maximum Safety Ratings (according to VDE 0884) see figure 4

This device is used for protective separation against electrical shock only within the maximum safety ratings. This must be ensured by using protective circuits in the applications.

Input (Emitter)

Parameters	Test Conditions	Symbol	Value	Unit
Forward current		I_{si}	130	mA

Output (Detector)

Parameters	Test Conditions	Symbol	Value	Unit
Power dissipation	$T_{amb} \leq 25^\circ\text{C}$	P_{si}	600	mW

Coupler

Parameters	Test Conditions	Symbol	Value	Unit
Rated impulse voltage		$V_{IO\overline{TM}}$	6	kV
Safety temperature		T_{si}	150	$^\circ\text{C}$

Insulation Rated Parameters (according to VDE 0884)

Parameter	Test Conditions	Symbol	Min.	Typ.	Max.	Unit
Partial discharge test voltage – Routine test	100%, $t_{test} = 1\text{ s}$	V_{pd}	1.6			kV
		$V_{IO\overline{TM}}$	6			kV
Partial discharge test voltage – Lot test (sample test)	$t_{Tr} = 60\text{ s}$, $t_{test} = 10\text{ s}$, (see figure 5)	V_{pd}	1.3			kV
Insulation resistance	$V_{IO} = 500\text{ V}$	R_{IO}	10^{12}			Ω
	$V_{IO} = 500\text{ V}$, $T_{amb} = 100^\circ\text{C}$	R_{IO}	10^{11}			Ω
	$V_{IO} = 500\text{ V}$, $T_{amb} = 150^\circ\text{C}$ (construction test only)	R_{IO}	10^9			Ω



Figure 4. Derating diagram

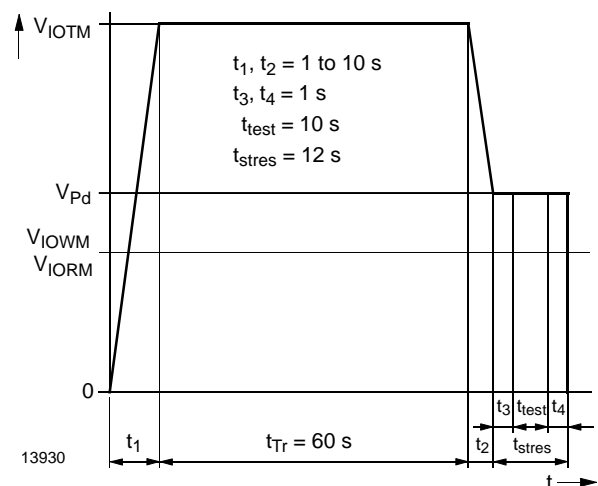

Figure 5. Test pulse diagram for sample test according to DIN VDE 0884

Typical Characteristics ($T_{amb} = 25^{\circ}\text{C}$, unless otherwise specified)

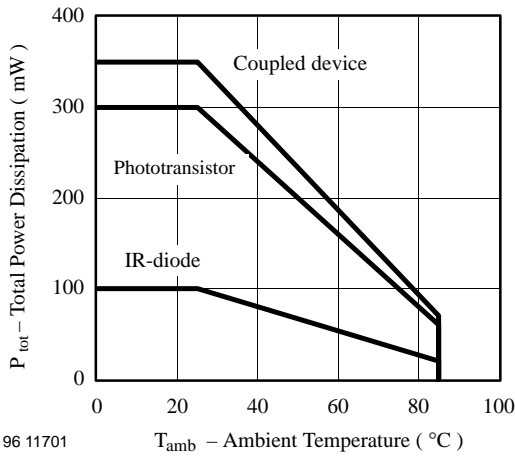

Figure 6. Total Power Dissipation vs. Ambient Temperature

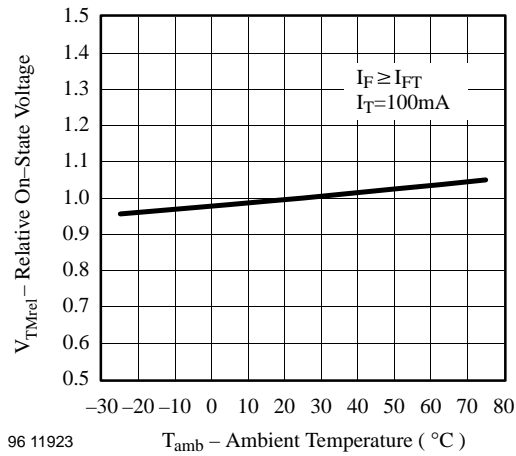

Figure 9. Relative On - State vs. Ambient Temperature

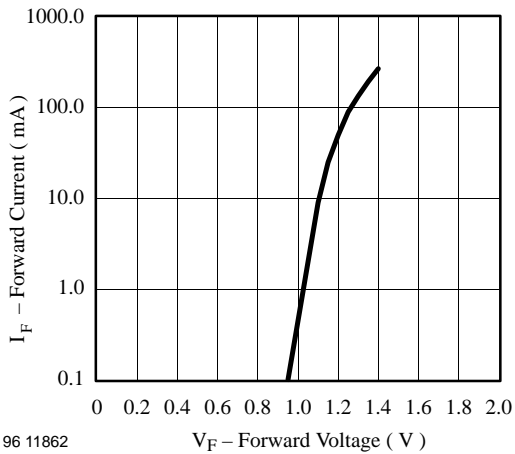

Figure 7. Forward Current vs. Forward Voltage

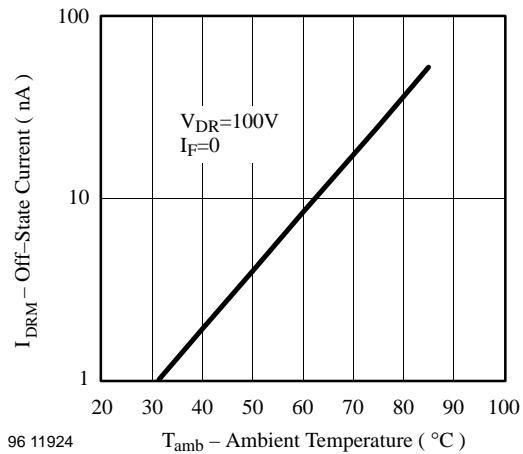

Figure 10. Off - State Current vs. Ambient Temperature

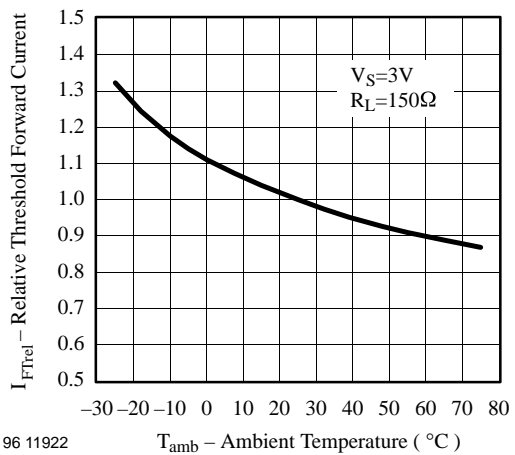

Figure 8. Relative Threshold Forward Current vs. Ambient Temperature

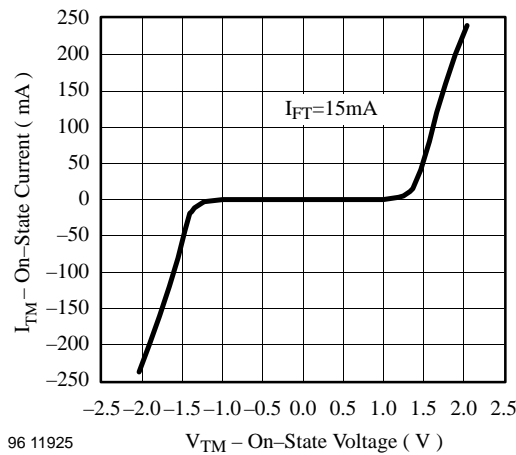

Figure 11. On - State Current vs. Ambient Temperature



Figure 12. Marking example

Dimensions of K301.PG in mm



weight : ca 0.50g
 creepage distance : > 8mm
 air path : > 8mm
 after mounting on PC board



technical drawings according to DIN specifications

14771

K3010P(G) Series

Vishay Telefunken



Dimensions of K301.P in mm





Ozone Depleting Substances Policy Statement

It is the policy of **Vishay Semiconductor GmbH** to

1. Meet all present and future national and international statutory requirements.
2. Regularly and continuously improve the performance of our products, processes, distribution and operating systems with respect to their impact on the health and safety of our employees and the public, as well as their impact on the environment.

It is particular concern to control or eliminate releases of those substances into the atmosphere which are known as ozone depleting substances (ODSs).

The Montreal Protocol (1987) and its London Amendments (1990) intend to severely restrict the use of ODSs and forbid their use within the next ten years. Various national and international initiatives are pressing for an earlier ban on these substances.

Vishay Semiconductor GmbH has been able to use its policy of continuous improvements to eliminate the use of ODSs listed in the following documents.

1. Annex A, B and list of transitional substances of the Montreal Protocol and the London Amendments respectively
2. Class I and II ozone depleting substances in the Clean Air Act Amendments of 1990 by the Environmental Protection Agency (EPA) in the USA
3. Council Decision 88/540/EEC and 91/690/EEC Annex A, B and C (transitional substances) respectively.

Vishay Semiconductor GmbH can certify that our semiconductors are not manufactured with ozone depleting substances and do not contain such substances.

We reserve the right to make changes to improve technical design and may do so without further notice.

Parameters can vary in different applications. All operating parameters must be validated for each customer application by the customer. Should the buyer use Vishay Telefunken products for any unintended or unauthorized application, the buyer shall indemnify Vishay Telefunken against all claims, costs, damages, and expenses, arising out of, directly or indirectly, any claim of personal damage, injury or death associated with such unintended or unauthorized use.

Vishay Semiconductor GmbH, P.O.B. 3535, D-74025 Heilbronn, Germany
Telephone: 49 (0) 7131 67 2831, Fax number: 49 (0) 7131 67 2423



Компания «ЭлектроПласт» предлагает заключение долгосрочных отношений при поставках импортных электронных компонентов на взаимовыгодных условиях!

Наши преимущества:

- Оперативные поставки широкого спектра электронных компонентов отечественного и импортного производства напрямую от производителей и с крупнейших мировых складов;
- Поставка более 17-ти миллионов наименований электронных компонентов;
- Поставка сложных, дефицитных, либо снятых с производства позиций;
- Оперативные сроки поставки под заказ (от 5 рабочих дней);
- Экспресс доставка в любую точку России;
- Техническая поддержка проекта, помощь в подборе аналогов, поставка прототипов;
- Система менеджмента качества сертифицирована по Международному стандарту ISO 9001;
- Лицензия ФСБ на осуществление работ с использованием сведений, составляющих государственную тайну;
- Поставка специализированных компонентов (Xilinx, Altera, Analog Devices, Intersil, Interpoint, Microsemi, Aeroflex, Peregrine, Syfer, Eurofarad, Texas Instrument, Miteq, Cobham, E2V, MA-COM, Hittite, Mini-Circuits, General Dynamics и др.);

Помимо этого, одним из направлений компании «ЭлектроПласт» является направление «Источники питания». Мы предлагаем Вам помощь Конструкторского отдела:

- Подбор оптимального решения, техническое обоснование при выборе компонента;
- Подбор аналогов;
- Консультации по применению компонента;
- Поставка образцов и прототипов;
- Техническая поддержка проекта;
- Защита от снятия компонента с производства.



Как с нами связаться

Телефон: 8 (812) 309 58 32 (многоканальный)

Факс: 8 (812) 320-02-42

Электронная почта: org@eplast1.ru

Адрес: 198099, г. Санкт-Петербург, ул. Калинина, дом 2, корпус 4, литера А.