

General Specifications

Electrical Capacity (Resistive Load)

Power Level (silver):	6A @ 125V AC & 3A @ 250V AC or 3A @ 30V DC
Logic Level (gold):	0.4VA maximum @ 28V AC/DC maximum (Applicable Range 0.1mA ~ 0.1A @ 20mV ~ 28V)
Logic/Power Level: (gold over silver)	Combines silver & gold ratings

Note: Find additional explanation dual rating & operating range in Supplement section.

Other Ratings

Contact Resistance:	10 milliohms maximum for silver; 20 milliohms maximum for gold
Insulation Resistance:	1,000 megohms minimum @ 500V DC
Dielectric Strength:	1,000V AC minimum between contacts for 1 minute minimum; 1,500V AC minimum between contacts & case for 1 minute minimum
Mechanical Life:	50,000 operations minimum for splashproof models; 100,000 for all other models
Electrical Life:	25,000 operations minimum for silver; 50,000 operations minimum for gold 50,000 operations minimum for silver at 3A @ 125V AC

Nominal Operating Force: Momentary Action: 1-pole 9.32N; 2-pole 16.18N; 4-pole 25.54N;
Alternate Action: 1-pole 4.41N; 2-pole 7.06N; 4-pole 11.77N

Contact Timing:	Slow make, slow break		
Plunger Travel:	Screw-on Cap (Mom.)	Screw-on Cap (Alt.)	Snap-on Cap (Mom. & Alt.)
Pretravel:	.028" (0.71mm)	.110" (2.80mm)	.125" (3.19mm)
Overtravel:	.043" (1.09mm)	.043" (1.10mm)	.050" (1.26mm)
Total Travel	.071" (1.80mm)	.153" (3.90mm)	.175" (4.45mm)

Materials & Finishes

Plunger:	Brass w/nickel plating; polyacetal w/B1 bushing	Bushing:	Brass with nickel plating
Frame:	Stainless steel	Case:	Diallyl phthalate resin (UL94V-0)
Movable Contactor:	Phosphor bronze with silver or gold plating		
Movable Contacts:	Silver alloy (code W); copper with gold plating (code G); or silver alloy with gold plating (code A)		
Stationary Contacts:	Silver with silver plating (code W); copper or brass with gold plating (code G); or silver with gold plating (code A)		
Terminals:	Copper or brass with silver plating; copper or brass with gold plating		

Environmental Data

Operating Temp Range:	-30°C through +85°C (-22°F through +185°F)
Humidity:	90 ~ 95% humidity for 96 hours @ 40°C (104°F)
Vibration:	10 ~ 55Hz with peak-to-peak amplitude of 1.5mm traversing the frequency range & returning in 1 minute; 3 right angled directions for 2 hours
Shock:	50G (490m/s ²) acceleration (tested in 6 right angled directions, with 5 shocks in each direction)
Sealing:	B3 & D3 bushing options equivalent to IP67

Installation

Mounting Torque:	1.5Nm (13.0 lb•in) for double nut; .7Nm (6.0 lb•in) for single nut
Cap Installation Force:	80.0N (18.0 lbf) maximum downward force on actuator
Soldering Time & Temp:	Wave Soldering (PC version): See Profile A in Supplement section. Manual Soldering: See Profile A in Supplement section.
Process Seal:	These devices are not process sealed. Hand clean locally using alcohol based solution.

Standards & Certifications

Flammability Standards:	UL94V-0 case
UL:	File No. E44145 - Recognized only when ordered with marking on switch. Add "/U" or "/CUL" before dash in part number to order UL recognized switch. All models recognized at 6A @ 125V AC or 3A @ 250V AC or 0.4VA max. @ 28V DC max.
CSA:	File No. 023535_0_000 - Certified only when ordered with marking on switch. Add "/C" before dash in part number to order CSA certified switch. All models certified at 6A @ 125V AC or 3A @ 250V AC or 0.4VA max. @ 28V max.

Distinctive Characteristics

Guide interlocked with actuator block prevents window locking and maintains correct plunger alignment to assure contact stability.

Employs an over-center actuator mechanism, which diminishes sparking and increases operating life in AC circuits.

High torque bushing construction prevents rotation or separation from frame during installation.

Splashproof option (D3 and B3 bushing codes) features an o-ring within the bushing and one under the face nut to protect from splashed, sprayed, or spilled liquids.

High insulating barriers, formed in the molded diallyl phthalate case, increase isolation of circuits in multipole devices.

Prominent external insulating barriers increase insulation resistance and dielectric strength.



Epoxy sealed terminals prevent entry of solder flux and other contaminants.

Clinching of the frame to the case well above the base and terminals provides 1,500V dielectric strength.



Actual Size



	Bushing Mount	Page C74
	Bracket PC Mount	Page C80
	Large Bushing	Page C87

- Toggle
- Rockers
- Pushbuttons**
- Illuminated PB
- Programmable
- Keylocks
- Rotaries
- Slides
- Tactiles
- Tilt
- Touch
- Indicators
- Accessories
- Supplement

TYPICAL SWITCH ORDERING EXAMPLE

MB

2011

S

S2

G

13

C

A

Poles & Circuits

2011	SPDT	ON	(ON)
2065	SPDT	ON	ON
2061	DPDT	ON	(ON)
2085	DPDT	ON	ON
2181	4PDT	ON	(ON)
2185	4PDT	ON	ON

() = Momentary

4-pole not for use with right angle terminals

Contact Materials & Ratings

W	Silver Rated 6A @ 125V AC & 3A @ 250V AC
G	Gold Rated 0.4VA max @ 28V AC/DC max
A	Gold over Silver Rated 6A @ 125V AC & 0.4VA max @ 28V AC/DC max

Caps

B	.315" (8.0mm) Diameter
C	.394" (10.0mm) Diameter

Cap Colors

A	Black
B	White
C	Red
E	Yellow
F	Green
G	Blue
H	Gray

Plunger Type

S	Plunger for Screw-on Caps
----------	---------------------------

Bushings

S2	.335" (8.5mm) Smooth with Keyway
S1	.335" (8.5mm) Threaded with Keyway
A2	.200" (5.08mm) Smooth with Keyway Only Available in Part Numbers MB2011SA2G31 & MB2011SA2W31

Terminals

13	.250" (6.35mm) Straight PC with Bracket
40	.150" (3.81mm) Vertical PC
45	.100" (2.54mm) Vertical PC
30	Right Angle PC with .646" (16.4mm) Support to Terminals Available in 1- & 2-pole only
31	Right Angle PC with .500" (12.7mm) Support to Terminals Available in 1-pole only

IMPORTANT:

Switches are supplied without UL, cULus & CSA marking unless specified. **UL, cULus & CSA recognized only when ordered with marking on the switch.** Specific models, ratings, & ordering instructions are noted on General Specifications page.







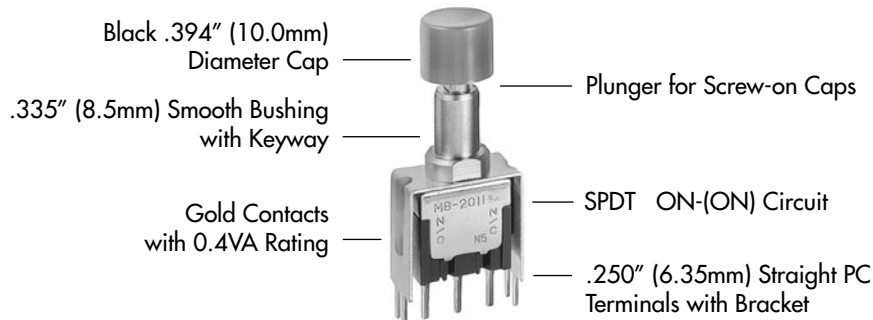









DESCRIPTION FOR TYPICAL ORDERING EXAMPLE

MB2011SS2G13-CA

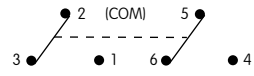

POLES & CIRCUITS

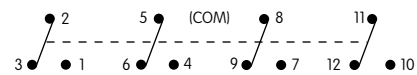
Pole	Model	Plunger Position () = Momentary		Connected Terminals		Throw & Switch Schematics
		Normal 	Down 	Normal 	Down 	
SP	MB2011 MB2065	ON 	(ON) ON	2-3 	2-1 	SPDT Note: Terminal numbers are not actually on the switch. 
DP	MB2061 MB2085	ON 	(ON) ON	2-3 5-6 	2-1 5-4 	DPDT 
4P	MB2181 MB2185	ON 	(ON) ON	2-3 5-6 8-9 11-12 	2-1 5-4 8-7 11-10 	4PDT 

PLUNGER TYPE

On alternate action models, after transferring circuit, the plunger returns to its original position and does not latch down.

S

Plunger for Screw-on Caps

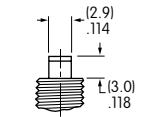

Momentary Plunger Length

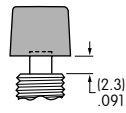

Momentary Cap Location

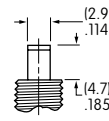

Alternate Plunger Length

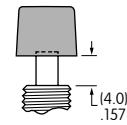

Alternate Cap Location

BUSHINGS

S2

.335" (8.5mm)
Smooth with Keyway

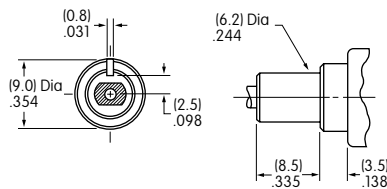

S1

.335" (8.5mm)
Threaded with Keyway

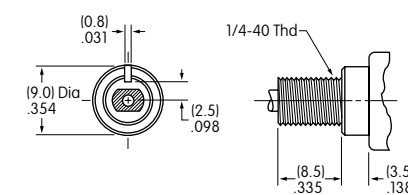

A2

.200" (5.08mm)
Smooth with Keyway

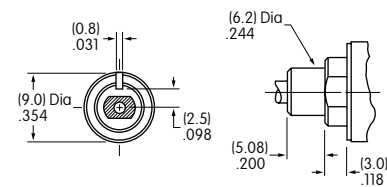

Standard hardware: 2 hex nuts (AT513H)
& 1 lockwasher (AT509)
Optional hardware: Locking ring (AT507)

Only available in part numbers
MB2011SA2W31 & MB2011SA2G31

Panel Cutouts

For S2, S1, or A2 Bushing
with Keyway

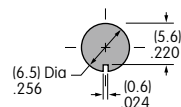

With Optional
Locking Ring

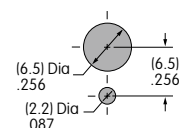

Maximum Panel Thickness with
Standard Hardware: .154" (3.9mm)

CONTACT MATERIALS & RATINGS

W	Silver over Silver	Power Level	6A @ 125V AC & 3A @ 250V AC
G	Gold over Brass or Copper	Logic Level	0.4VA maximum @ 28V AC/DC maximum Note: Complete explanation of operating range in Supplement section.
A	Gold over Silver	Power Level or Logic Level	6A @ 125V AC & 3A @ 250V AC or 0.4VA maximum @ 28V AC/DC maximum Note: This dual rated option is suitable when two or more identical switches are used in logic and in power circuits within the same application. See Supplement section for complete explanation of dual rating and operating range.

TERMINALS

13 .250" (6.35mm) Straight PC with Bracket

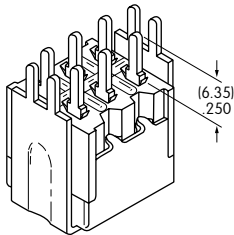

40 .150" (3.81mm) Vertical PC

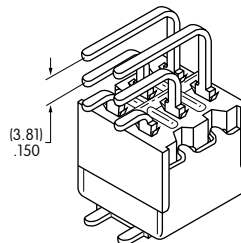

45 .100" (2.54mm) Vertical PC

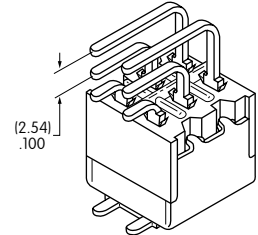

30 Right Angle PC with .646" (16.4mm) Support to Terminal

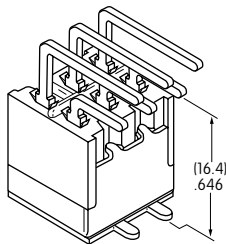

Only Available in 1 & 2 Pole

31 Right Angle PC with .500" (12.7mm) Support to Terminal

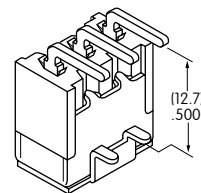

Note: Full dimensioned drawings appear on the following pages.

CAPS & CAP COLORS

B AT413
.315" (8.0mm) Diameter
Screw-on Cap

Cap Material: PBT
Finish: Glossy



C AT407
.394" (10.0mm) Diameter
Screw-on Cap

Cap Material: PBT
Finish: Glossy

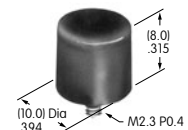

Cap Colors Available: **A** Black **B** White **C** Red **E** Yellow **F** Green **G** Blue **H** Gray

TYPICAL SWITCH DIMENSIONS

Single Pole

Straight PC with Bracket

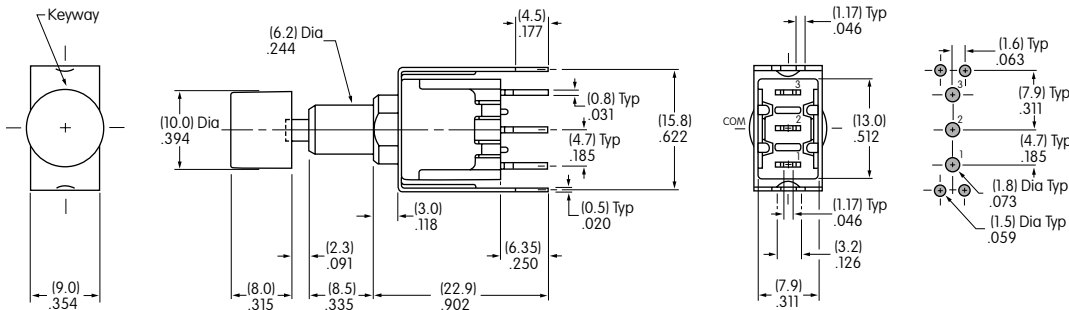

MB2011SS2G13-CA

Double Pole

Straight PC with Bracket

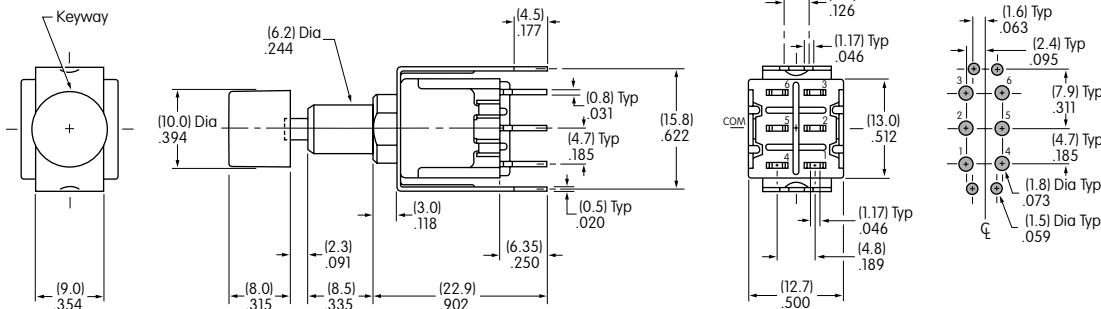

MB2061SS2G13-CA

Four Pole

Straight PC with Bracket

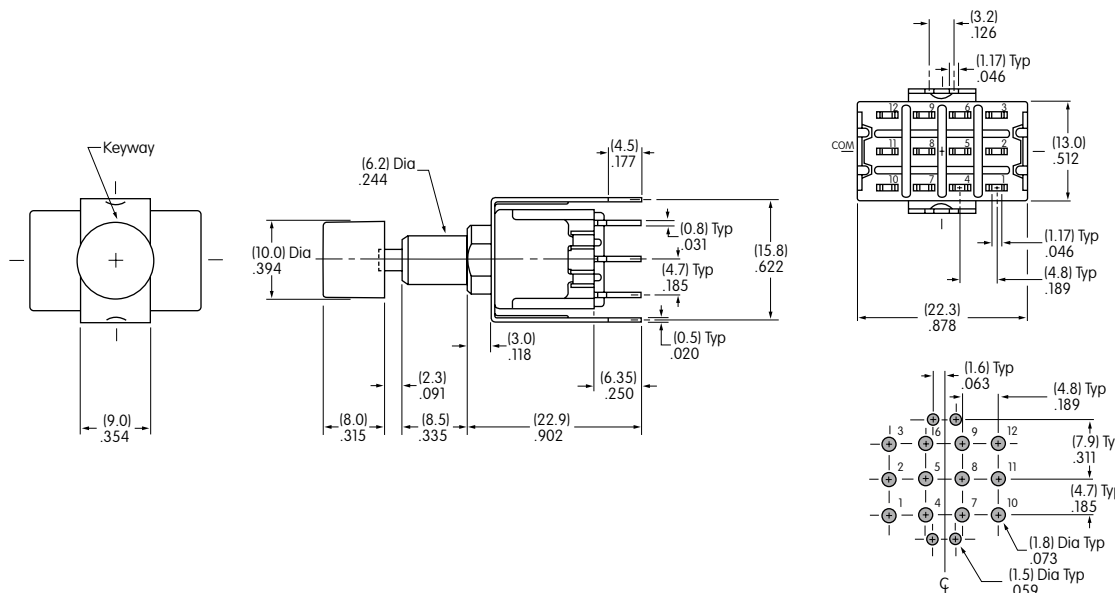

MB2181SS2G13-CA

TYPICAL SWITCH DIMENSIONS

.150" (3.81mm) Vertical PC

Single Pole

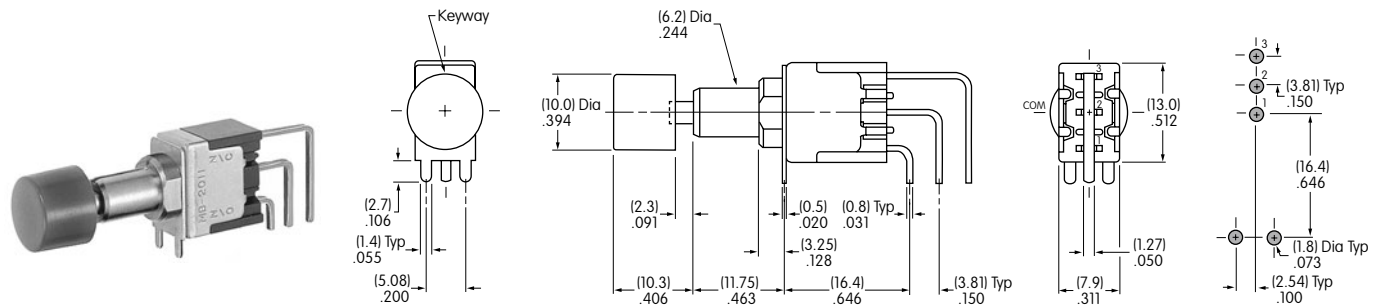

MB2011SS2G40-CA

.150" (3.81mm) Vertical PC

Double Pole

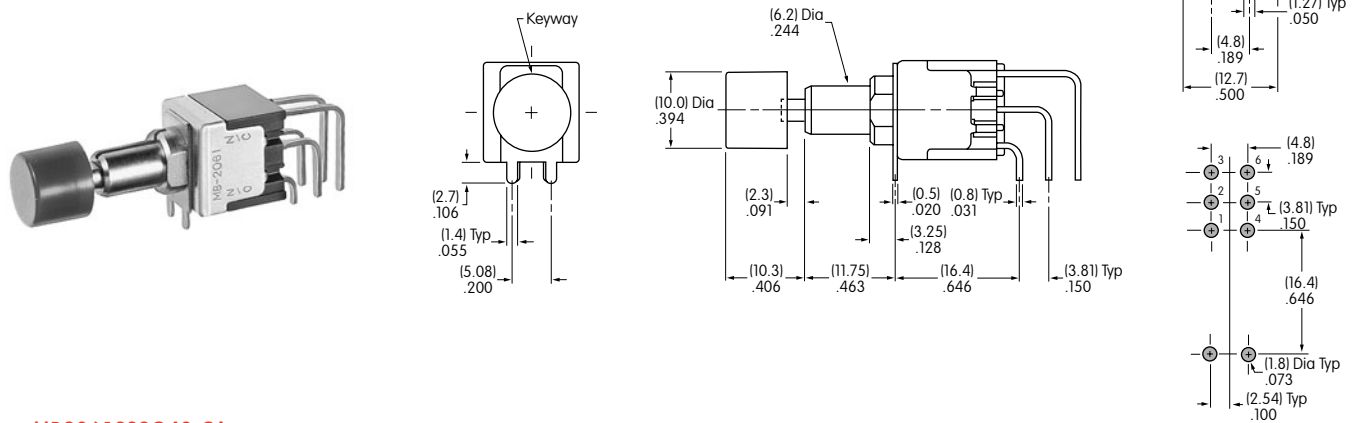

MB2061SS2G40-CA

.150" (3.81mm) Vertical PC

Four Pole

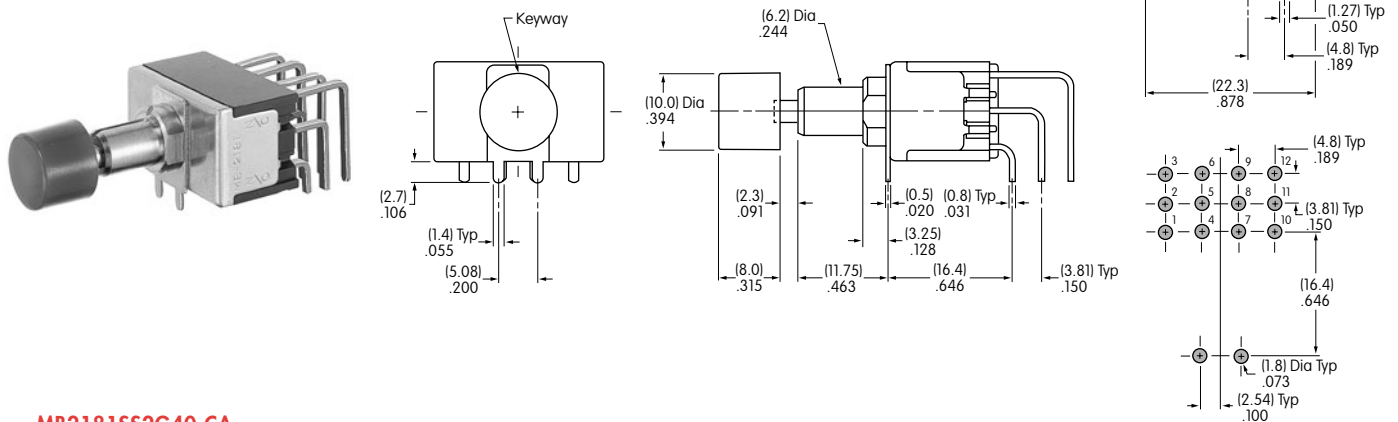

MB2181SS2G40-CA

TYPICAL SWITCH DIMENSIONS

Single Pole

.100" (2.54mm) Vertical PC

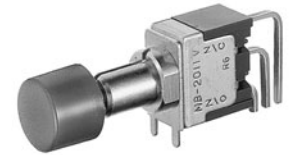
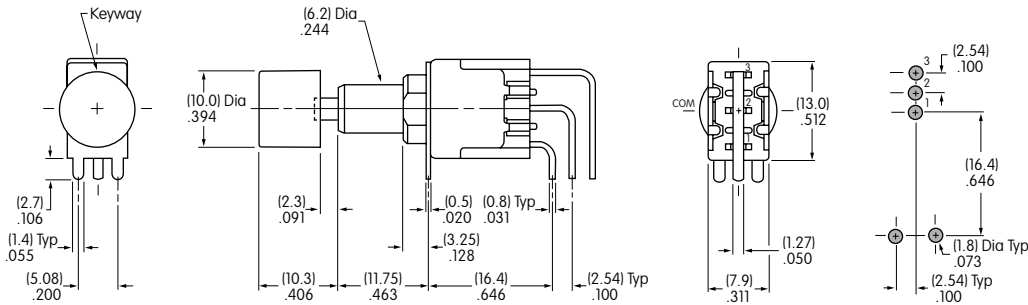

MB2011SS2G45-CA

Double Pole

.100" (2.54mm) Vertical PC

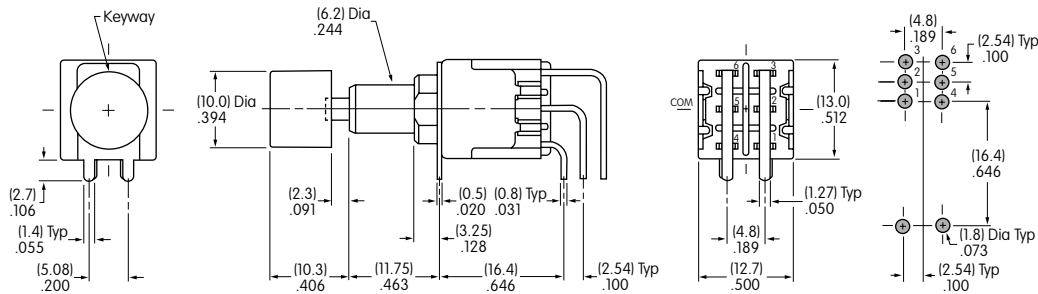

MB2061SS2G45-CA

Four Pole

.100" (2.54mm) Vertical PC

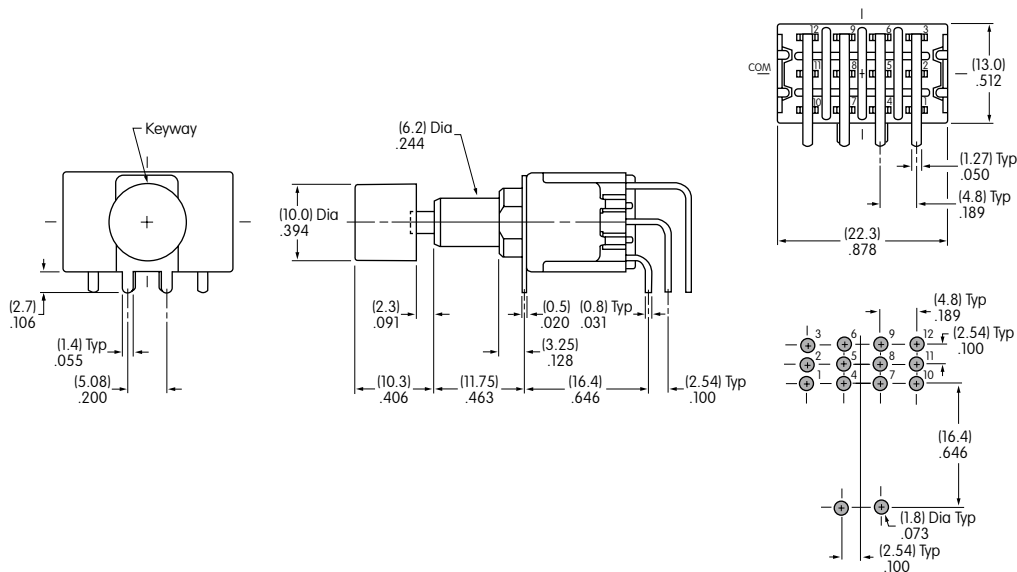

MB2181SS2G45-CA

TYPICAL SWITCH DIMENSIONS

Right Angle PC

Single Pole

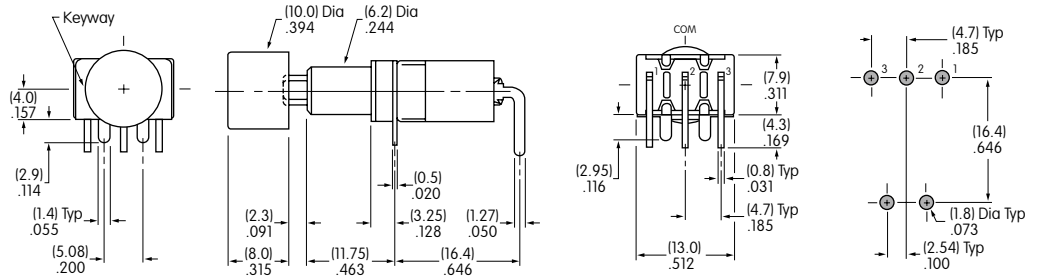

MB2011SS2G30-CA

Right Angle PC

Double Pole

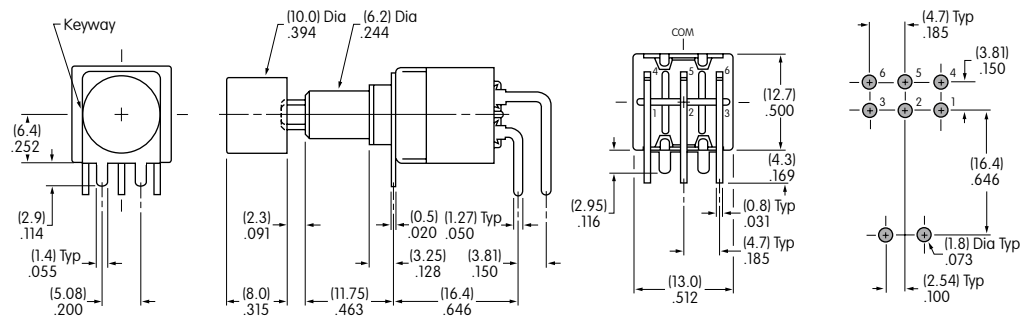

MB2061SS2G30-CA

Right Angle PC with .500" (12.7mm) Support to Terminal

Single Pole

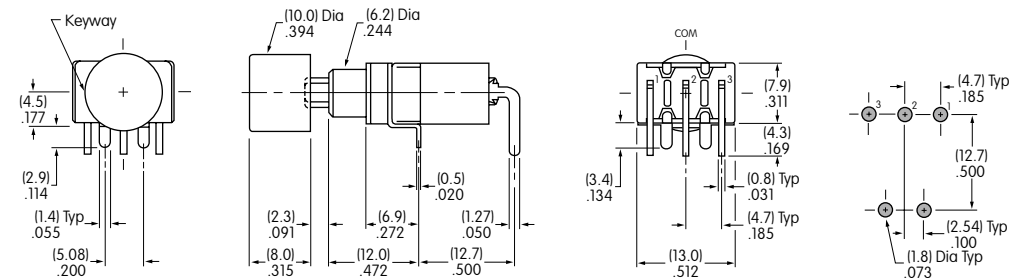

MB2011SA2G31-CA



Компания «ЭлектроПласт» предлагает заключение долгосрочных отношений при поставках импортных электронных компонентов на взаимовыгодных условиях!

Наши преимущества:

- Оперативные поставки широкого спектра электронных компонентов отечественного и импортного производства напрямую от производителей и с крупнейших мировых складов;
- Поставка более 17-ти миллионов наименований электронных компонентов;
- Поставка сложных, дефицитных, либо снятых с производства позиций;
- Оперативные сроки поставки под заказ (от 5 рабочих дней);
- Экспресс доставка в любую точку России;
- Техническая поддержка проекта, помощь в подборе аналогов, поставка прототипов;
- Система менеджмента качества сертифицирована по Международному стандарту ISO 9001;
- Лицензия ФСБ на осуществление работ с использованием сведений, составляющих государственную тайну;
- Поставка специализированных компонентов (Xilinx, Altera, Analog Devices, Intersil, Interpoint, Microsemi, Aeroflex, Peregrine, Syfer, Eurofarad, Texas Instrument, Miteq, Cobham, E2V, MA-COM, Hittite, Mini-Circuits, General Dynamics и др.);

Помимо этого, одним из направлений компании «ЭлектроПласт» является направление «Источники питания». Мы предлагаем Вам помощь Конструкторского отдела:

- Подбор оптимального решения, техническое обоснование при выборе компонента;
- Подбор аналогов;
- Консультации по применению компонента;
- Поставка образцов и прототипов;
- Техническая поддержка проекта;
- Защита от снятия компонента с производства.



Как с нами связаться

Телефон: 8 (812) 309 58 32 (многоканальный)

Факс: 8 (812) 320-02-42

Электронная почта: org@eplast1.ru

Адрес: 198099, г. Санкт-Петербург, ул. Калинина, дом 2, корпус 4, литера А.