

# General Specifications

## Electrical Capacity (Resistive Load)

<b>Power Level (silver):</b>	6A @ 125V AC & 3A @ 250V AC or 3A @ 30V DC
<b>Logic Level (gold):</b>	0.4VA maximum @ 28V AC/DC maximum (Applicable Range 0.1mA ~ 0.1A @ 20mV ~ 28V)
<b>Logic/Power Level: (gold over silver)</b>	Combines silver & gold ratings

Note: Find additional explanation dual rating & operating range in Supplement section.

## Other Ratings

<b>Contact Resistance:</b>	10 milliohms maximum for silver; 20 milliohms maximum for gold
<b>Insulation Resistance:</b>	1,000 megohms minimum @ 500V DC
<b>Dielectric Strength:</b>	1,000V AC minimum between contacts for 1 minute minimum; 1,500V AC minimum between contacts & case for 1 minute minimum
<b>Mechanical Life:</b>	50,000 operations minimum for splashproof models; 100,000 for all other models
<b>Electrical Life:</b>	25,000 operations minimum for silver; 50,000 operations minimum for gold 50,000 operations minimum for silver at 3A @ 125V AC

**Nominal Operating Force:** Momentary Action: 1-pole 9.32N; 2-pole 16.18N; 4-pole 25.54N;  
Alternate Action: 1-pole 4.41N; 2-pole 7.06N; 4-pole 11.77N

<b>Contact Timing:</b>	Slow make, slow break		
<b>Plunger Travel:</b>	Screw-on Cap (Mom.)	Screw-on Cap (Alt.)	Snap-on Cap (Mom. & Alt.)
<b>Pretravel:</b>	.028" (0.71mm)	.110" (2.80mm)	.125" (3.19mm)
<b>Overtravel:</b>	.043" (1.09mm)	.043" (1.10mm)	.050" (1.26mm)
<b>Total Travel</b>	.071" (1.80mm)	.153" (3.90mm)	.175" (4.45mm)

## Materials & Finishes

<b>Plunger:</b>	Brass w/nickel plating; polyacetal w/B1 bushing	<b>Bushing:</b>	Brass with nickel plating
<b>Frame:</b>	Stainless steel	<b>Case:</b>	Diallyl phthalate resin (UL94V-0)
<b>Movable Contactor:</b>	Phosphor bronze with silver or gold plating		
<b>Movable Contacts:</b>	Silver alloy (code W); copper with gold plating (code G); or silver alloy with gold plating (code A)		
<b>Stationary Contacts:</b>	Silver with silver plating (code W); copper or brass with gold plating (code G); or silver with gold plating (code A)		
<b>Terminals:</b>	Copper or brass with silver plating; copper or brass with gold plating		

## Environmental Data

<b>Operating Temp Range:</b>	-30°C through +85°C (-22°F through +185°F)
<b>Humidity:</b>	90 ~ 95% humidity for 96 hours @ 40°C (104°F)
<b>Vibration:</b>	10 ~ 55Hz with peak-to-peak amplitude of 1.5mm traversing the frequency range & returning in 1 minute; 3 right angled directions for 2 hours
<b>Shock:</b>	50G (490m/s <sup>2</sup> ) acceleration (tested in 6 right angled directions, with 5 shocks in each direction)
<b>Sealing:</b>	B3 & D3 bushing options equivalent to IP67

## Installation

<b>Mounting Torque:</b>	1.5Nm (13.0 lb•in) for double nut; .7Nm (6.0 lb•in) for single nut
<b>Cap Installation Force:</b>	80.0N (18.0 lbf) maximum downward force on actuator
<b>Soldering Time &amp; Temp:</b>	Wave Soldering (PC version): See Profile A in Supplement section. Manual Soldering: See Profile A in Supplement section.
<b>Process Seal:</b>	These devices are not process sealed. Hand clean locally using alcohol based solution.

## Standards & Certifications

<b>Flammability Standards:</b>	UL94V-0 case
<b>UL:</b>	<b>File No. E44145 - Recognized only when ordered with marking on switch.</b> Add "/U" or "/CUL" before dash in part number to order UL recognized switch. All models recognized at 6A @ 125V AC or 3A @ 250V AC or 0.4VA max. @ 28V DC max.
<b>CSA:</b>	<b>File No. 023535_0_000 - Certified only when ordered with marking on switch.</b> Add "/C" before dash in part number to order CSA certified switch. All models certified at 6A @ 125V AC or 3A @ 250V AC or 0.4VA max. @ 28V max.

# Distinctive Characteristics

Guide interlocked with actuator block prevents window locking and maintains correct plunger alignment to assure contact stability.

Employs an over-center actuator mechanism, which diminishes sparking and increases operating life in AC circuits.

High torque bushing construction prevents rotation or separation from frame during installation.

Splashproof option (D3 and B3 bushing codes) features an o-ring within the bushing and one under the face nut to protect from splashed, sprayed, or spilled liquids.

High insulating barriers, formed in the molded diallyl phthalate case, increase isolation of circuits in multipole devices.

Prominent external insulating barriers increase insulation resistance and dielectric strength.



Epoxy sealed terminals prevent entry of solder flux and other contaminants.

Clinching of the frame to the case well above the base and terminals provides 1,500V dielectric strength.



Actual Size



	Bushing Mount	Page C74
	Bracket PC Mount	Page C80
	Large Bushing	Page C87

- Toggle
- Rockers
- Pushbuttons**
- Illuminated PB
- Programmable
- Keylocks
- Rotaries
- Slides
- Tactiles
- Tilt
- Touch
- Indicators
- Accessories
- Supplement

### TYPICAL SWITCH ORDERING EXAMPLE

**MB**

**2011**

**S**

**S2**

**G**

**13**

**C**

**A**

#### Poles & Circuits

<b>2011</b>	SPDT	ON	(ON)
<b>2065</b>	SPDT	ON	ON
<b>2061</b>	DPDT	ON	(ON)
<b>2085</b>	DPDT	ON	ON
<b>2181</b>	4PDT	ON	(ON)
<b>2185</b>	4PDT	ON	ON

( ) = Momentary

4-pole not for use with right angle terminals

#### Contact Materials & Ratings

<b>W</b>	Silver Rated 6A @ 125V AC & 3A @ 250V AC
<b>G</b>	Gold Rated 0.4VA max @ 28V AC/DC max
<b>A</b>	Gold over Silver Rated 6A @ 125V AC & 0.4VA max @ 28V AC/DC max

#### Caps

<b>B</b>	.315" (8.0mm) Diameter
<b>C</b>	.394" (10.0mm) Diameter

#### Cap Colors

<b>A</b>	Black
<b>B</b>	White
<b>C</b>	Red
<b>E</b>	Yellow
<b>F</b>	Green
<b>G</b>	Blue
<b>H</b>	Gray

#### Plunger Type

<b>S</b>	Plunger for Screw-on Caps
----------	---------------------------

#### Bushings

<b>S2</b>	.335" (8.5mm) Smooth with Keyway
<b>S1</b>	.335" (8.5mm) Threaded with Keyway
<b>A2</b>	.200" (5.08mm) Smooth with Keyway Only Available in Part Numbers MB2011SA2G31 & MB2011SA2W31

#### Terminals

<b>13</b>	.250" (6.35mm) Straight PC with Bracket
<b>40</b>	.150" (3.81mm) Vertical PC
<b>45</b>	.100" (2.54mm) Vertical PC
<b>30</b>	Right Angle PC with .646" (16.4mm) Support to Terminals Available in 1- & 2-pole only
<b>31</b>	Right Angle PC with .500" (12.7mm) Support to Terminals Available in 1-pole only

#### IMPORTANT:

Switches are supplied without UL, cULus & CSA marking unless specified. **UL, cULus & CSA recognized only when ordered with marking on the switch.** Specific models, ratings, & ordering instructions are noted on General Specifications page.







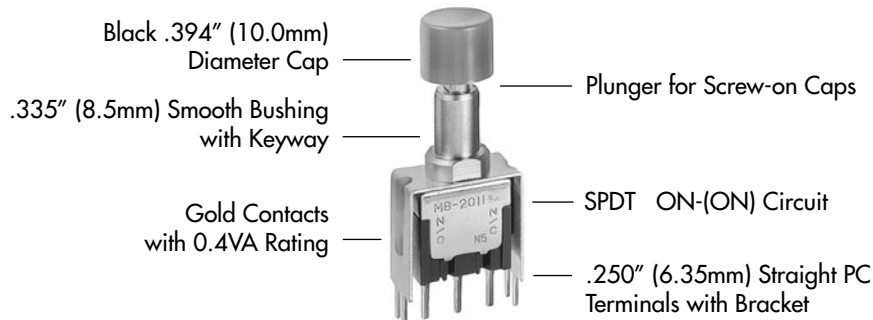









#### DESCRIPTION FOR TYPICAL ORDERING EXAMPLE

**MB2011SS2G13-CA**

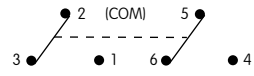

## POLES & CIRCUITS

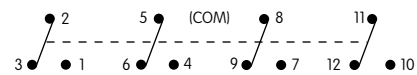
Pole	Model	Plunger Position ( ) = Momentary		Connected Terminals		Throw & Switch Schematics
		Normal 	Down 	Normal 	Down 	
SP	MB2011 MB2065	ON 	(ON) ON	2-3 	2-1 	SPDT Note: Terminal numbers are not actually on the switch. 
DP	MB2061 MB2085	ON 	(ON) ON	2-3 5-6 	2-1 5-4 	DPDT 
4P	MB2181 MB2185	ON 	(ON) ON	2-3 5-6 8-9 11-12 	2-1 5-4 8-7 11-10 	4PDT 

## PLUNGER TYPE

On alternate action models, after transferring circuit, the plunger returns to its original position and does not latch down.

**S**

### Plunger for Screw-on Caps

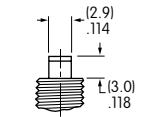

Momentary Plunger Length

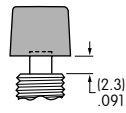

Momentary Cap Location

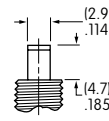

Alternate Plunger Length

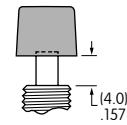

Alternate Cap Location

## BUSHINGS

**S2**

**.335" (8.5mm)**  
Smooth with Keyway

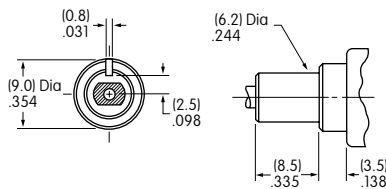

**S1**

**.335" (8.5mm)**  
Threaded with Keyway

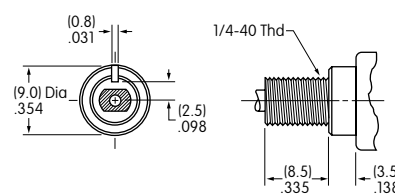

**A2**

**.200" (5.08mm)**  
Smooth with Keyway

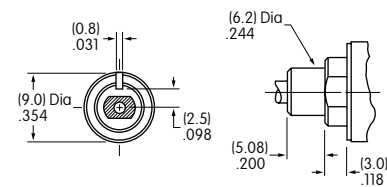

Standard hardware: 2 hex nuts (AT513H)  
& 1 lockwasher (AT509)  
Optional hardware: Locking ring (AT507)

Only available in part numbers  
MB2011SA2W31 & MB2011SA2G31

### Panel Cutouts

For S2, S1, or A2 Bushing  
with Keyway

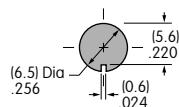

With Optional  
Locking Ring

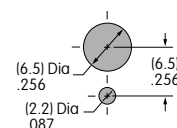

Maximum Panel Thickness with  
Standard Hardware: .154" (3.9mm)

### CONTACT MATERIALS & RATINGS

<b>W</b>	Silver over Silver	Power Level	6A @ 125V AC & 3A @ 250V AC
<b>G</b>	Gold over Brass or Copper	Logic Level	0.4VA maximum @ 28V AC/DC maximum Note: Complete explanation of operating range in Supplement section.
<b>A</b>	Gold over Silver	Power Level or Logic Level	6A @ 125V AC & 3A @ 250V AC or 0.4VA maximum @ 28V AC/DC maximum Note: This dual rated option is suitable when two or more identical switches are used in logic and in power circuits within the same application. See Supplement section for complete explanation of dual rating and operating range.

### TERMINALS

**13** .250" (6.35mm) Straight PC with Bracket

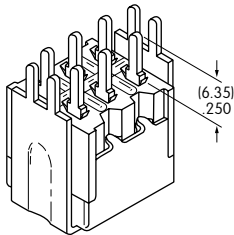

**40** .150" (3.81mm) Vertical PC

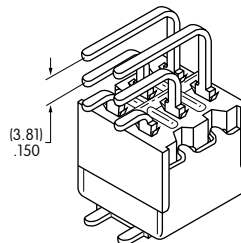

**45** .100" (2.54mm) Vertical PC

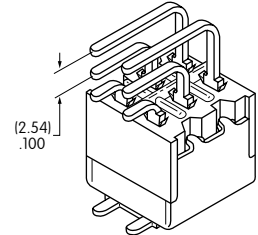

**30** Right Angle PC with .646" (16.4mm) Support to Terminal

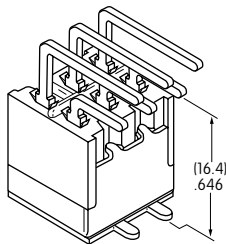

Only Available in 1 & 2 Pole

**31** Right Angle PC with .500" (12.7mm) Support to Terminal

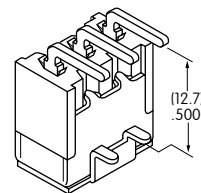

Note: Full dimensioned drawings appear on the following pages.

### CAPS & CAP COLORS

**B** AT413  
.315" (8.0mm) Diameter  
Screw-on Cap

Cap Material: PBT  
Finish: Glossy



**C** AT407  
.394" (10.0mm) Diameter  
Screw-on Cap

Cap Material: PBT  
Finish: Glossy

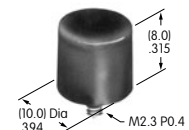

Cap Colors Available: **A** Black **B** White **C** Red **E** Yellow **F** Green **G** Blue **H** Gray

## TYPICAL SWITCH DIMENSIONS

### Single Pole

### Straight PC with Bracket

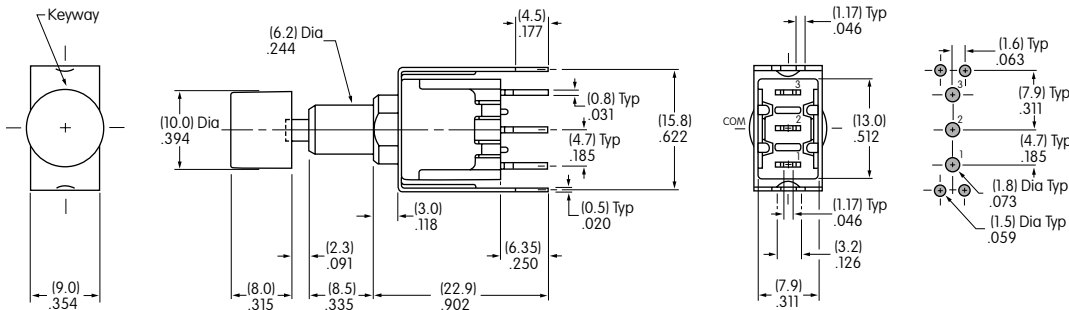

**MB2011SS2G13-CA**

### Double Pole

### Straight PC with Bracket

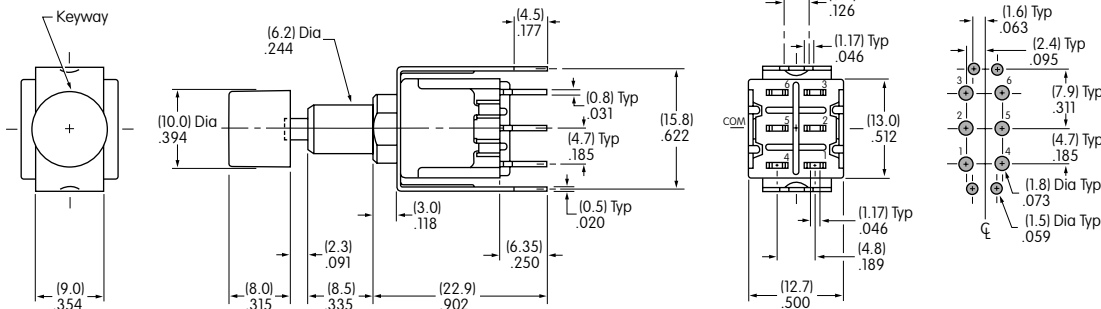

**MB2061SS2G13-CA**

### Four Pole

### Straight PC with Bracket

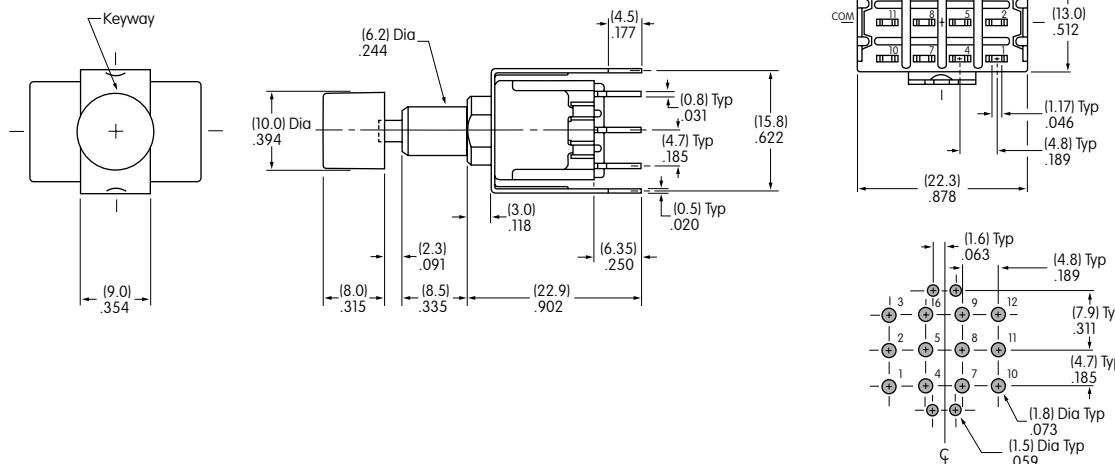

**MB2181SS2G13-CA**

- Toggle
- Rockers
- Pushbuttons**
- Illuminated PB
- Programmable
- Keylocks
- Rotaries
- Slides
- Tactiles
- Tilt
- Touch
- Indicators
- Accessories
- Supplement

## TYPICAL SWITCH DIMENSIONS

### .150" (3.81mm) Vertical PC

### Single Pole

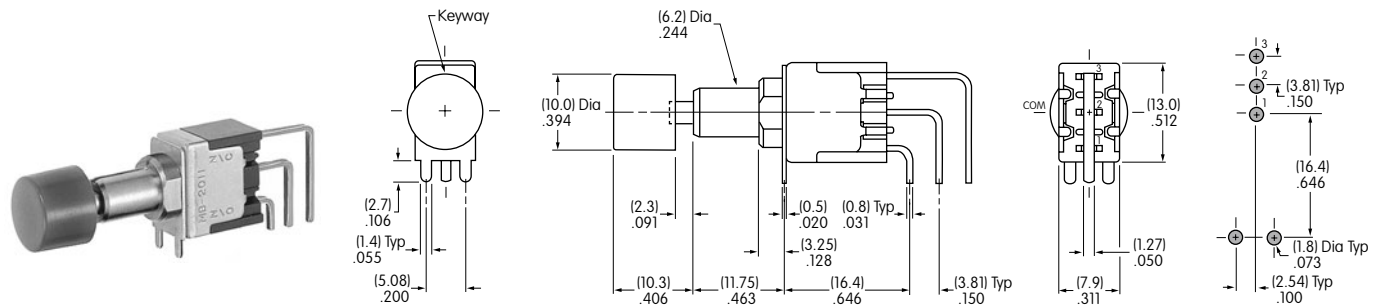

MB2011SS2G40-CA

### .150" (3.81mm) Vertical PC

### Double Pole

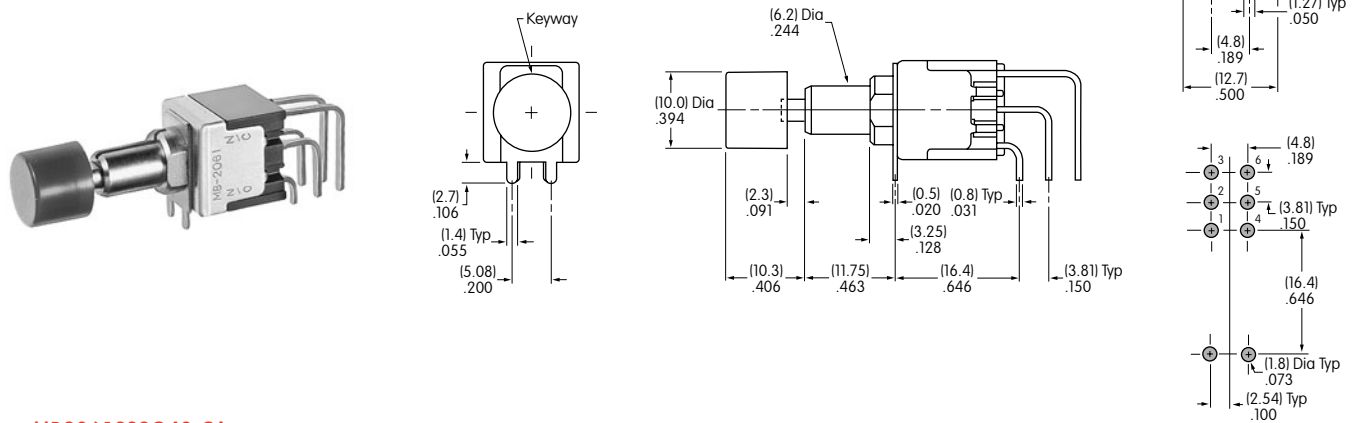

MB2061SS2G40-CA

### .150" (3.81mm) Vertical PC

### Four Pole

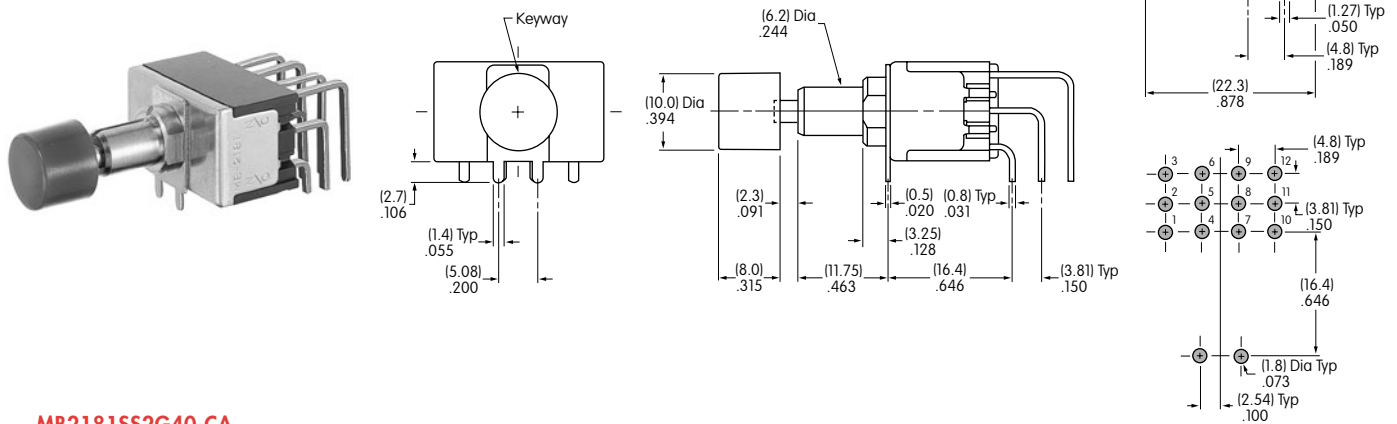

MB2181SS2G40-CA

TYPICAL SWITCH DIMENSIONS

Single Pole

.100" (2.54mm) Vertical PC

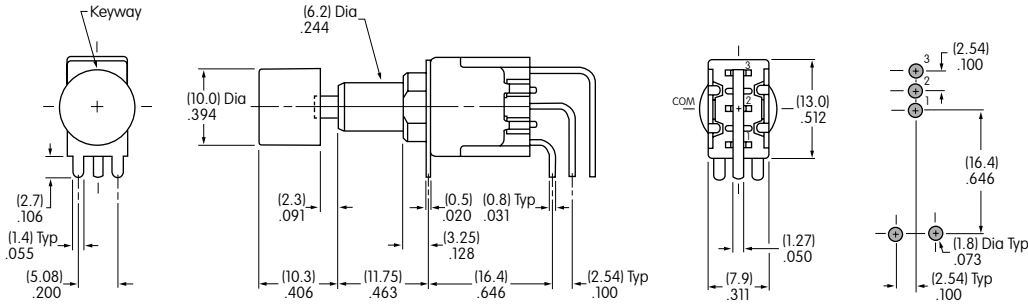

MB2011SS2G45-CA

Double Pole

.100" (2.54mm) Vertical PC

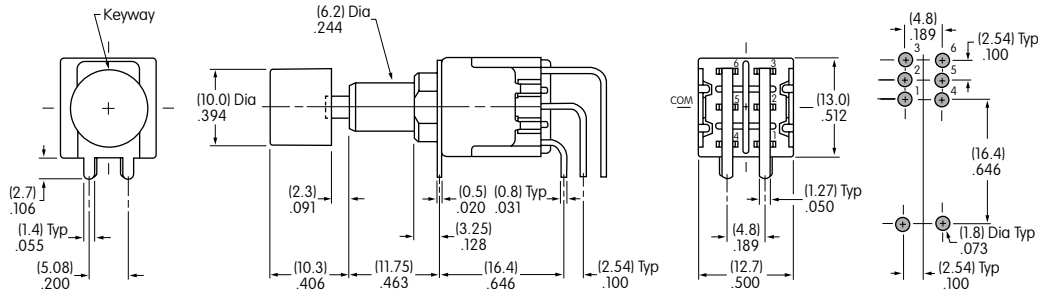

MB2061SS2G45-CA

Four Pole

.100" (2.54mm) Vertical PC

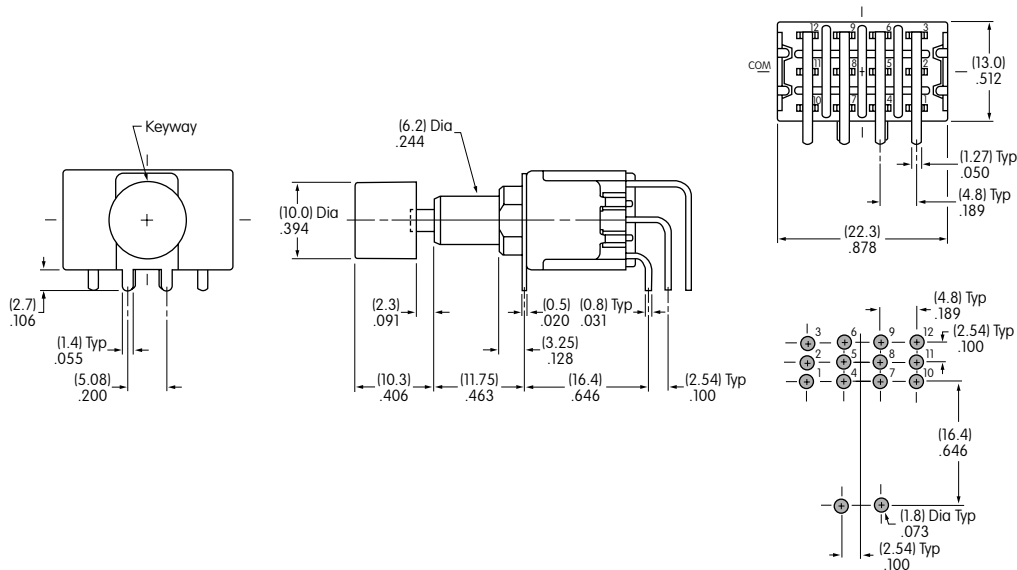

MB2181SS2G45-CA



## TYPICAL SWITCH DIMENSIONS

### Right Angle PC

### Single Pole

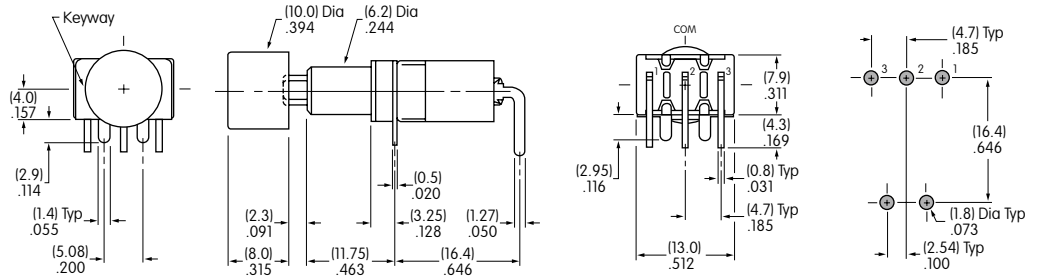

**MB2011SS2G30-CA**

### Right Angle PC

### Double Pole

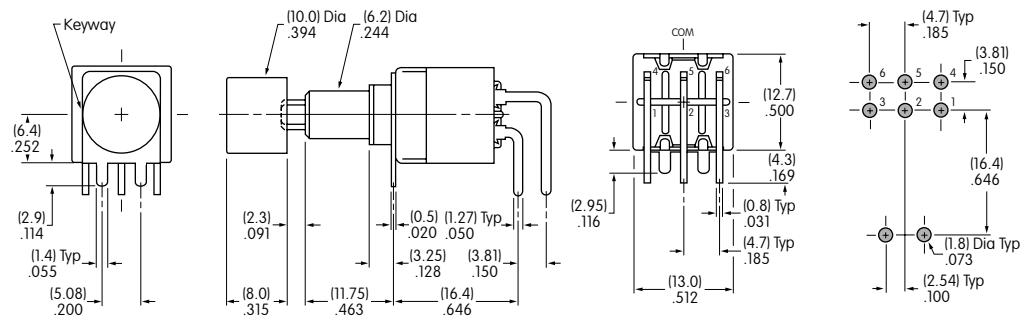

**MB2061SS2G30-CA**

### Right Angle PC with .500" (12.7mm) Support to Terminal

### Single Pole

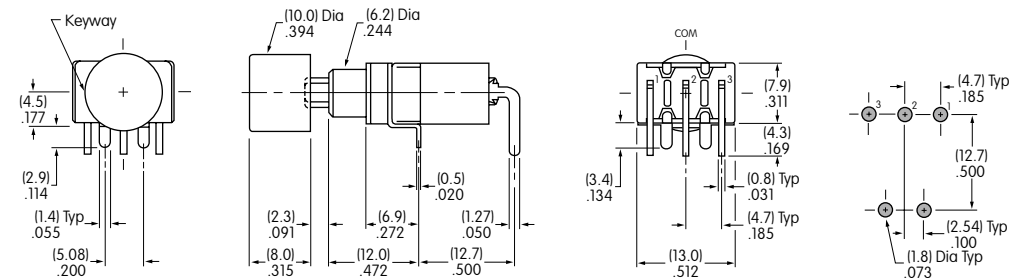

**MB2011SA2G31-CA**



Компания «ЭлектроПласт» предлагает заключение долгосрочных отношений при поставках импортных электронных компонентов на взаимовыгодных условиях!

Наши преимущества:

- Оперативные поставки широкого спектра электронных компонентов отечественного и импортного производства напрямую от производителей и с крупнейших мировых складов;
- Поставка более 17-ти миллионов наименований электронных компонентов;
- Поставка сложных, дефицитных, либо снятых с производства позиций;
- Оперативные сроки поставки под заказ (от 5 рабочих дней);
- Экспресс доставка в любую точку России;
- Техническая поддержка проекта, помощь в подборе аналогов, поставка прототипов;
- Система менеджмента качества сертифицирована по Международному стандарту ISO 9001;
- Лицензия ФСБ на осуществление работ с использованием сведений, составляющих государственную тайну;
- Поставка специализированных компонентов (Xilinx, Altera, Analog Devices, Intersil, Interpoint, Microsemi, Aeroflex, Peregrine, Syfer, Eurofarad, Texas Instrument, Miteq, Cobham, E2V, MA-COM, Hittite, Mini-Circuits, General Dynamics и др.);

Помимо этого, одним из направлений компании «ЭлектроПласт» является направление «Источники питания». Мы предлагаем Вам помощь Конструкторского отдела:

- Подбор оптимального решения, техническое обоснование при выборе компонента;
- Подбор аналогов;
- Консультации по применению компонента;
- Поставка образцов и прототипов;
- Техническая поддержка проекта;
- Защита от снятия компонента с производства.



#### Как с нами связаться

**Телефон:** 8 (812) 309 58 32 (многоканальный)

**Факс:** 8 (812) 320-02-42

**Электронная почта:** [org@eplast1.ru](mailto:org@eplast1.ru)

**Адрес:** 198099, г. Санкт-Петербург, ул. Калинина, дом 2, корпус 4, литера А.