

## 1 Form A Solid-State Relay

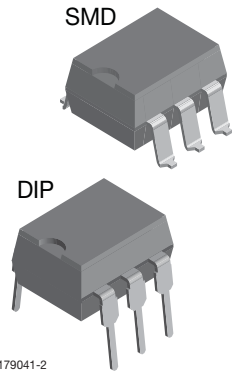

i179041-2

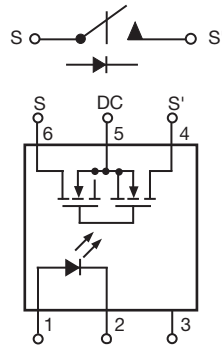

### FEATURES

- Isolation test voltage 5300 V<sub>RMS</sub>
- Current limit protection built in
- High reliability monolithic output die
- Low power consumption
- Clean bounce free switching
- High surge capability
- Surface mountable
- Compliant to RoHS Directive 2002/95/EC and in accordance to WEEE 2002/96/EC

**RoHS**  
COMPLIANT

### APPLICATIONS

- General telecom switching
- Instrumentation
- Industrial controls

### AGENCY APPROVALS

- UL1577: file no. E52744 system code H, double protection  
 CSA: certification no. 093751  
 BSI: certification no. 7979/7980  
 DIN EN: 60747-5-2 (VDE 0884)/60747-5-5 (pending), available with option 1  
 FIMKO: 25419

### DESCRIPTION

The LH1510 is an SPST normally open switch (1 form A) that can replace electromechanical relays in many applications. The relay is constructed using a GaAlAs LED for actuation control and an integrated monolithic die for the switch output. The die, fabricated in a high-voltage dielectrically isolated technology, is comprised of a photodiode array, switch control circuitry, and MOSFET switches. In addition, the relay employs current-limiting circuitry enabling it to pass lightning surge testing as per ANSI/TIA-968-B and other regulatory voltage surge requirements when overvoltage protection is provided. The LH1510 is the only relay in the family that provides current limiting for unidirectional DC applications.

### ORDERING INFORMATION

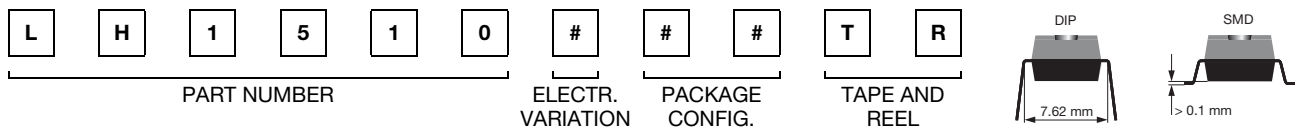

PACKAGE	UL, CSA, BSI, FIMKO
SMD-6, tubes	LH1510AAB
SMD-6, tape and reel	LH1510AABTR
DIP-6, tubes	LH1510AT

### ABSOLUTE MAXIMUM RATINGS (T<sub>amb</sub> = 25 °C, unless otherwise specified)

PARAMETER	TEST CONDITION	SYMBOL	VALUE	UNIT
<b>INPUT</b>				
LED continuous forward current		I <sub>F</sub>	50	mA
LED reverse voltage	I <sub>R</sub> ≤ 10 μA	V <sub>R</sub>	8	V
<b>OUTPUT</b>				
DC or peak AC load voltage	I <sub>L</sub> ≤ 50 μA	V <sub>L</sub>	200	V
Continuous DC load current - bidirectional operation		I <sub>L</sub>	200	mA
Continuous DC load current - unidirectional operation		I <sub>L</sub>	350	mA
Peak load current (single shot)	t = 100 ms	I <sub>P</sub>	(1)	



<b>ABSOLUTE MAXIMUM RATINGS</b> ( $T_{amb} = 25\text{ }^{\circ}\text{C}$ , unless otherwise specified)				
PARAMETER	TEST CONDITION	SYMBOL	VALUE	UNIT
<b>SSR</b>				
Ambient temperature range		$T_{amb}$	- 40 to + 85	$^{\circ}\text{C}$
Storage temperature range		$T_{stg}$	- 40 to + 150	$^{\circ}\text{C}$
Pin soldering temperature <sup>(2)</sup>	$t = 10\text{ s max.}$	$T_{sld}$	260	$^{\circ}\text{C}$
Input to output isolation voltage		$V_{ISO}$	5300	$V_{RMS}$
Output power dissipation (continuous)		$P_{diss}$	550	mW

**Notes**

- Stresses in excess of the absolute maximum ratings can cause permanent damage to the device. Functional operation of the device is not implied at these or any other conditions in excess of those given in the operational sections of this document. Exposure to absolute maximum ratings for extended periods of the time can adversely affect reliability.
- (1) Refer to current limit performance application note 58 for a discussion on relay operation during transient currents.
- (2) Refer to reflow profile for soldering conditions for surface mounted devices (SMD). Refer to wave profile for soldering conditions for through hole devices (DIP).

<b>ELECTRICAL CHARACTERISTICS</b> ( $T_{amb} = 25\text{ }^{\circ}\text{C}$ , unless otherwise specified)						
PARAMETER	TEST CONDITION	SYMBOL	MIN.	TYP.	MAX.	UNIT
<b>INPUT</b>						
LED forward current, switch turn-on	$I_L = 100\text{ mA}$ , $t = 10\text{ ms}$	$I_{Fon}$		0.95	2	mA
LED forward current, switch turn-off	$V_L = \pm 150\text{ V}$	$I_{Foff}$	0.2	0.85		mA
LED forward voltage	$I_F = 10\text{ mA}$	$V_F$	1.15	1.27	1.45	V
<b>OUTPUT</b>						
ON-resistance AC/DC: pin 4 ( $\pm$ ) to 6 ( $\pm$ )	$I_F = 5\text{ mA}$ , $I_L = 50\text{ mA}$	$R_{ON}$	6	11.27	15	$\Omega$
ON-resistance DC: pin 4, 6 (+) to 5 ( $\pm$ )	$I_F = 5\text{ mA}$ , $I_L = 100\text{ mA}$	$R_{ON}$	1.5	3.15	3.75	$\Omega$
Off-resistance	$I_F = 0\text{ mA}$ , $V_L = \pm 100\text{ V}$	$R_{OFF}$	0.5	80		$G\Omega$
Current limit AC/DC: pin 4 ( $\pm$ ) to 6 ( $\pm$ )	$I_F = 5\text{ mA}$ , $V_L = \pm 5\text{ V}$ , $t = 5\text{ ms}$	$I_{LMT}$	300	368	450	mA
Current limit DC: pin 4, 6 (+) to 5 ( $\pm$ )	$I_F = 5\text{ mA}$ , $V_L = \pm 4\text{ V}$ , $t = 5\text{ ms}$	$I_{LMT}$	600	736	920	mA
Off-state leakage current	$I_F = 0\text{ mA}$ , $V_L = \pm 100\text{ V}$	$I_O$		2.36	200	nA
	$I_F = 0\text{ mA}$ , $V_L = \pm 200\text{ V}$	$I_O$		79.2	1	$\mu\text{A}$
Output capacitance pin 4 to 6	$I_F = 0\text{ mA}$ , $V_L = 1\text{ V}$	$C_O$		27.75		pF
	$I_F = 0\text{ mA}$ , $V_L = 50\text{ V}$	$C_O$		10.82		pF
Switch offset	$I_F = 5\text{ mA}$	$V_{OS}$		0.17		$\mu\text{V}$
<b>TRANSFER</b>						
Capacitance (input to output)	$V_{ISO} = 1\text{ V}$	$C_{IO}$		0.72		pF

**Note**

- Minimum and maximum values are testing requirements. Typical values are characteristics of the device and are the result of engineering evaluations. Typical values are for information only and are not part of the testing requirements.

<b>SWITCHING CHARACTERISTICS</b> ( $T_{amb} = 25\text{ }^{\circ}\text{C}$ , unless otherwise specified)						
PARAMETER	TEST CONDITION	SYMBOL	MIN.	TYP.	MAX.	UNIT
Turn-on time	$I_F = 5\text{ mA}$ , $I_L = 50\text{ mA}$	$t_{on}$		0.5	2	ms
Turn-off time	$I_F = 5\text{ mA}$ , $I_L = 50\text{ mA}$	$t_{off}$		0.7	2	ms



SAFETY AND INSULATION RATINGS				
PARAMETER	TEST CONDITION	SYMBOL	VALUE	UNIT
Climatic classification	IEC 68 part 1		40/85/21	
Pollution degree	DIN VDE 0109		2	
Tracking resistance (comparative tracking index)	Insulation group IIIa	CTI	175	
Highest allowable overvoltage	Transient overvoltage	$V_{IOTM}$	8000	$V_{peak}$
Max. working insulation voltage	Recurring peak voltage	$V_{IORM}$	890	$V_{peak}$
Insulation resistance at 25 °C	$V_{IO} = 500 V$	$R_{IS}$	$\geq 10^{12}$	$\Omega$
Insulation resistance at $T_S$		$R_{IS}$	$\geq 10^9$	$\Omega$
Insulation resistance at 100 °C		$R_{IS}$	$\geq 10^{11}$	$\Omega$
Partial discharge test voltage	Method e a, $V_{pd} = V_{IORM} \times 1.875$	$V_{pd}$	1669	$V_{peak}$
Safety limiting values - maximum values allowed in the event of a failure	Case temperature	$T_{SI}$	175	°C
	Input current	$I_{SI}$	300	mA
	Output power	$P_{SO}$	700	mW
Minimum external air gap (clearance)	Measured from input terminals to output terminals, shortest distance through air		$\geq 7$	mm
Minimum external tracking (creepage)	Measured from input terminals to output terminals, shortest distance path along body		$\geq 7$	mm

**TYPICAL CHARACTERISTICS** ( $T_{amb} = 25\text{ °C}$ , unless otherwise specified)

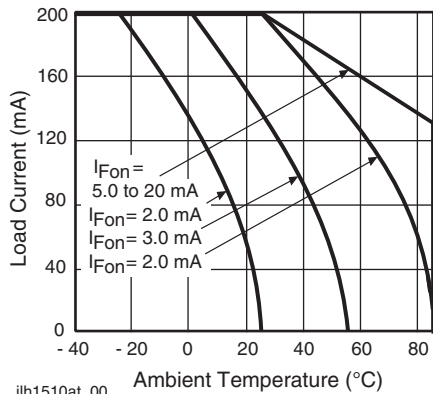

ilh1510at\_00

Fig. 1 - Recommended Operating Conditions

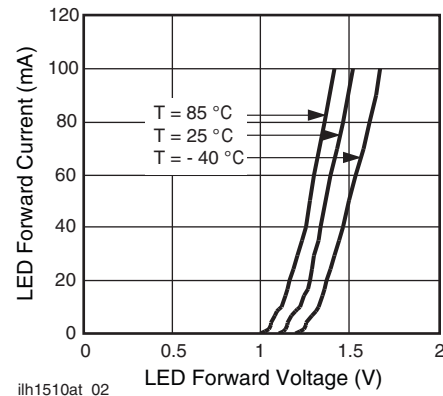

ilh1510at\_02

Fig. 3 - LED Forward Current vs. LED Forward Voltage

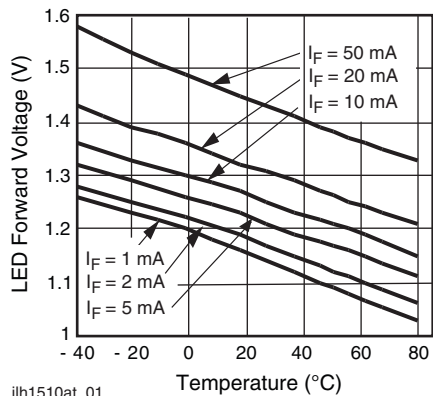

ilh1510at\_01

Fig. 2 - LED Voltage vs. Temperature

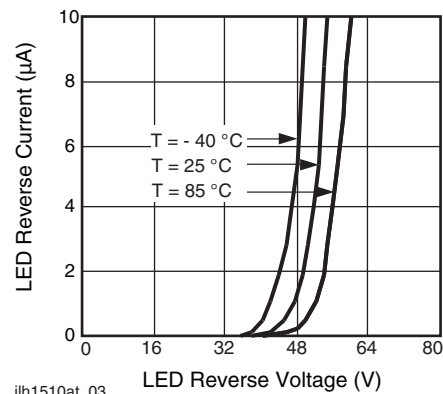

ilh1510at\_03

Fig. 4 - LED Reverse Current vs. LED Reverse Voltage

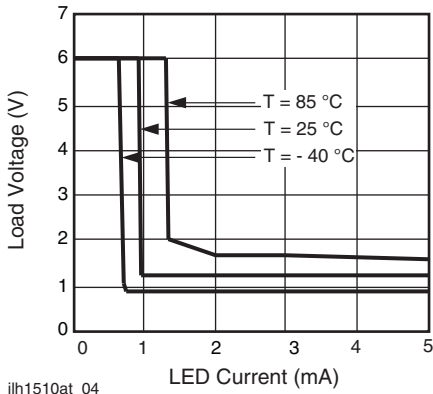

Fig. 5 - LED Current vs. Load Voltage

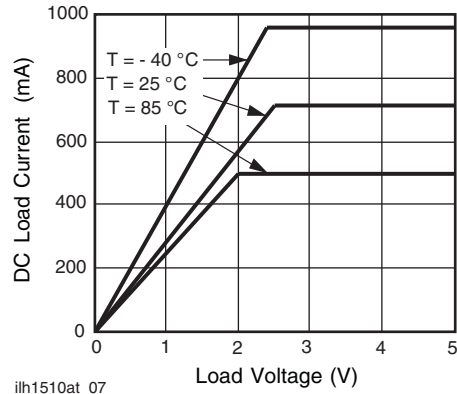

Fig. 8 - DC Load Current vs. Load Voltage

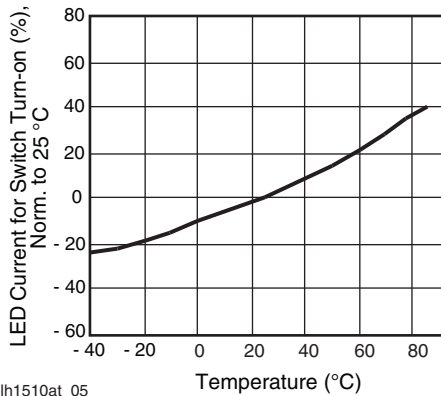

Fig. 6 - LED Current for Switch Turn-on vs. Temperature

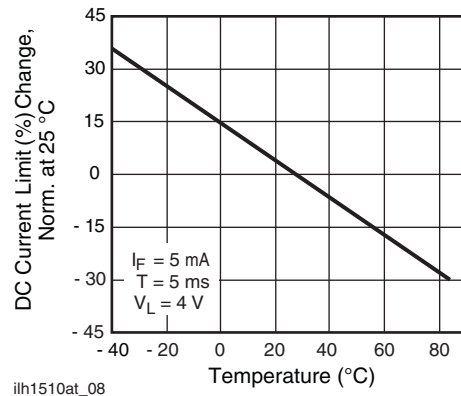

Fig. 9 - DC Current Limit vs. Temperature

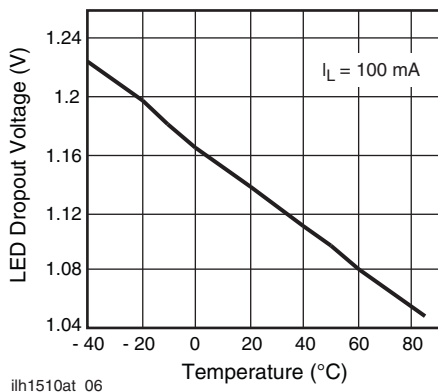

Fig. 7 - LED Dropout Voltage vs. Temperature

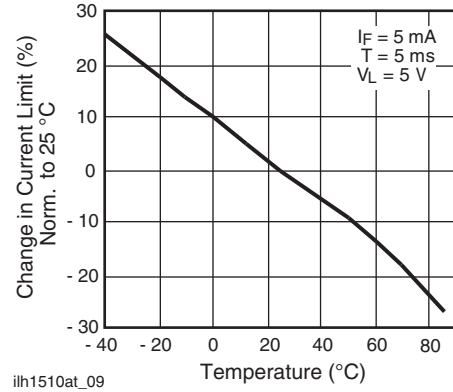

Fig. 10 - Current Limit vs. Temperature

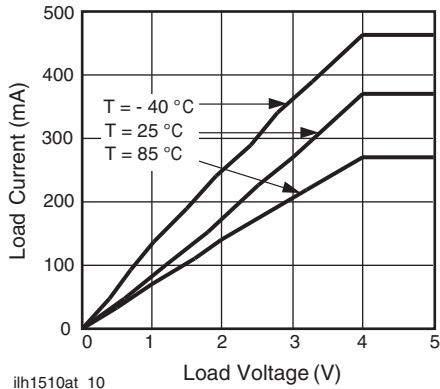

Fig. 11 - Load Current vs. Load Voltage

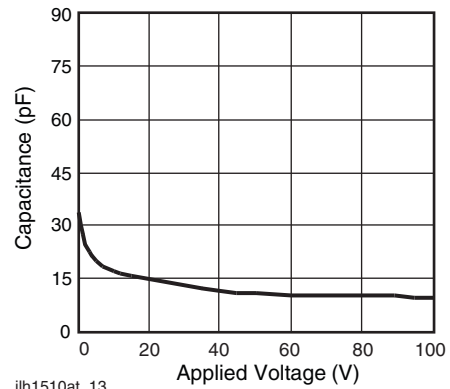

Fig. 14 - Switch Terminal Capacitance vs. Applied Voltage

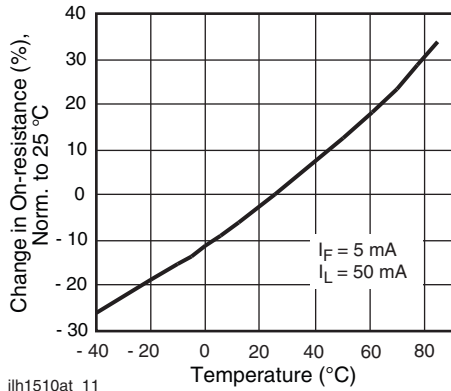

Fig. 12 - On-Resistance vs. Temperature

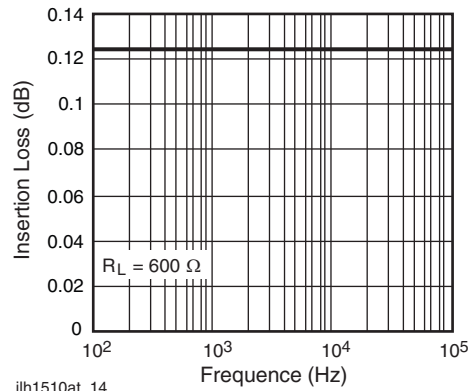

Fig. 15 - Insertion Loss vs. Frequency

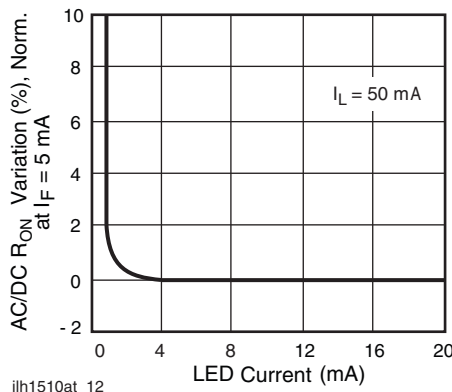

Fig. 13 - Variation in On-Resistance vs. LED Current

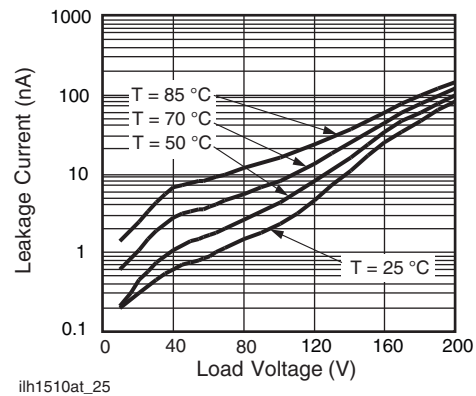
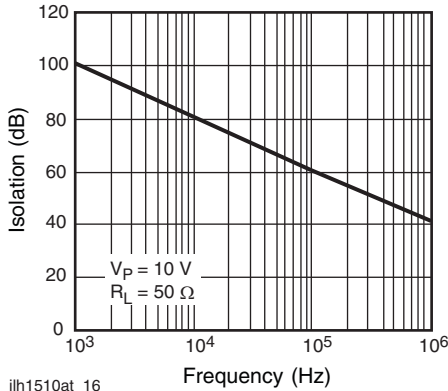
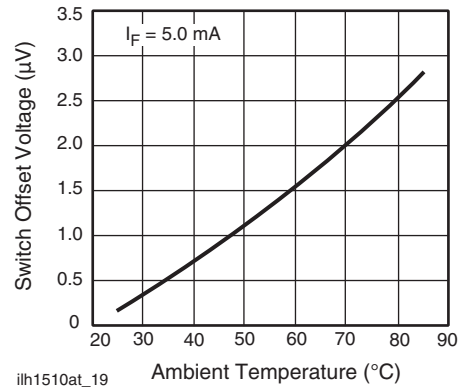

Fig. 16 - Leakage Current vs. Applied Voltage



ih1510at\_16

Fig. 17 - Output Isolation



ih1510at\_19

Fig. 20 - Switch Offset Voltage vs. Temperature

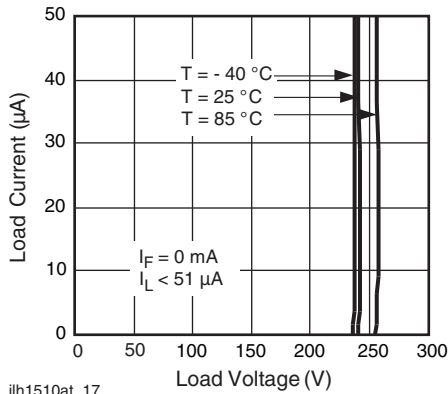

ih1510at\_17

Fig. 18 - Switch Breakdown Voltage vs. Load Current

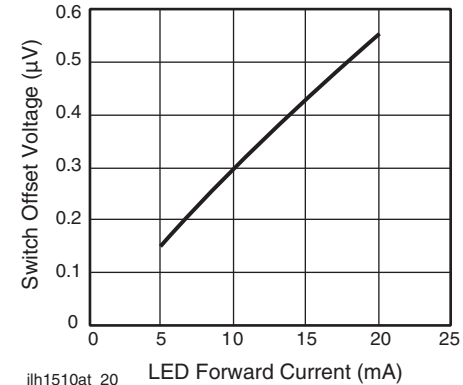

ih1510at\_20

Fig. 21 - Switch Offset Voltage vs. LED Current

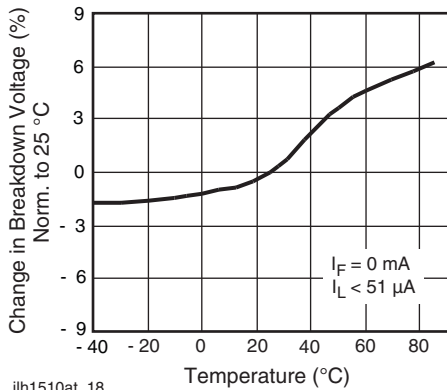

ih1510at\_18

Fig. 19 - Switch Breakdown Voltage vs. Temperature

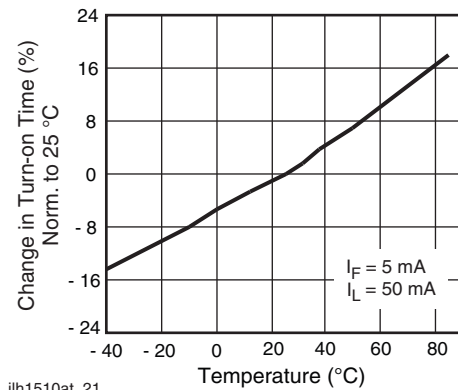

ih1510at\_21

Fig. 22 - Turn-on Time vs. Temperature

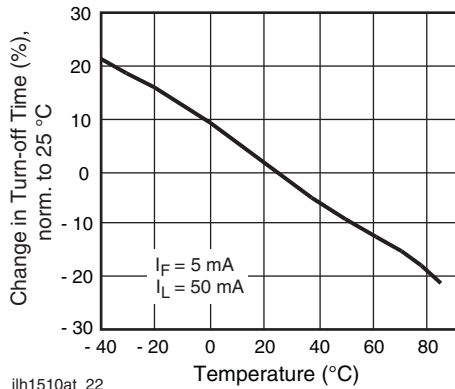

ih1510at\_22

Fig. 23 - Turn-off Time vs. Temperature

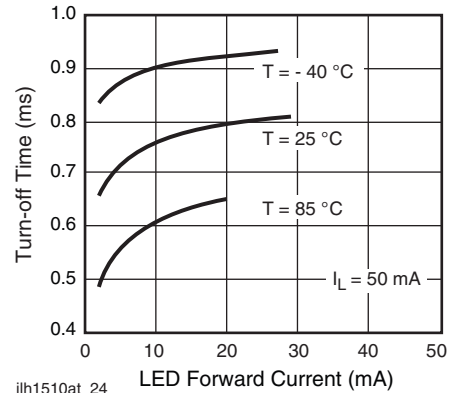

ih1510at\_24

Fig. 25 - Turn-off Time vs. LED Current

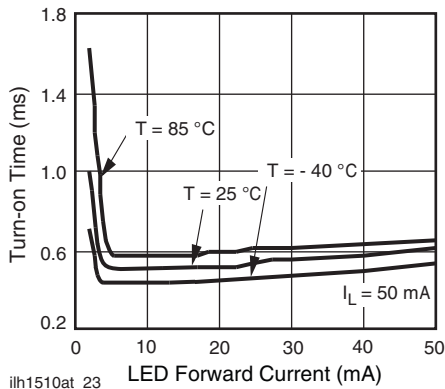

ih1510at\_23

Fig. 24 - Turn-on Time vs. LED Current

## PACKAGE DIMENSIONS in millimeters

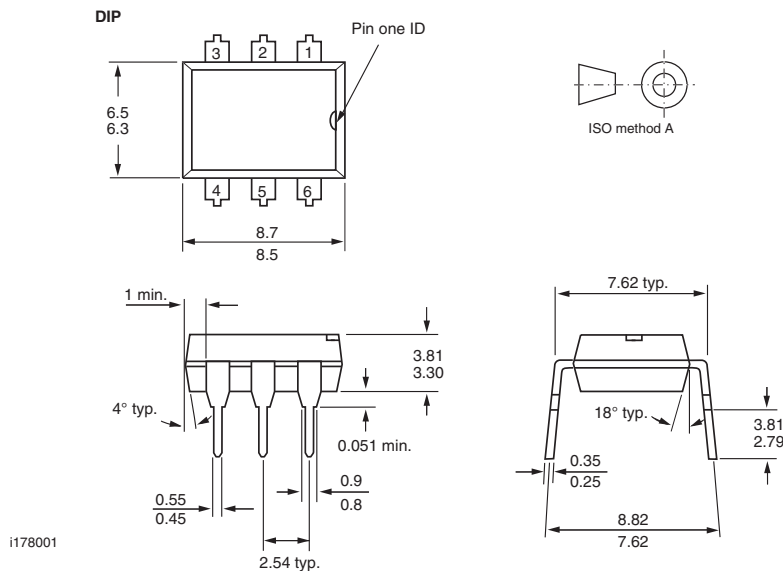

i178001

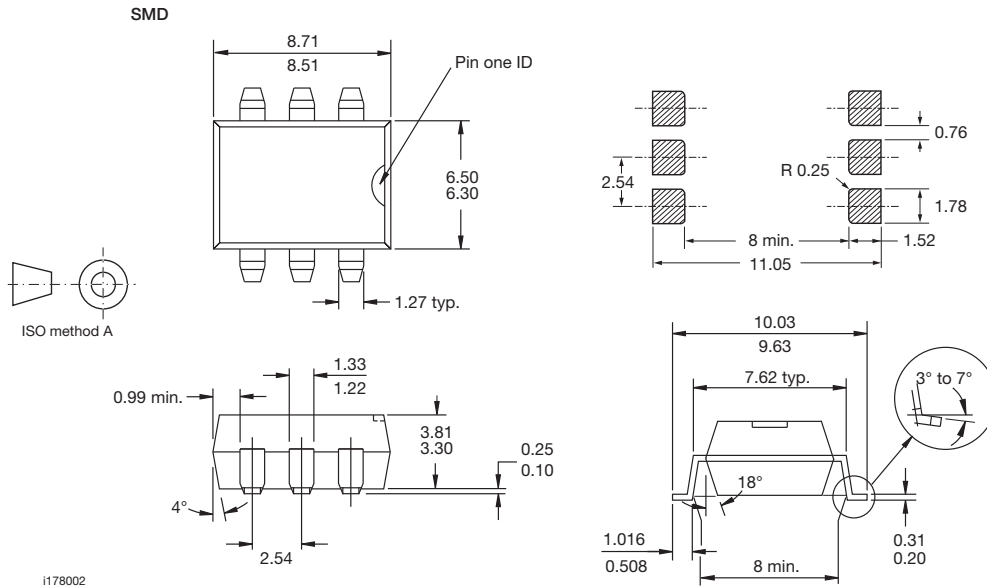

## PACKAGE MARKING

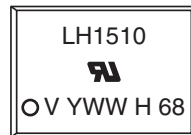

### Note

- Tape and reel suffix (TR) is not part of the package marking.





## Disclaimer

ALL PRODUCT, PRODUCT SPECIFICATIONS AND DATA ARE SUBJECT TO CHANGE WITHOUT NOTICE TO IMPROVE RELIABILITY, FUNCTION OR DESIGN OR OTHERWISE.

Vishay Intertechnology, Inc., its affiliates, agents, and employees, and all persons acting on its or their behalf (collectively, "Vishay"), disclaim any and all liability for any errors, inaccuracies or incompleteness contained in any datasheet or in any other disclosure relating to any product.

Vishay makes no warranty, representation or guarantee regarding the suitability of the products for any particular purpose or the continuing production of any product. To the maximum extent permitted by applicable law, Vishay disclaims (i) any and all liability arising out of the application or use of any product, (ii) any and all liability, including without limitation special, consequential or incidental damages, and (iii) any and all implied warranties, including warranties of fitness for particular purpose, non-infringement and merchantability.

Statements regarding the suitability of products for certain types of applications are based on Vishay's knowledge of typical requirements that are often placed on Vishay products in generic applications. Such statements are not binding statements about the suitability of products for a particular application. It is the customer's responsibility to validate that a particular product with the properties described in the product specification is suitable for use in a particular application. Parameters provided in datasheets and/or specifications may vary in different applications and performance may vary over time. All operating parameters, including typical parameters, must be validated for each customer application by the customer's technical experts. Product specifications do not expand or otherwise modify Vishay's terms and conditions of purchase, including but not limited to the warranty expressed therein.

Except as expressly indicated in writing, Vishay products are not designed for use in medical, life-saving, or life-sustaining applications or for any other application in which the failure of the Vishay product could result in personal injury or death. Customers using or selling Vishay products not expressly indicated for use in such applications do so at their own risk and agree to fully indemnify and hold Vishay and its distributors harmless from and against any and all claims, liabilities, expenses and damages arising or resulting in connection with such use or sale, including attorneys fees, even if such claim alleges that Vishay or its distributor was negligent regarding the design or manufacture of the part. Please contact authorized Vishay personnel to obtain written terms and conditions regarding products designed for such applications.

No license, express or implied, by estoppel or otherwise, to any intellectual property rights is granted by this document or by any conduct of Vishay. Product names and markings noted herein may be trademarks of their respective owners.



Компания «ЭлектроПласт» предлагает заключение долгосрочных отношений при поставках импортных электронных компонентов на взаимовыгодных условиях!

Наши преимущества:

- Оперативные поставки широкого спектра электронных компонентов отечественного и импортного производства напрямую от производителей и с крупнейших мировых складов;
- Поставка более 17-ти миллионов наименований электронных компонентов;
- Поставка сложных, дефицитных, либо снятых с производства позиций;
- Оперативные сроки поставки под заказ (от 5 рабочих дней);
- Экспресс доставка в любую точку России;
- Техническая поддержка проекта, помощь в подборе аналогов, поставка прототипов;
- Система менеджмента качества сертифицирована по Международному стандарту ISO 9001;
- Лицензия ФСБ на осуществление работ с использованием сведений, составляющих государственную тайну;
- Поставка специализированных компонентов (Xilinx, Altera, Analog Devices, Intersil, Interpoint, Microsemi, Aeroflex, Peregrine, Syfer, Eurofarad, Texas Instrument, Miteq, Cobham, E2V, MA-COM, Hittite, Mini-Circuits, General Dynamics и др.);

Помимо этого, одним из направлений компании «ЭлектроПласт» является направление «Источники питания». Мы предлагаем Вам помощь Конструкторского отдела:

- Подбор оптимального решения, техническое обоснование при выборе компонента;
- Подбор аналогов;
- Консультации по применению компонента;
- Поставка образцов и прототипов;
- Техническая поддержка проекта;
- Защита от снятия компонента с производства.



#### Как с нами связаться

**Телефон:** 8 (812) 309 58 32 (многоканальный)

**Факс:** 8 (812) 320-02-42

**Электронная почта:** [org@eplast1.ru](mailto:org@eplast1.ru)

**Адрес:** 198099, г. Санкт-Петербург, ул. Калинина, дом 2, корпус 4, литера А.