

## Description

Single pole, miniaturised, aircraft style thermal circuit breaker with tease-free, trip-free, snap action mechanism and push/pull on/off manual actuation (M-type TO CBE to EN 60934). An indicator band on the push button clearly shows the tripped/off position. Threadneck panel mounted, available in metric and US (MS 3320) configurations. Advanced two-chamber design contributes to fail-safe operation. Temperature compensated from -55 °C to +125 °C, with optional auxiliary contacts, and fully approved for use on a wide range of aircraft and equipment. Full specification ensures suitability for the most demanding applications. For three pole version see type 583.

## Typical applications

Aircraft systems and equipment (fixed wing and helicopters); other extra low voltage wiring applications; defence equipment; communications systems.

## Standard current ratings and typical volt drop values

Current rating (A)	Volt drop (mV)	Current rating (A)	Volt drop (mV)
1	750	10	190
2	520	15	190
2.5	400	20	200
3	360	25	170
4	350	30	160
5	260	35	150
7.5	230		

## Approvals

Authority	Standard	Rated voltage	Current ratings
UL	UL 1077	AC 250 V DC 75 V	1 A...25 A 1 A...35 A
CSA	C22.2 No 235	AC 250 V DC 75 V	1 A...25 A 1 A...35 A
Bw	VG 95345, part 6	AC 115 V, 400 Hz DC 28 V	1 A...25 A 1 A...25 A
Bw	LN 29886	AC 115 V, 400 Hz DC 28 V	1 A...25 A 1 A...25 A
QPL Canada Dep. of National Defence	VG 95345, part 6	AC 115 V, 400 Hz DC 28 V	1 A...25 A 1 A...25 A
QPL Sweden Defence Material Admin.	LN 29886 MS 3320	AC 115 V, 400 Hz DC 28 V	1 A...25 A 1 A...25 A
QPL UK Ministry of Defence	LN 29886	AC 115 V, 400 Hz DC 28 V	1 A...25 A 1 A...25 A
Dep. of the Navy	MS 3320 (V)	AC 115 V, 400 Hz DC 28 V	1 A...20 A 1 A...20 A



## Technical data

For further details please see: [www.e-t-a.de/ti\\_e](http://www.e-t-a.de/ti_e)

Voltage rating	AC 115 V (300 Hz to 800 Hz); DC 28 V (higher voltage ratings upon request)	
Current rating range	1...35 A	
Auxiliary circuit	0.5 A, DC 28 V	
Typical life	20,000 operations mechanical or 10,000 operations at $I_N (\leq 25 \text{ A})$ 5,000 operations at $I_N (30 + 35 \text{ A})$	
Ambient temperature	-55...+125 °C (-67...+257 °F)	
Insulation co-ordination (IEC 60664 and 60664A)	rated impulse withstand voltage 1.5 kV	pollution degree 3
Dielectric strength (IEC 60664 and 60664A)	test voltage operating area main to aux. circuit	AC 1,500 V AC 1,500 V
Insulation resistance	> 100 MΩ (DC 500 V)	
Interrupting capacity $I_{cn}$	AC 115 V (400 Hz): 5 A      2,000 A 7.5...35 A      2,500 A DC 28 V: 1...25 A      6,000 A 30 + 35 A      4,000 A	
Degree of protection (IEC 60529/DIN 40050)	operating area IP40 terminal area IP00	
Vibration (sinusoidal)	15 g (70-2000 Hz), ± 0.76 mm (5-70 Hz) to VG 95210, sheet 19, IEC 60068-2-6, test Fc/ISO 7137	
Vibration (random)	16.4 g rms, 0.2 g <sup>2</sup> /Hz ± 1.5 dB to VG 95210, sheet 29, ISO 7137	
Acceleration	17 g, to ISO 2669	
Shock	75 g (11 ms) to VG 95210, sheet 28, IEC 60068-2-27, test Ea/ISO 7137	
Corrosion	96 hours at 5 % salt mist, severity A 48 hours at 20 % salt mist, severity B to VG 95210, sheet 2, IEC 60068-2-11, test Ka/ISO 7137	
Humidity	240 hours at 95 % RH, to VG 95210, sheet 7, IEC 60068-2-3, test C/ISO 7137	
Explosion	to VG 95210, sheet 10, MIL-STD-202, meth. 109	
Altitude	≤ 25,000 m above sea level	
Mass	max. 29 g with auxiliary contact max. 25 g without auxiliary contact	

**Weight reduction through aluminium threadneck: approx. 3 g**

## Ordering information

<b>Type No.</b>	
483	single pole, with temperature compensation
<b>Mounting</b>	
G	threadneck panel mounting, standard
<b>Threadneck design</b>	
1	M12x1x6.4x8.8 dia. with mounting plate (aux. contact version)
3	MJ12x6.4x8.8 dia. (without aux. contact)
4	M12x1x6.4x8.8 dia. (without aux. contact)
5	7/16-32UNx6.4x7.8 dia. (without aux. contact)
6	M12x1x9.4x8.8 dia. (without aux. contact)
<b>Hardware for threadneck (washers)</b>	
0	without hardware
1	wave washer 12/15 - mounted
2	mounted washer 12.1/17.2 - mounted
3	mounted washer 11.3/14.9 - mounted (threadneck design 5,7 only)
<b>Hardware for threadneck (nuts)</b>	
0	without hardware
1	hex nut M12x1 (threadneck design 1, 4, 6 only)
3	hex nut 7/16-32UN (threadneck design 5, 7 only)
4	hex nut M12x1, aluminium, fitted (threadneck design 8 only)
5	hex nut MJ12x1 (only with threadneck design 3)
<b>Terminal design (main terminals)</b>	
<b>K</b> screws terminals with metric thread	
1	K14 (M4, MJ4)
<b>J</b> screw terminals with inch thread	
1	J14 (8-32UNC-2B)
2	J17 (8-32UNC-2B)
3	J25 (6-32UNC-2B)
<b>Characteristic curve</b>	
M1	thermal, 1.15-1.38 I <sub>N</sub>
<b>Terminal screws</b>	
A	Phillips screw M4x6
B	Phillips screw 8-32UNC-2Ax6 (MS 51957-41)
C	Phillips screw 6-32UNC-2Ax6 (MS 51957-26)
D	slotted flat head screw M4x6
E	hex screw with Phillips head 8-32UNC-3A-9.5
L	Phillips screw MJ4x6
Z	without accessories
<b>Terminal washers</b>	
0	without lock washer
1	lock washer B4
2	lock washer 4.3 (MS 35338-137)
4	lock washer 3.7 (MS 35338-136)
<b>Auxiliary contact</b>	
S0	without auxiliary contact
S1	with auxiliary contact (N/C) connector to EN3155-016M2018, size 20
S5	with polarized auxiliary contact (N/C)
<b>Barrier</b>	
Z	without barrier (standard)
<b>Colour of the push button</b>	
blank: black (standard) (e. g. 7.5)	
N	black, marking to EN (e. g. 7 1/2)
<b>Current ratings</b>	
1...35 A	
483 - G 4 1 1 - K 1 M1 - A 1 S0 Z . - 5 A ordering example	

Please be informed that we have minimum ordering quantities to be observed.

## Ordering information for approved devices

### 483-G411-K1M1-A1S0ZN

Metric threadneck M12x1 and terminal design -K14 (M4x6), listed by the German Materialamt der Bundeswehr to VG 95345 T06.

### 483-G533-J1M1-B2S0ZN (MS 3320)

Threadneck size 7/16-32UNSx6.4 and terminal design -J14 (inch thread 8-32), approved to MS 3320.

### 483-G533-J3M1-C4S0Z (483-TC-G11-J25)

Threadneck size 7/16-32UNSx6.4 and terminal design -J25 (inch thread 6-32), listed by the German Materialamt der Bundeswehr to VG 95345, part 6.

## Internal connection diagrams

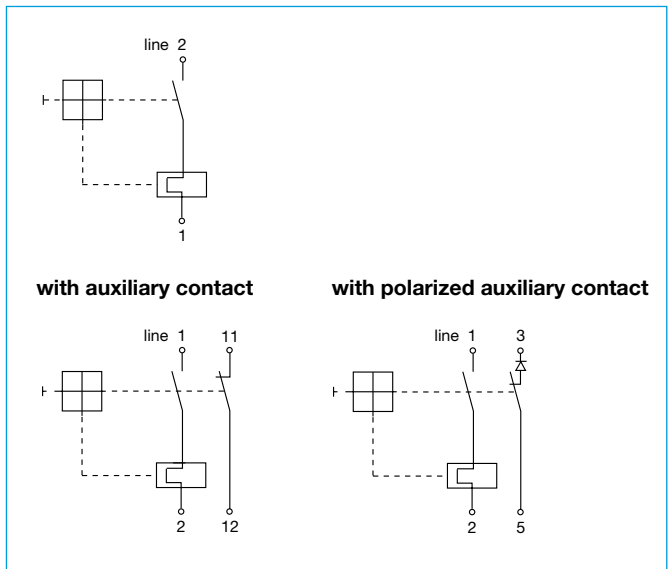

with auxiliary contact

with polarized auxiliary contact

## Preferred types

Preferred types	Standard current ratings (A)												
	1	2	2.5	3	5	6	7.5	10	15	20	25	30	35
483-G411-K1M1-A1S0Z-	x	x	x	x	x	x	x	x	x	x	x	x	x
483-G411-K1M1-A1S0ZN- (VG 95345 T06)	x	x	x	x	x	x	x	x	x	x	x	x	x

## Dimensions 483-G411-K1M1-A1S0ZN (VG 95345 T06)



## Dimensions 483-G111-K1M1-A1S1ZN (VG 95345 T06)



## Dimensions 483-G533-J1M1-B2S0ZN (MS 3320)



## Mounting



This is a metric design and millimeter dimensions take precedence (mm/inch)

1

## Other main terminal and threadneck designs

### Terminal design -J2

Terminal distances to:

- MS 14 105 (a, b)
- MS 14 153 (a, b)
- MS 22 073 (a)
- MS 22 074 (a)
- MS 25 244 (a)
- MS 25 373 (a, b)

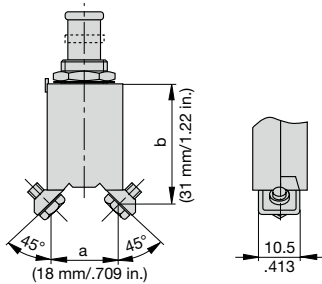

### Terminal design -J3

Terminal distances to:

- MS 26 574 (a, b)

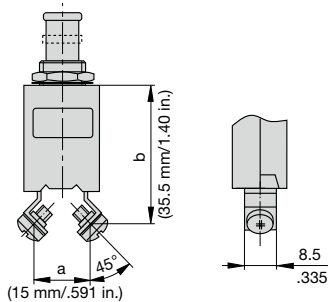

### Mounting -G6

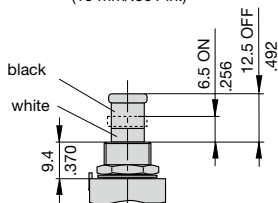

## Accessories

Identification collar to be snapped on the push button

- Y 307 004 01 black
- Y 307 004 02 white
- Y 307 004 03 red
- Y 307 004 04 green
- Y 307 004 05 blue

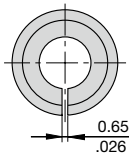
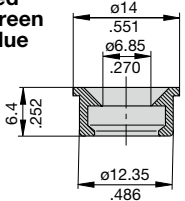

Lock out ring to block the push button in OFF position

- Y 307 005 01 red
- Y 307 005 02 black

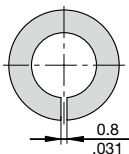
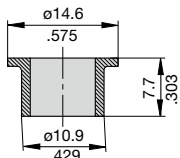

## Typical time/current characteristics

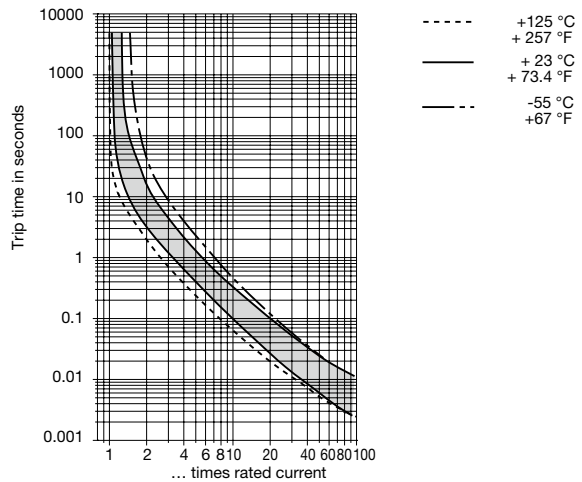

## Accessories

Splash cover/hex nut assembly with O ring (IP66 and IP67)

(approved to VG 95345, T23)

- X 200 801 08 nickel plated nut, transparent cover
- X 200 801 03 matt black finish nut, black cover
- X 200 801 09 matt black finish nut 7/16-32, black cover
- X 200 801 12 with blackened nut and transparent cover

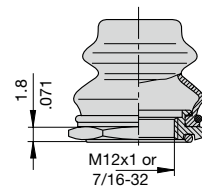

Splash cover/hex nut assembly with O ring (IP54)

(approved to VG 95345, T23)

- X 200 802 01 nickel plated nut
- X 200 802 02 matt black finish nut

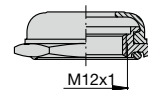

Actuator extension (black) to be fitted on the push button

(approved to VG 95345, T23)

- X 200 803 01

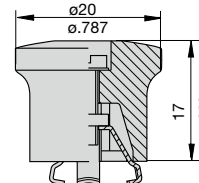

This is a metric design and millimeter dimensions take precedence ( $\frac{\text{mm}}{\text{inch}}$ )

All dimensions without tolerances are for reference only. In the interest of improved design, performance and cost effectiveness the right to make changes in these specifications without notice is reserved. Product markings may not be exactly as the ordering codes. Errors and omissions excepted.



Компания «ЭлектроПласт» предлагает заключение долгосрочных отношений при поставках импортных электронных компонентов на взаимовыгодных условиях!

Наши преимущества:

- Оперативные поставки широкого спектра электронных компонентов отечественного и импортного производства напрямую от производителей и с крупнейших мировых складов;
- Поставка более 17-ти миллионов наименований электронных компонентов;
- Поставка сложных, дефицитных, либо снятых с производства позиций;
- Оперативные сроки поставки под заказ (от 5 рабочих дней);
- Экспресс доставка в любую точку России;
- Техническая поддержка проекта, помощь в подборе аналогов, поставка прототипов;
- Система менеджмента качества сертифицирована по Международному стандарту ISO 9001;
- Лицензия ФСБ на осуществление работ с использованием сведений, составляющих государственную тайну;
- Поставка специализированных компонентов (Xilinx, Altera, Analog Devices, Intersil, Interpoint, Microsemi, Aeroflex, Peregrine, Syfer, Eurofarad, Texas Instrument, Miteq, Cobham, E2V, MA-COM, Hittite, Mini-Circuits, General Dynamics и др.);

Помимо этого, одним из направлений компании «ЭлектроПласт» является направление «Источники питания». Мы предлагаем Вам помощь Конструкторского отдела:

- Подбор оптимального решения, техническое обоснование при выборе компонента;
- Подбор аналогов;
- Консультации по применению компонента;
- Поставка образцов и прототипов;
- Техническая поддержка проекта;
- Защита от снятия компонента с производства.



#### Как с нами связаться

**Телефон:** 8 (812) 309 58 32 (многоканальный)

**Факс:** 8 (812) 320-02-42

**Электронная почта:** [org@eplast1.ru](mailto:org@eplast1.ru)

**Адрес:** 198099, г. Санкт-Петербург, ул. Калинина, дом 2, корпус 4, литера А.