

# Amphenol® RF

RF Solutions for the Telematics Market



## FAKRA SMB Connectors

Version 3.0

## Contents

|  |       |
|--|-------|
| Introduction to FAKRA . . . . .              | 1     |
| Product Overview . . . . .                   | 2     |
| Specifications                               |       |
| FAKRA/USCAR Product Specifications . . . . . | 3     |
| Plug Keying Options . . . . .                | 4     |
| Jack Keying Options . . . . .                | 4     |
| Dual Housings . . . . .                      | 4     |
| Part Numbering System . . . . .              | 5     |
| Mechanical and Color Coding . . . . .        | 5     |
| Cable Assembly Codes . . . . .               | 6     |
| Special Codes . . . . .                      | 6     |
| FAKRA Plug Interface . . . . .               | 7     |
| FAKRA Jack Interface . . . . .               | 8     |
| <hr/>  |       |
| Cable Connectors GEN 1.0                     |       |
| Straight Plugs . . . . .                     | 9     |
| Straight Jacks . . . . .                     | 10    |
| Right Angle Jacks . . . . .                  | 10    |
| Cable Connectors: GEN 2.0                    |       |
| Straight Plugs . . . . .                     | 11    |
| Straight Jacks . . . . .                     | 11-12 |
| Right Angle Jacks . . . . .                  | 12    |
| 3-Way Plugs . . . . .                        | 13    |
| 3-Way Jacks . . . . .                        | 13    |
| Cable Connectors: GEN 2.5                    |       |
| Straight Plugs . . . . .                     | 14    |
| Straight Jacks . . . . .                     | 14    |
| <hr/>  |       |
| PCB Connectors: GEN 1.0                      |       |
| Straight Plugs . . . . .                     | 15    |
| Edgemount Plugs . . . . .                    | 15    |
| Right Angle Plugs . . . . .                  | 15    |
| PCB Connectors: GEN 2.0                      |       |
| Edgemount Plugs . . . . .                    | 16    |
| Right Angle Plugs . . . . .                  | 16    |
| Dual Jacks . . . . .                         | 16    |
| 8mm Plugs . . . . .                          | 17    |
| <hr/>  |       |
| Termination Tooling . . . . .                | 18    |
| Concepts . . . . .                           | 19    |



Male = Plug  
Female = Jack

**Meets USCAR 2, 17 and 18**

## RF Solutions for the Automotive Market

### Introduction

The automotive industry has been revolutionized with the increased adoption of telematics in vehicles including GPS, Cellular, Bluetooth and Satellite Radio. No longer are satellite navigation systems and sophisticated in-vehicle entertainment confined solely to the luxury end of the market.

As telematic advancements become more reliable, available and inexpensive, vehicles are transforming into an intelligent platform for enabling mobile life. With these recent advancements in communications technology and increased consumer demand for a diverse array of on-board telematics services, RF communications systems have become integral components of today's automobile, trucking, watercraft, motorcycle and off-road construction markets.

To keep RF interconnection costs low, and to ensure high levels of electrical and mechanical performance for telematics applications, such as Global Positioning Satellite, Satellite Radio, Vehicular Internet Access, Remote vehicle diagnostics and Bluetooth, the worldwide automotive industries have standardized a high-performing, cost-effective RF connector based on the FAKRA and USCAR standards.

Utilizing a modified metal SMB connector embedded within a plastic housing that can be designed with multiple color codes for easy identification, FAKRA connectors are designed to perform up to 6 GHz and meet the particular mechanical and environmental requirements of the automotive industry. Amphenol RF also offers a variety of connectors for board-to-board, PCB interfaces, and traditional antenna interfaces.

### Technologies Supported

**AM/FM Radio:** Antenna technology that supports GPS and Satellite Radio is the same antenna that will support AM/FM radio. This combined antenna capability not only reduces the number of external antennas on the vehicles, but offers standardization among the interconnects.

**Satellite Radio:** Originating at a broadcast center, the broadcast signal is beamed from earth-station antennas to broadcast satellites. These satellites don't move and are positioned more than 22,000 miles above the earth in geo-stationary orbit. Their beams combine to span the entire contiguous U.S. while remaining stationary with respect to the land below.

**GPS** (Global Positioning System): A worldwide MEO satellite navigational system formed by 24 satellites orbiting the earth and their corresponding receivers on the earth. The GPS satellites continuously transmit digital radio signals that contain data on the satellites' location and the exact time to the earth-bound receivers.

**Cellular/PCS** (Personal Communications Service): the U.S. Federal Communications Commission (FCC) term used to describe a set of digital cellular technologies being deployed in the U.S. It is also referred to as digital cellular.

**Bluetooth:** A short-range radio technology aimed at simplifying communications among Internet devices, between devices and the Internet. It also aims to simplify data synchronization between Internet devices and other computers.

**Wireless Remote:** Remote starting, remote keyless entry and door/window controls are all supported by our FAKRA products.

**Vehicle Controls:** Adaptive Cruise Control, Collision Avoidance Systems and DSRC (Dedicated Short Range Communications) are all evolving technologies that utilize FAKRA.

**WiFi:** Many new automotive models are incorporating WiFi in to their Infotainment offerings. Our FAKRA connectors support this emerging technology.

# Product Overview

## FAKRA Generation 1.0, 2.0, and 2.5

### Product Overview

#### GENERATION 1.0

FAKRA Generation 1.0 utilizes a modified metal SMB connector embedded within a plastic housing unit for ease of identification and assembly. These plastic housings are designed with visually and mechanically coded and keyed tooling to eliminate assembly errors. Our standard FAKRA connectors are designed to perform up to 6 GHz and meet the electrical, mechanical and environmental standards of the automotive industry. Generation 1.0 typically features five separate component parts.

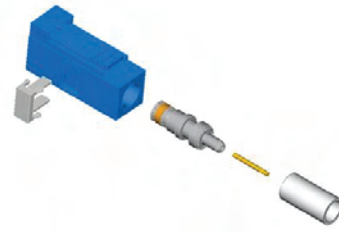

#### GENERATION 2.0

FAKRA Generation 2.0 offers reduced installation costs for our customers via a pre-assembled housing unit. This pre-assembled housing eliminates two loose components and their associated assembly and handling costs. Due to this component reduction, Generation 2.0 features three separate components to install versus Generation 1.0's five separate components.

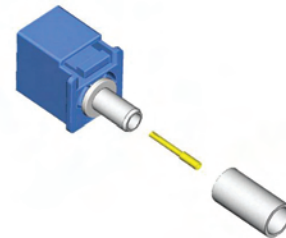

#### GENERATION 2.5

FAKRA Generation 2.5 offers the same pre-assembled housing units and design improvements as Generation 2.0, but center contacts are provided on a tape and reel for automated distribution and placement.

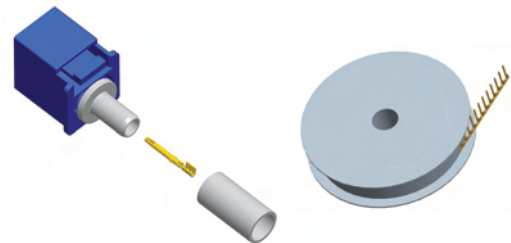

## Cable Assembly Instructions

For your convenience and to insure that you have the latest information, cable assembly instructions are available online at [www.amphenorlf.com](http://www.amphenorlf.com). Simply type in the cable assembly instruction number given with each part number and you will be directed to the correct cable assembly instruction.

## FAKRA / USCAR Product Specifications

**ELECTRICAL**

|                                 |                         |   |
|---------------------------------|-------------------------|---|
| Impedance                       |                         | 50 $\Omega$ nominal                                 |
| Frequency Range                 |                         | DC - 6 GHz (optimized for DC - 4 GHz)               |
| Performance Spec                |                         |   |
| V.S.W.R                         |                         | DC - 2 GHz    2 GHz - 4 GHz                         |
|                                 | <i>spec requirement</i> | 1.40 max    1.50 max                                |
| Insertion Loss                  | <i>spec requirement</i> | $\leq$ 0.3 dB max from DC - 3 GHz                   |
| Insulation Resistance           |                         | 1000 M $\Omega$ min                                 |
| Contact Resistance              | <i>center contact</i>   | $<$ 40 m $\Omega$                                   |
|                                 | <i>outer contact</i>    | $<$ 40 m $\Omega$                                   |
| Dielectric Withstanding Voltage | <i>at sea level</i>     | $>$ 800 VRMS (Interface only; may be cable limited) |

**MECHANICAL**

|                                       |  |                                   |
|---------------------------------------|--|-----------------------------------|
| Durability (matings)                  |  | 100 min                           |
| Plastic Housing - Engagement Force    |  | $\leq$ 40 N (Single FAKRA)        |
| Plastic Housing - Disengagement Force |  | $\geq$ 35 N (Single FAKRA)        |
| Cable Retention Force                 |  | $\geq$ 110 N                      |
| Coding                                |  | 14 mechanical and colored codings |
| Interface                             |  | USCAR-18, DIN                     |

**ENVIRONMENTAL**

|                   |                  |   |
|-------------------|------------------|---|
| Temperature Range | <i>operating</i> | -40 / +100° C   |
| Thermal Shock     |                  | MIL-STD-202, Method 107, Cond B<br>(-55 / +125° C) or USCAR-2, para 5.6.1       |
| Vibration         |                  | MIL-STD-202, Method 204, Cond B;<br>(15g) or USCAR-2, para 5.4.6                |
| Shock             |                  | MIL-STD-202, Method 213, Cond B<br>(75g, 6 ms, 1/2 sine) or USCAR-2, para 5.4.6 |

**MATERIALS**

|  |                      |                                     |
|--|----------------------|-------------------------------------|
| Plastic Housing                        | <i>jacks</i>         | Nylon, PBT or PPE                   |
|  | <i>in-line plugs</i> | Nylon or PBT                        |
|  | <i>PCB plugs</i>     | Nylon                               |
| Secondary Locking Clip (if applicable) |                      | PBT                                 |
| Center Contact                         | <i>jack</i>          | Beryllium Copper or Phosphor Bronze |
|  | <i>plug</i>          | Brass or Phosphor Bronze            |
| Body                                   |                      | Brass, Zinc Alloy                   |
| Retainer Ring (if applicable)          |                      | Beryllium Copper                    |
| Ferrule                                |                      | Copper Alloy                        |
| Insulator                              |                      | TFE or TPX                          |

**PLATING**

|                |                     |                   |
|----------------|---------------------|-------------------|
| Center Contact |                     | Gold              |
| Body           | <i>cable types</i>  | Nickel            |
|                | <i>solder types</i> | Nickel, Gold, Tin |
| Ferrule        |                     | Nickel            |

# Specifications

## Plug Keying Options

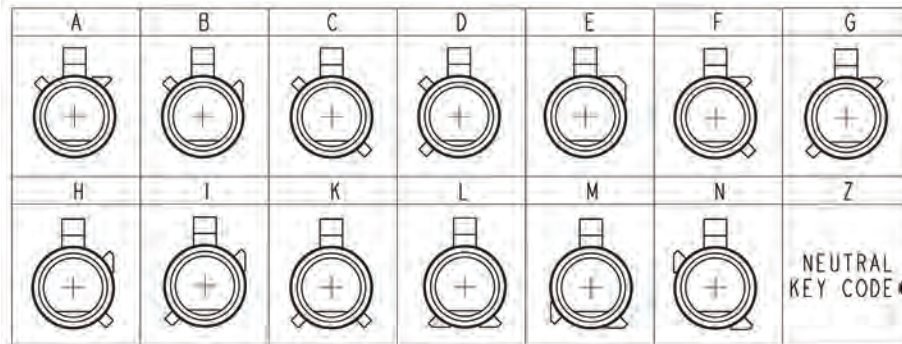

\* "Z" or neutral key code is available that mates with the majority of FAKRA connections. Consult factory for intermateability options.

## Jack Keying Options

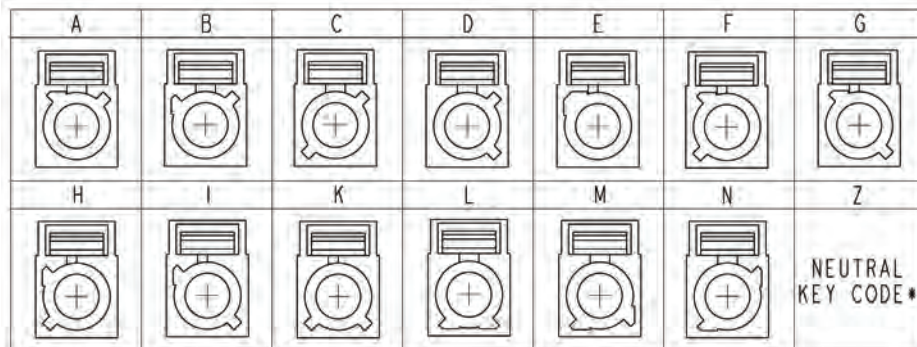

\* "Z" or neutral key code is available that mates with the majority of FAKRA connections. Consult factory for intermateability options.

## Dual Housings

**Dual Housing**  
(Refer to Plug/Jack Keying for key options)

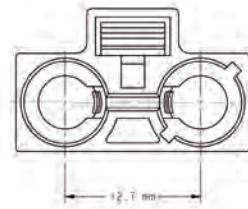
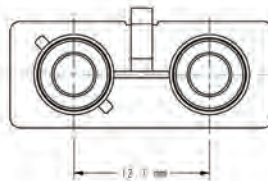

**Dual - 8mm (High-Density) Housing**  
(Refer to Plug/Jack Keying for key options)

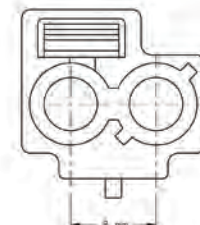
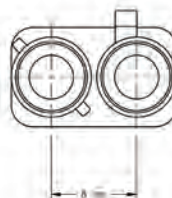

**Amphenol RF Part Numbering System**

| Single and Dual Products |   |   |              |                                   |                 |          |            |                          |   |                                      |         |   |   |   |
|--------------------------|---|---|--------------|-----------------------------------|-----------------|----------|------------|--------------------------|---|--------------------------------------|---------|---|---|---|
| X                        | F | A | X            | -                                 | X               | X        | X          | X                        | - | X                                    | X       | X | - | # |
| Series                   |   |   | Tab Location | Keying Codes                      | Style           | Gender   | Attachment |                          |   | " - " (standard)<br>S (reel contact) | Special |   |   |   |
| Blank (Gen 1.0)          |   |   | 1 (Single)   | N (North)                         | S (Straight)    | P (Plug) | C          | Cable Group<br>see chart |   |                                      |         |   |   |   |
| 2 (Gen 2.0 & 2.5)        |   |   | 2 (Dual)     | S (South)<br>E (East)<br>W (West) | R (Right Angle) | J (Jack) | P          | C                        | B |                                      |         |   |   |   |

| 3-Way Product |   |   |   |                      |  |                      |        |                  |                         |         |   |
|---------------|---|---|---|----------------------|--|----------------------|--------|------------------|-------------------------|---------|---|
| 2             | F | A | 3 | X                    | X  | X                    | X      | X                | -                       | X       | X |
| Series        |   |   |   | - (Plug)<br>D (Jack) | Cable type                               |                      | Gender | Factory Assigned | Key Code<br>(see chart) | Special |   |
|               |   |   |   |                      | 1 (Cable Group 01)<br>4 (Cable Group 04) | P (Plug)<br>J (Jack) |        |                  |                         |         |   |

**Mechanical and Color Coding**

| Coding | Rib Combination | Color          | RAL no. |
|--------|-----------------|----------------|---------|
| A      | A - B1          | Jet Black      | 9005    |
| B      | A - B2          | Cream          | 9001    |
| C      | A - C           | Signal Blue    | 5005    |
| D      | A - D           | Claret Violet  | 4004    |
| E      | B1 - B2         | Leaf Green     | 6002    |
| F      | B1 - C          | Nut Brown      | 8011    |
| G      | B1 - D          | Blue Grey      | 7031    |
| H      | B2 - C          | Heather Violet | 4003    |
| I      | B2 - D          | Beige          | 1001    |
| K      | C - D           | Curry          | 1027    |
| L      | H - J1          | Carmine Red    | 3002    |
| M      | H - J2          | Pastel Orange  | 3003    |
| N      | H - G1          | Pastel Green   | 6019    |
| Z      | Neutral Coding  | Water Blue     | 5021    |

# Specifications

| Cable Assembly Codes |                                  |                               |                        |                  |
|----------------------|----------------------------------|-------------------------------|------------------------|------------------|
| **                   | Cable Types                      | Center Contact (mm/inches)    | Dielectric (mm/inches) | O.D. (mm/inches) |
| 00                   | RG-58/RG-174 Combo Design        | Reference C01 and C04 (below) |                        |                  |
| 01                   | RG-174, 188, 316                 | 0.536 / 0.0211                | 1.600 / 0.0630         | 3.200 / 0.1260   |
| 04                   | RG-58, 141                       | 1.020 / 0.0402                | 3.070 / 0.1209         | 5.054 / 0.1990   |
| 05                   | 1.5DS-QEHV                       | 0.540 / 0.0213                | 1.670 / 0.0660         | 3.500 / 0.1378   |
| 07                   | 1.5DS-GXC-SP                     | 0.630 / 0.0248                | 1.670 / 0.0660         | 3.200 / 0.126    |
| 10                   | RG-178, 196 Type                 | 0.330 / 0.0130                | 0.941 / 0.0370         | 1.905 / 0.0750   |
| 62                   | 5P3-46B                          | 0.510 / 0.0201                | 3.200 / 0.1260         | 5.106 / 0.2010   |
| 65                   | RG-59, 62 Type                   | 0.570 / 0.0224                | 3.850 / 0.1516         | 6.350 / 0.2500   |
| 71                   | RG-71 / U M (Ford)               | 0.340 / 0.0134                | 3.840 / 0.1512         | 6.400 / 0.2520   |
| 99                   | RG-59 Type / RG-174 Combo Design | Reference C01 and C65 (above) |                        |                  |

| # | Special Codes (Plug)               |
|---|------------------------------------|
| 0 | Standard Bracket (single and dual) |
| 1 | Single In-Line                     |
| 9 | Dual In-Line                       |
| X | Special Bracket                    |

| # | Special Codes (Jack)   |
|---|------------------------|
| 0 | Standard               |
| 3 | 360° Design (R/A only) |
| 6 | Clip provision at 180° |

| #   | Special Codes (Plug PCB)             |
|---|--------------------------------------|
| 0   | Edgemount                            |
| 1   | Edgemount w/Support Legs             |
| 2   | Vertical Mount                       |
| 6   | Right Angle (Gold)                   |
| 8   | Right Angle (Tin)                    |
| M   | Right Angle Die Cast (metal housing) |
| S   | Right Angle Stamped & Formed         |
| X   | Edgemount Pin & Paste                |
| Note: For the -6 & -8, add an "A" to the end for assembled part w/housing |                                      |

Cable Assembly Instructions are available online at [www.amphenolrf.com](http://www.amphenolrf.com). Consult factory for available keying codes.



FAKRA Plug Interface

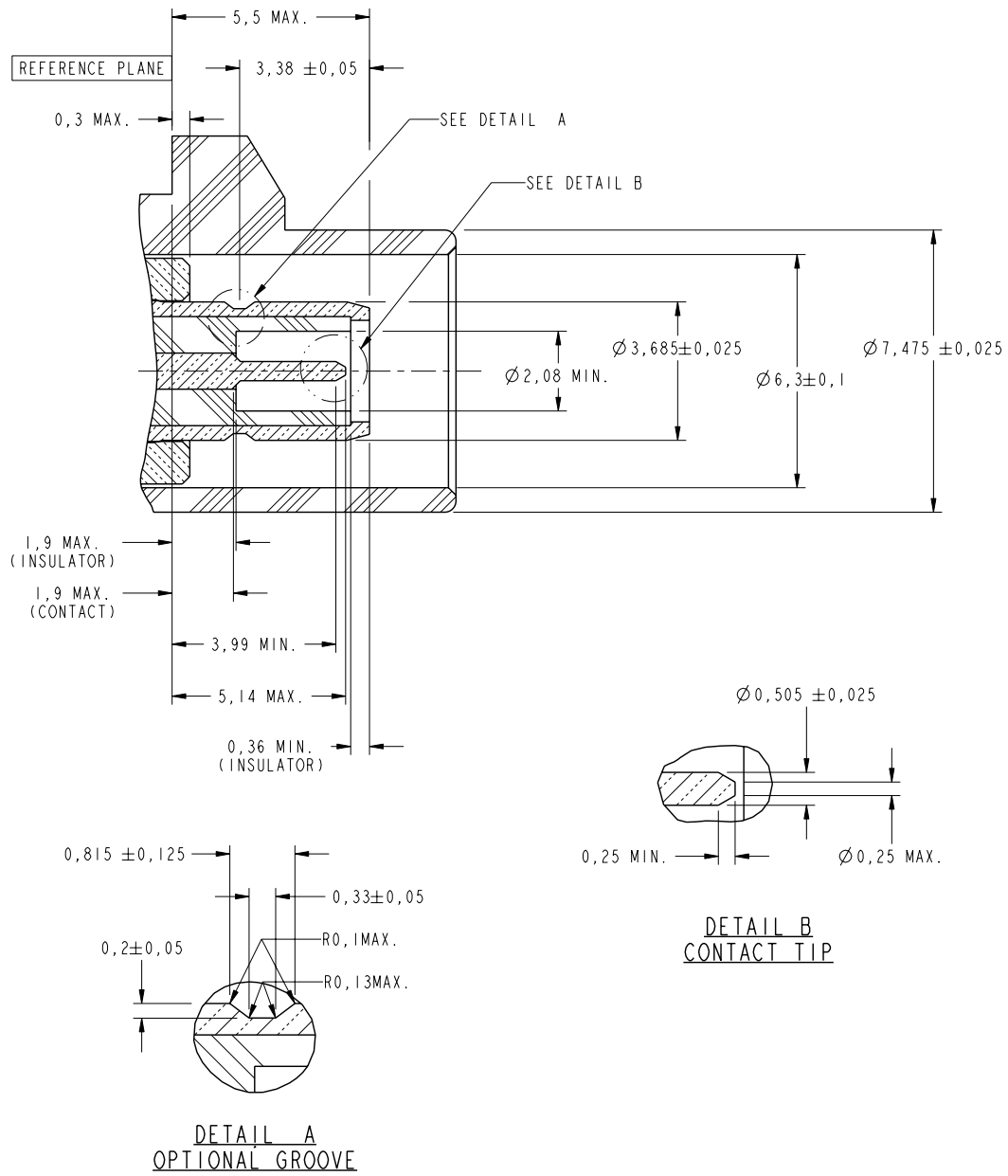

## FAKRA Jack Interface

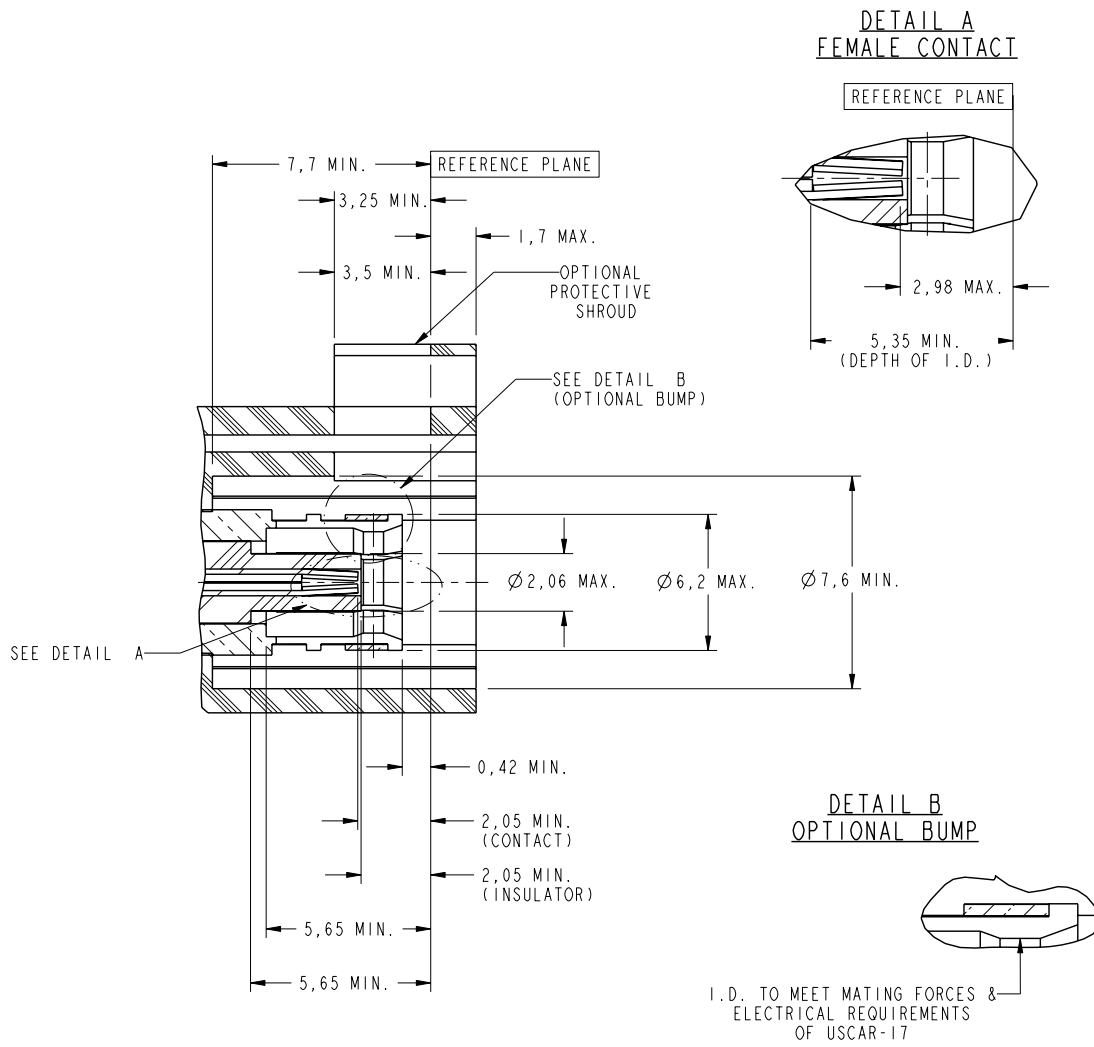



## Straight Plugs



### Single - Panel Mount

| Part Number    | Cable Group | Cable Assembly Instructions |
|----------------|-------------|-----------------------------|
| FA1-NXSP-C01-5 | 01          | 349-50784                   |



### Single

| Part Number    | Cable Group | Cable Assembly Instructions |
|----------------|-------------|-----------------------------|
| FA1-NXSP-C01-1 | 01          | 349-50781                   |
| FA1-NXSP-C04-1 | 04          | 349-50781                   |
| FA1-NXSP-C62-1 | 62          | 349-50781                   |



### Single w/Bracket

| Part Number    | Cable Group | Cable Assembly Instructions |
|----------------|-------------|-----------------------------|
| FA1-NXSP-C01-0 | 01          | 349-50781                   |
| FA1-NXSP-C04-0 | 04          | 349-50781                   |



### Dual

| Part Number    | Cable Group | Cable Assembly Instructions |
|----------------|-------------|-----------------------------|
| FA2-NXSP-C00-9 | 00          | 349-50781                   |
| FA2-NXSP-C01-9 | 01          | 349-50781                   |
| FA2-NXSP-C04-9 | 04          | 349-50781                   |



### Dual w/Bracket

| Part Number    | Cable Group | Cable Assembly Instructions |
|----------------|-------------|-----------------------------|
| FA2-NXSP-C00-0 | 00          | 349-50781                   |
| FA2-NXSP-C04-0 | 04          | 349-50781                   |
| FA2-NXSP-C10-0 | 10          | 349-50781                   |



### Combo (2 singles) w/Bracket

| Part Number     | Cable Group | Cable Assembly Instructions |
|-----------------|-------------|-----------------------------|
| FC2-NCDSP-C00-0 | 00          | 349-50781                   |



### Combo (2 singles)

| Part Number     | Cable Group | Cable Assembly Instructions |
|-----------------|-------------|-----------------------------|
| FC2-NEKSP-C01-X | 01          | 349-50781                   |

Cable Assembly Instructions are available online at [www.amphenorlf.com](http://www.amphenorlf.com). Consult factory for available keying codes.



## Cable Connectors: GEN 1.0

### Straight Jacks



#### Single

| Part Number    | Cable Group | Cable Assembly Instructions |
|----------------|-------------|-----------------------------|
| FA1-NXSJ-C01-0 | 01          | 349-50782                   |
| FA1-NXSJ-C04-0 | 04          | 349-50782                   |
| FA1-NXSJ-C07-0 | 07          | 349-50782                   |
| FA1-NXSJ-C10-0 | 10          | 349-50782                   |
| FA1-NXSJ-C62-0 | 62          | 349-50782                   |



#### Single w/Clip Slot Provision

| Part Number    | Cable Group | Cable Assembly Instructions |
|----------------|-------------|-----------------------------|
| FA1-NXSJ-C01-6 | 01          | 349-50782                   |
| FA1-NXSJ-C04-6 | 04          | 349-50782                   |



#### Dual

| Part Number    | Cable Group | Cable Assembly Instructions |
|----------------|-------------|-----------------------------|
| FA2-NXSJ-C00-0 | 00          | 349-50782                   |
| FA2-NXSJ-C01-0 | 01          | 349-50782                   |
| FA2-NXSJ-C04-0 | 04          | 349-50782                   |



#### Dual w/Clip Slot Provision

| Part Number    | Cable Group | Cable Assembly Instructions |
|----------------|-------------|-----------------------------|
| FA2-NXSJ-C00-6 | 00          | 349-50782                   |
| FA2-NXSJ-C01-6 | 01          | 349-50782                   |
| FA2-NXSJ-C04-6 | 04          | 349-50782                   |

### Right Angle Jacks



#### Single R/A

| Part Number    | Cable Group | Cable Assembly Instructions |
|----------------|-------------|-----------------------------|
| FA1-NXRJ-C01-0 | 01          | 349-50783                   |
| FA1-NXRJ-C04-0 | 04          | 349-50783                   |

Cable Assembly Instructions are available online at [www.amphenorlf.com](http://www.amphenorlf.com). Consult factory for available keying codes.



**Straight Plugs**



**Single**

| Part Number     | Cable Group | Cable Assembly Instructions |
|-----------------|-------------|-----------------------------|
| 2FA1-NXSP-C01-1 | 01          | 349-50695                   |
| 2FA1-NXSP-C04-1 | 04          | 349-50695                   |
| 2FA1-NXSP-C65-1 | 65          | 349-50695                   |
| 2FA1-NXSP-C71-1 | 71          | 349-50695                   |



**Dual - 8mm (High Density)**

| Part Number w/Contact | w/o Contact | Cable Group | Cable Assembly Instructions |
|-----------------------|-------------|-------------|-----------------------------|
| 2FAH-NXSP-C00-9       | C00W9       | 00          | 349-50767                   |
| C01-9                 | C01W9       | 01          | 349-50767                   |
| C04-9                 | C04W9       | 04          | 349-50767                   |
| C62-9                 | C62W9       | 62          | 349-50767                   |
| C99-9                 | C99W9       | 99          | 349-50767                   |



**Dual**

| Part Number     | Cable Group | Cable Assembly Instructions |
|-----------------|-------------|-----------------------------|
| 2FA2-NXSP-C00-9 | 00          | 349-50695                   |
| 2FA2-NXSP-C01-9 | 01          | 349-50695                   |
| 2FA2-NXSP-C04-9 | 04          | 349-50695                   |

**Straight Jacks**



**Single**

| Part Number     | Cable Group | Cable Assembly Instructions |
|-----------------|-------------|-----------------------------|
| 2FA1-NXSJ-C01-0 | 01          | 349-50713                   |
| 2FA1-NXSJ-C04-0 | 04          | 349-50713                   |
| 2FA1-NXSJ-C62-0 | 62          | 349-50713                   |
| 2FA1-NXSJ-C65-0 | 65          | 349-50713                   |

Cable Assembly Instructions are available online at [www.amphenorlf.com](http://www.amphenorlf.com). Consult factory for available keying codes.



## Cable Connectors: GEN 2.0

### Straight Jacks (continued)



#### Single w/Clip Slot Provision

| Part Number     | Cable Group | Cable Assembly Instructions |
|-----------------|-------------|-----------------------------|
| 2FA1-NXSJ-C01-6 | 01          | 349-50713                   |
| 2FA1-NXSJ-C04-6 | 04          | 349-50713                   |
| 2FA1-NXSJ-C62-6 | 62          | 349-50713                   |
| 2FA1-NXSJ-C65-6 | 65          | 349-50713                   |



#### Dual

| Part Number     | Cable Group | Cable Assembly Instructions |
|-----------------|-------------|-----------------------------|
| 2FA2-NXSJ-C00-0 | 00          | 349-50713                   |
| 2FA2-NXSJ-C01-0 | 01          | 349-50713                   |
| 2FA2-NXSJ-C04-0 | 04          | 349-50713                   |



#### Dual – 8mm (High Density) w/Clip Slot Provision

| Part Number w/Contact | w/o Contact | Cable Group | Cable Assembly Instructions |
|-----------------------|-------------|-------------|-----------------------------|
| 2FAH-NXSJ-C00-6       | C00W6       | 00          | 349-50767                   |
| C01-6                 | C01W6       | 01          | 349-50767                   |
| C04-6                 | C04W6       | 04          | 349-50767                   |
| C62-6                 | C62W6       | 62          | 349-50767                   |
| C99-6                 | C99W6       | 99          | 349-50767                   |

### Right Angle Jacks



#### Right Angle

| Part Number     | Cable Group | Cable Assembly Instructions |
|-----------------|-------------|-----------------------------|
| 2FA1-NXRJ-C01-3 | 01          | 349-50785                   |
| 2FA1-NXRJ-C04-3 | 04          | 349-50785                   |
| 2FA1-NXRJ-C65-3 | 65          | 349-50785                   |

Cable Assembly Instructions are available online at [www.amphenorlf.com](http://www.amphenorlf.com).  
Consult factory for available keying codes.



3-Way Straight Plugs\*



**Straight 3-Way**

| Part Number  | Cable Group                       | Cable Assembly Instructions |
|--------------|-----------------------------------|-----------------------------|
| 2FA3-041P-I1 | cable options:<br>blank / 01 / 04 | 349-50727                   |
| 2FA3-055P-I1 | blank / 05 / 05                   | 349-50727                   |



**Straight 3-Way**

| Part Number  | Cable Group               | Cable Assembly Instructions |
|--------------|---------------------------|-----------------------------|
| 2FA3-141P-G1 | cable options:<br>01 / 04 | 349-50727                   |
| 2FA3-555P-G1 | 05 / 05 / 05              | 349-50727                   |

3-Way Straight Jacks\*



**Straight 3-Way**

| Part Number | Cable Group                       | Cable Assembly Instructions |
|-------------|-----------------------------------|-----------------------------|
| 2FA3D041J-I | cable options:<br>blank / 01 / 04 | 349-50705                   |



**Straight 3-Way**

| Part Number | Cable Group               | Cable Assembly Instructions |
|-------------|---------------------------|-----------------------------|
| 2FA3D141J-G | cable options:<br>01 / 04 | 349-50705                   |



**Straight 3-Way (w/insulated Ferrule)**

| Part Number  | Cable Group                       | Cable Assembly Instructions |
|--------------|-----------------------------------|-----------------------------|
| 2FA3D041J-IH | cable options:<br>blank / 01 / 04 | 349-50705                   |



**Straight 3-Way (w/insulated Ferrule)**

| Part Number  | Cable Group               | Cable Assembly Instructions |
|--------------|---------------------------|-----------------------------|
| 2FA3D141J-GH | cable options:<br>01 / 04 | 349-50705                   |

\*Amphenol RF 3-Way Jacks and Plugs Patent Pending  
Cable Assembly Instructions are available online at [www.amphenorlf.com](http://www.amphenorlf.com).  
Consult factory for available keying codes.



## Cable Connectors: GEN 2.5

| For Center Contacts | Diameter of reel             | Pitch between contacts | Packaging                                  |
|---------------------|------------------------------|------------------------|--|
| FKCP03301A          | 330 mm<br>(Hub size: 12.7mm) | 5 mm                   | Tape and reel packaging<br>(5000 contacts) |
| FKCP03401A          |                              |                        |  |

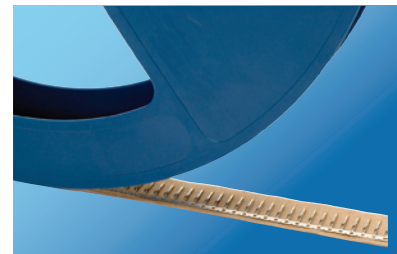
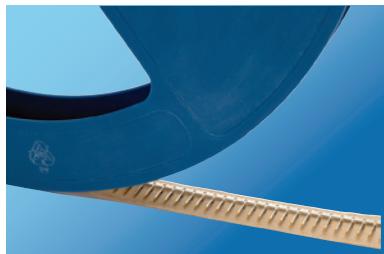
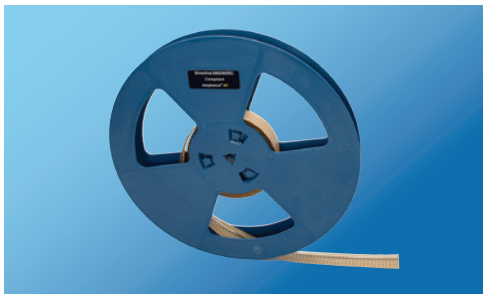

Generation 2.5 reels are available in both left and right orientations.

### Straight Plugs



#### Single

| Part Number w/Contact | w/o Contact | Cable Group | Cable Assembly Instructions |
|-----------------------|-------------|-------------|-----------------------------|
| 2FA1-NXSP-C01S1       | C01W1       | 01          | 349-50747                   |
| C04S1                 | C04W1       | 04          | 349-50747                   |
| C65S1                 | C65W1       | 65          | 349-50747                   |
| C71S1                 | C71W1       | 71          | 349-50747                   |

### Straight Jacks



#### Single

| Part Number w/Contact | w/o Contact | Cable Group | Cable Assembly Instructions |
|-----------------------|-------------|-------------|-----------------------------|
| 2FA1-NXSJ-C01S0       | C01W0       | 01          | 349-50747                   |
| C04S0                 | C04W0       | 04          | 349-50747                   |
| C65S0                 | C65W0       | 65          | 349-50747                   |
| C71S0                 | C71W0       | 71          | 349-50747                   |

### Single Jacks w/Clip Slot Provision



#### Single

| Part Number w/Contact | w/o Contact | Cable Group | Cable Assembly Instructions |
|-----------------------|-------------|-------------|-----------------------------|
| 2FA1-NXSJ-C01S6       | C01W6       | 01          | 349-50747                   |
| C04S6                 | C04W6       | 04          | 349-50747                   |
| C65S6                 | C65W6       | 65          | 349-50747                   |
| C71S6                 | C71W6       | 71          | 349-50747                   |

Cable Assembly Instructions are available online at [www.amphenolrf.com](http://www.amphenolrf.com). Consult factory for available keying codes.





**Straight Plugs**



**Vertical Mount PCB**

| Part Number    | Cable Group | Cable Assembly Instructions |
|----------------|-------------|-----------------------------|
| FA1-NXSP-PCB-2 | N/A         | N/A                         |

**Edgemount Plugs**



**Edgemount PCB w/lockpins**

| Part Number     | Cable Group | Cable Assembly Instructions |
|-----------------|-------------|-----------------------------|
| FC2-NCDSP-C00-0 | N/A         | N/A                         |



**Edgemount PCB**

| Part Number    | Cable Group | Cable Assembly Instructions |
|----------------|-------------|-----------------------------|
| FA1-NXSP-PCB-1 | N/A         | N/A                         |



**Edgemount SMT PCB**

| Part Number    | Cable Group | Cable Assembly Instructions |
|----------------|-------------|-----------------------------|
| FA1-NXSP-PCB-X | N/A         | N/A                         |

**Right Angle Plugs**



**Right Angle PCB Mount**

| Part Number    | Cable Group          | Cable Assembly Instructions |
|----------------|----------------------|-----------------------------|
| FA1-NXRP-PCB-X | N/A                  | N/A                         |
|                | 6 (Gold Plated Body) |                             |
|                | 8 (Tin Plated Body)  |                             |



**Right Angle SMT PCB Mount**

| Part Number     | Cable Group | Cable Assembly Instructions |
|-----------------|-------------|-----------------------------|
| FA1-NXRP-PCB-11 | N/A         | N/A                         |

Cable Assembly Instructions are available online at [www.amphenolrf.com](http://www.amphenolrf.com). Consult factory for available keying codes.



## PCB Connectors: GEN 2.0

### Edgemount Plugs



#### Edgemount PCB

| Part Number     | Cable Group | Cable Assembly Instructions |
|-----------------|-------------|-----------------------------|
| 2FA1-NXSP-PCB-P | N/A         | N/A                         |

### Right Angle Plugs



#### Right Angle PCB Mount

| Part Number     | Cable Group | Cable Assembly Instructions |
|-----------------|-------------|-----------------------------|
| 2FA1-NXRP-PCB-R | N/A         | N/A                         |



#### Right Angle PCB Mount

| Part Number     | Cable Group | Cable Assembly Instructions |
|-----------------|-------------|-----------------------------|
| 2FA1-SDRP-PCB-A | N/A         | N/A                         |
| 2FA1-SDRP-PCB-B | N/A         | N/A                         |
| 2FA1-SDRP-PCB-I | N/A         | N/A                         |

### Dual Jacks



#### Combo (2 singles) PCB Mount

| Part Number     | Cable Group | Cable Assembly Instructions |
|-----------------|-------------|-----------------------------|
| 2FA2-SDRP-PCBAB | N/A         | N/A                         |



#### Dual PCB Mount

| Part Number     | Cable Group | Cable Assembly Instructions |
|-----------------|-------------|-----------------------------|
| 2FA2-SDRP-PCB-E | N/A         | N/A                         |

Cable Assembly Instructions are available online at [www.amphenorlf.com](http://www.amphenorlf.com).  
Consult factory for available keying codes.



**8mm Plugs**



**Dual - 8mm (High Density) Right Angle**

| <u>Part Number</u> | <u>Cable Group</u> | <u>Cable Assembly Instructions</u> |
|--------------------|--------------------|------------------------------------|
| 2FAH-NXRP-PCB-1    | N/A                | N/A                                |



**Dual - 8mm (High Density) Vertical Mount**

| <u>Part Number</u> | <u>Cable Group</u> | <u>Cable Assembly Instructions</u> |
|--------------------|--------------------|------------------------------------|
| 2FAH-NXSP-PCB-1    | N/A                | N/A                                |

Cable Assembly Instructions are available online at [www.amphenorlf.com](http://www.amphenorlf.com). Consult factory for available keying codes.

# Termination Tooling

## Recommended Termination Tooling (Gen 1.0 and 2.0)

|     |                     |                  | Hand-Crimp Tool |          | Pneumatic Crimp Tool |          | Positioner (Center Pin) / Die Set (Ferrule) |             | Depth Setting * |
|-----|---------------------|------------------|-----------------|----------|----------------------|----------|---|-------------|-----------------|
|     |                     |                  | Daniels         | Amphenol | Daniels              | Amphenol | Daniels                                     | Amphenol    |                 |
| C01 | RG-174,<br>188, 316 | Center Pin       | AFM8            | 227-1454 | WA22                 | 227-WA22 | K727  | 227-K727    | 4               |
|     |                     | Ferrule (Single) | HX4             | 227-944  | HX23                 | 227-HX23 | Y119  | 227-1221-3  |                 |
|     |                     | Ferrule (Dual)   | HX4             | 227-944  | HX23                 | 227-HX23 | Y1831                                       | 227-Y1831   |                 |
| C04 | RG-58, 141          | Center Pin       | AFM8            | 227-1454 | WA22                 | 227-WA22 | K1470                                       | 227-K1470   | 6 / 7           |
|     |                     | Ferrule (Single) | HX4             | 227-944  | HX23                 | 227-HX23 | Y188  | 227-1221-11 |                 |
|     |                     | Ferrule (Dual)   | HX4             | 227-944  | HX23                 | 227-HX23 | Y1832                                       | 227-Y1832   |                 |
| C05 | 1.5DS-QEHV          | Center Pin       | AFM8            | 227-1454 | WA22                 | 227-WA22 | K727  | 227-K727    | 4               |
|     |                     | Ferrule (Single) | HX4             | 227-944  | HX23                 | 227-HX23 | Y119  | 227-1221-3  |                 |
|     |                     | Ferrule (Dual)   | HX4             | 227-944  | HX23                 | 227-HX23 | Y1831                                       | 227-Y1831   |                 |
| C07 | 1.5DS-GXC-SP        | Center Pin       | AFM8            | 227-1454 | WA22                 | 227-WA22 | K727  | 227-K727    | 4               |
|     |                     | Ferrule (Single) | HX4             | 227-944  | HX23                 | 227-HX23 | Y119  | 227-1221-3  |                 |
|     |                     | Ferrule (Dual)   | HX4             | 227-944  | HX23                 | 227-HX23 | Y1831                                       | 227-Y1831   |                 |
| C10 | RG-178,<br>196 TYPE | Center Pin       | AFM8            | 227-1454 | WA22                 | 227-WA22 | K727  | 227-K727    | 2 / 4           |
|     |                     | Ferrule (Single) | HX4             | 227-944  | HX23                 | 227-HX23 | Y119  | 227-1221-3  |                 |
|     |                     | Ferrule (Dual)   | HX4             | 227-944  | HX23                 | 227-HX23 | Y1831                                       | 227-Y1831   |                 |
| C62 | RG-62               | Center Pin       | AFM8            | 227-1454 | WA22                 | 227-WA22 | K727  | 227-K727    | 4 / 5           |
|     |                     | Ferrule (Single) | HX4             | 227-944  | HX23                 | 227-HX23 | Y188  | 227-1221-11 |                 |
|     |                     | Ferrule (Dual)   | HX4             | 227-944  | HX23                 | 227-HX23 | Y1832                                       | 227-Y1832   |                 |

Please note: The dual ferrule die sets can be used on the single ferrule designs.

\*Depth setting should be used at the minimum setting which will yield 5 lbs minimum pull-off force. Depth setting requirements depend upon several factors including cable manufacturer and grade.

FAKRA connectors for Cable Groups 65 and 71 are currently available on tape and reel for use with Generation 2.5. Please refer to specific Cable Assembly Instructions for tooling information.

Through our global engineering group and world-wide support, Amphenol RF is able to provide custom solutions for unique FAKRA challenges as well as other RF, coaxial products and cable assemblies.

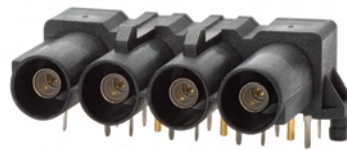

4-Way Plug

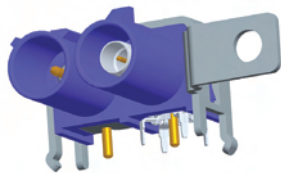

8mm Hybrid PCB Plug  
(1 RF Port, 1 DC Port)

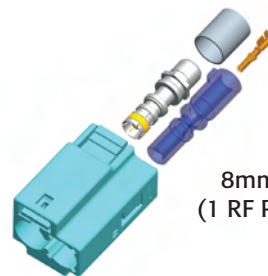

8mm Hybrid Jack  
(1 RF Port, 1 DC Port)

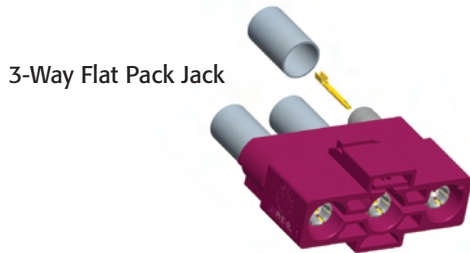

3-Way Flat Pack Jack

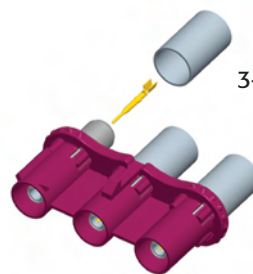

3-Way Flat Pack Plug

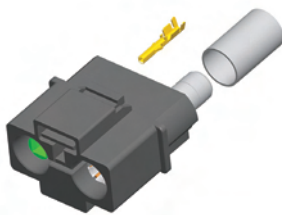

12.7mm Hybrid Jack  
(1 RF Port, 1 DC Port)



12.7mm Hybrid Plug  
(1 RF Port, 1 DC Port)

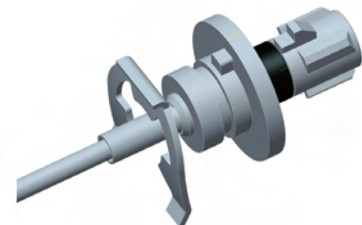

Panel-mount Plug





**Ordering Information**

To obtain information on price and delivery, please contact your nearest Amphenol Sales Office.

For the primary customer service line, please call 1-800-627-7100

**Specifications** in this catalog are subject to change without notice. While the information contained in this catalog has been carefully compiled to the best of our present knowledge, it is not intended as representation or warranty of any kind on our part regarding the suitability of the products concerned for any particular use or purpose. Please contact your Amphenol® RF sales representative for additional information regarding specifications.

Amphenol is a registered trademark of Amphenol Corporation.  
© 2007, Amphenol RF

rev. b

**Amphenol RF Part Numbering System**

| Single and Dual Products |   |   |              |              |                 |          |            |                          |   |                                      |         |                                      |         |   |
|--------------------------|---|---|--------------|--------------|-----------------|----------|------------|--------------------------|---|--------------------------------------|---------|--------------------------------------|---------|---|
| X                        | F | A | X            | -            | X               | X        | X          | X                        | - | X                                    | X       | X                                    | -       | # |
| Series                   |   |   | Tab Location | Keying Codes | Style           | Gender   | Attachment |                          |   | " - " (standard)<br>S (reel contact) | Special |                                      |         |   |
| Blank (Gen 1.0)          |   |   | N (North)    | see<br>chart | S (Straight)    | P (Plug) | C          | Cable Group<br>see chart |   |                                      |         | " - " (standard)<br>S (reel contact) | Special |   |
| 2 (Gen 2.0 & 2.5)        |   |   | S (South)    |              | R (Right Angle) | J (Jack) | P          | C                        | B |                                      |         |                                      |         |   |
|                          |   |   | E (East)     |              |                 |          |            |                          |   |                                      |         |                                      |         |   |
|                          |   |   | W (West)     |              |                 |          |            |                          |   |                                      |         |                                      |         |   |

| 3-Way Product |   |   |   |                      |  |                      |        |                     |                         |         |   |
|---------------|---|---|---|----------------------|--|----------------------|--------|---------------------|-------------------------|---------|---|
| 2             | F | A | 3 | X                    | X  | X                    | X      | X                   | -                       | X       | X |
| Series        |   |   |   | - (Plug)<br>D (Jack) | Cable type                               |                      | Gender | Factory<br>Assigned | Key Code<br>(see chart) | Special |   |
|               |   |   |   |                      | 1 (Cable Group 01)<br>4 (Cable Group 04) | P (Plug)<br>J (Jack) |        |                     |                         |         |   |

| Cable Assembly Codes |                                |                               |                           |                     |
|----------------------|--------------------------------|-------------------------------|---------------------------|---------------------|
| **                   | Cable Types                    | Center Contact<br>(mm/inches) | Dielectric<br>(mm/inches) | O.D.<br>(mm/inches) |
| 00                   | RG-58/RG-174 Combo Design      | Reference C01 and C04 (below) |                           |                     |
| 01                   | RG-174, 188, 316               | 0.536 / 0.0211                | 1.600 / 0.0630            | 3.200 / 0.1260      |
| 04                   | RG-58, 141                     | 1.020 / 0.0402                | 3.070 / 0.1209            | 5.054 / 0.1990      |
| 05                   | 1.5DS-QEHV                     | 0.540 / 0.0213                | 1.670 / 0.0660            | 3.500 / 0.1378      |
| 07                   | 1.5DS-GXC-SP                   | 0.630 / 0.0248                | 1.670 / 0.0660            | 3.200 / 0.126       |
| 10                   | RG-178, 196 Type               | 0.330 / 0.0130                | 0.941 / 0.0370            | 1.905 / 0.0750      |
| 62                   | 5P3-46B                        | 0.510 / 0.0201                | 3.200 / 0.1260            | 5.106 / 0.2010      |
| 65                   | RG-59, 62 Type                 | 0.570 / 0.0224                | 3.850 / 0.1516            | 6.350 / 0.2500      |
| 71                   | RG-71 / U M (Ford)             | 0.340 / 0.0134                | 3.840 / 0.1512            | 6.400 / 0.2520      |
| 99                   | RG-59 Type/RG-174 Combo Design | Reference C01 and C65 (above) |                           |                     |

| #   | Special Codes (Plug PCB)             |
|---|--------------------------------------|
| 0   | Edgemount                            |
| 1   | Edgemount w/Support Legs             |
| 2   | Vertical Mount                       |
| 6   | Right Angle (Gold)                   |
| 8   | Right Angle (Tin)                    |
| M   | Right Angle Die Cast (metal housing) |
| S   | Right Angle Stamped & Formed         |
| X   | Edgemount Pin & Paste                |
| Note: For the -6 & -8, add an "A" to the end for assembled part w/housing |                                      |

| # | Special Codes (Plug)               |
|---|------------------------------------|
| 0 | Standard Bracket (single and dual) |
| 1 | Single In-Line                     |
| 9 | Dual In-Line                       |
| X | Special Bracket                    |

| # | Special Codes (Jack)   |
|---|------------------------|
| 0 | Standard               |
| 3 | 360° Design (R/A only) |
| 6 | Clip provision at 180° |

# Amphenol<sup>®</sup> RF

RF Solutions for the Telematics Market

## **Amphenol<sup>®</sup> RF Danbury**

4 Old Newtown Road  
Danbury, CT 06810 USA  
Tel: (800) 627-7100  
Tel: (203) 743-9272  
Fax: (203) 796-2032

## **Amphenol<sup>®</sup> RF Shenzhen**

Block DM2, Tong Wei Industrial District  
Industry General Co.  
Gong Ming Town, Bao An District  
Shenzhen 518132, P.R. China  
Tel: 86-755-2717-7843  
Fax: 86-755-2717-7845

[www.amphenolrf.com](http://www.amphenolrf.com)





Компания «ЭлектроПласт» предлагает заключение долгосрочных отношений при поставках импортных электронных компонентов на взаимовыгодных условиях!

Наши преимущества:

- Оперативные поставки широкого спектра электронных компонентов отечественного и импортного производства напрямую от производителей и с крупнейших мировых складов;
- Поставка более 17-ти миллионов наименований электронных компонентов;
- Поставка сложных, дефицитных, либо снятых с производства позиций;
- Оперативные сроки поставки под заказ (от 5 рабочих дней);
- Экспресс доставка в любую точку России;
- Техническая поддержка проекта, помощь в подборе аналогов, поставка прототипов;
- Система менеджмента качества сертифицирована по Международному стандарту ISO 9001;
- Лицензия ФСБ на осуществление работ с использованием сведений, составляющих государственную тайну;
- Поставка специализированных компонентов (Xilinx, Altera, Analog Devices, Intersil, Interpoint, Microsemi, Aeroflex, Peregrine, Syfer, Eurofarad, Texas Instrument, Miteq, Cobham, E2V, MA-COM, Hittite, Mini-Circuits, General Dynamics и др.);

Помимо этого, одним из направлений компании «ЭлектроПласт» является направление «Источники питания». Мы предлагаем Вам помощь Конструкторского отдела:

- Подбор оптимального решения, техническое обоснование при выборе компонента;
- Подбор аналогов;
- Консультации по применению компонента;
- Поставка образцов и прототипов;
- Техническая поддержка проекта;
- Защита от снятия компонента с производства.



#### Как с нами связаться

**Телефон:** 8 (812) 309 58 32 (многоканальный)

**Факс:** 8 (812) 320-02-42

**Электронная почта:** [org@eplast1.ru](mailto:org@eplast1.ru)

**Адрес:** 198099, г. Санкт-Петербург, ул. Калинина, дом 2, корпус 4, литера А.