

Amphenol® RF

RF Solutions for the Telematics Market



FAKRA SMB Connectors

Version 3.0

Contents

Introduction to FAKRA	1
Product Overview	2
Specifications	
FAKRA/USCAR Product Specifications	3
Plug Keying Options	4
Jack Keying Options	4
Dual Housings	4
Part Numbering System	5
Mechanical and Color Coding	5
Cable Assembly Codes	6
Special Codes	6
FAKRA Plug Interface	7
FAKRA Jack Interface	8
<hr/>	
Cable Connectors GEN 1.0	
Straight Plugs	9
Straight Jacks	10
Right Angle Jacks	10
Cable Connectors: GEN 2.0	
Straight Plugs	11
Straight Jacks	11-12
Right Angle Jacks	12
3-Way Plugs	13
3-Way Jacks	13
Cable Connectors: GEN 2.5	
Straight Plugs	14
Straight Jacks	14
<hr/>	
PCB Connectors: GEN 1.0	
Straight Plugs	15
Edgemount Plugs	15
Right Angle Plugs	15
PCB Connectors: GEN 2.0	
Edgemount Plugs	16
Right Angle Plugs	16
Dual Jacks	16
8mm Plugs	17
<hr/>	
Termination Tooling	18
Concepts	19



Male = Plug
Female = Jack

Meets USCAR 2, 17 and 18

RF Solutions for the Automotive Market

Introduction

The automotive industry has been revolutionized with the increased adoption of telematics in vehicles including GPS, Cellular, Bluetooth and Satellite Radio. No longer are satellite navigation systems and sophisticated in-vehicle entertainment confined solely to the luxury end of the market.

As telematic advancements become more reliable, available and inexpensive, vehicles are transforming into an intelligent platform for enabling mobile life. With these recent advancements in communications technology and increased consumer demand for a diverse array of on-board telematics services, RF communications systems have become integral components of today's automobile, trucking, watercraft, motorcycle and off-road construction markets.

To keep RF interconnection costs low, and to ensure high levels of electrical and mechanical performance for telematics applications, such as Global Positioning Satellite, Satellite Radio, Vehicular Internet Access, Remote vehicle diagnostics and Bluetooth, the worldwide automotive industries have standardized a high-performing, cost-effective RF connector based on the FAKRA and USCAR standards.

Utilizing a modified metal SMB connector embedded within a plastic housing that can be designed with multiple color codes for easy identification, FAKRA connectors are designed to perform up to 6 GHz and meet the particular mechanical and environmental requirements of the automotive industry. Amphenol RF also offers a variety of connectors for board-to-board, PCB interfaces, and traditional antenna interfaces.

Technologies Supported

AM/FM Radio: Antenna technology that supports GPS and Satellite Radio is the same antenna that will support AM/FM radio. This combined antenna capability not only reduces the number of external antennas on the vehicles, but offers standardization among the interconnects.

Satellite Radio: Originating at a broadcast center, the broadcast signal is beamed from earth-station antennas to broadcast satellites. These satellites don't move and are positioned more than 22,000 miles above the earth in geo-stationary orbit. Their beams combine to span the entire contiguous U.S. while remaining stationary with respect to the land below.

GPS (Global Positioning System): A worldwide MEO satellite navigational system formed by 24 satellites orbiting the earth and their corresponding receivers on the earth. The GPS satellites continuously transmit digital radio signals that contain data on the satellites' location and the exact time to the earth-bound receivers.

Cellular/PCS (Personal Communications Service): the U.S. Federal Communications Commission (FCC) term used to describe a set of digital cellular technologies being deployed in the U.S. It is also referred to as digital cellular.

Bluetooth: A short-range radio technology aimed at simplifying communications among Internet devices, between devices and the Internet. It also aims to simplify data synchronization between Internet devices and other computers.

Wireless Remote: Remote starting, remote keyless entry and door/window controls are all supported by our FAKRA products.

Vehicle Controls: Adaptive Cruise Control, Collision Avoidance Systems and DSRC (Dedicated Short Range Communications) are all evolving technologies that utilize FAKRA.

WiFi: Many new automotive models are incorporating WiFi in to their Infotainment offerings. Our FAKRA connectors support this emerging technology.

FAKRA Generation 1.0, 2.0, and 2.5

Product Overview

GENERATION 1.0

FAKRA Generation 1.0 utilizes a modified metal SMB connector embedded within a plastic housing unit for ease of identification and assembly. These plastic housings are designed with visually and mechanically coded and keyed tooling to eliminate assembly errors. Our standard FAKRA connectors are designed to perform up to 6 GHz and meet the electrical, mechanical and environmental standards of the automotive industry. Generation 1.0 typically features five separate component parts.

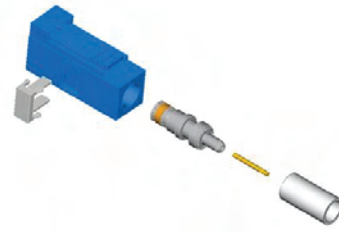

GENERATION 2.0

FAKRA Generation 2.0 offers reduced installation costs for our customers via a pre-assembled housing unit. This pre-assembled housing eliminates two loose components and their associated assembly and handling costs. Due to this component reduction, Generation 2.0 features three separate components to install versus Generation 1.0's five separate components.

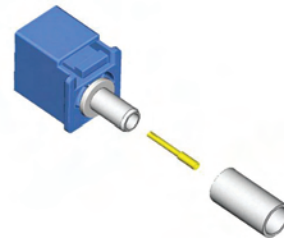

GENERATION 2.5

FAKRA Generation 2.5 offers the same pre-assembled housing units and design improvements as Generation 2.0, but center contacts are provided on a tape and reel for automated distribution and placement.

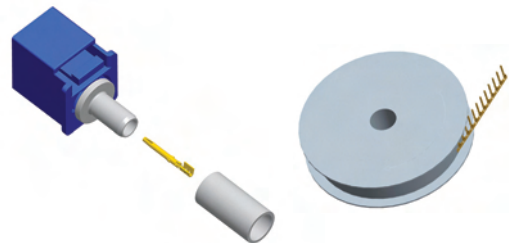

Cable Assembly Instructions

For your convenience and to insure that you have the latest information, cable assembly instructions are available online at www.amphenorlf.com. Simply type in the cable assembly instruction number given with each part number and you will be directed to the correct cable assembly instruction.

FAKRA / USCAR Product Specifications

ELECTRICAL

Impedance		50 Ω nominal
Frequency Range		DC - 6 GHz (optimized for DC - 4 GHz)
Performance Spec		
V.S.W.R		DC - 2 GHz 2 GHz - 4 GHz
	<i>spec requirement</i>	1.40 max 1.50 max
Insertion Loss	<i>spec requirement</i>	≤ 0.3 dB max from DC - 3 GHz
Insulation Resistance		1000 M Ω min
Contact Resistance	<i>center contact</i>	< 40 mΩ
	<i>outer contact</i>	< 40 mΩ
Dielectric Withstanding Voltage	<i>at sea level</i>	> 800 VRMS (Interface only; may be cable limited)

MECHANICAL

Durability (matings)		100 min
Plastic Housing - Engagement Force		≤ 40 N (Single FAKRA)
Plastic Housing - Disengagement Force		≥ 35 N (Single FAKRA)
Cable Retention Force		≥ 110 N
Coding		14 mechanical and colored codings
Interface		USCAR-18, DIN

ENVIRONMENTAL

Temperature Range	<i>operating</i>	-40 / +100° C
Thermal Shock		MIL-STD-202, Method 107, Cond B (-55 / +125° C) or USCAR-2, para 5.6.1
Vibration		MIL-STD-202, Method 204, Cond B; (15g) or USCAR-2, para 5.4.6
Shock		MIL-STD-202, Method 213, Cond B (75g, 6 ms, 1/2 sine) or USCAR-2, para 5.4.6

MATERIALS

Plastic Housing	<i>jacks</i>	Nylon, PBT or PPE
	<i>in-line plugs</i>	Nylon or PBT
	<i>PCB plugs</i>	Nylon
Secondary Locking Clip (if applicable)		PBT
Center Contact	<i>jack</i>	Beryllium Copper or Phosphor Bronze
	<i>plug</i>	Brass or Phosphor Bronze
Body		Brass, Zinc Alloy
Retainer Ring (if applicable)		Beryllium Copper
Ferrule		Copper Alloy
Insulator		TFE or TPX

PLATING

Center Contact		Gold
Body	<i>cable types</i>	Nickel
	<i>solder types</i>	Nickel, Gold, Tin
Ferrule		Nickel

Specifications

Plug Keying Options

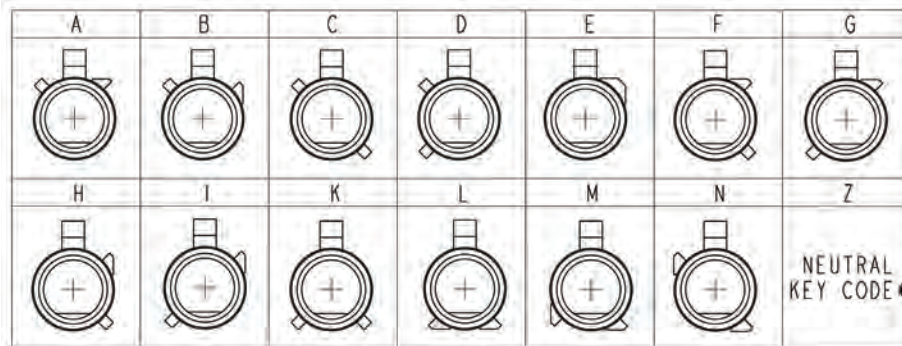

* "Z" or neutral key code is available that mates with the majority of FAKRA connections. Consult factory for intermateability options.

Jack Keying Options

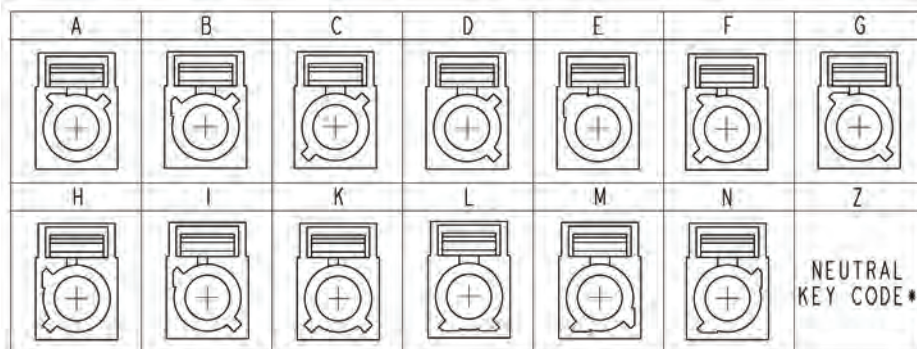

* "Z" or neutral key code is available that mates with the majority of FAKRA connections. Consult factory for intermateability options.

Dual Housings

Dual Housing
(Refer to Plug/Jack Keying for key options)

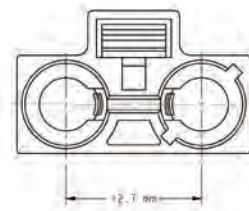
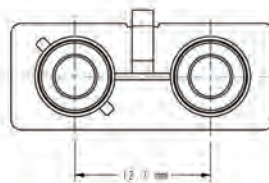

Dual - 8mm (High-Density) Housing
(Refer to Plug/Jack Keying for key options)

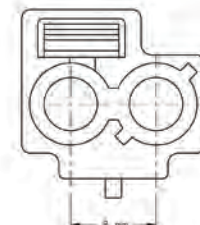
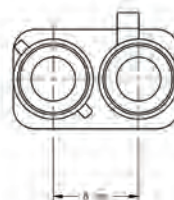

Amphenol RF Part Numbering System

Single and Dual Products														
X	F	A	X	-	X	X	X	X	-	X	X	X	-	#
Series			Tab Location	Keying Codes	Style	Gender	Attachment			" - " (standard) S (reel contact)	Special			
Blank (Gen 1.0)	1 (Single)		N (North)	see chart	S (Straight)	P (Plug)	C	Cable Group see chart						
2 (Gen 2.0 & 2.5)	2 (Dual)		S (South)		R (Right Angle)	J (Jack)	P	C	B					
			E (East)											
			W (West)											

3-Way Product											
2	F	A	3	X	X	X	X	X	-	X	X
Series				- (Plug) D (Jack)	Cable type			Gender	Factory Assigned	Key Code (see chart)	Special
				1 (Cable Group 01) 4 (Cable Group 04)			P (Plug) J (Jack)				

Mechanical and Color Coding

Coding	Rib Combination	Color	RAL no.
A	A - B1	Jet Black	9005
B	A - B2	Cream	9001
C	A - C	Signal Blue	5005
D	A - D	Claret Violet	4004
E	B1 - B2	Leaf Green	6002
F	B1 - C	Nut Brown	8011
G	B1 - D	Blue Grey	7031
H	B2 - C	Heather Violet	4003
I	B2 - D	Beige	1001
K	C - D	Curry	1027
L	H - J1	Carmine Red	3002
M	H - J2	Pastel Orange	3003
N	H - G1	Pastel Green	6019
Z	Neutral Coding	Water Blue	5021

Specifications

Cable Assembly Codes				
**	Cable Types	Center Contact (mm/inches)	Dielectric (mm/inches)	O.D. (mm/inches)
00	RG-58/RG-174 Combo Design	Reference C01 and C04 (below)		
01	RG-174, 188, 316	0.536 / 0.0211	1.600 / 0.0630	3.200 / 0.1260
04	RG-58, 141	1.020 / 0.0402	3.070 / 0.1209	5.054 / 0.1990
05	1.5DS-QEHV	0.540 / 0.0213	1.670 / 0.0660	3.500 / 0.1378
07	1.5DS-GXC-SP	0.630 / 0.0248	1.670 / 0.0660	3.200 / 0.126
10	RG-178, 196 Type	0.330 / 0.0130	0.941 / 0.0370	1.905 / 0.0750
62	5P3-46B	0.510 / 0.0201	3.200 / 0.1260	5.106 / 0.2010
65	RG-59, 62 Type	0.570 / 0.0224	3.850 / 0.1516	6.350 / 0.2500
71	RG-71 / U M (Ford)	0.340 / 0.0134	3.840 / 0.1512	6.400 / 0.2520
99	RG-59 Type / RG-174 Combo Design	Reference C01 and C65 (above)		

#	Special Codes (Plug)
0	Standard Bracket (single and dual)
1	Single In-Line
9	Dual In-Line
X	Special Bracket

#	Special Codes (Jack)
0	Standard
3	360° Design (R/A only)
6	Clip provision at 180°

#	Special Codes (Plug PCB)
0	Edgemount
1	Edgemount w/Support Legs
2	Vertical Mount
6	Right Angle (Gold)
8	Right Angle (Tin)
M	Right Angle Die Cast (metal housing)
S	Right Angle Stamped & Formed
X	Edgemount Pin & Paste
Note: For the -6 & -8, add an "A" to the end for assembled part w/housing	

Cable Assembly Instructions are available online at www.amphenolrf.com. Consult factory for available keying codes.

FAKRA Plug Interface

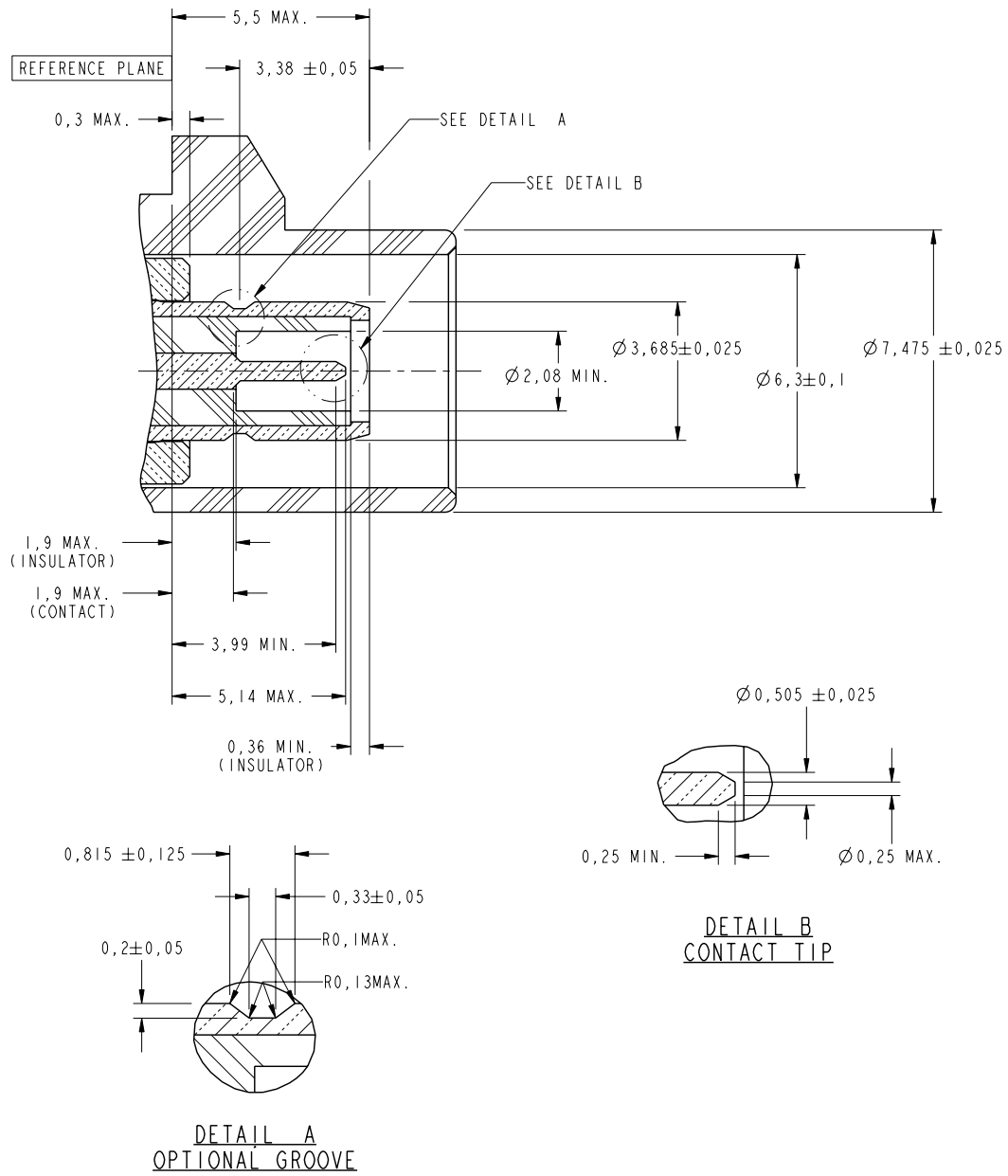

FAKRA Jack Interface

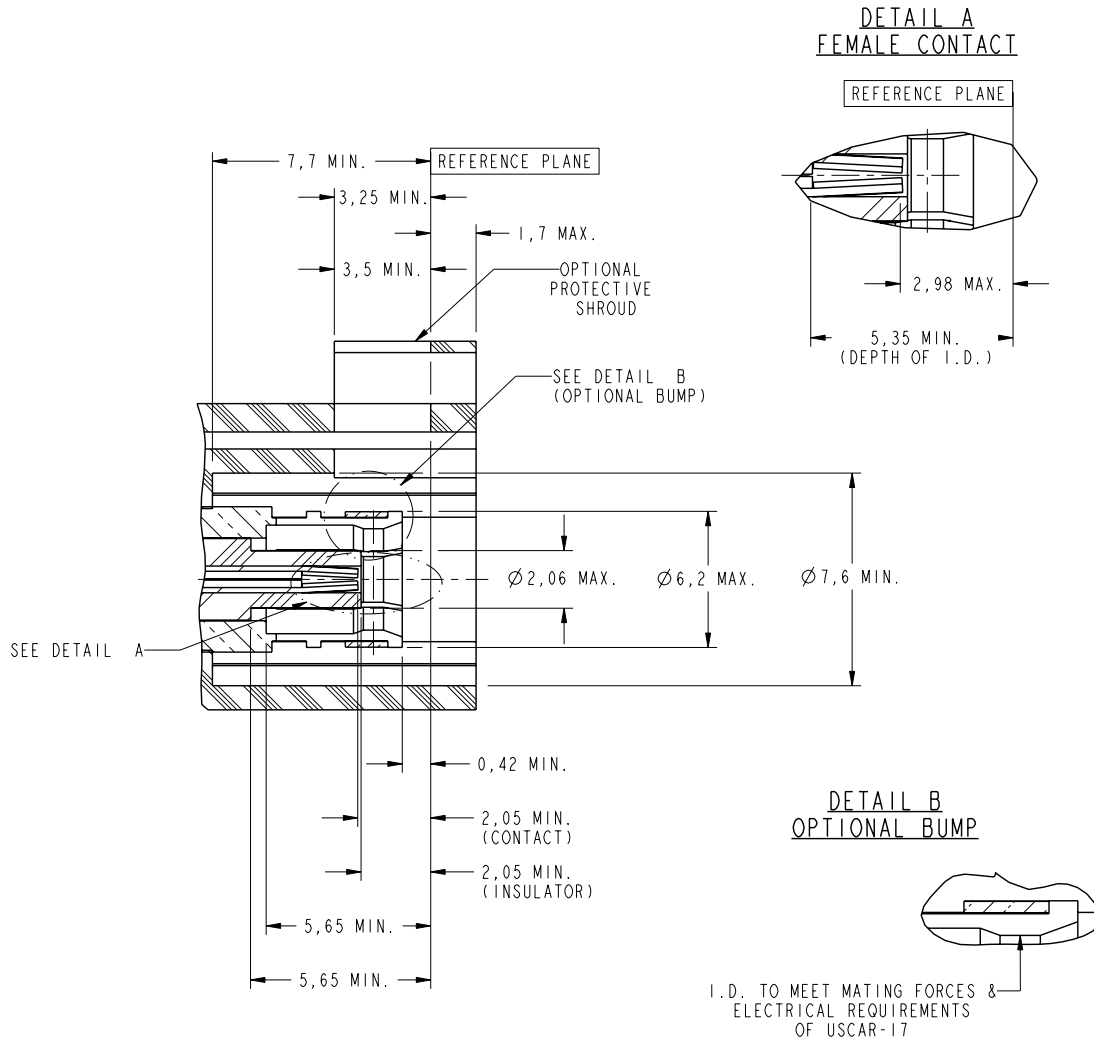



Straight Plugs



Single - Panel Mount

Part Number	Cable Group	Cable Assembly Instructions
FA1-NXSP-C01-5	01	349-50784



Single

Part Number	Cable Group	Cable Assembly Instructions
FA1-NXSP-C01-1	01	349-50781
FA1-NXSP-C04-1	04	349-50781
FA1-NXSP-C62-1	62	349-50781



Single w/Bracket

Part Number	Cable Group	Cable Assembly Instructions
FA1-NXSP-C01-0	01	349-50781
FA1-NXSP-C04-0	04	349-50781



Dual

Part Number	Cable Group	Cable Assembly Instructions
FA2-NXSP-C00-9	00	349-50781
FA2-NXSP-C01-9	01	349-50781
FA2-NXSP-C04-9	04	349-50781



Dual w/Bracket

Part Number	Cable Group	Cable Assembly Instructions
FA2-NXSP-C00-0	00	349-50781
FA2-NXSP-C04-0	04	349-50781
FA2-NXSP-C10-0	10	349-50781



Combo (2 singles) w/Bracket

Part Number	Cable Group	Cable Assembly Instructions
FC2-NCDSP-C00-0	00	349-50781



Combo (2 singles)

Part Number	Cable Group	Cable Assembly Instructions
FC2-NEKSP-C01-X	01	349-50781

Cable Assembly Instructions are available online at www.amphenorlf.com. Consult factory for available keying codes.



Cable Connectors: GEN 1.0

Straight Jacks



Single

Part Number	Cable Group	Cable Assembly Instructions
FA1-NXSJ-C01-0	01	349-50782
FA1-NXSJ-C04-0	04	349-50782
FA1-NXSJ-C07-0	07	349-50782
FA1-NXSJ-C10-0	10	349-50782
FA1-NXSJ-C62-0	62	349-50782



Single w/Clip Slot Provision

Part Number	Cable Group	Cable Assembly Instructions
FA1-NXSJ-C01-6	01	349-50782
FA1-NXSJ-C04-6	04	349-50782



Dual

Part Number	Cable Group	Cable Assembly Instructions
FA2-NXSJ-C00-0	00	349-50782
FA2-NXSJ-C01-0	01	349-50782
FA2-NXSJ-C04-0	04	349-50782



Dual w/Clip Slot Provision

Part Number	Cable Group	Cable Assembly Instructions
FA2-NXSJ-C00-6	00	349-50782
FA2-NXSJ-C01-6	01	349-50782
FA2-NXSJ-C04-6	04	349-50782

Right Angle Jacks



Single R/A

Part Number	Cable Group	Cable Assembly Instructions
FA1-NXRJ-C01-0	01	349-50783
FA1-NXRJ-C04-0	04	349-50783

Cable Assembly Instructions are available online at www.amphenorlf.com. Consult factory for available keying codes.



Straight Plugs



Single

Part Number	Cable Group	Cable Assembly Instructions
2FA1-NXSP-C01-1	01	349-50695
2FA1-NXSP-C04-1	04	349-50695
2FA1-NXSP-C65-1	65	349-50695
2FA1-NXSP-C71-1	71	349-50695



Dual - 8mm (High Density)

Part Number w/Contact	w/o Contact	Cable Group	Cable Assembly Instructions
2FAH-NXSP-C00-9	C00W9	00	349-50767
C01-9	C01W9	01	349-50767
C04-9	C04W9	04	349-50767
C62-9	C62W9	62	349-50767
C99-9	C99W9	99	349-50767



Dual

Part Number	Cable Group	Cable Assembly Instructions
2FA2-NXSP-C00-9	00	349-50695
2FA2-NXSP-C01-9	01	349-50695
2FA2-NXSP-C04-9	04	349-50695

Straight Jacks



Single

Part Number	Cable Group	Cable Assembly Instructions
2FA1-NXSJ-C01-0	01	349-50713
2FA1-NXSJ-C04-0	04	349-50713
2FA1-NXSJ-C62-0	62	349-50713
2FA1-NXSJ-C65-0	65	349-50713

Cable Assembly Instructions are available online at www.amphenorlf.com. Consult factory for available keying codes.



Cable Connectors: GEN 2.0

Straight Jacks (continued)



Single w/Clip Slot Provision

Part Number	Cable Group	Cable Assembly Instructions
2FA1-NXSJ-C01-6	01	349-50713
2FA1-NXSJ-C04-6	04	349-50713
2FA1-NXSJ-C62-6	62	349-50713
2FA1-NXSJ-C65-6	65	349-50713



Dual

Part Number	Cable Group	Cable Assembly Instructions
2FA2-NXSJ-C00-0	00	349-50713
2FA2-NXSJ-C01-0	01	349-50713
2FA2-NXSJ-C04-0	04	349-50713



Dual – 8mm (High Density) w/Clip Slot Provision

Part Number w/Contact	w/o Contact	Cable Group	Cable Assembly Instructions
2FAH-NXSJ-C00-6	C00W6	00	349-50767
C01-6	C01W6	01	349-50767
C04-6	C04W6	04	349-50767
C62-6	C62W6	62	349-50767
C99-6	C99W6	99	349-50767

Right Angle Jacks



Right Angle

Part Number	Cable Group	Cable Assembly Instructions
2FA1-NXRJ-C01-3	01	349-50785
2FA1-NXRJ-C04-3	04	349-50785
2FA1-NXRJ-C65-3	65	349-50785

Cable Assembly Instructions are available online at www.amphenorlf.com. Consult factory for available keying codes.



3-Way Straight Plugs*



Straight 3-Way

Part Number	Cable Group	Cable Assembly Instructions
2FA3-041P-I1	cable options: blank / 01 / 04	349-50727
2FA3-055P-I1	blank / 05 / 05	349-50727



Straight 3-Way

Part Number	Cable Group	Cable Assembly Instructions
2FA3-141P-G1	cable options: 01 / 04	349-50727
2FA3-555P-G1	05 / 05 / 05	349-50727

3-Way Straight Jacks*



Straight 3-Way

Part Number	Cable Group	Cable Assembly Instructions
2FA3D041J-I	cable options: blank / 01 / 04	349-50705



Straight 3-Way

Part Number	Cable Group	Cable Assembly Instructions
2FA3D141J-G	cable options: 01 / 04	349-50705



Straight 3-Way (w/insulated Ferrule)

Part Number	Cable Group	Cable Assembly Instructions
2FA3D041J-IH	cable options: blank / 01 / 04	349-50705



Straight 3-Way (w/insulated Ferrule)

Part Number	Cable Group	Cable Assembly Instructions
2FA3D141J-GH	cable options: 01 / 04	349-50705

*Amphenol RF 3-Way Jacks and Plugs Patent Pending
Cable Assembly Instructions are available online at www.amphenorlf.com.
Consult factory for available keying codes.



Cable Connectors: GEN 2.5

For Center Contacts	Diameter of reel	Pitch between contacts	Packaging
FKCP03301A	330 mm (Hub size: 12.7mm)	5 mm	Tape and reel packaging (5000 contacts)
FKCP03401A			

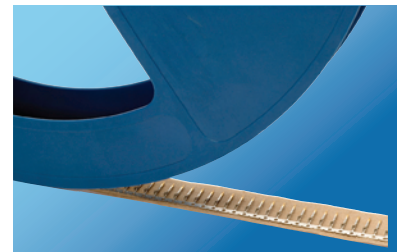
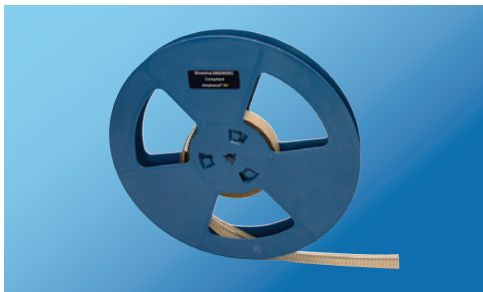

Generation 2.5 reels are available in both left and right orientations.

Straight Plugs



Single

Part Number w/Contact	w/o Contact	Cable Group	Cable Assembly Instructions
2FA1-NXSP-C01S1	C01W1	01	349-50747
C04S1	C04W1	04	349-50747
C65S1	C65W1	65	349-50747
C71S1	C71W1	71	349-50747

Straight Jacks



Single

Part Number w/Contact	w/o Contact	Cable Group	Cable Assembly Instructions
2FA1-NXSJ-C01S0	C01W0	01	349-50747
C04S0	C04W0	04	349-50747
C65S0	C65W0	65	349-50747
C71S0	C71W0	71	349-50747

Single Jacks w/Clip Slot Provision



Single

Part Number w/Contact	w/o Contact	Cable Group	Cable Assembly Instructions
2FA1-NXSJ-C01S6	C01W6	01	349-50747
C04S6	C04W6	04	349-50747
C65S6	C65W6	65	349-50747
C71S6	C71W6	71	349-50747

Cable Assembly Instructions are available online at www.amphenolrf.com. Consult factory for available keying codes.



Straight Plugs



Vertical Mount PCB

Part Number	Cable Group	Cable Assembly Instructions
FA1-NXSP-PCB-2	N/A	N/A

Edgemount Plugs



Edgemount PCB w/lockpins

Part Number	Cable Group	Cable Assembly Instructions
FC2-NCDSP-C00-0	N/A	N/A



Edgemount PCB

Part Number	Cable Group	Cable Assembly Instructions
FA1-NXSP-PCB-1	N/A	N/A



Edgemount SMT PCB

Part Number	Cable Group	Cable Assembly Instructions
FA1-NXSP-PCB-X	N/A	N/A

Right Angle Plugs



Right Angle PCB Mount

Part Number	Cable Group	Cable Assembly Instructions
FA1-NXRP-PCB-X	N/A	N/A
	6 (Gold Plated Body)	
	8 (Tin Plated Body)	



Right Angle SMT PCB Mount

Part Number	Cable Group	Cable Assembly Instructions
FA1-NXRP-PCB-11	N/A	N/A

Cable Assembly Instructions are available online at www.amphenolrf.com. Consult factory for available keying codes.



PCB Connectors: GEN 2.0

Edgemount Plugs



Edgemount PCB

Part Number	Cable Group	Cable Assembly Instructions
2FA1-NXSP-PCB-P	N/A	N/A

Right Angle Plugs



Right Angle PCB Mount

Part Number	Cable Group	Cable Assembly Instructions
2FA1-NXRP-PCB-R	N/A	N/A



Right Angle PCB Mount

Part Number	Cable Group	Cable Assembly Instructions
2FA1-SDRP-PCB-A	N/A	N/A
2FA1-SDRP-PCB-B	N/A	N/A
2FA1-SDRP-PCB-I	N/A	N/A

Dual Jacks



Combo (2 singles) PCB Mount

Part Number	Cable Group	Cable Assembly Instructions
2FA2-SDRP-PCBAB	N/A	N/A



Dual PCB Mount

Part Number	Cable Group	Cable Assembly Instructions
2FA2-SDRP-PCB-E	N/A	N/A

Cable Assembly Instructions are available online at www.amphenorlf.com.
Consult factory for available keying codes.



8mm Plugs



Dual - 8mm (High Density) Right Angle

Part Number	Cable Group	Cable Assembly Instructions
2FAH-NXRP-PCB-1	N/A	N/A



Dual - 8mm (High Density) Vertical Mount

Part Number	Cable Group	Cable Assembly Instructions
2FAH-NXSP-PCB-1	N/A	N/A

Cable Assembly Instructions are available online at www.amphenorlf.com. Consult factory for available keying codes.

Termination Tooling

Recommended Termination Tooling (Gen 1.0 and 2.0)

			Hand-Crimp Tool		Pneumatic Crimp Tool		Positioner (Center Pin) / Die Set (Ferrule)		Depth Setting *
			Daniels	Amphenol	Daniels	Amphenol	Daniels	Amphenol	
C01	RG-174, 188, 316	Center Pin	AFM8	227-1454	WA22	227-WA22	K727	227-K727	4
		Ferrule (Single)	HX4	227-944	HX23	227-HX23	Y119	227-1221-3	
		Ferrule (Dual)	HX4	227-944	HX23	227-HX23	Y1831	227-Y1831	
C04	RG-58, 141	Center Pin	AFM8	227-1454	WA22	227-WA22	K1470	227-K1470	6 / 7
		Ferrule (Single)	HX4	227-944	HX23	227-HX23	Y188	227-1221-11	
		Ferrule (Dual)	HX4	227-944	HX23	227-HX23	Y1832	227-Y1832	
C05	1.5DS-QEHV	Center Pin	AFM8	227-1454	WA22	227-WA22	K727	227-K727	4
		Ferrule (Single)	HX4	227-944	HX23	227-HX23	Y119	227-1221-3	
		Ferrule (Dual)	HX4	227-944	HX23	227-HX23	Y1831	227-Y1831	
C07	1.5DS-GXC-SP	Center Pin	AFM8	227-1454	WA22	227-WA22	K727	227-K727	4
		Ferrule (Single)	HX4	227-944	HX23	227-HX23	Y119	227-1221-3	
		Ferrule (Dual)	HX4	227-944	HX23	227-HX23	Y1831	227-Y1831	
C10	RG-178, 196 TYPE	Center Pin	AFM8	227-1454	WA22	227-WA22	K727	227-K727	2 / 4
		Ferrule (Single)	HX4	227-944	HX23	227-HX23	Y119	227-1221-3	
		Ferrule (Dual)	HX4	227-944	HX23	227-HX23	Y1831	227-Y1831	
C62	RG-62	Center Pin	AFM8	227-1454	WA22	227-WA22	K727	227-K727	4 / 5
		Ferrule (Single)	HX4	227-944	HX23	227-HX23	Y188	227-1221-11	
		Ferrule (Dual)	HX4	227-944	HX23	227-HX23	Y1832	227-Y1832	

Please note: The dual ferrule die sets can be used on the single ferrule designs.

*Depth setting should be used at the minimum setting which will yield 5 lbs minimum pull-off force. Depth setting requirements depend upon several factors including cable manufacturer and grade.

FAKRA connectors for Cable Groups 65 and 71 are currently available on tape and reel for use with Generation 2.5. Please refer to specific Cable Assembly Instructions for tooling information.

Through our global engineering group and world-wide support, Amphenol RF is able to provide custom solutions for unique FAKRA challenges as well as other RF, coaxial products and cable assemblies.

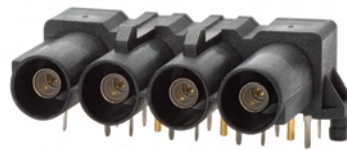

4-Way Plug

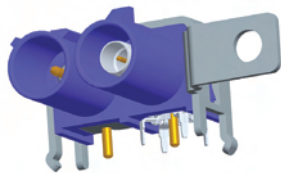

8mm Hybrid PCB Plug
(1 RF Port, 1 DC Port)

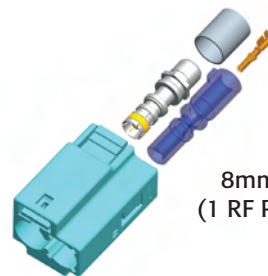

8mm Hybrid Jack
(1 RF Port, 1 DC Port)

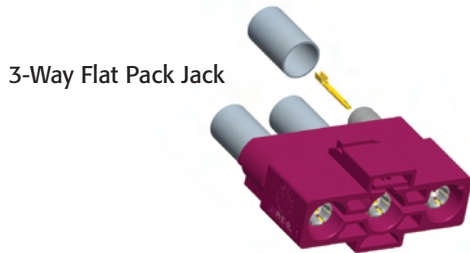

3-Way Flat Pack Jack

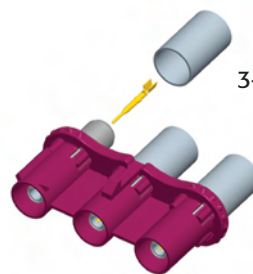

3-Way Flat Pack Plug

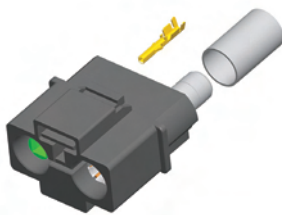

12.7mm Hybrid Jack
(1 RF Port, 1 DC Port)



12.7mm Hybrid Plug
(1 RF Port, 1 DC Port)

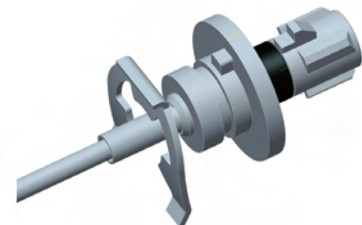

Panel-mount Plug





Ordering Information

To obtain information on price and delivery, please contact your nearest Amphenol Sales Office.

For the primary customer service line, please call 1-800-627-7100

Specifications in this catalog are subject to change without notice. While the information contained in this catalog has been carefully compiled to the best of our present knowledge, it is not intended as representation or warranty of any kind on our part regarding the suitability of the products concerned for any particular use or purpose. Please contact your Amphenol® RF sales representative for additional information regarding specifications.

Amphenol is a registered trademark of Amphenol Corporation.
© 2007, Amphenol RF

rev. b

Amphenol RF Part Numbering System

Single and Dual Products														
X	F	A	X	-	X	X	X	X	-	X	X	X	-	#
Series			Tab Location	Keying Codes	Style	Gender	Attachment			" - " (standard) S (reel contact)	Special			
Blank (Gen 1.0)			1 (Single)	N (North)	S (Straight)	P (Plug)	C	Cable Group see chart				" - " (standard) S (reel contact)	Special	
2 (Gen 2.0 & 2.5)			2 (Dual)	S (South) E (East) W (West)	R (Right Angle)	J (Jack)	P	C	B					

3-Way Product											
2	F	A	3	X	X	X	X	X	-	X	X
Series				- (Plug) D (Jack)	Cable type		Gender	Factory Assigned	Key Code (see chart)	Special	
					1 (Cable Group 01) 4 (Cable Group 04)	P (Plug) J (Jack)					

Cable Assembly Codes				
**	Cable Types	Center Contact (mm/inches)	Dielectric (mm/inches)	O.D. (mm/inches)
00	RG-58/RG-174 Combo Design	Reference C01 and C04 (below)		
01	RG-174, 188, 316	0.536 / 0.0211	1.600 / 0.0630	3.200 / 0.1260
04	RG-58, 141	1.020 / 0.0402	3.070 / 0.1209	5.054 / 0.1990
05	1.5DS-QEHV	0.540 / 0.0213	1.670 / 0.0660	3.500 / 0.1378
07	1.5DS-GXC-SP	0.630 / 0.0248	1.670 / 0.0660	3.200 / 0.126
10	RG-178, 196 Type	0.330 / 0.0130	0.941 / 0.0370	1.905 / 0.0750
62	5P3-46B	0.510 / 0.0201	3.200 / 0.1260	5.106 / 0.2010
65	RG-59, 62 Type	0.570 / 0.0224	3.850 / 0.1516	6.350 / 0.2500
71	RG-71 / U M (Ford)	0.340 / 0.0134	3.840 / 0.1512	6.400 / 0.2520
99	RG-59 Type/RG-174 Combo Design	Reference C01 and C65 (above)		

#	Special Codes (Plug PCB)
0	Edgemount
1	Edgemount w/Support Legs
2	Vertical Mount
6	Right Angle (Gold)
8	Right Angle (Tin)
M	Right Angle Die Cast (metal housing)
S	Right Angle Stamped & Formed
X	Edgemount Pin & Paste

Note: For the -6 & -8, add an "A" to the end for assembled part w/housing

#	Special Codes (Plug)
0	Standard Bracket (single and dual)
1	Single In-Line
9	Dual In-Line
X	Special Bracket

#	Special Codes (Jack)
0	Standard
3	360° Design (R/A only)
6	Clip provision at 180°

Amphenol[®] RF

RF Solutions for the Telematics Market

Amphenol[®] RF Danbury

4 Old Newtown Road
Danbury, CT 06810 USA
Tel: (800) 627-7100
Tel: (203) 743-9272
Fax: (203) 796-2032

Amphenol[®] RF Shenzhen

Block DM2, Tong Wei Industrial District
Industry General Co.
Gong Ming Town, Bao An District
Shenzhen 518132, P.R. China
Tel: 86-755-2717-7843
Fax: 86-755-2717-7845

www.amphenolrf.com



Компания «ЭлектроПласт» предлагает заключение долгосрочных отношений при поставках импортных электронных компонентов на взаимовыгодных условиях!

Наши преимущества:

- Оперативные поставки широкого спектра электронных компонентов отечественного и импортного производства напрямую от производителей и с крупнейших мировых складов;
- Поставка более 17-ти миллионов наименований электронных компонентов;
- Поставка сложных, дефицитных, либо снятых с производства позиций;
- Оперативные сроки поставки под заказ (от 5 рабочих дней);
- Экспресс доставка в любую точку России;
- Техническая поддержка проекта, помощь в подборе аналогов, поставка прототипов;
- Система менеджмента качества сертифицирована по Международному стандарту ISO 9001;
- Лицензия ФСБ на осуществление работ с использованием сведений, составляющих государственную тайну;
- Поставка специализированных компонентов (Xilinx, Altera, Analog Devices, Intersil, Interpoint, Microsemi, Aeroflex, Peregrine, Syfer, Eurofarad, Texas Instrument, Miteq, Cobham, E2V, MA-COM, Hittite, Mini-Circuits, General Dynamics и др.);

Помимо этого, одним из направлений компании «ЭлектроПласт» является направление «Источники питания». Мы предлагаем Вам помощь Конструкторского отдела:

- Подбор оптимального решения, техническое обоснование при выборе компонента;
- Подбор аналогов;
- Консультации по применению компонента;
- Поставка образцов и прототипов;
- Техническая поддержка проекта;
- Защита от снятия компонента с производства.



Как с нами связаться

Телефон: 8 (812) 309 58 32 (многоканальный)

Факс: 8 (812) 320-02-42

Электронная почта: org@eplast1.ru

Адрес: 198099, г. Санкт-Петербург, ул. Калинина, дом 2, корпус 4, литера А.