

The MPC941 is a 1:27 low voltage clock distribution chip. The device features the capability to select either a differential LVPECL or an LVCMOS compatible input. The 27 outputs are LVCMOS compatible and feature the drive strength to drive 50 Ω series or parallel terminated transmission lines. With output-to-output skews of 250 ps, the MPC941 is ideal as a clock distribution chip for the most demanding of synchronous systems. For a similar product with a smaller number of outputs, please consult the MPC940 data sheet.

- LVPECL or LVCMOS Clock Input
- 250 ps Maximum Output-to-Output Skew
- Drives Up to 54 Independent Clock Lines
- Maximum Output Frequency of 250 MHz
- High Impedance Output Enable
- Extended Temperature Range: -40°C to $+85^{\circ}\text{C}$
- 48-Lead LQFP Packaging, Pb-free
- 3.3 V or 2.5 V V_{CC} Supply Voltage

With a low output impedance, in both the HIGH and LOW logic states, the output buffers of the MPC941 are ideal for driving series terminated transmission lines. More specifically, each of the 27 MPC941 outputs can drive two series terminated 50 Ω transmission lines. With this capability, the MPC941 has an effective fanout of 1:54. With this level of fanout, the MPC941 provides enough copies of low skew clocks for most high performance synchronous systems.

The differential LVPECL inputs of the MPC941 allow the device to interface directly with an LVPECL fanout buffer like the MC100EP111 to build very wide clock fanout trees or to couple to a high frequency clock source. The LVCMOS input provides a more standard interface for applications requiring only a single clock distribution chip at relatively low frequencies. In addition, the two clock sources can be used as a test clock interface as well as the primary system clock. A logic HIGH on the LVCMOS_CLK_Sel pin will select the LVCMOS level clock input.

The MPC941 is fully 3.3 V and 2.5 V compatible. The 48-lead LQFP package was chosen to optimize performance, board space and cost of the device. The 48-lead LQFP has a 7x7 mm body size.

**LOW VOLTAGE 3.3 V/2.5 V
1:27 CLOCK
DISTRIBUTION CHIP**

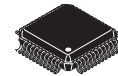

**AE SUFFIX
48-LEAD LQFP PACKAGE
Pb-FREE PACKAGE
CASE 932-03**

LOGIC DIAGRAM

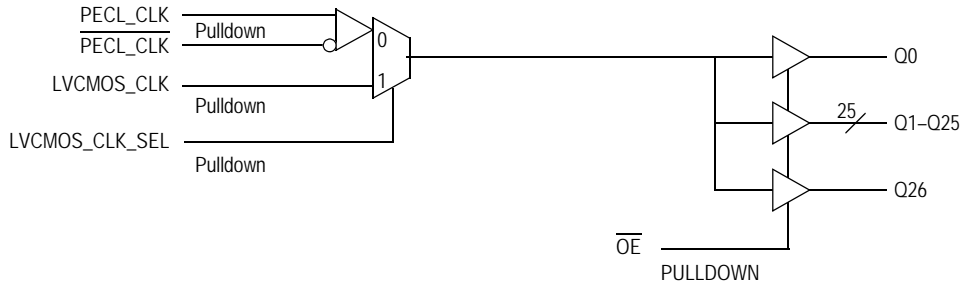

Pinout: 48-Lead TQFP (Top View)

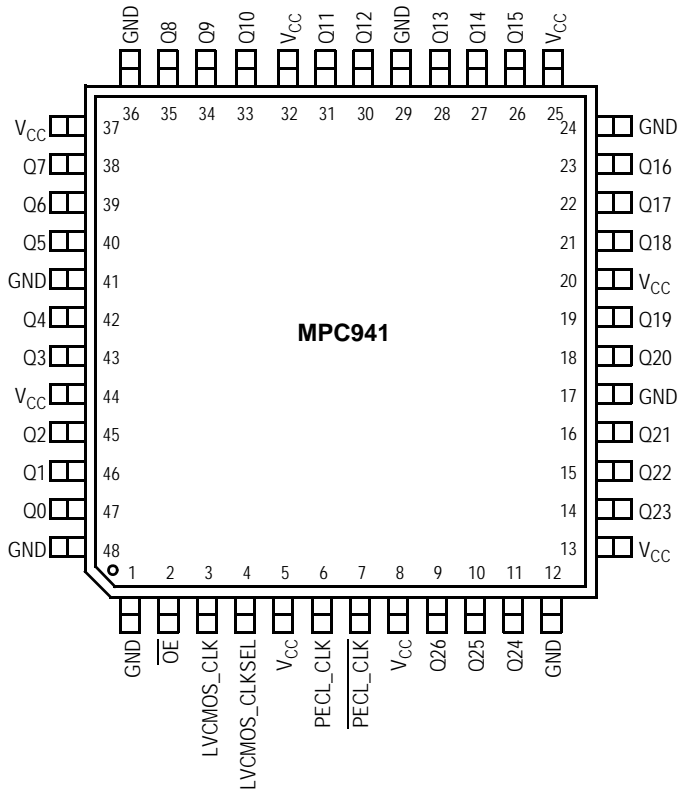

FUNCTION TABLE

LVC MOS_CLK_SEL	Input
0	PECL_CLK
1	LVC MOS_CLK

Table 1. Pin Configuration

Pin	I/O	Type	Function
PECL_CLK, PECL_CLK	Input	LVPECL	LVPECL differential reference clock inputs
LVC MOS_CLK	Input	LVC MOS	Alternative reference clock input
LVC MOS_CLK_SEL	Input	LVC MOS	Input reference clock select
OE	Input	LVC MOS	Output tristate control
GND		Supply	Negative voltage supply output bank (GND)
VCC		Supply	Positive voltage supply
Q0–Q26	Output	LVC MOS	Clock outputs

Table 2. Absolute Maximum Ratings⁽¹⁾

Symbol	Characteristics	Min	Max	Unit
V _{CC}	Supply Voltage	-0.3	3.6	V
V _{IN}	DC Input Voltage	-0.3	V _{CC} +0.3	V
V _{OUT}	DC Output Voltage	-0.3	V _{CC} +0.3	V
I _{IN}	DC Input Current		±20	mA
I _{OUT}	DC Output Current		±50	mA
T _S	Storage Temperature	-40	125	°C

1. Absolute maximum continuous ratings are those maximum values beyond which damage to the device may occur. Exposure to these conditions or conditions beyond those indicated may adversely affect device reliability. Functional operation under absolute-maximum-rated conditions is not implied.

Table 3. DC Characteristics (V_{CC} = 3.3 V ± 5%, T_A = -40 to +85°C)

Symbol	Characteristics	Min	Typ	Max	Unit	Condition
V _{IH}	Input High Voltage		2.0	V _{CC} + 0.3	V	LVC MOS
V _{IL}	Input Low Voltage	-0.3		0.8	V	LVC MOS
I _{IN}	Input Current			±120 ⁽¹⁾	μA	
V _{PP}	Peak-to-Peak Input Voltage	500			mV	LVPECL
V _{CMR}	Common Mode Range	1.2		V _{CC} - 0.8	V	LVPECL
V _{OH}	Output High Voltage	2.4			V	I _{OH} = -24 mA ⁽²⁾
V _{OL}	Output Low Voltage			0.55 0.40	V V	I _{OL} = 24 mA ⁽²⁾ I _{OL} = 12 mA
I _{OZ}	Output Tristate Leakage Current			100	μA	
Z _{OUT}	Output Impedance		14 – 17		Ω	
C _{PD}	Power Dissipation Capacitance		7-8	10	pF	Per Output
C _{IN}	Input Capacitance		4.0		pF	
I _{CCQ}	Maximum Quiescent Supply Current			5	mA	All V _{CC} Pins
V _{TT}	Output Termination Voltage		V _{CC} ÷ 2		V	

1. Input pull-up / pull-down resistors influence input current.
2. The MPC941 is capable of driving 50 Ω transmission lines on the incident edge. Each output drives one 50 Ω parallel terminated transmission line to a termination voltage of V_{TT}. Alternatively, the device drives up to two 50 Ω series terminated transmission lines.

Table 4. AC Characteristics ($V_{CC} = 3.3\text{ V} \pm 5\%$, $T_A = -40$ to $+85^\circ\text{C}$)⁽¹⁾

Symbol	Characteristics	Min	Typ	Max	Unit	Condition
f_{MAX}	Maximum Output Frequency	0		250 ⁽²⁾	MHz	
t_r, t_f	LVC MOS_CLK Input Rise/Fall Time			1.0 ⁽³⁾	ns	0.8 to 2.0 V
t_{PLH} t_{PHL}	Propagation Delay PECL_CLK to any Q LVC MOS_CLK to any Q	1.2 0.9	1.8 1.5	2.6 2.3	ns ns	
$t_{PLZ, HZ}$	Output Disable Time				ns	
$t_{PZL, LZ}$	Output Enable Time				ns	
$t_{sk(O)}$	Output-to-Output Skew PECL_CLK to any Q LVC MOS_CLK to any Q		125 125	250 250	ps	
$t_{sk(PP)}$	Device-to-Device Skew PECL_CLK to any Q LVC MOS_CLK to any Q			1000 1000	ps ps	For a given T_A and V_{CC} , any Q
$t_{sk(PP)}$	Device-to-Device Skew PECL_CLK to any Q LVC MOS_CLK to any Q			1400 1400	ps ps	For any T_A , V_{CC} and Q
DC _Q	Output Duty Cycle PECL_CLK to any Q LVC MOS_CLK to any Q	45 45	50 50	60 55	% %	DC _{REF} = 50% DC _{REF} = 50%
t_r, t_f	Output Rise/Fall Time	0.2		1.0	ns	0.55 to 2.4 V

- AC characteristics apply for parallel output termination of $50\ \Omega$ to V_{TT} .
- AC characteristics are guaranteed up to f_{max} . Please refer to applications section for information on power consumption versus operating frequency and thermal management.
- Fast input signal transition times are required to maintain part-to-part skew specification. If part-to-part skew is not critical to the application, signal transition times smaller than 3 ns can be applied to the MPC941.

Table 5. DC Characteristics ($V_{CC} = 2.5\text{ V} \pm 5\%$, $T_A = -40$ to $+85^\circ\text{C}$)

Symbol	Characteristics	Min	Typ	Max	Unit	Condition
V_{IH}	Input High Voltage LVC MOS_CLK	1.7		$V_{CC} + 0.3$	V	LVC MOS
V_{IL}	Input Low Voltage LVC MOS_CLK	-0.3		0.7	V	LVC MOS
I_{IN}	Input Current			± 120 ⁽¹⁾	μA	
V_{PP}	Peak-to-Peak Input Voltage PECL_CLK, PECL_CLK	500			mV	LVPECL
V_{CMR}	Common Mode Range PECL_CLK, PECL_CLK	1.1		$V_{CC} - 0.7$	V	LVPECL
V_{OH}	Output High Voltage	1.8			V	$I_{OH} = -15\text{ mA}$ ⁽²⁾
V_{OL}	Output Low Voltage			0.6	V	$I_{OL} = 15\text{ mA}$ ⁽²⁾
I_{OZ}	Output Tristate Leakage Current			100	μA	
Z_{OUT}	Output Impedance		18 – 20		Ω	
C_{PD}	Power Dissipation Capacitance		7 – 8	10	pF	Per Output
C_{IN}	Input Capacitance		4.0		pF	
I_{CCQ}	Maximum Quiescent Supply Current			5	mA	All V_{CC} Pins
V_{TT}	Output Termination Voltage		$V_{CC} \div 2$		V	

- Input pull-up / pull-down resistors influence input current.
- The MPC941 is capable of driving $50\ \Omega$ transmission lines on the incident edge. Each output drives one $50\ \Omega$ parallel terminated transmission line to a termination voltage of V_{TT} . Alternatively, the device drives up to two $50\ \Omega$ series terminated transmission lines.

Table 6. AC Characteristics ($V_{CC} = 2.5\text{ V} \pm 5\%$, $T_A = -40$ to $+85^\circ\text{C}$)(1)

Symbol	Characteristics	Min	Typ	Max	Unit	Condition
f_{MAX}	Maximum Output Frequency	0		250 ⁽²⁾	MHz	
t_r, t_f	LVCOSMOS_CLK Input Rise/Fall Time			1.0 ⁽³⁾	ns	0.7 to 1.7 V
t_{PLH} t_{PHL}	Propagation Delay PECL_CLK to any Q LVCOSMOS_CLK to any Q	1.3 1.0	2.1 1.8	2.9 2.6	ns ns	
$t_{PLZ, HZ}$	Output Disable Time				ns	
$t_{PZL, LZ}$	Output Enable Time				ns	
$t_{sk(O)}$	Output-to-Output Skew PECL_CLK to any Q LVCOSMOS_CLK to any Q		125 125	250 250	ps	
$t_{sk(PP)}$	Device-to-Device Skew PECL_CLK to any Q LVCOSMOS_CLK to any Q			1200 1200	ps ps	For a given T_A and V_{CC} , any Q
$t_{sk(PP)}$	Device-to-Device Skew PECL_CLK to any Q LVCOSMOS_CLK to any Q			1600 1600	ps ps	For any T_A , V_{CC} and Q
DC_Q	Output Duty Cycle PECL_CLK to any Q LVCOSMOS_CLK to any Q	45 45	50 50	60 55	% %	$DC_{REF} = 50\%$ $DC_{REF} = 50\%$
t_r, t_f	Output Rise/Fall Time	0.2		1.0	ns	0.6 to 1.6 V

- AC characteristics apply for parallel output termination of $50\ \Omega$ to V_{TT} .
- AC characteristics are guaranteed up to f_{MAX} . Please refer to the applications section for information on power consumption versus operating frequency and thermal management.
- Fast input signal transition times are required to maintain part-to-part skew specification. If part-to-part skew is not critical to the application, signal transition times smaller than 3 ns can be applied to the MPC941.

APPLICATIONS INFORMATION

Driving Transmission Lines

The MPC941 clock driver was designed to drive high-speed signals in a terminated transmission line environment. To provide the optimum flexibility to the user, the output drivers were designed to exhibit the lowest impedance possible. With an output impedance of less than 20 Ω, the drivers can drive either parallel or series terminated transmission lines. For more information on transmission lines, the reader is referred to Freescale application note AN1091 in the Timing Solutions data book (DL207/D).

In most high performance clock networks, point-to-point distribution of signals is the method of choice. In a point-to-point scheme, either series terminated or parallel terminated transmission lines can be used. The parallel technique terminates the signal at the end of the line with a 50 Ω resistance to V_{CC}/2. This technique draws a fairly high level of DC current, and thus, only a single terminated line can be driven by each output of the MPC941 clock driver. For the series terminated case, however, there is no DC current draw; thus, the outputs can drive multiple series terminated lines. Figure 1 illustrates an output driving a single series terminated line vs two series terminated lines in parallel.

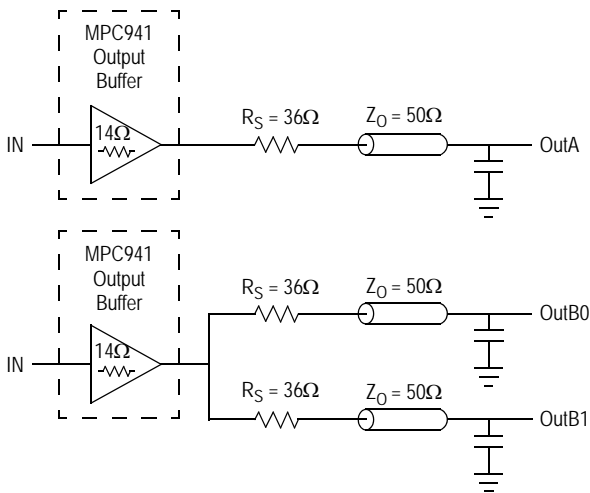

Figure 1. Single versus Dual Transmission Lines

The waveform plots of Figure 2 show the simulation results of an output driving a single line vs two lines. In both cases, the drive capability of the MPC941 output buffer is more than sufficient to drive 50 Ω transmission lines on the incident edge. Note from the delay measurements in the simulations, a delta of only 43 ps exists between the two differently loaded outputs. This suggests that the dual line driving need not be used exclusively to maintain the tight output-to-output skew of the MPC941. The output waveform in Figure 2 shows a step in the waveform. This step is caused by the impedance mismatch seen looking into the driver. The parallel combination of the 36 Ω series resistor plus the output impedance does not match the parallel combination of

the line impedances. The voltage wave launched down the two lines will equal:

$$V_L = V_S (Z_O / (R_S + R_O + Z_O))$$

$$Z_O = 50 \Omega \parallel 50 \Omega$$

$$R_S = 36 \Omega \parallel 36 \Omega$$

$$R_O = 14 \Omega$$

$$V_L = 3.0 (25 / (18 + 14 + 25)) = 3.0 (25 / 57)$$

$$= 1.31 \text{ V}$$

At the load end, the voltage will double, due to the near unity reflection coefficient, to 2.5 V. It will then increment towards the quiescent 3.0 V in steps separated by one round trip delay (in this case, 4.0 ns).

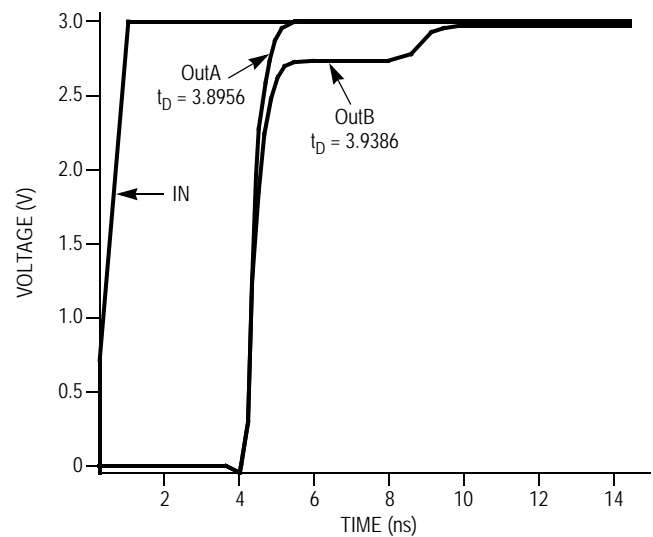

Figure 2. Single versus Dual Waveforms

Since this step is well above the threshold region, it will not cause any false clock triggering; however, designers may be uncomfortable with unwanted reflections on the line. To better match the impedances when driving multiple lines, the situation in Figure 3 should be used. In this case, the series terminating resistors are reduced such that when the parallel combination is added to the output impedance, the line impedance is perfectly matched.

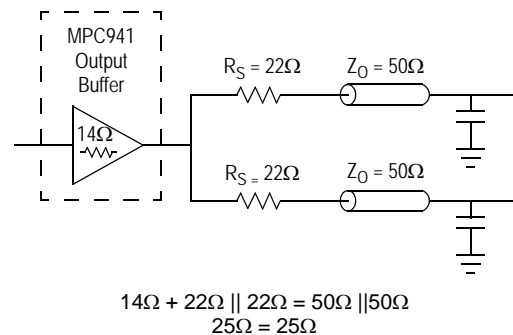

Figure 3. Optimized Dual Line Termination

Power Consumption of the MPC941 and Thermal Management

The MPC941 AC specification is guaranteed for the entire operating frequency range up to 250 MHz. The MPC941 power consumption and the associated long-term reliability may decrease the maximum frequency limit, depending on operating conditions such as clock frequency, supply voltage, output loading, ambient temperature, vertical convection and thermal conductivity of package and board. This section describes the impact of these parameters on the junction temperature and gives a guideline to estimate the MPC941 die junction temperature and the associated device reliability. For a complete analysis of power consumption as a function of operating conditions and associated long term device reliability, please refer to the [Freescale](#) application note AN1545. According the AN1545, the long-term device reliability is a function of the die junction temperature:

Table 7. Die Junction Temperature and MTBF

Junction Temperature (°C)	MTBF (Years)
100	20.4
110	9.1
120	4.2
130	2.0

Increased power consumption will increase the die junction temperature and impact the device reliability (MTBF). According to the system-defined tolerable MTBF, the die junction temperature of the MPC941 needs to be controlled, and the thermal impedance of the board/package should be optimized. The power dissipated in the MPC941 is represented in equation 1.

Where I_{CCQ} is the static current consumption of the MPC941, C_{PD} is the power dissipation capacitance per output. $(M)\sum C_L$ represents the external capacitive output load, and N is the number of active outputs (N is always 27 in case of the MPC941). The MPC941 supports driving transmission lines to maintain high signal integrity and tight timing parameters. Any transmission line will hide the lumped capacitive load at the end of the board trace, therefore, $\sum C_L$ is zero for controlled transmission line systems and can be eliminated from equation 1. Using parallel termination output termination results in equation 2 for power dissipation.

$$P_{TOT} = [I_{CCQ} + V_{CC} \cdot f_{CLOCK} \cdot (N \cdot C_{PD} + \sum_M C_L)] \cdot V_{CC} \quad \text{Equation 1}$$

$$P_{TOT} = V_{CC} \cdot [I_{CCQ} + V_{CC} \cdot f_{CLOCK} \cdot (N \cdot C_{PD} + \sum_M C_L)] + \sum_P [DC_Q \cdot I_{OH} \cdot (V_{CC} - V_{OH}) + (1 - DC_Q) \cdot I_{OL} \cdot V_{OL}] \quad \text{Equation 2}$$

$$T_J = T_A + P_{TOT} \cdot R_{thja} \quad \text{Equation 3}$$

$$f_{CLOCK,MAX} = \frac{1}{C_{PD} \cdot N \cdot V_{CC}^2} \cdot \left[\frac{T_{j,MAX} - T_A}{R_{thja}} - (I_{CCQ} \cdot V_{CC}) \right] \quad \text{Equation 4}$$

In equation 2, P stands for the number of outputs with a parallel or [thevenin](#) termination. V_{OL} , I_{OL} , V_{OH} and I_{OH} are a function of the output termination technique, and DC_Q is the clock signal duty cycle. If transmission lines are used, $\sum C_L$ is zero in equation 2 and can be eliminated. In general, the use of controlled transmission line techniques eliminates the impact of the lumped capacitive loads at the end lines and greatly reduces the power dissipation of the device. Equation 3 describes the die junction temperature T_J as a function of the power consumption.

Where R_{thja} is the thermal impedance of the package (junction to ambient), and T_A is the ambient temperature, according to [Table 7](#), the junction temperature can be used to estimate the long-term device reliability. Further, combining equation 1 and equation 2 results in a maximum operating frequency for the MPC941 in a series terminated transmission line system.

$T_{J,MAX}$ should be selected according to the MTBF system requirements, and [Table 7](#), R_{thja} can be derived from [Table 8](#). The R_{thja} represent data based on 1S2P boards. Using 2S2P boards will result in a lower thermal impedance than indicated below.

Table 8. Thermal Package Impedance of the 48ld LQFP

Convection, LFPM	R_{thja} (1P2S board), K/W
Still air	78
100 lfpm	68
200 lfpm	59
300 lfpm	56
400 lfpm	54
500 lfpm	53

If the calculated maximum frequency is below 250 MHz, it becomes the upper clock speed limit for the given application conditions. The following eight derating charts describe the safe frequency operation range for the MPC941. The charts were calculated for a maximum tolerable die junction temperature of 110°C (120°C), corresponding to a estimated MTBF of 9.1 years (4 years), a supply voltage of either 3.3 V or 2.5 V, and series terminated transmission line or capacitive loading. Depending on a given set of these operating conditions and the available device convection, a decision on the maximum operating frequency can be made.

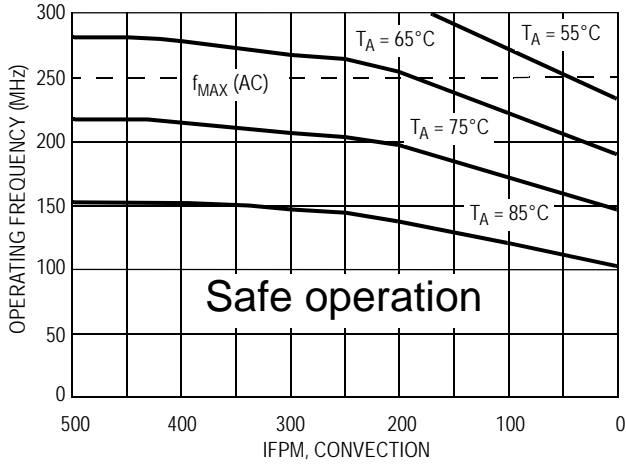

Figure 4. Maximum MPC941 frequency, $V_{CC} = 3.3\text{ V}$, MTBF 9.1 years, driving series terminated transmission lines

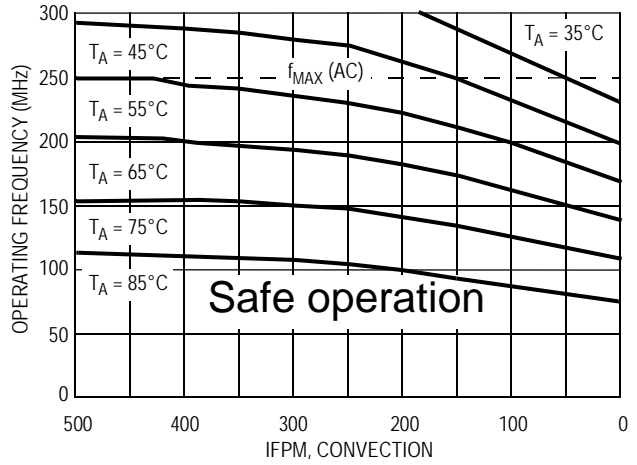

Figure 5. Maximum MPC941 frequency, $V_{CC} = 3.3\text{ V}$, MTBF 9.1 years, 4 pF load per line

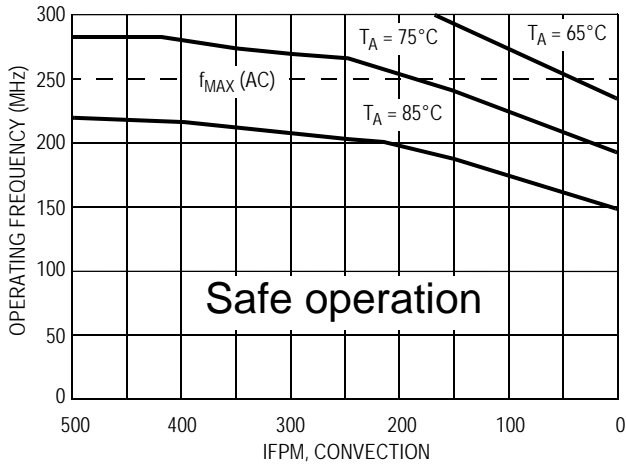

Figure 6. Maximum MPC941 frequency, $V_{CC} = 3.3\text{ V}$, MTBF 4 years, driving series terminated transmission lines

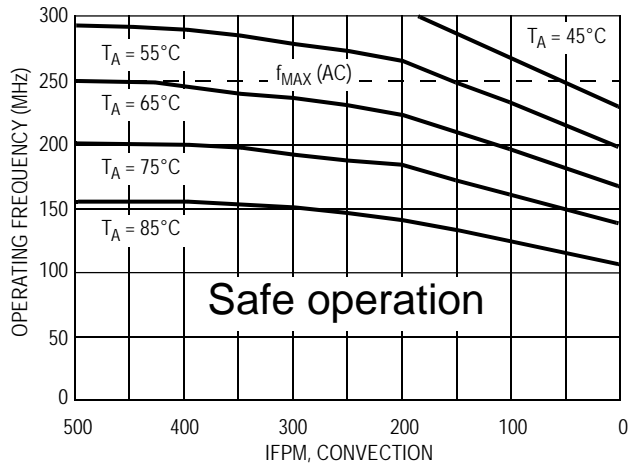
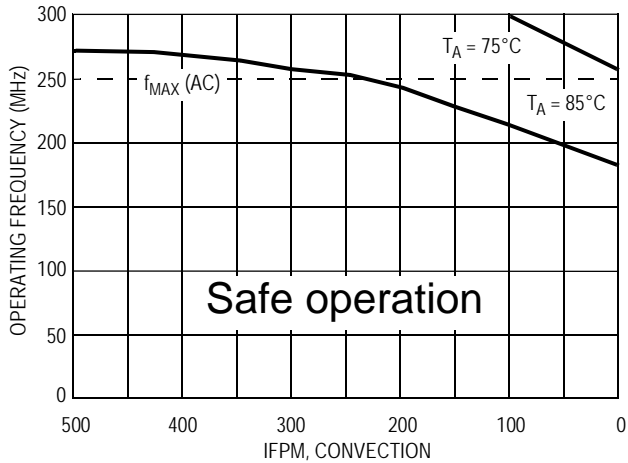
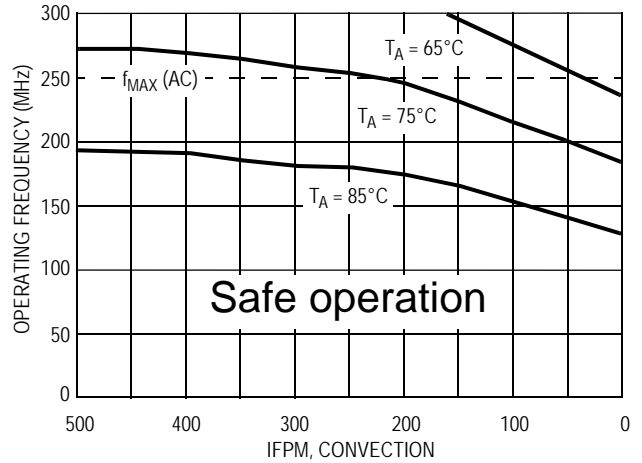

Figure 7. Maximum MPC941 frequency, $V_{CC} = 3.3\text{ V}$, MTBF 4 years, 4 pF load per line



**Figure 8. Maximum MPC941 frequency,
V_{CC} = 2.5 V, MTBF 9.1 years,
driving series terminated transmission lines**



**Figure 9. Maximum MPC941 frequency,
V_{CC} = 2.5 V, MTBF 9.1 years,
4 pF load per line**

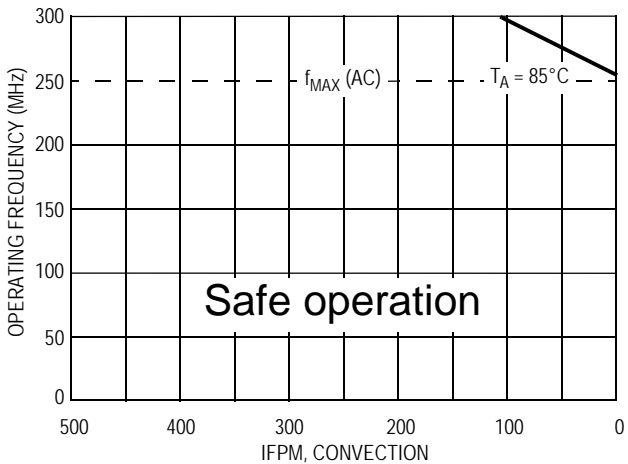

**Figure 10. Maximum MPC941 frequency,
V_{CC} = 2.5 V, MTBF 4 years,
driving series terminated transmission lines**

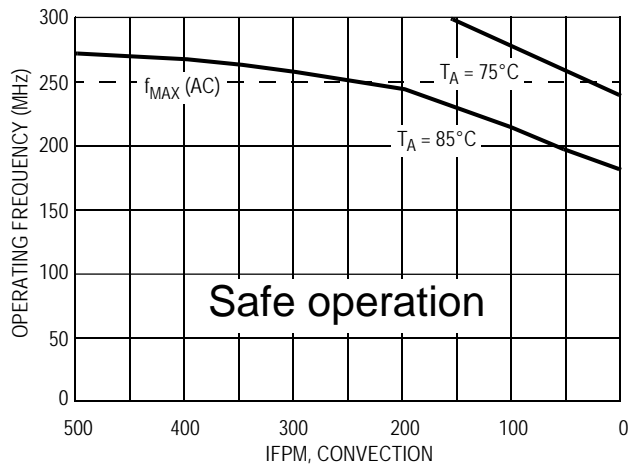

**Figure 11. Maximum MPC941 frequency,
V_{CC} = 2.5 V, MTBF 4 years,
4 pF load per line**

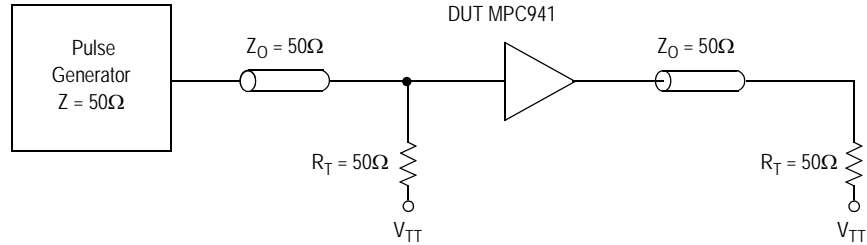

Figure 12. LVC MOS_CLK MPC941 AC Test Reference for $V_{CC} = 3.3\text{ V}$ and $V_{CC} = 2.5\text{ V}$

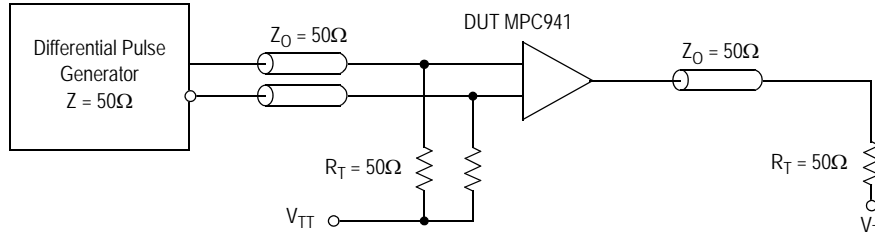

Figure 13. PECL_CLK MPC941 AC Test Reference for $V_{CC} = 3.3\text{ V}$ and $V_{CC} = 2.5\text{ V}$

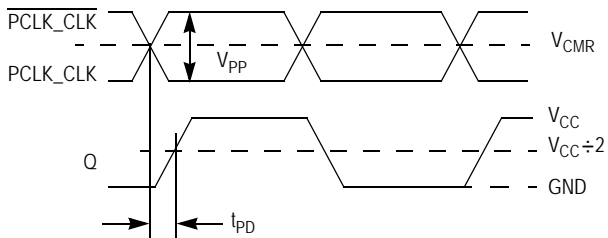

Figure 14. LVPECL Propagation Delay (t_{PD}) Test Reference

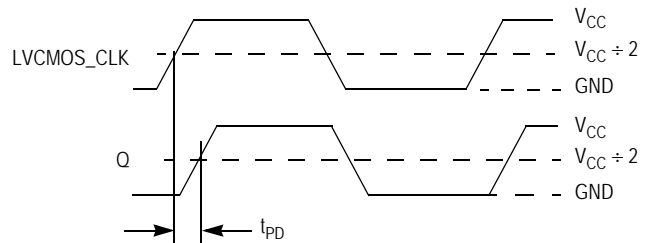
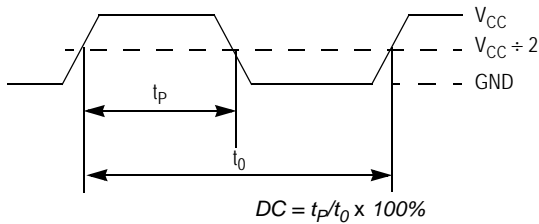
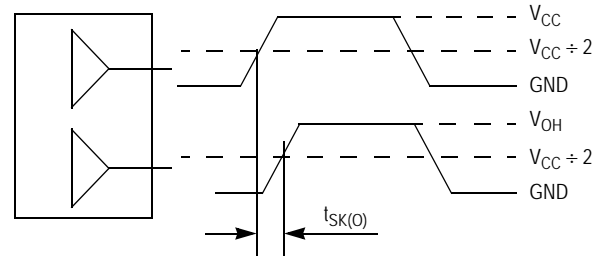

Figure 15. LVC MOS Propagation Delay (t_{PD}) Test Reference



The time from the PLL controlled edge to the non controlled edge, divided by the time between PLL controlled edges, expressed as a percentage

Figure 16. Output Duty Cycle (DC)



The pin-to-pin skew is defined as the worst case difference in propagation delay between any two similar delay path within a single device

Figure 17. Output-to-Output Skew $t_{SK(O)}$

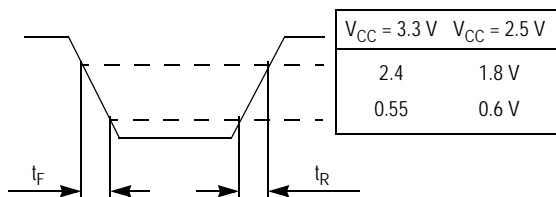

Figure 18. Output Transition Time Test Reference

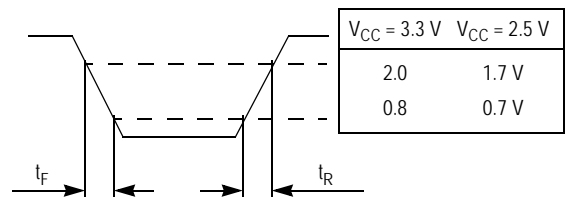
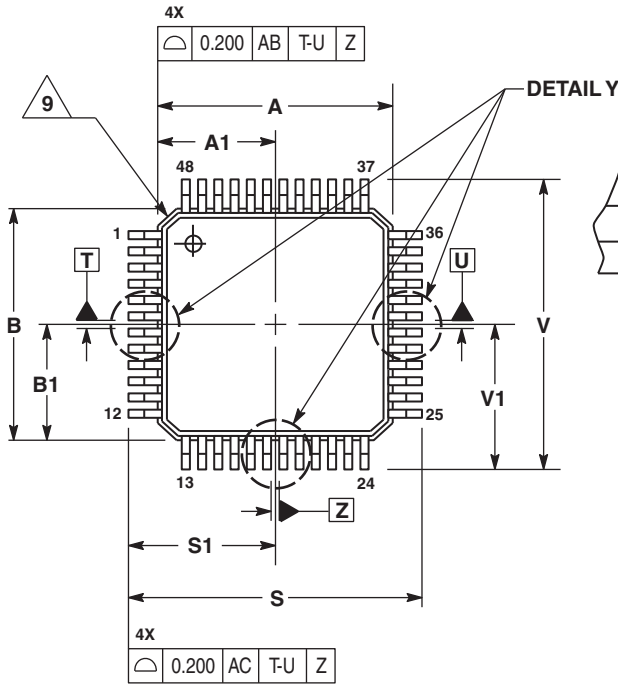

Figure 19. Input Transition Time Test Reference

PACKAGE DIMENSIONS



NOTES:

1. DIMENSIONING AND TOLERANCING PER ASME Y14.5m, 1994.
2. CONTROLLING DIMENSION: MILLIMETER.
3. DATUM PLAN AB IS LOCATED AT BOTTOM OF LEAD AND IS COINCIDENT WITH THE LEAD WHERE THE LEAD EXITS THE PLASTIC BODY AT THE BOTTOM OF THE PARTING LINE.
4. DATUMS T, U, AND Z TO BE DETERMINED AT DATAUM PLANE AB.
5. DIMENSIONS S AND V TO BE DETERMINED AT SEATING PLANE AC.
6. DIMENSIONS A AND B DO NOT INCLUDE MOLD PROTRUSION. ALLOWABLE PROTRUSION IS 0.250 PER SIDE. DIMENSIONS A AND B DO INCLUDE MOLD MISMATCH AND ARE DETERMINED AT DATUM PLANE AB.
7. DIMENSION D DOES NOT INCLUDE DAMBAR PROTRUSION. DAMBAR PROTRUSION SHALL NOT CAUSE THE D DIMENSION TO EXCEED 0.350.
8. MINIMUM SOLDER PLATE THICKNESS SHALL BE 0.0076.
9. EXACT SHAPE OF EACH CORNER IS OPTIONAL.

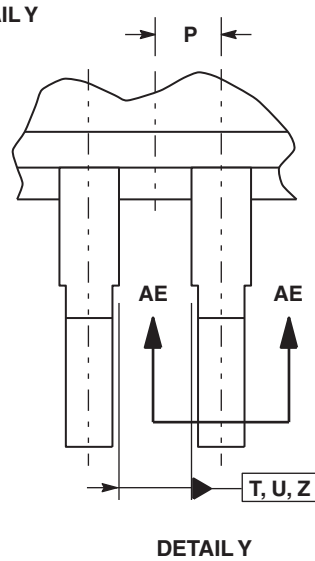

MILLIMETERS		
DIM	MIN	MAX
A	7.000	BSC
A1	3.500	BSC
B	7.000	BSC
B1	3.500	BSC
C	1.400	1.600
D	0.170	0.270
E	1.350	1.450
F	0.170	0.230
G	0.500 BSC	
H	0.050	0.150
J	0.090	0.200
K	0.500	0.700
L	0°	7°
M	12° REF	
N	0.090	0.160
P	0.250 BSC	
R	0.150	0.250
S	9.000 BSC	
S1	4.500 BSC	
V	9.000 BSC	
V1	4.500 BSC	
W	0.200 REF	
AA	1.000 REF	

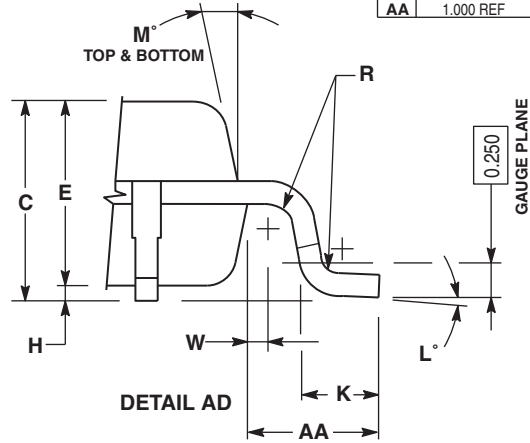
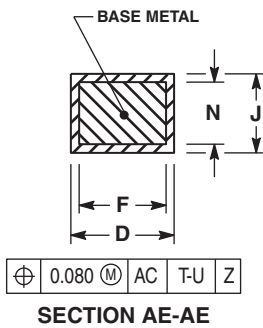
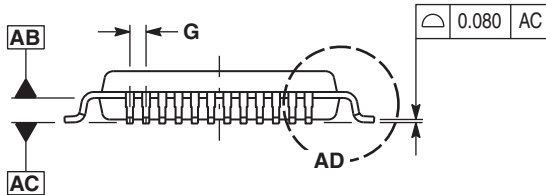

CASE 932-03
 ISSUE F
 48-LEAD LQFP PACKAGE

Revision History Sheet

Rev	Table	Page	Description of Change	Date
9		1	NRND – Not Recommend for New Designs	1/7/13
10		1	Removed NRND and updated the format of the data sheet	3/18/15



Corporate Headquarters
6024 Silver Creek Valley Road
San Jose, CA 95138 USA

Sales
1-800-345-7015 or 408-284-8200
Fax: 408-284-2775
www.IDT.com

Tech Support
email: clocks@idt.com

DISCLAIMER Integrated Device Technology, Inc. (IDT) and its subsidiaries reserve the right to modify the products and/or specifications described herein at any time and at IDT's sole discretion. All information in this document, including descriptions of product features and performance, is subject to change without notice. Performance specifications and the operating parameters of the described products are determined in the independent state and are not guaranteed to perform the same way when installed in customer products. The information contained herein is provided without representation or warranty of any kind, whether express or implied, including, but not limited to, the suitability of IDT's products for any particular purpose, an implied warranty of merchantability, or non-infringement of the intellectual property rights of others. This document is presented only as a guide and does not convey any license under intellectual property rights of IDT or any third parties.

IDT's products are not intended for use in applications involving extreme environmental conditions or in life support systems or similar devices where the failure or malfunction of an IDT product can be reasonably expected to significantly affect the health or safety of users. Anyone using an IDT product in such a manner does so at their own risk, absent an express, written agreement by IDT.

While the information presented herein has been checked for both accuracy and reliability, Integrated Device Technology (IDT) assumes no responsibility for either its use or for the infringement of any patents or other rights of third parties, which would result from its use. No other circuits, patents, or licenses are implied. This product is intended for use in normal commercial applications. Any other applications, such as those requiring extended temperature ranges, high reliability or other extraordinary environmental requirements are not recommended without additional processing by IDT. IDT reserves the right to change any circuitry or specifications without notice. IDT does not authorize or warrant any IDT product for use in life support devices or critical medical instruments.

Integrated Device Technology, IDT and the IDT logo are registered trademarks of IDT. Product specification subject to change without notice. Other trademarks and service marks used herein, including protected names, logos and designs, are the property of IDT or their respective third party owners.

Copyright ©2015 Integrated Device Technology, Inc.. All rights reserved.



Компания «ЭлектроПласт» предлагает заключение долгосрочных отношений при поставках импортных электронных компонентов на взаимовыгодных условиях!

Наши преимущества:

- Оперативные поставки широкого спектра электронных компонентов отечественного и импортного производства напрямую от производителей и с крупнейших мировых складов;
- Поставка более 17-ти миллионов наименований электронных компонентов;
- Поставка сложных, дефицитных, либо снятых с производства позиций;
- Оперативные сроки поставки под заказ (от 5 рабочих дней);
- Экспресс доставка в любую точку России;
- Техническая поддержка проекта, помощь в подборе аналогов, поставка прототипов;
- Система менеджмента качества сертифицирована по Международному стандарту ISO 9001;
- Лицензия ФСБ на осуществление работ с использованием сведений, составляющих государственную тайну;
- Поставка специализированных компонентов (Xilinx, Altera, Analog Devices, Intersil, Interpoint, Microsemi, Aeroflex, Peregrine, Syfer, Eurofarad, Texas Instrument, Miteq, Cobham, E2V, MA-COM, Hittite, Mini-Circuits, General Dynamics и др.);

Помимо этого, одним из направлений компании «ЭлектроПласт» является направление «Источники питания». Мы предлагаем Вам помощь Конструкторского отдела:

- Подбор оптимального решения, техническое обоснование при выборе компонента;
- Подбор аналогов;
- Консультации по применению компонента;
- Поставка образцов и прототипов;
- Техническая поддержка проекта;
- Защита от снятия компонента с производства.



Как с нами связаться

Телефон: 8 (812) 309 58 32 (многоканальный)

Факс: 8 (812) 320-02-42

Электронная почта: org@eplast1.ru

Адрес: 198099, г. Санкт-Петербург, ул. Калинина, дом 2, корпус 4, литера А.