

# General Specifications

## Electrical Capacity (Resistive Load)

<b>Power Level (silver):</b>	3A @ 125V AC for silver contacts
<b>Logic Level (gold):</b>	0.4VA maximum @ 28V AC/DC maximum for gold contacts (Applicable Range 0.1mA ~ 0.1A @ 20mV ~ 28V) Note: Find additional explanation of operating range in Supplement section.

## Other Ratings

<b>Contact Resistance:</b>	10 milliohms maximum for silver; 20 milliohms maximum for gold
<b>Insulation Resistance:</b>	1,000 megohms minimum @ 500V DC
<b>Dielectric Strength:</b>	1,000V AC minimum between contacts for 1 minute minimum; 1,500V AC minimum between contacts and case for 1 minute minimum
<b>Mechanical Life:</b>	100,000 operations minimum
<b>Electrical Life:</b>	25,000 operations minimum for silver; 50,000 operations minimum for gold
<b>Nominal Operating Force:</b>	Single Pole: 2.35N for Momentary and 2.65N for Alternate Action Double Pole: 2.94N for Momentary and 3.63N for Alternate Action
<b>Travel:</b>	Momentary: Pretravel .047" (1.2mm); Overtravel .016" (0.4mm); Total Travel .063" (1.6mm) Alternate: Pretravel .071" (1.8mm); Overtravel .016" (0.4mm); Total Travel .087" (2.2mm)

## Materials & Finishes

<b>Plunger:</b>	Brass with chrome plating for Momentary; brass with nickel plating for Alternate
<b>Bushing:</b>	Brass with nickel plating
<b>Frame:</b>	Stainless steel
<b>Case:</b>	Melamine phenolic resin (UL94V-0)
<b>Movable Contacts:</b>	Copper with silver or gold plating
<b>Stationary Contacts:</b>	Silver with silver or gold plating
<b>Terminals:</b>	Copper with silver or gold plating

## Environmental Data

<b>Operating Temp Range:</b>	-10°C through +70°C (+14°F through +158°F)
<b>Humidity:</b>	90 ~ 95% humidity for 96 hours @ 40°C (104°F)
<b>Vibration:</b>	10 ~ 55Hz with peak-to-peak amplitude of 1.5mm traversing the frequency range & returning in 1 minute; 3 right angled directions for 2 hours
<b>Shock:</b>	50G (490m/s <sup>2</sup> ) acceleration (tested in 6 right angled directions, with 5 shocks in each direction)

## Installation

<b>Mounting Torque:</b>	1.47Nm (13.0 lb•in) for double nut; 0.68Nm (6.0 lb•in) for single nut
<b>Cap Installation Force:</b>	78.5N (17.65 lbf) maximum downward force on actuator
<b>Soldering Time &amp; Temp:</b>	Wave Solder (Straight PC): See Profile B in Supplement section. Manual Soldering: See Profile B in Supplement section.
<b>Cleaning:</b>	These devices are not process sealed. Hand clean locally using alcohol based solution.

## Standards & Certifications

<b>Flammability Standards:</b>	UL94V-0 case
<b>UL:</b>	<b>File No. E44145 - Recognized only when ordered with marking on switch.</b> Add "/U" or "/CUL" before first dash in part number to order UL recognized switch. All single and double pole models recognized at 3A @ 125V AC.
<b>CSA:</b>	<b>File No. 023535_0_000 - Certified only when ordered with marking on switch.</b> Add "/C" before first dash in part number to order CSA certified switch. Single pole solder lug and PC models certified at 3A @ 125V AC; double pole PC models certified at 3A @ 125V AC.

# Distinctive Characteristics

Power and logic level capabilities available to suit varying applications.

Bushing and snap-in mount versions available; snap-in models offer many style and color choices to enhance front panel appearance.

Light touch actuation.

High torque bushing prevents rotation and separation from metal frame during installation.

Stainless steel frame resists corrosion.

Case of heat resistant resin meets UL 94V-0 flammability rating.

Higher insulating barriers protect against crossover in double pole devices.

1,500V dielectric strength between contacts and case is accomplished by clinching the frame away from the terminals.

Epoxy sealed terminals prevent entry of solder flux and other contaminants.

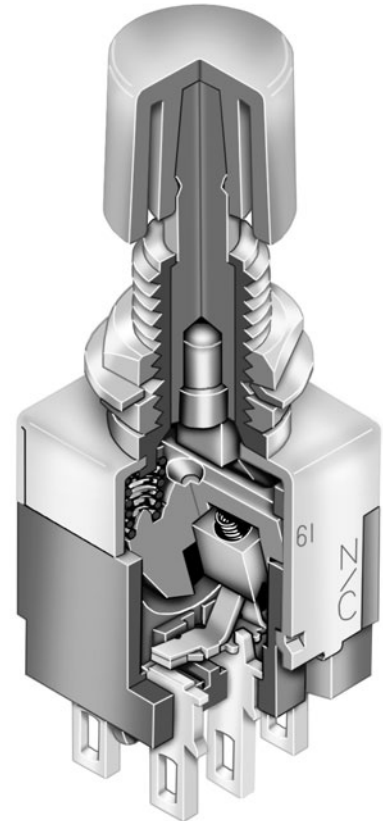

Actual Size

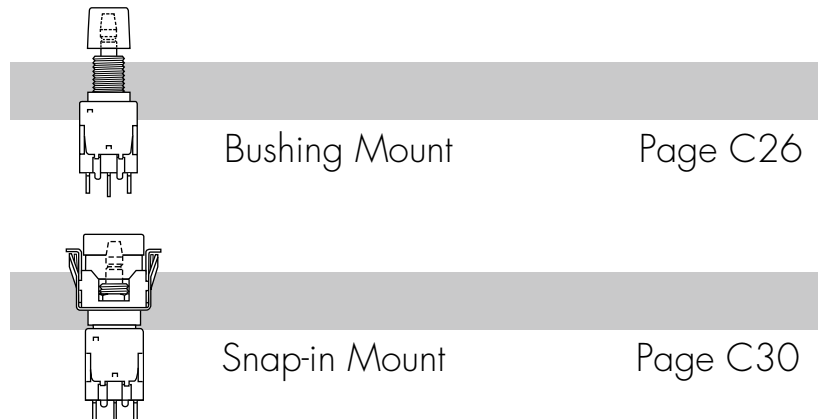
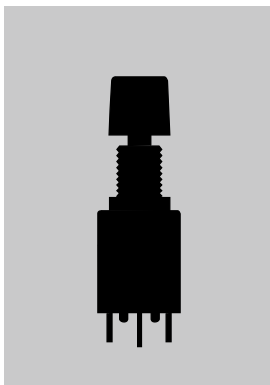

- Supplement
- Accessories
- Indicators
- Touch
- Tilt
- Tactiles
- Slides
- Rotaries
- Keylocks
- Programmable
- Illuminated PB
- Pushbuttons
- Rockers
- Toggles

### TYPICAL SWITCH ORDERING EXAMPLE

EB20

65

B

F

#### Poles & Circuits

11	SPDT	ON	(ON)
65	SPDT	ON	ON
61	DPDT	ON	(ON)
85	DPDT	ON	ON

( ) = Momentary

#### Caps

B	.315" (8.0mm) Dia.
C	.394" (10.0mm) Dia.

#### Contacts, Ratings, & Terminals

No Code	Silver Contacts; Solder Lug Terminals* 3A @ 125V AC
G	Gold Contacts; Solder Lug Terminals* 0.4VA max @ 28V AC/DC max
P	Silver Contacts; Straight PC Terminals; 3A @ 125V AC
PG	Gold Contacts; Straight PC Terminals 0.4VA max @ 28V AC/DC max

#### Colors

A	Black
B	White
C	Red
E	Yellow
F	Green
G	Blue
H	Gray

#### IMPORTANT:



Switches are supplied without UL, cULus & CSA marking unless specified. **UL, cULus & CSA recognized only when ordered with marking on the switch.** Specific models, ratings, & ordering instructions are noted on General Specifications page.



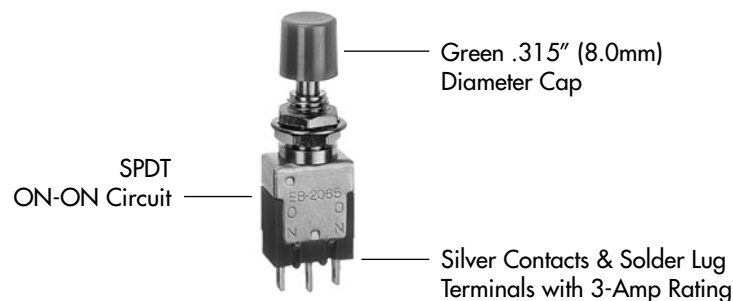

\* Wire harness & cable assemblies offered only in Americas

#### DESCRIPTION FOR TYPICAL ORDERING EXAMPLE

EB2065-BF

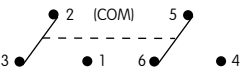

## POLES & CIRCUITS

Pole	Model	Plunger Position ( ) = Momentary		Connected Terminals		Throw & Switch Schematics
		Normal  Keyway	Down 	Normal  Keyway	Down 	
SP	EB2011 EB2065	ON ON	(ON) ON	2-3	2-1	SPDT 
DP	EB2061 EB2085	ON ON	(ON) ON	2-3 5-6	2-1 5-4	DPDT 

Note: Terminal numbers are not actually on the switch.

## CONTACT MATERIALS, RATINGS, & TERMINALS



**Solder Lug  
Silver Contacts**

**Power Level**

**3A @ 125V AC**



**Solder Lug  
Gold Contacts**

**Logic Level**

**0.4VA max @ 28V AC/DC max**

Complete explanation of operating range in Supplement section.

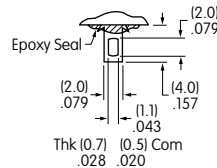

**Straight PC  
Silver Contacts**

**Power Level**

**3A @ 125V AC**



**Straight PC  
Gold Contacts**

**Logic Level**

**0.4VA max @ 28V AC/DC max**

Complete explanation of operating range in Supplement section.

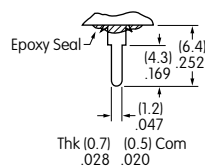

### PCB Footprints

Single Pole

Double Pole

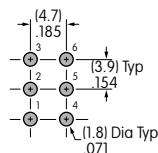
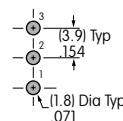

## CAPS & COLORS

**B** AT443  
.315" (8.0mm) Diameter Snap-on Cap

**C** AT442  
.394" (10.0mm) Diameter Snap-on Cap

Cap Colors Available:

- |                 |                |
|-----------------|----------------|
| <b>A</b> Black  | <b>F</b> Green |
| <b>B</b> White  | <b>G</b> Blue  |
| <b>C</b> Red    | <b>H</b> Gray  |
| <b>E</b> Yellow |                |

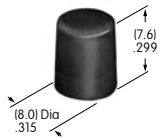

Cap Colors Available:

- |                 |                |
|-----------------|----------------|
| <b>A</b> Black  | <b>F</b> Green |
| <b>B</b> White  | <b>G</b> Blue  |
| <b>C</b> Red    | <b>H</b> Gray  |
| <b>E</b> Yellow |                |

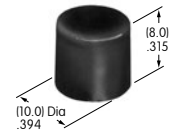

Cap Material: Polycarbonate Finish: Glossy

Cap Material: Polycarbonate Finish: Glossy

### Plunger Extension

Due to a difference in plunger lengths on the momentary and alternate action models, cap distance from top of bushing varies.

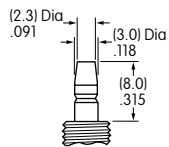

Momentary Plunger Length

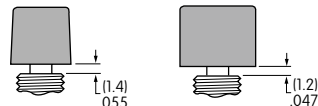

Momentary Cap Location

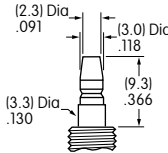

Alternate Plunger Length

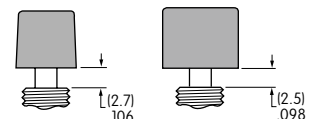

Alternate Cap Location

## TYPICAL SWITCH DIMENSIONS

### Solder Lug

### Single Pole



EB2011-BA

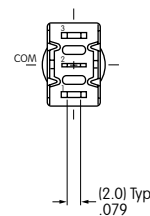
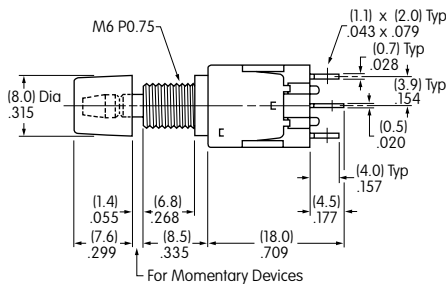
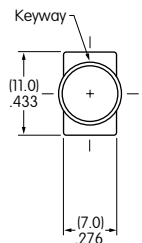

### Solder Lug

### Double Pole



EB2061-BA

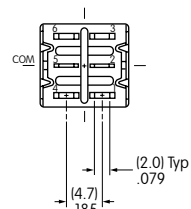
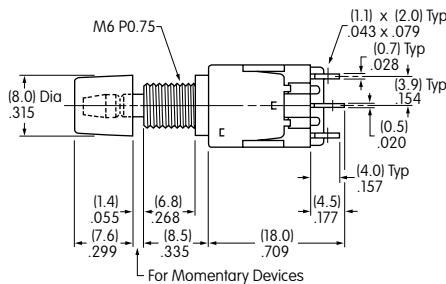
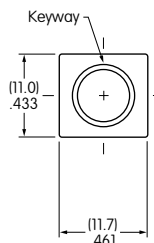

## HARDWARE

### Installation/Assembly

- 2 AT513M Metric Hexagon Nuts
- 1 AT509 Internal Tooth Lockwasher

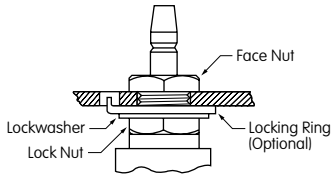

Optional Hardware:  
AT507M Metric Locking Ring

Note: Cap must be snapped on after the switch is mounted into the panel.

### Standard Hardware

#### AT513M Metric Hexagon Nut

Material:  
Brass with  
Nickel Plating

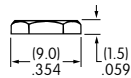
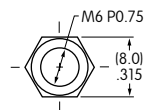

#### AT509 Lockwasher

Material:  
Steel with  
Zinc/Chromate

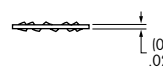
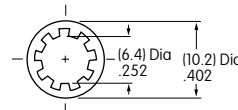

### Optional Hardware

#### AT507M Metric Locking Ring

Material:  
Steel with  
Zinc/Chromate

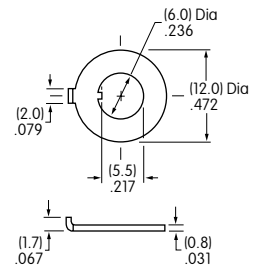

## PANEL CUTOUTS & THICKNESSES

### Metric Bushing

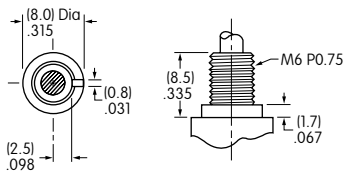

### With Standard Hardware

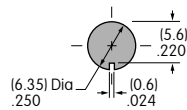

Maximum Effective  
Panel Thickness:  
.118" (3.0mm)

### With Standard Hardware & Optional Locking Ring

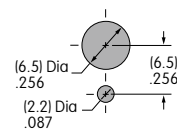

Maximum Effective  
Panel Thickness:  
.055" (1.4mm)

### Without Bottom Hex Nut

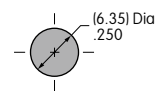

Maximum Effective  
Panel Thickness:  
.185" (4.7mm)

See Accessories & Hardware section for optional Conical Nuts:  
AT512M used with cap AT443 and AT512CM used with cap AT442.



Компания «ЭлектроПласт» предлагает заключение долгосрочных отношений при поставках импортных электронных компонентов на взаимовыгодных условиях!

Наши преимущества:

- Оперативные поставки широкого спектра электронных компонентов отечественного и импортного производства напрямую от производителей и с крупнейших мировых складов;
- Поставка более 17-ти миллионов наименований электронных компонентов;
- Поставка сложных, дефицитных, либо снятых с производства позиций;
- Оперативные сроки поставки под заказ (от 5 рабочих дней);
- Экспресс доставка в любую точку России;
- Техническая поддержка проекта, помощь в подборе аналогов, поставка прототипов;
- Система менеджмента качества сертифицирована по Международному стандарту ISO 9001;
- Лицензия ФСБ на осуществление работ с использованием сведений, составляющих государственную тайну;
- Поставка специализированных компонентов (Xilinx, Altera, Analog Devices, Intersil, Interpoint, Microsemi, Aeroflex, Peregrine, Syfer, Eurofarad, Texas Instrument, Miteq, Cobham, E2V, MA-COM, Hittite, Mini-Circuits, General Dynamics и др.);

Помимо этого, одним из направлений компании «ЭлектроПласт» является направление «Источники питания». Мы предлагаем Вам помощь Конструкторского отдела:

- Подбор оптимального решения, техническое обоснование при выборе компонента;
- Подбор аналогов;
- Консультации по применению компонента;
- Поставка образцов и прототипов;
- Техническая поддержка проекта;
- Защита от снятия компонента с производства.



#### Как с нами связаться

**Телефон:** 8 (812) 309 58 32 (многоканальный)

**Факс:** 8 (812) 320-02-42

**Электронная почта:** [org@eplast1.ru](mailto:org@eplast1.ru)

**Адрес:** 198099, г. Санкт-Петербург, ул. Калинина, дом 2, корпус 4, литера А.