

**Buck chopper
Trench + Field Stop IGBT®
Power Module**

**$V_{CES} = 1700V$
 $I_C = 300A @ T_c = 80^\circ C$**

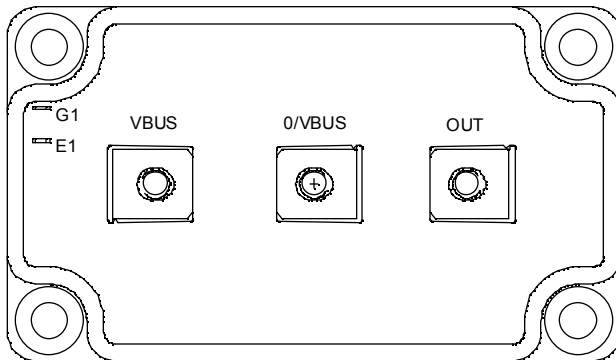
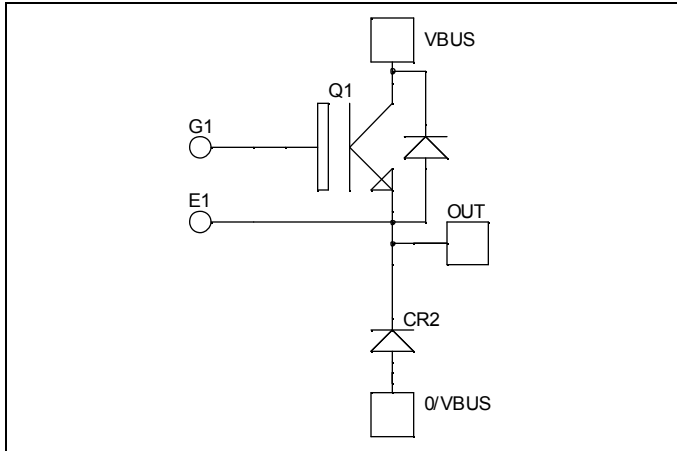

Application

- AC and DC motor control
- Switched Mode Power Supplies

Features

- Trench + Field Stop IGBT® Technology
 - Low voltage drop
 - Low tail current
 - Switching frequency up to 20 kHz
 - Soft recovery parallel diodes
 - Low diode VF
 - Low leakage current
 - Avalanche energy rated
 - RBSOA and SCSOA rated
- Kelvin emitter for easy drive
- Very low stray inductance
 - Symmetrical design
 - M5 power connectors
- High level of integration

Benefits

- Stable temperature behavior
- Very rugged
- Direct mounting to heatsink (isolated package)
- Low junction to case thermal resistance
- Easy paralleling due to positive TC of VCEsat
- Low profile
- RoHS Compliant

Absolute maximum ratings

| Symbol | Parameter | Max ratings | Unit |
|-----------|---------------------------------------|---------------------|--------------|
| V_{CES} | Collector - Emitter Breakdown Voltage | 1700 | V |
| I_C | Continuous Collector Current | $T_c = 25^\circ C$ | 400 |
| | | $T_c = 80^\circ C$ | 300 |
| I_{CM} | Pulsed Collector Current | $T_c = 25^\circ C$ | 600 |
| V_{GE} | Gate - Emitter Voltage | ± 20 | V |
| P_D | Maximum Power Dissipation | $T_c = 25^\circ C$ | 1660 |
| RBSOA | Reverse Bias Safe Operating Area | $T_j = 125^\circ C$ | 600A @ 1600V |

CAUTION: These Devices are sensitive to Electrostatic Discharge. Proper Handling Procedures Should Be Followed. See application note APT0502 on www.microsemi.com

All ratings @ $T_j = 25^\circ\text{C}$ unless otherwise specified

Electrical Characteristics

| Symbol | Characteristic | Test Conditions | Min | Typ | Max | Unit |
|---------------|--------------------------------------|--|---------------------------|-----|-----|---------------|
| I_{CES} | Zero Gate Voltage Collector Current | $V_{GE} = 0\text{V}, V_{CE} = 1700\text{V}$ | | | 750 | μA |
| $V_{CE(sat)}$ | Collector Emitter Saturation Voltage | $V_{GE} = 15\text{V}$ $I_C = 300\text{A}$ | $T_j = 25^\circ\text{C}$ | 2.0 | 2.4 | V |
| | | | $T_j = 125^\circ\text{C}$ | 2.4 | | |
| $V_{GE(th)}$ | Gate Threshold Voltage | $V_{GE} = V_{CE}, I_C = 5\text{mA}$ | 5.0 | 5.8 | 6.5 | V |
| I_{GES} | Gate – Emitter Leakage Current | $V_{GE} = 20\text{V}, V_{CE} = 0\text{V}$ | | | 600 | nA |

Dynamic Characteristics

| Symbol | Characteristic | Test Conditions | Min | Typ | Max | Unit |
|--------------|------------------------------|--|---------------------------|------|-----|------|
| C_{ies} | Input Capacitance | $V_{GE} = 0\text{V}$ | | 26.5 | | nF |
| C_{oes} | Output Capacitance | $V_{CE} = 25\text{V}$ | | 1.1 | | |
| C_{res} | Reverse Transfer Capacitance | $f = 1\text{MHz}$ | | 0.88 | | |
| $T_{d(on)}$ | Turn-on Delay Time | Inductive Switching (25°C) | | 370 | | ns |
| T_r | Rise Time | $V_{GE} = 15\text{V}$ | | 40 | | |
| $T_{d(off)}$ | Turn-off Delay Time | $V_{Bus} = 900\text{V}$ | | 650 | | |
| T_f | Fall Time | $I_C = 300\text{A}$ $R_G = 2.2\Omega$ | | 180 | | |
| $T_{d(on)}$ | Turn-on Delay Time | Inductive Switching (125°C) | | 400 | | ns |
| T_r | Rise Time | $V_{GE} = 15\text{V}$ | | 50 | | |
| $T_{d(off)}$ | Turn-off Delay Time | $V_{Bus} = 900\text{V}$ | | 800 | | |
| T_f | Fall Time | $I_C = 300\text{A}$ $R_G = 2.2\Omega$ | | 300 | | |
| E_{on} | Turn-on Switching Energy | $V_{GE} = 15\text{V}$ $V_{Bus} = 900\text{V}$ | $T_j = 125^\circ\text{C}$ | 96 | | mJ |
| E_{off} | Turn-off Switching Energy | $I_C = 300\text{A}$ $R_G = 2.2\Omega$ | $T_j = 125^\circ\text{C}$ | 94 | | |

Chopper diode ratings and characteristics

| Symbol | Characteristic | Test Conditions | Min | Typ | Max | Unit |
|-----------|---|--|---------------------------|-----|------|---------------|
| V_{RRM} | Maximum Peak Repetitive Reverse Voltage | | 1700 | | | V |
| I_{RM} | Maximum Reverse Leakage Current | $V_R = 1700\text{V}$ | $T_j = 25^\circ\text{C}$ | | 750 | μA |
| | | | $T_j = 125^\circ\text{C}$ | | 1000 | |
| I_F | DC Forward Current | | $T_c = 80^\circ\text{C}$ | 300 | | A |
| V_F | Diode Forward Voltage | $I_F = 300\text{A}$ | $T_j = 25^\circ\text{C}$ | 1.8 | 2.2 | V |
| | | | $T_j = 125^\circ\text{C}$ | 1.9 | | |
| t_{rr} | Reverse Recovery Time | $I_F = 300\text{A}$ $V_R = 900\text{V}$ $di/dt = 3200\text{A}/\mu\text{s}$ | $T_j = 25^\circ\text{C}$ | 385 | | ns |
| | | | $T_j = 125^\circ\text{C}$ | 490 | | |
| Q_{rr} | Reverse Recovery Charge | | $T_j = 25^\circ\text{C}$ | 76 | | μC |
| | | | $T_j = 125^\circ\text{C}$ | 124 | | |
| E_r | Reverse Recovery Energy | | $T_j = 25^\circ\text{C}$ | 35 | | mJ |
| | | | $T_j = 125^\circ\text{C}$ | 70 | | |

Typical Performance Curve

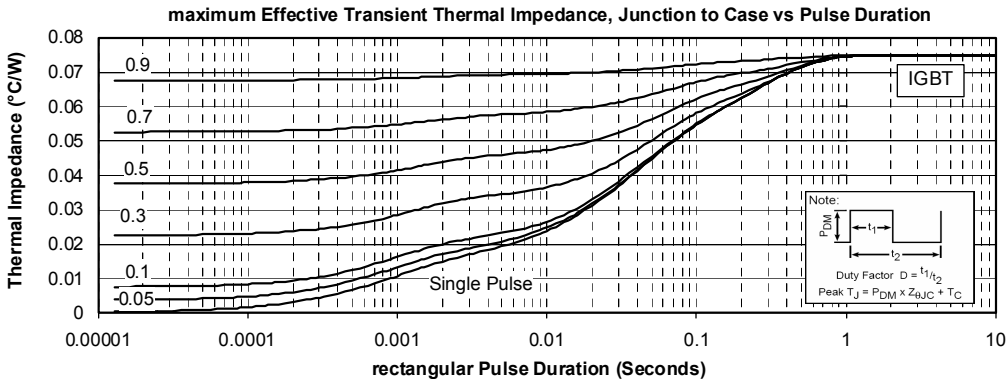
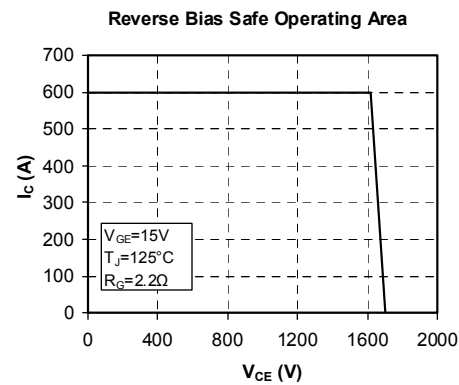
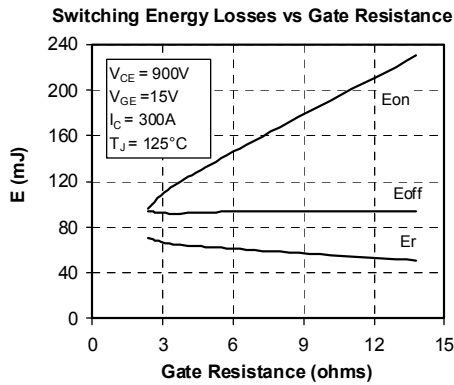
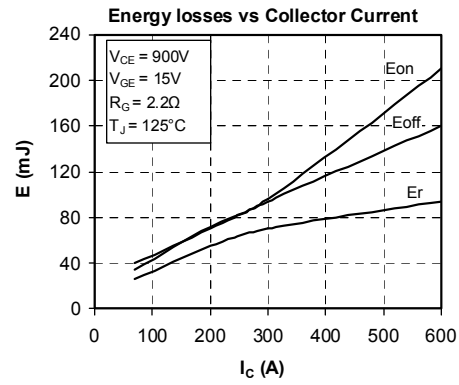
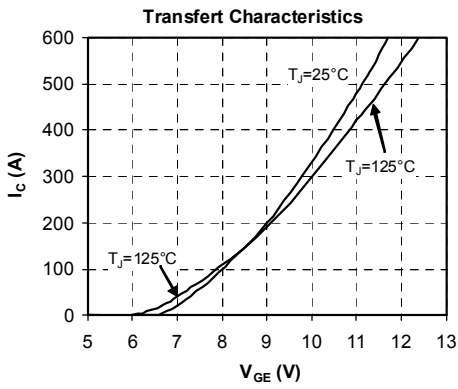
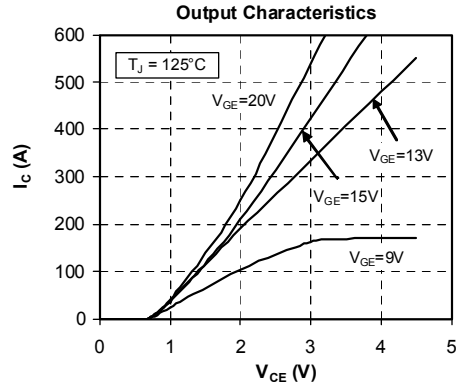
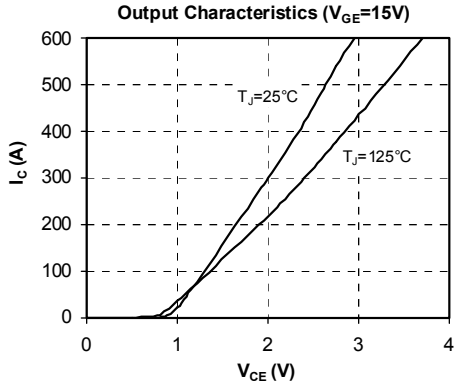

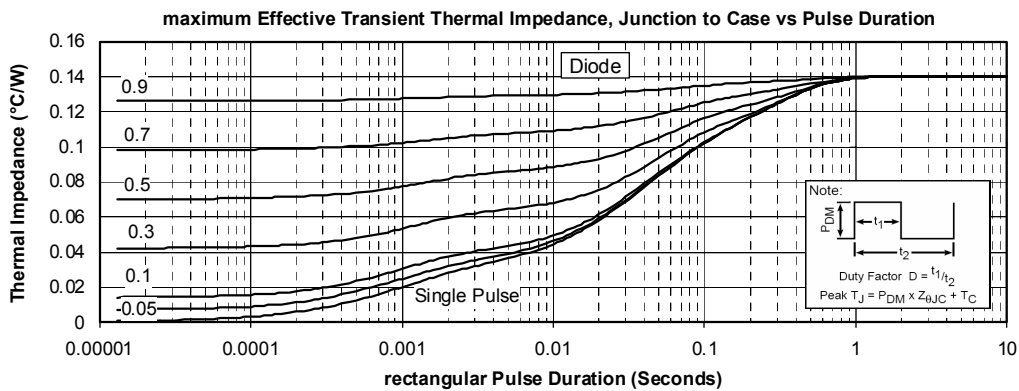
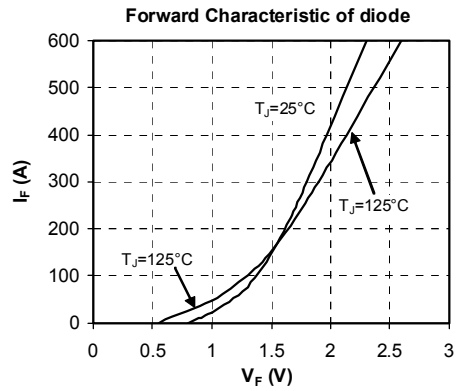
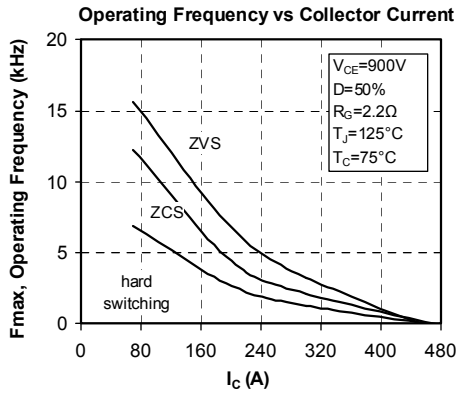

Microsemi reserves the right to change, without notice, the specifications and information contained herein

Microsemi's products are covered by one or more of U.S. patents 4,895,810 5,045,903 5,089,434 5,182,234 5,019,522 5,262,336 6,503,786 5,256,583 4,748,103 5,283,202 5,231,474 5,434,095 5,528,058 and foreign patents. U.S. and Foreign patents pending. All Rights Reserved.



Компания «ЭлектроПласт» предлагает заключение долгосрочных отношений при поставках импортных электронных компонентов на взаимовыгодных условиях!

Наши преимущества:

- Оперативные поставки широкого спектра электронных компонентов отечественного и импортного производства напрямую от производителей и с крупнейших мировых складов;
- Поставка более 17-ти миллионов наименований электронных компонентов;
- Поставка сложных, дефицитных, либо снятых с производства позиций;
- Оперативные сроки поставки под заказ (от 5 рабочих дней);
- Экспресс доставка в любую точку России;
- Техническая поддержка проекта, помощь в подборе аналогов, поставка прототипов;
- Система менеджмента качества сертифицирована по Международному стандарту ISO 9001;
- Лицензия ФСБ на осуществление работ с использованием сведений, составляющих государственную тайну;
- Поставка специализированных компонентов (Xilinx, Altera, Analog Devices, Intersil, Interpoint, Microsemi, Aeroflex, Peregrine, Syfer, Eurofarad, Texas Instrument, Miteq, Cobham, E2V, MA-COM, Hittite, Mini-Circuits, General Dynamics и др.);

Помимо этого, одним из направлений компании «ЭлектроПласт» является направление «Источники питания». Мы предлагаем Вам помощь Конструкторского отдела:

- Подбор оптимального решения, техническое обоснование при выборе компонента;
- Подбор аналогов;
- Консультации по применению компонента;
- Поставка образцов и прототипов;
- Техническая поддержка проекта;
- Защита от снятия компонента с производства.



Как с нами связаться

Телефон: 8 (812) 309 58 32 (многоканальный)

Факс: 8 (812) 320-02-42

Электронная почта: org@eplast1.ru

Адрес: 198099, г. Санкт-Петербург, ул. Калинина, дом 2, корпус 4, литера А.