



# MCP73837/8

## Advanced Stand-Alone Li-Ion / Li-Polymer Battery Charge Management Controller with Autonomous AC-Adapter or USB-Port Source Selection

### Features

- High Accuracy Preset Voltage Regulation:  $\pm 0.5\%$
- Available Voltage Regulation Options:
  - 4.20V, 4.35V, 4.4V, or 4.5V
- Complete Linear Charge Management Controller:
  - Autonomous Power Source Selection
  - Integrated Pass Transistors
  - Integrated Current Sense
  - Integrated Reverse Discharge Protection
- Constant Current (CC) / Constant Voltage (CV) Operation with Thermal Regulation
- Selectable USB-Port Charge Current:
  - Low: 1 Unit Load / High: 5 Unit Loads
- Programmable AC-Adapter Charge Current:
  - 15 mA - 1000 mA
- Two Charge Status Outputs
- Power-Good Monitor: MCP73837
- Timer Enable: MCP73838
- Automatic Recharge:
  - Selectable Voltage Threshold
- Automatic End-of-Charge Control:
  - Selectable Charge Termination Current Ratio
  - Selectable Safety Timer Period
- Preconditioning of Deeply Depleted Cells - can be disabled
- Battery Cell Temperature Monitor
- UVLO (Undervoltage Lockout)
- Automatic Power-Down when Input Power is Removed
- Low-Dropout (LDO) Linear Regulator Mode
- Numerous Selectable Options Available for a Variety of Applications:
  - Refer to **Section 1.0 "Electrical Characteristics"** for Selectable Options\*
  - Refer to the **"Product Identification System"** for Standard Options
- Temperature Range: -40°C to 85°C
- Packaging:
  - 10-Lead 3 mm x 3 mm DFN
  - 10-Lead MSOP\*
  - \* Consult Factory for MSOP Package Availability.

### Applications

- Smart Phones and Personal Data Assistants (PDA)
- Portable Media Players(PMP)
- Ultra Mobile Devices(UMD)
- Digital Cameras
- MP3 Players
- Bluetooth Headsets
- Handheld Medical Devices
- AC/USB Dual Source Li-Ion Battery Chargers

### Description

The MCP73837 and MCP73838 devices are fully integrated linear Li-Ion / Li-Polymer battery chargers with autonomous power source selection. Along with its small physical size, the low number of external components required makes the MCP73837/8 ideally suitable for portable applications.

The MCP73837/8 automatically selects the USB-Port or AC-Adapter as the power source for the system. For the USB-Port powered systems, the MCP73837/8 specifically adheres to the current limits governed by the USB specification. The host microcontroller can select from two preset maximum charge current rates of 100 mA (low power USB-port) or 500 mA (high power USB-port). With an AC-Adapter providing power to the system, an external resistor sets the magnitude of the system or charge current up to a maximum of 1A.

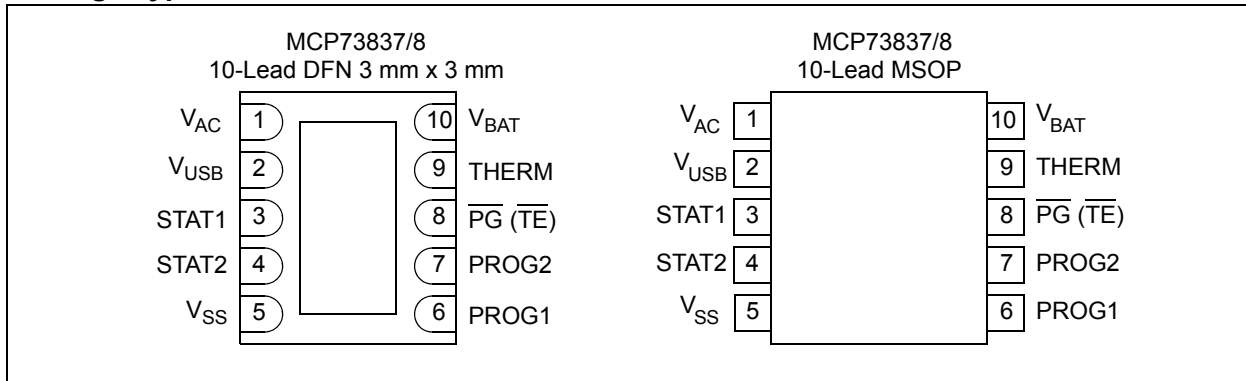
The MCP73837/8 employs a constant current / constant voltage charge algorithm with selectable preconditioning and charge termination. The constant voltage regulation is fixed with four available options: 4.20V, 4.35V, 4.40V, or 4.50V, to accommodate the new emerging battery charging requirements. The MCP73837/8 limits the charge current based on die temperature during high power or high ambient conditions. This thermal regulation optimizes the charge cycle time while maintaining the device reliability.

The MCP73837/8 are fully specified over the ambient temperature range of -40°C to +85°C.

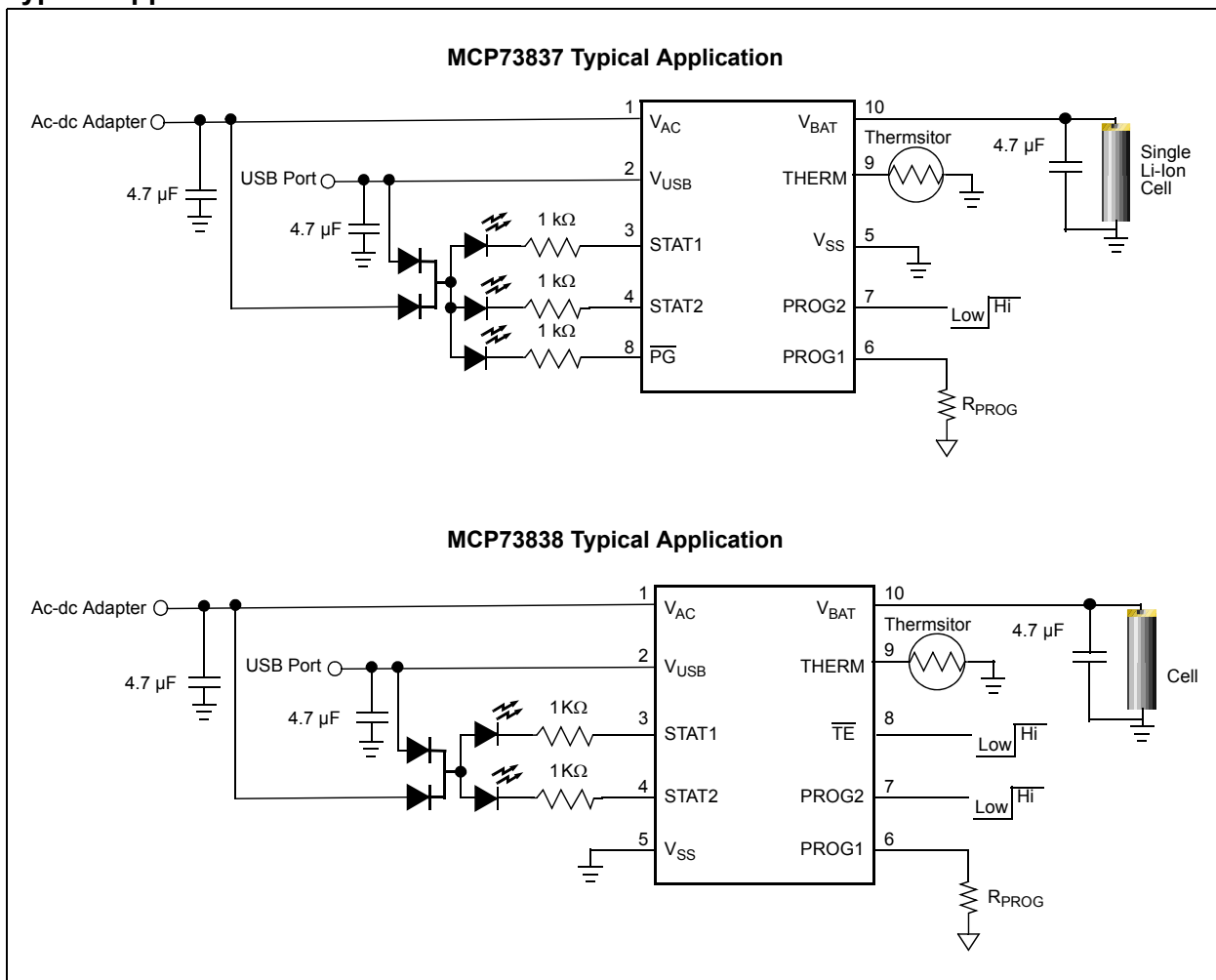
The MCP73837/8 devices are available in a 10-Lead, 3 mm x 3 mm, DFN package or in a 10-Lead MSOP package.

# MCP73837/8

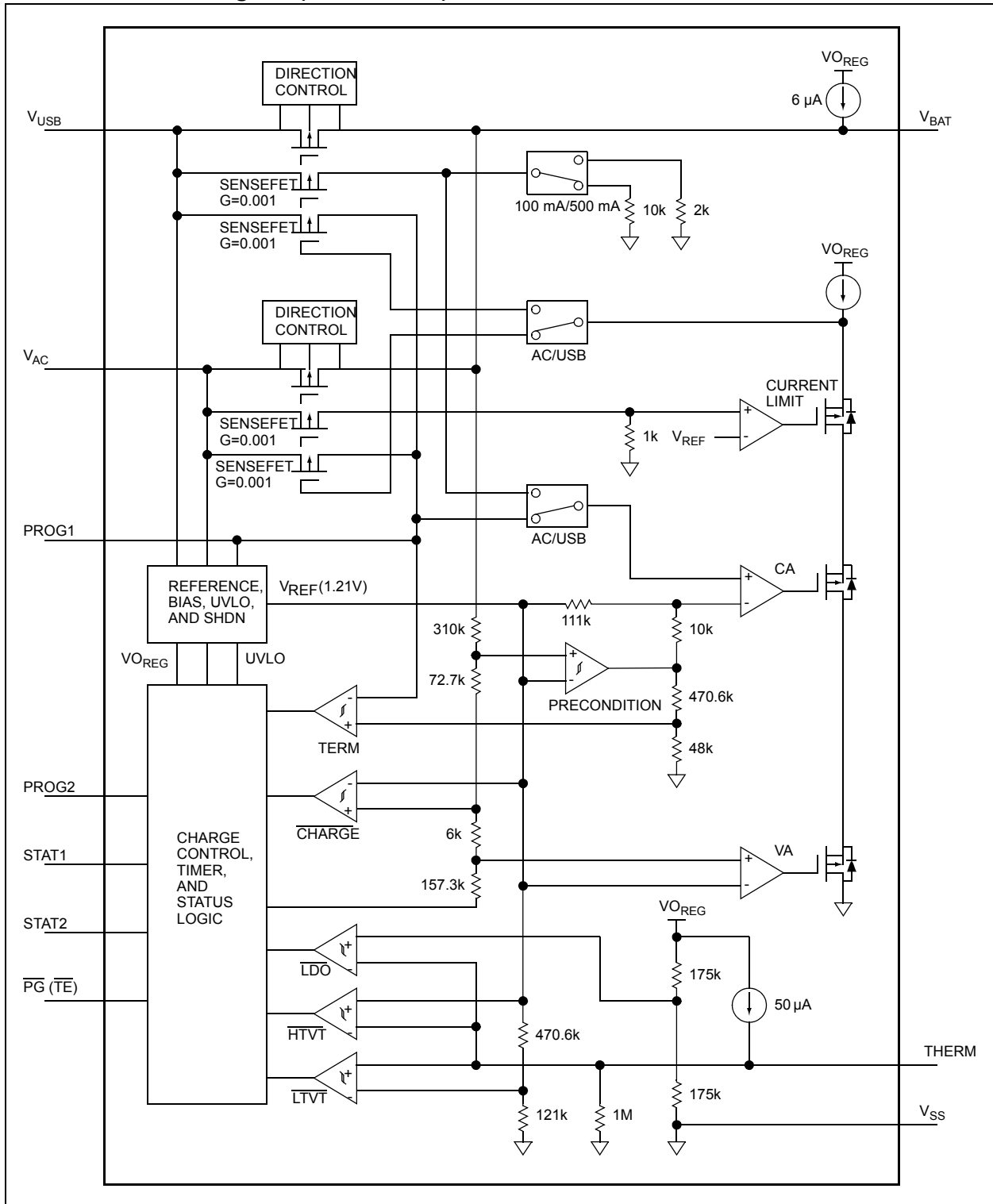
## Package Types



## Typical Applications



## Functional Block Diagram (MCP73837/8)



# MCP73837/8

## 1.0 ELECTRICAL CHARACTERISTICS

### Absolute Maximum Ratings†

$V_{DDN}$  ..... 7.0V  
 All Inputs and Outputs w.r.t.  $V_{SS}$  ..... -0.3 to ( $V_{DD}+0.3$ )V  
 Maximum Junction Temperature,  $T_J$  ..... Internally Limited  
 Storage temperature ..... -65°C to +150°C  
 ESD protection on all pins  
 Human Body Model (1.5 kW in Series with 100 pF) .....  $\geq 4$  kV  
 Machine Model (200 pF, No Series Resistance) ..... 300V

† **Notice:** Stresses above those listed under “Maximum Ratings” may cause permanent damage to the device. This is a stress rating only and functional operation of the device at those or any other conditions above those indicated in the operational listings of this specification is not implied. Exposure to maximum rating conditions for extended periods may affect device reliability.

### DC CHARACTERISTICS

| Electrical Specifications: Unless otherwise indicated, all limits apply for $V_{DD} = [V_{REG}(\text{typical}) + 0.3V]$ to 6V, $T_A = -40^\circ\text{C}$ to $+85^\circ\text{C}$ . Typical values are at $+25^\circ\text{C}$ , $V_{DD} = [V_{REG}(\text{typical}) + 1.0V]$ |   |                              |       |       |               |  |   |
|---|---|------------------------------|-------|-------|---------------|--|---|
| Parameters  | Sym   | Min                          | Typ   | Max   | Units         | Conditions   |   |
| <b>Supply Input</b>   |   |                              |       |       |               |  |   |
| Supply Voltage  | $V_{DD}$  | $V_{REG}(\text{Typ}) + 0.3V$ | —     | 6     | V             | Note 1   |   |
| Supply Current  | $I_{SS}$  | —                            | 1900  | 3000  | $\mu\text{A}$ | Charging   |   |
|   |   | —                            | 110   | 300   | $\mu\text{A}$ | Charge Complete, No Battery  |   |
|   |   | —                            | 75    | 100   | $\mu\text{A}$ | Standby (PROG Floating)  |   |
|   |   | —                            | 0.6   | 5     | $\mu\text{A}$ | Shutdown ( $V_{DD} \leq V_{BAT} - 100\text{ mV}$ or $V_{DD} < V_{STOP}$ )  |   |
| UVLO Start Threshold  | $V_{START}$   | 3.35                         | 3.45  | 3.55  | V             | $V_{DD} = \text{Low to High (USB-Port)}$   |   |
| UVLO Stop Threshold   | $V_{STOP}$  | 3.25                         | 3.35  | 3.45  | V             | $V_{DD} = \text{High to Low (USB-Port)}$   |   |
| UVLO Hysteresis   | $V_{HYS}$   | —                            | 75    | —     | mV            | (USB-Port)   |   |
| UVLO Start Threshold  | $V_{START}$   | 4.1                          | 4.15  | 4.3   | V             | (AC-Adapter)   |   |
| UVLO Stop Threshold   | $V_{STOP}$  | 4.0                          | 4.1   | 4.2   | V             | (AC-Adapter)   |   |
| UVLO Hysteresis   | $V_{HYS}$   | —                            | 55    | —     | mV            | (AC-Adapter)   |   |
| <b>Voltage Regulation (Constant Voltage Mode)</b>   |   |                              |       |       |               |  |   |
| Regulated Charge Voltage  | $V_{REG}$   | 4.179                        | 4.20  | 4.221 | V             | $V_{DD} = [V_{REG}(\text{typical}) + 1V]$<br>$I_{OUT} = 30\text{ mA}$<br>$T_A = -5^\circ\text{C}$ to $+55^\circ\text{C}$ |   |
|   |   | 4.328                        | 4.35  | 4.372 | V             |  |   |
|   |   | 4.378                        | 4.40  | 4.422 | V             |  |   |
|   |   | 4.477                        | 4.50  | 4.523 | V             |  |   |
| Regulated Charge Voltage Tolerance  | $V_{RTOL}$  | -0.5                         | —     | +0.5  | %             | $T_A = -5^\circ\text{C}$ to $+55^\circ\text{C}$  |   |
| Line Regulation   | $ \frac{\Delta V_{BAT}}{V_{BAT}} / \frac{\Delta V_{DD}}{V_{DD}} $ | —                            | 0.075 | 0.2   | %/V           | $V_{DD} = [V_{REG}(\text{typical}) + 1V]$ to 6V<br>$I_{OUT} = 30\text{ mA}$  |   |
| Load Regulation   | $ \frac{\Delta V_{BAT}}{V_{BAT}} $                                | —                            | 0.150 | 0.3   | %             | $I_{OUT} = 10\text{ mA}$ to $100\text{ mA}$<br>$V_{DD} = [V_{REG}(\text{typical}) + 1V]$                                 |   |
| Supply Ripple Attenuation   | PSRR  | —                            | 60    | —     | dB            | $I_{OUT} = 10\text{ mA}$ , 10Hz to 1 kHz   |   |
|   |   | —                            | 52    | —     | dB            |  | $I_{OUT} = 10\text{ mA}$ , 10Hz to 10 kHz |
|   |   | —                            | 23    | —     | dB            |  | $I_{OUT} = 10\text{ mA}$ , 10Hz to 1 MHz  |
| <b>Current Regulation (Fast Charge Constant-Current Mode)</b>   |   |                              |       |       |               |  |   |
| AC-Adapter Fast Charge Current  | $I_{REG}$   | 95                           | 105   | 115   | mA            | PROG1 = 10 k $\Omega$<br>PROG1 = 1 k $\Omega$ , <b>Note 2</b><br>$T_A = -5^\circ\text{C}$ to $+55^\circ\text{C}$         |   |
|   |   | 900                          | 1000  | 1100  | mA            |  |   |

- Note 1:** The supply voltage ( $V_{DD}$ ) =  $V_{AC}$  when input power source is from Ac-Adapter and the supply voltage ( $V_{DD}$ ) =  $V_{USB}$  when input power source is from USB-Port.  
**Note 2:** The value is guaranteed by design and not production tested.  
**Note 3:** The current is based on the ratio of selected current regulation ( $I_{REG}$ ).  
**Note 4:** The maximum charge impedance has to be less than shutdown impedance for normal operation.

## DC CHARACTERISTICS (Continued)

| <b>Electrical Specifications:</b> Unless otherwise indicated, all limits apply for $V_{DD} = [V_{REG}(\text{typical}) + 0.3V]$ to 6V, $T_A = -40^\circ\text{C}$ to $+85^\circ\text{C}$ . Typical values are at $+25^\circ\text{C}$ , $V_{DD} = [V_{REG}(\text{typical}) + 1.0V]$ |                      |             |      |             |               |   |
|--|----------------------|-------------|------|-------------|---------------|---|
| Parameters   | Sym                  | Min         | Typ  | Max         | Units         | Conditions  |
| USB-Port Fast Charge Current   | $I_{REG}$            | 80          | 90   | 100         | mA            | PROG2 = Low   |
|  |                      | 400         | 450  | 500         | mA            | PROG2 = High<br>$T_A = -5^\circ\text{C}$ to $+55^\circ\text{C}$   |
| Maximum Output Current Limit   | $I_{MAX}$            | —           | 1200 | —           | mA            | PROG1 < 833 $\Omega$  |
| <b>Precondition Current Regulation (Trickle Charge Constant-Current Mode)</b>  |                      |             |      |             |               |   |
| Precondition Current Ratio   | $I_{PREG} / I_{REG}$ | 7.5         | 10   | 12.5        | %             | <b>Note 3</b><br>$T_A = -5^\circ\text{C}$ to $+55^\circ\text{C}$  |
|  |                      | 15          | 20   | 25          | %             |   |
|  |                      | 30          | 40   | 50          | %             |   |
|  |                      |             | 100  |             | %             |   |
| Precondition Current Threshold Ratio   | $V_{PTH} / V_{REG}$  | 64          | 66.5 | 69          | %             | $V_{BAT}$ Low to High   |
|  |                      | 69          | 71.5 | 74          | %             |   |
| Precondition Hysteresis  | $V_{PHYS}$           | —           | 120  | —           | mV            | $V_{BAT}$ High to Low   |
| <b>Charge Termination</b>  |                      |             |      |             |               |   |
| Charge Termination Current Ratio   | $I_{TERM} / I_{REG}$ | 3.75        | 5    | 6.25        | %             | PROG1 = 1 k $\Omega$ to 10 k $\Omega$<br>$T_A = -5^\circ\text{C}$ to $+55^\circ\text{C}$<br><b>Note 3</b>                         |
|  |                      | 5.6         | 7.5  | 9.4         | %             |   |
|  |                      | 7.5         | 10   | 12.5        | %             |   |
|  |                      | 15          | 20   | 25          | %             |   |
| <b>Automatic Recharge</b>  |                      |             |      |             |               |   |
| Recharge Voltage Threshold Ratio   | $V_{RTH} / V_{REG}$  | 92          | 94.0 | 96          | %             | $V_{BAT}$ High to Low<br>$T_A = -5^\circ\text{C}$ to $+55^\circ\text{C}$  |
|  |                      | 95          | 97   | 99          | %             |   |
| <b>Pass Transistor ON-Resistance</b>   |                      |             |      |             |               |   |
| ON-Resistance  | $R_{DSON}$           | —           | 350  | —           | m $\Omega$    | $V_{DD} = 4.5V$ , $T_J = 105^\circ\text{C}$   |
| <b>Battery Discharge Current</b>   |                      |             |      |             |               |   |
| Output Reverse Leakage Current   | $I_{DISCHARGE}$      | —           | 0.1  | 2           | $\mu\text{A}$ | Standby (PROG1 or PROG2 Floating)<br>Shutdown ( $V_{DD} \leq V_{BAT} - 100\text{ mV}$ or $V_{DD} < V_{STOP}$ )<br>Charge Complete |
|  |                      | —           | 0.55 | 2           | $\mu\text{A}$ |   |
|  |                      | —           | -6   | -15         | $\mu\text{A}$ |   |
| <b>Status Indicators - STAT1, STAT2, PG (MCP73837)</b>   |                      |             |      |             |               |   |
| Sink Current   | $I_{SINK}$           | —           | 16   | 35          | mA            |   |
| Low Output Voltage   | $V_{OL}$             | —           | 0.3  | 1           | V             | $I_{SINK} = 4\text{ mA}$  |
| Input Leakage Current  | $I_{LK}$             | —           | 0.03 | 1           | $\mu\text{A}$ | High Impedance, $V_{DD}$ on pin   |
| <b>PROG1 Input (PROG1)</b>   |                      |             |      |             |               |   |
| Charge Impedance Range   | $R_{PROG}$           | 1           | —    | —           | k $\Omega$    | <b>Note 4</b>   |
| Shutdown Impedance   | $R_{PROG}$           | 70          | —    | 200         | k $\Omega$    | Minimum Impedance for Shutdown  |
| <b>PROG2 Inputs (PROG2)</b>  |                      |             |      |             |               |   |
| Input High Voltage Level   | $V_{IH}$             | $0.8V_{DD}$ | —    | —           | %             | $V_{PROG2} = V_{DD}$  |
| Input Low Voltage Level  | $V_{IL}$             | —           | —    | $0.2V_{DD}$ | %             |   |
| Shutdown Voltage Level   | $V_{SD}$             | $0.2V_{DD}$ | —    | $0.8V_{DD}$ | %             |   |
| Input Leakage Current  | $I_{LK}$             | —           | 7    | 15          | $\mu\text{A}$ |   |

- Note 1:** The supply voltage ( $V_{DD}$ ) =  $V_{AC}$  when input power source is from Ac-Adapter and the supply voltage ( $V_{DD}$ ) =  $V_{USB}$  when input power source is from USB-Port.
- Note 2:** The value is guaranteed by design and not production tested.
- Note 3:** The current is based on the ratio of selected current regulation ( $I_{REG}$ ).
- Note 4:** The maximum charge impedance has to be less than shutdown impedance for normal operation.

# MCP73837/8

## DC CHARACTERISTICS (Continued)

| <b>Electrical Specifications:</b> Unless otherwise indicated, all limits apply for $V_{DD} = [V_{REG}(\text{typical}) + 0.3V]$ to 6V, $T_A = -40^\circ\text{C}$ to $+85^\circ\text{C}$ . Typical values are at $+25^\circ\text{C}$ , $V_{DD} = [V_{REG}(\text{typical}) + 1.0V]$ |              |                          |                           |                           |                                |  |
|--|--------------|--------------------------|---------------------------|---------------------------|--------------------------------|--|
| Parameters   | Sym          | Min                      | Typ                       | Max                       | Units                          | Conditions   |
| <b>Timer Enable (TE)</b>   |              |                          |                           |                           |                                |  |
| Input High Voltage Level   | $V_{IH}$     | 2                        | —                         | —                         | V                              |  |
| Input Low Voltage Level  | $V_{IL}$     | —                        | —                         | 0.8                       | V                              |  |
| Input Leakage Current  | $I_{LK}$     | —                        | 0.01                      | 1                         | $\mu\text{A}$                  | $V_{TE} = V_{DD}$                                      |
| <b>Thermistor Bias</b>   |              |                          |                           |                           |                                |  |
| Thermistor Current Source  | $I_{THERM}$  | 47                       | 50                        | 53                        | $\mu\text{A}$                  | $2\text{ k}\Omega < R_{THERM} < 50\text{ k}\Omega$     |
| <b>Thermistor Comparator</b>   |              |                          |                           |                           |                                |  |
| Upper Trip Threshold   | $V_{T1}$     | 1.20                     | 1.23                      | 1.26                      | V                              | $V_{T1}$ Low to High                                   |
| Upper Trip Point Hysteresis  | $V_{T1HYS}$  | —                        | -40                       | —                         | mV                             |  |
| Lower Trip Threshold   | $V_{T2}$     | 0.235                    | 0.250                     | 0.265                     | V                              | $V_{T2}$ High to Low                                   |
| Lower Trip Point Hysteresis  | $V_{T2HYS}$  | —                        | 40                        | —                         | mV                             |  |
| <b>System Test (LDO) Mode</b>  |              |                          |                           |                           |                                |  |
| Input High Voltage Level   | $V_{IH}$     | —                        | —                         | $V_{DD} - 0.1$            | V                              |  |
| THERM Input Sink Current   | $I_{SINK}$   | 3                        | 5.5                       | 20                        | $\mu\text{A}$                  | Stand-by Or System Test Mode                           |
| Bypass Capacitance   | $C_{BAT}$    | 1<br>4.7                 | —                         | —                         | $\mu\text{F}$<br>$\mu\text{F}$ | $I_{OUT} < 250\text{ mA}$<br>$I_{OUT} > 250\text{ mA}$ |
| <b>Automatic Power Down (SLEEP Comparator, Direction Control)</b>  |              |                          |                           |                           |                                |  |
| Automatic Power Down Entry Threshold   | $V_{PD}$     | $V_{BAT} + 10\text{ mV}$ | $V_{BAT} + 100\text{ mV}$ | —                         | V                              | $2.3V \leq V_{BAT} \leq V_{REG}$<br>$V_{DD}$ Falling   |
| Automatic Power Down Exit Threshold  | $V_{PDEXIT}$ | -                        | $V_{BAT} + 150\text{ mV}$ | $V_{BAT} + 250\text{ mV}$ | V                              | $2.3V \leq V_{BAT} \leq V_{REG}$<br>$V_{DD}$ Rising    |
| <b>Thermal Shutdown</b>  |              |                          |                           |                           |                                |  |
| Die Temperature  | $T_{SD}$     | —                        | 150                       | —                         | $^\circ\text{C}$               |  |
| Die Temperature Hysteresis   | $T_{SDHYS}$  | —                        | 10                        | —                         | $^\circ\text{C}$               |  |

- Note** 1: The supply voltage ( $V_{DD}$ ) =  $V_{AC}$  when input power source is from Ac-Adapter and the supply voltage ( $V_{DD}$ ) =  $V_{USB}$  when input power source is from USB-Port.
- 2: The value is guaranteed by design and not production tested.
- 3: The current is based on the ratio of selected current regulation ( $I_{REG}$ ).
- 4: The maximum charge impedance has to be less than shutdown impedance for normal operation.

## AC CHARACTERISTICS

| <b>Electrical Specifications:</b> Unless otherwise indicated, all limits apply for $V_{DD} = [V_{REG} \text{ (typical)} + 0.3V]$ to 6V.<br>Typical values are at +25°C, $V_{DD} = [V_{REG} \text{ (typical)} + 1.0V]$ |               |     |     |     |         |  |
|---|---------------|-----|-----|-----|---------|--|
| Parameters  | Sym           | Min | Typ | Max | Units   | Conditions                                 |
| UVLO Start Delay  | $t_{START}$   | —   | —   | 5   | ms      | $V_{DD}$ Low to High                       |
| <b>Current Regulation</b>   |               |     |     |     |         |  |
| Transition Time Out of Precondition   | $t_{DELAY}$   | —   | —   | 10  | ms      | $V_{BAT} < V_{PTH}$ to $V_{BAT} > V_{PTH}$ |
| Current Rise Time Out of Precondition   | $t_{RISE}$    | —   | —   | 10  | ms      | $I_{OUT}$ Rising to 90% of $I_{REG}$       |
| Precondition Comparator Filter Time   | $t_{PRECON}$  | 0.4 | 1.3 | 3.2 | ms      | Average $V_{BAT}$ Rise/Fall                |
| Termination Comparator Filter Time  | $t_{TERM}$    | 0.4 | 1.3 | 3.2 | ms      | Average $I_{OUT}$ Falling                  |
| Charge Comparator Filter Time   | $t_{CHARGE}$  | 0.4 | 1.3 | 3.2 | ms      | Average $V_{BAT}$ Falling                  |
| Thermistor Comparator Filter Time   | $t_{THERM}$   | 0.4 | 1.3 | 3.2 | ms      | Average THERM Rise/Fall                    |
| <b>Elapsed Timer</b>  |               |     |     |     |         |  |
| Elapsed Timer Period  | $t_{ELAPSED}$ | 0   | 0   | 0   | Hours   | Timer Disabled                             |
|   |               | 3.6 | 4.0 | 4.4 | Hours   |  |
|   |               | 5.4 | 6.0 | 6.6 | Hours   |  |
|   |               | 7.2 | 8.0 | 8.8 | Hours   |  |
| <b>Status Indicators</b>  |               |     |     |     |         |  |
| Status Output Turn-off  | $t_{OFF}$     | —   | —   | 500 | $\mu s$ | $I_{SINK} = 1 \text{ mA to } 0 \text{ mA}$ |
| Status Output Turn-on   | $t_{ON}$      | —   | —   | 500 | $\mu s$ | $I_{SINK} = 0 \text{ mA to } 1 \text{ mA}$ |

## TEMPERATURE SPECIFICATIONS

| <b>Electrical Specifications:</b> Unless otherwise indicated, all limits apply for $V_{DD} = [V_{REG} \text{ (typ.)} + 0.3V]$ to 6V.<br>Typical values are at +25°C, $V_{DD} = [V_{REG} \text{ (typ.)} + 1.0V]$ |               |     |     |      |       |  |
|---|---------------|-----|-----|------|-------|--|
| Parameters  | Sym           | Min | Typ | Max  | Units | Conditions   |
| <b>Temperature Ranges</b>   |               |     |     |      |       |  |
| Specified Temperature Range   | $T_A$         | -40 | —   | +85  | °C    |  |
| Operating Temperature Range   | $T_J$         | -40 | —   | +125 | °C    |  |
| Storage Temperature Range   | $T_A$         | -65 | —   | +150 | °C    |  |
| <b>Thermal Package Resistances</b>  |               |     |     |      |       |  |
| Thermal Resistance, 10-Lead MSOP  | $\theta_{JA}$ | —   | 113 | —    | °C/W  | 4-Layer JC51-7 Standard Board, Natural Convection. <b>Note 1</b> |
| Thermal Resistance, 10-Lead 3 mm x 3 mm DFN   | $\theta_{JA}$ | —   | 41  | —    | °C/W  | 4-Layer JC51-7 Standard Board, Natural Convection                |

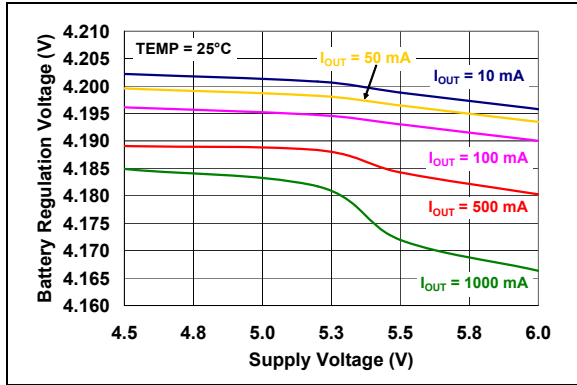
**Note 1:** This represents the minimum copper condition on the PCB ( Printed Circuit Board).

# MCP73837/8

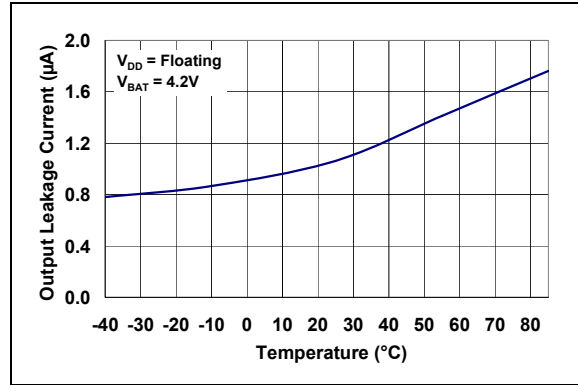
## 2.0 TYPICAL PERFORMANCE CURVES

**Note:** The graphs and tables provided following this note are a statistical summary based on a limited number of samples and are provided for informational purposes only. The performance characteristics listed herein are not tested or guaranteed. In some graphs or tables, the data presented may be outside the specified operating range (e.g., outside specified power supply range) and therefore outside the warranted range.

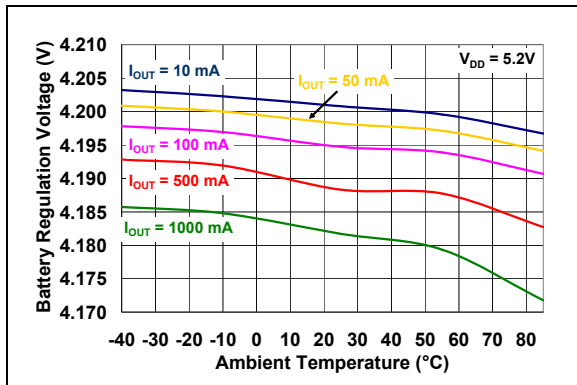
**Note:** Unless otherwise indicated,  $V_{DD} = [V_{REG}(\text{typical}) + 1V]$ ,  $I_{OUT} = 30 \text{ mA}$ , and  $T_A = +25^\circ\text{C}$ , Constant-voltage mode.



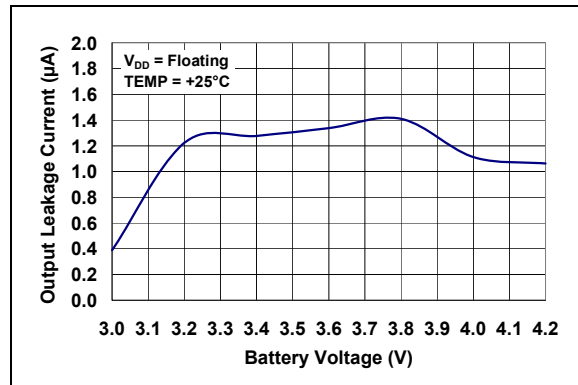
**FIGURE 2-1:** Battery Regulation Voltage ( $V_{BAT}$ ) vs. Supply Voltage ( $V_{DD}$ ).



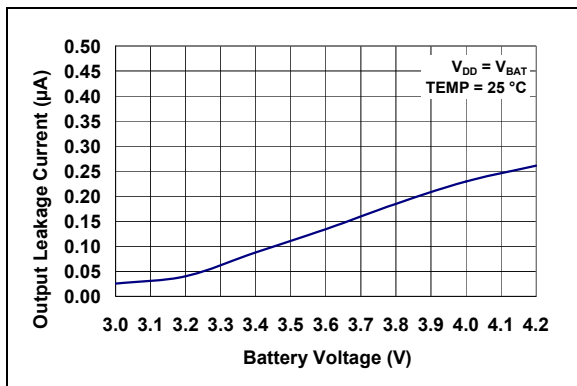
**FIGURE 2-4:** Output Leakage Current ( $I_{DISCHARGE}$ ) vs. Ambient Temperature ( $T_A$ ).



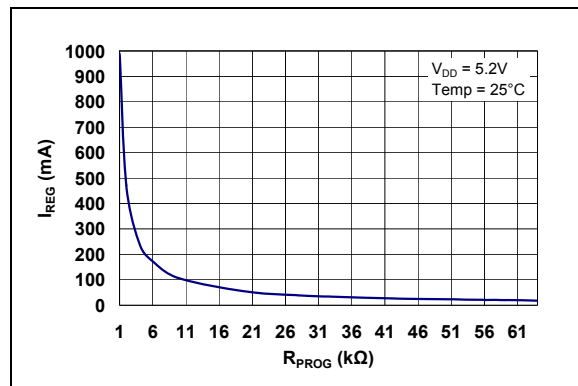
**FIGURE 2-2:** Battery Regulation Voltage ( $V_{BAT}$ ) vs. Ambient Temperature ( $T_A$ ).



**FIGURE 2-5:** Output Leakage Current ( $I_{DISCHARGE}$ ) vs. Battery Voltage ( $V_{BAT}$ ).



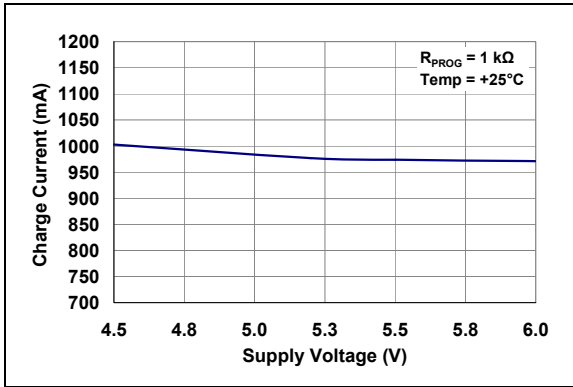
**FIGURE 2-3:** Output Leakage Current ( $I_{DISCHARGE}$ ) vs. Battery Regulation Voltage ( $V_{BAT}$ ).



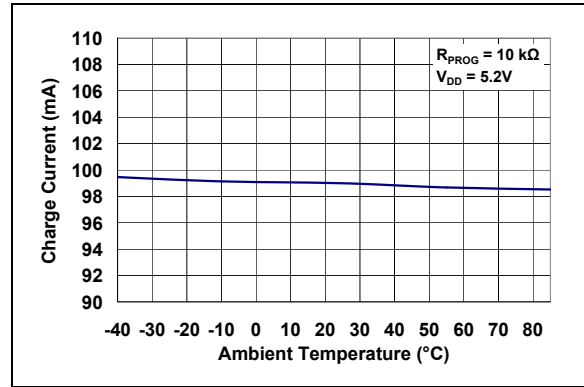
**FIGURE 2-6:** Charge Current ( $I_{OUT}$ ) vs. Programming Resistor ( $R_{PROG}$ ).



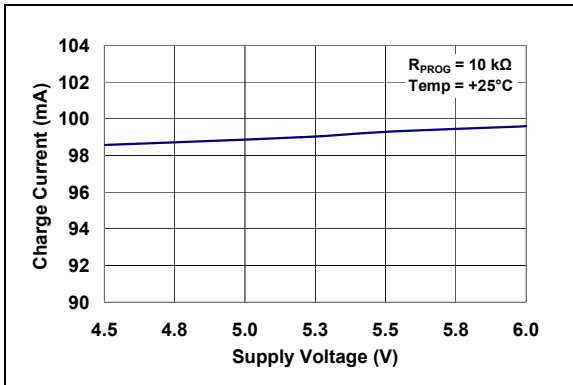
**Note:** Unless otherwise indicated,  $V_{DD} = [V_{REG}(\text{typical}) + 1V]$ ,  $I_{OUT} = 30 \text{ mA}$  and  $T_A = +25^\circ\text{C}$ , Constant-voltage mode.



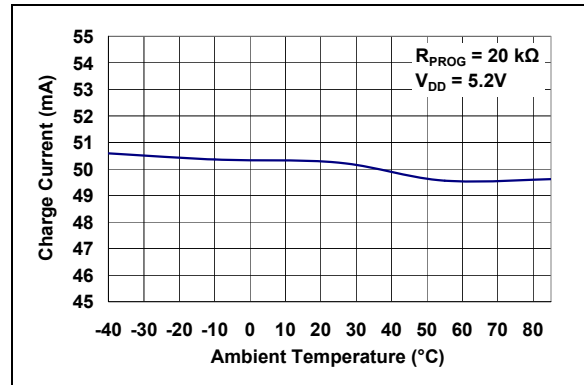
**FIGURE 2-7:** Charge Current ( $I_{OUT}$ ) vs. Supply Voltage ( $V_{DD}$ ).



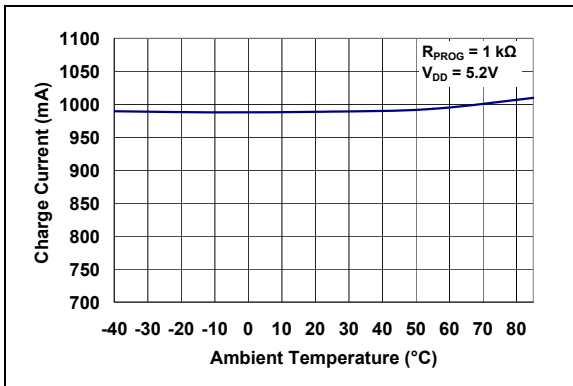
**FIGURE 2-10:** Charge Current ( $I_{OUT}$ ) vs. Ambient Temperature ( $T_A$ ).



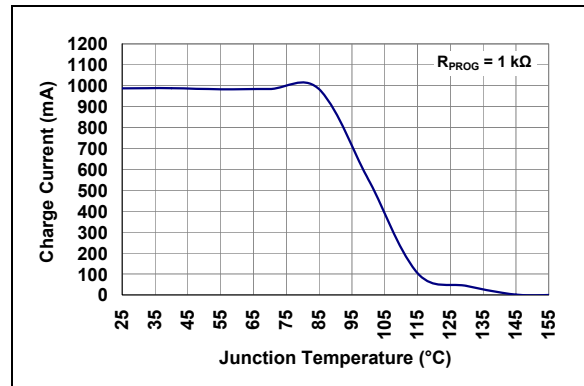
**FIGURE 2-8:** Charge Current ( $I_{OUT}$ ) vs. Supply Voltage ( $V_{DD}$ ).



**FIGURE 2-11:** Charge Current ( $I_{OUT}$ ) vs. Ambient Temperature ( $T_A$ ).



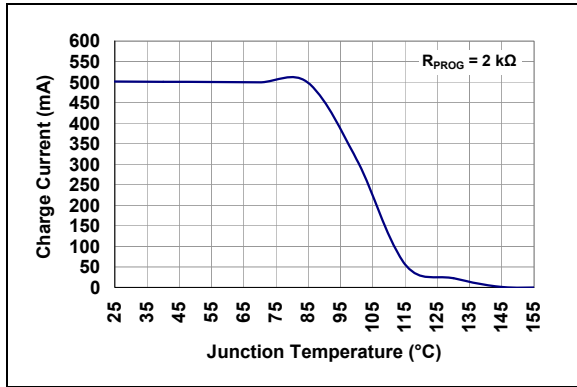
**FIGURE 2-9:** Charge Current ( $I_{OUT}$ ) vs. Ambient Temperature ( $T_A$ ).



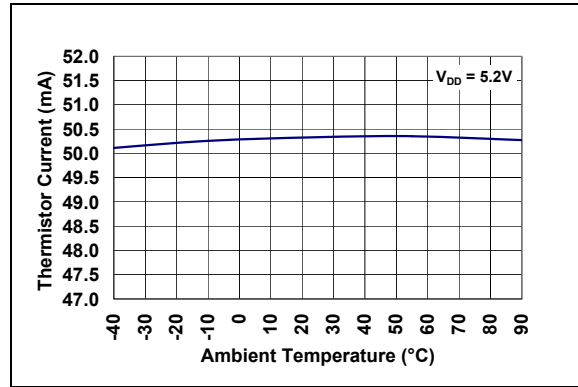
**FIGURE 2-12:** Charge Current ( $I_{OUT}$ ) vs. Junction Temperature ( $T_J$ ).

# MCP73837/8

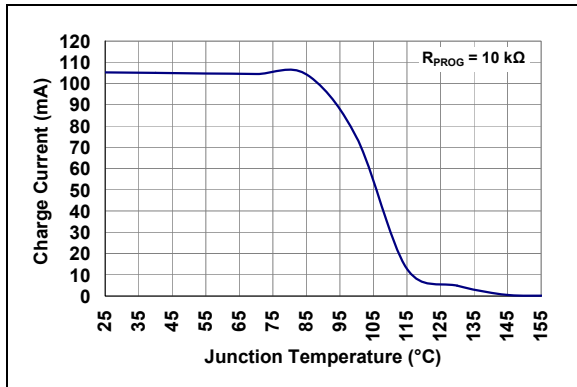
Note: Unless otherwise indicated,  $V_{DD} = [V_{REG}(\text{typical}) + 1V]$ ,  $I_{OUT} = 30 \text{ mA}$  and  $T_A = +25^\circ\text{C}$ , Constant-voltage mode.



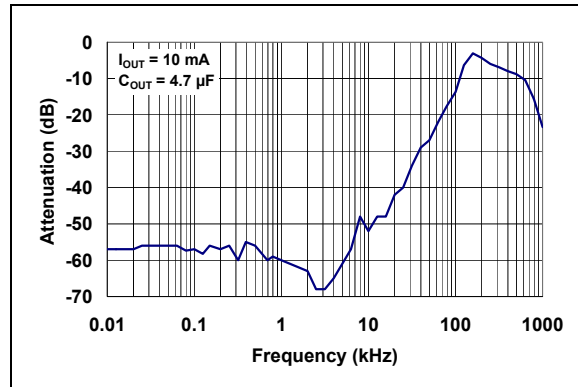
**FIGURE 2-13:** Charge Current ( $I_{OUT}$ ) vs. Junction Temperature ( $T_J$ ).



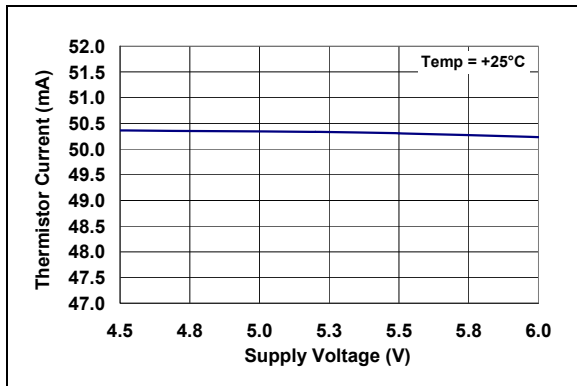
**FIGURE 2-16:** Thermistor Current ( $I_{THERM}$ ) vs. Ambient Temperature ( $T_A$ ).



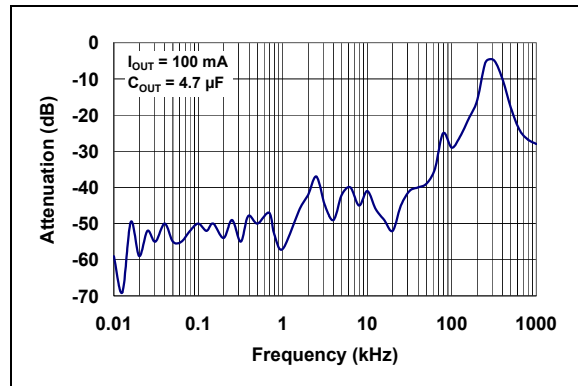
**FIGURE 2-14:** Charge Current ( $I_{OUT}$ ) vs. Junction Temperature ( $T_J$ ).



**FIGURE 2-17:** Power Supply Ripple Rejection (PSRR).

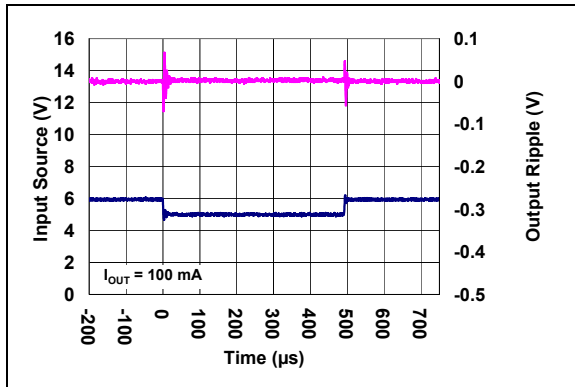


**FIGURE 2-15:** Thermistor Current ( $I_{THERM}$ ) vs. Supply Voltage ( $V_{DD}$ ).

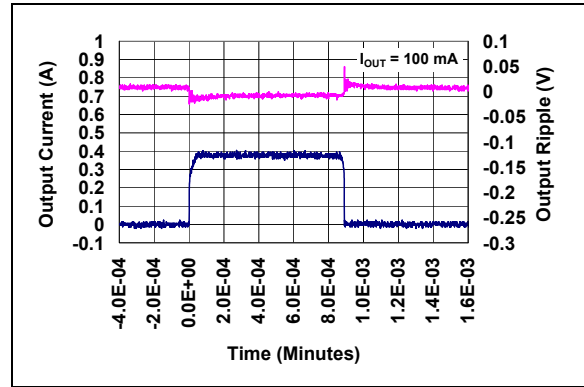


**FIGURE 2-18:** Power Supply Ripple Rejection (PSRR).

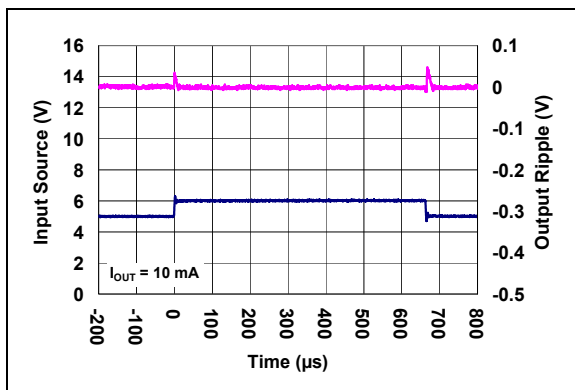
**Note:** Unless otherwise indicated,  $V_{DD} = [V_{REG}(\text{typical}) + 1V]$ ,  $I_{OUT} = 30 \text{ mA}$  and  $T_A = +25^\circ\text{C}$ , Constant-voltage mode.



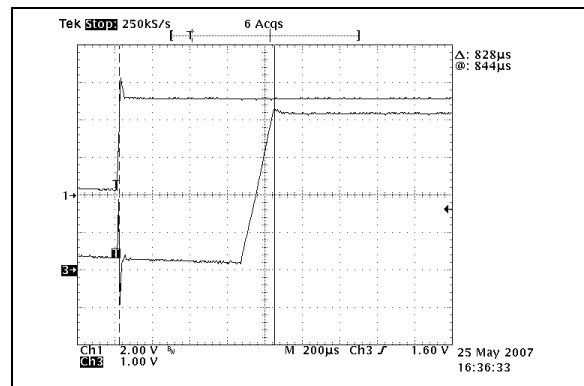
**FIGURE 2-19:** Line Transient Response.



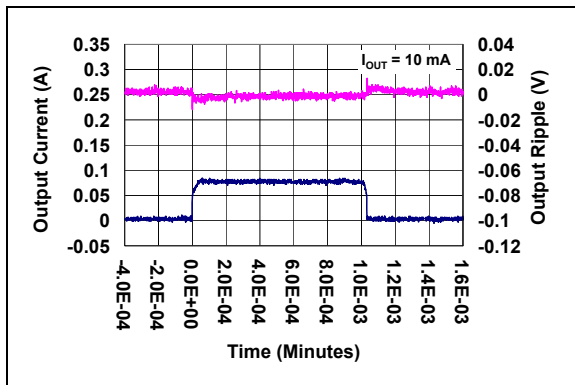
**FIGURE 2-22:** Load Transient Response.



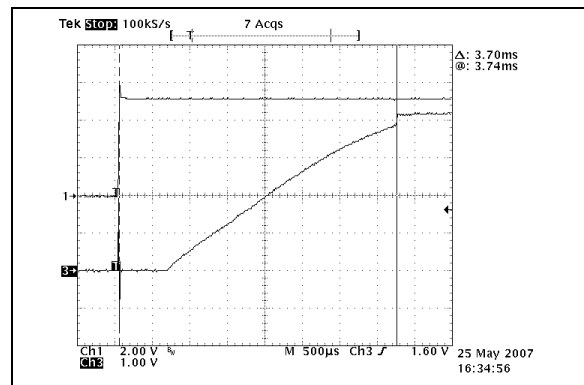
**FIGURE 2-20:** Line Transient Response.



**FIGURE 2-23:**  $V_{AC}$  UVLO Start Delay ( $I_{OUT} = 1A$ ).



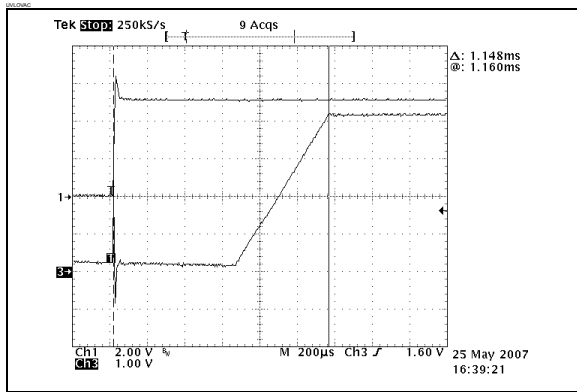
**FIGURE 2-21:** Load Transient Response.



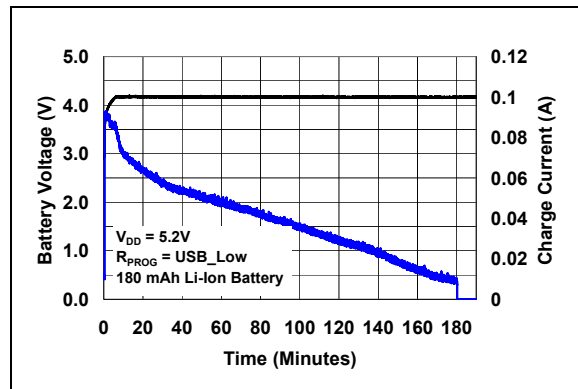
**FIGURE 2-24:**  $V_{USB}$  UVLO Start Delay (USB = Low).

# MCP73837/8

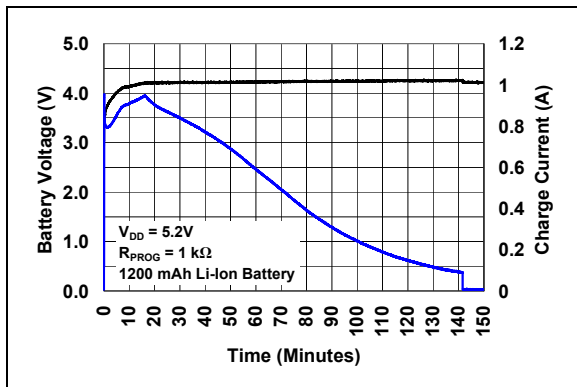
**Note:** Unless otherwise indicated,  $V_{DD} = [V_{REG}(\text{typical}) + 1V]$ ,  $I_{OUT} = 30 \text{ mA}$  and  $T_A = +25^\circ\text{C}$ , Constant-voltage mode.



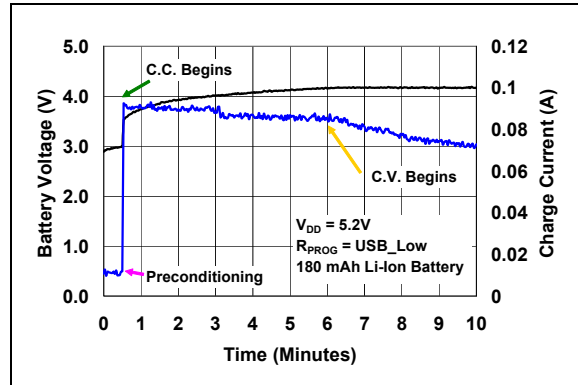
**FIGURE 2-25:**  $V_{USB}$  UVLO Start Delay (USB = High)



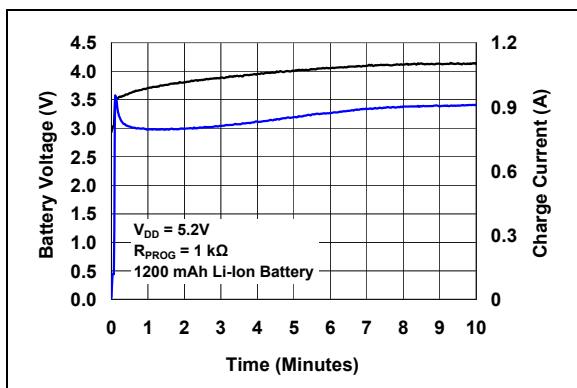
**FIGURE 2-28:** Complete Charge Cycle (180 mAh Li-Ion Battery).



**FIGURE 2-26:** Complete Charge Cycle (1200 mAh Li-Ion Battery).



**FIGURE 2-29:** Typical Charge Profile in Preconditioning and CC-CV (180 mAh Li-Ion Battery).



**FIGURE 2-27:** Typical Charge Profile in Thermal Regulation (1200 mAh Li-Ion Battery).

## 3.0 PIN DESCRIPTION

The descriptions of the pins are listed in [Table 3-1](#).

**TABLE 3-1: PIN FUNCTION TABLES**

| Pin Number |        | Symbol          | I/O | Function   |
|------------|--------|-----------------|-----|--|
| MSOP-10    | DFN-10 |                 |     |  |
| 1          | 1      | $V_{AC}$        | I   | AC-Adapter Supply Input  |
| 2          | 2      | $V_{USB}$       | I   | USB-Port Supply Input  |
| 3          | 3      | STAT1           | O   | Charge Status Output 1 (Open-Drain)  |
| 4          | 4      | STAT2           | O   | Charge Status Output 2 (Open-Drain)  |
| 5          | 5      | $V_{SS}$        | —   | Battery Management 0V Reference  |
| 6          | 6      | PROG1           | I/O | Current Regulation Setting With AC-Adapter; Device Charge Control Enable; Precondition Set Point for AC control  |
| 7          | 7      | PROG2           | I   | Current Regulation Setting With USB-Port; Precondition Set Point for USB control.  |
| 8          | 8      | $\overline{PG}$ | O   | Available on MCP73837: Power-Good Status Output (Open-Drain)   |
| 8          | 8      | $\overline{TE}$ | I   | Available on MCP73838: Timer Enable; Enables Safety Timer (Active Low)   |
| 9          | 9      | THERM           | I/O | Thermistor Monitoring Input and Bias current; System Test (LDO) Mode Input   |
| 10         | 10     | $V_{BAT}$       | I/O | Battery Positive Input and Output Connection   |
| —          | EP     | $V_{SS}$        | —   | EP (Exposed Thermal Pad); There is an internal electrical connection between the exposed thermal pad and $V_{SS}$ . The EP must be connected to the same potential as the $V_{SS}$ pin on the Printed Circuit Board (PCB). |

### 3.1 AC-Adapter Supply Input ( $V_{AC}$ )

A supply voltage of  $V_{REG} + 0.3V$  to 6V from ac-dc wall-adapter is recommended. When both the AC-Adapter and the USB-Port supply voltages are present at same time, the AC-Adapter dominates the regulated charge current with the maximum value of 1A. Bypass to  $V_{SS}$  with a minimum of 4.7  $\mu F$  is recommended.

### 3.2 USB-Port Supply Input ( $V_{USB}$ )

A supply voltage of  $V_{REG} + 0.3V$  to 6V from USB-Port is recommended. When no supply voltage from  $V_{AC}$  pin is available, the Li-Ion battery is charged directly from USB-Port. Bypass to  $V_{SS}$  with a minimum of 1  $\mu F$  is recommended.

### 3.3 Charge Status Output 1 (STAT1)

STAT1 is an open-drain logic output for connection to a LED for charge status indication. Alternatively, a pull-up resistor can be applied for interfacing to a host microcontroller.

### 3.4 Charge Status Output 2 (STAT2)

STAT2 is an open-drain logic output for connection to a LED for charge status indication. Alternatively, a pull-up resistor can be applied for interfacing to a host microcontroller.

### 3.5 Battery Management 0V Reference ( $V_{SS}$ )

Connect to negative terminal of battery and input supply.

### 3.6 Battery Charge Control Output ( $V_{BAT}$ )

Connect to the positive terminal of Li-Ion / Li-Polymer batteries. Bypass to  $V_{SS}$  with a minimum of 1  $\mu F$  to ensure loop stability when the battery is disconnected.

### 3.7 AC-Adapter Current Regulation Set (PROG1)

The AC-Adapter constant charge current is set by placing a resistor from PROG1 to  $V_{SS}$ . PROG1 is the set point of precondition and termination when the AC-Adapter is present.

PROG1 also functions as device charge control enable. The MCP73837/8 is shut down when an impedance value greater than 70 k $\Omega$  is applied to PROG1. When PROG1 is floating, the MCP73837/8 enters stand-by mode.

# MCP73837/8

---

## 3.8 USB-Port Current Regulation Set (PROG2)

The MCP73837/8 USB-Port current regulation set input (PROG2) is a digital input selection. A logic Low selects a 1 unit load charge current; a logic High selects a 5 unit loads charge current.

PROG2 also functions as the set point of precondition and termination when USB-Port is present. When PROG2 is floating, the MCP73837/8 enters in stand-by mode.

## 3.9 Power Good ( $\overline{\text{PG}}$ )

Power Good ( $\overline{\text{PG}}$ ) is available only on MCP73837.  $\overline{\text{PG}}$  is an open-drain logic output for connection to a LED for input power supply indication. Alternatively, a pull-up resistor can be applied for interfacing to a host microcontroller.

## 3.10 Timer Enable ( $\overline{\text{TE}}$ )

Timer Enable ( $\overline{\text{TE}}$ ) is available only on MCP73838. ( $\overline{\text{TE}}$ ) enables the built-in safety timer when pull low and disables the built-in safety timer when pull high.

**Note:** The built-in safety timer is available for both MCP73837 and MCP73838 in the following options: Disable, 4 HR, 6 HR, and 8 HR.

## 3.11 Battery Temperature Monitor (THERM)

MCP73837/8 continuously monitors the battery temperature during a charge cycle by measuring the voltage between the THERM and  $V_{\text{SS}}$  pins. An internal 50  $\mu\text{A}$  current source provides the bias for the most common 10 k $\Omega$  negative-temperature coefficient thermistors (NTC).

## 4.0 DEVICE OVERVIEW

The MCP73837/8 devices are simple, yet fully integrated linear charge management controllers. Figure 4-1 depicts the operational flow algorithm.

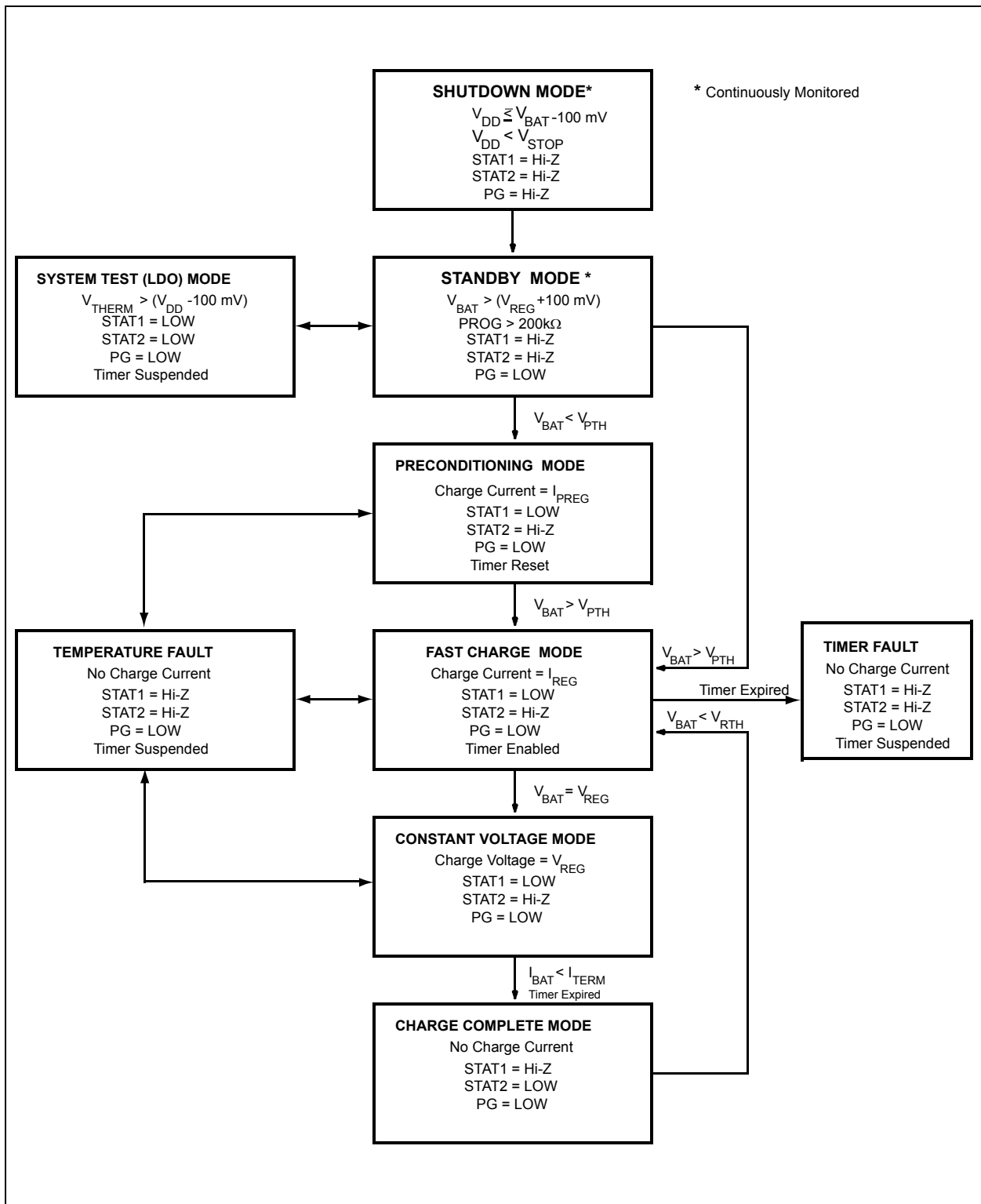


FIGURE 4-1: Flow Chart.

# MCP73837/8

## 4.1 Undervoltage Lockout (UVLO)

An internal undervoltage lockout (UVLO) circuit monitors the input voltage and keeps the charger in shutdown mode until the input supply rises above the UVLO threshold. The UVLO circuitry has a built-in hysteresis of 75 mV for the USB-Port and 55 mV for the AC-Adapter.

In the event a battery is present when the input power is applied, the input supply must rise 100 mV above the battery voltage before MCP73837/8 becomes operational.

The UVLO circuit places the device in shutdown mode if the input supply falls to within +100 mV of the battery voltage.

The UVLO circuit is always active. At any time the input supply is below the UVLO threshold or within +100 mV of the voltage at the  $V_{BAT}$  pin, the MCP73837/8 is placed in a shutdown mode.

During any UVLO condition, the battery reverse discharge current shall be less than 2  $\mu$ A.

## 4.2 AUTONOMOUS POWER SOURCE SELECTION

The MCP73837/8 devices are designed to select the USB-port or the AC-Adapter as the power source automatically. If the AC-Adapter input is not present, the USB-Port is selected. If both inputs are available, the AC-Adapter has first priority.

**Note:** If the input power is switched during a charge cycle, the power path switch-over shall be a break-before-make connection. As a result, the charge current can momentarily go to zero. The charge cycle timer shall remain continuous.

## 4.3 Charge Qualification

For a charge cycle to begin, all UVLO conditions must be met and a battery or output load must be present.

A charge current programming resistor must be connected from PROG1 to  $V_{SS}$ . If the PROG1 or PROG2 pin are open or floating, the MCP73837/8 is disabled and the battery reverse discharge current is less than 2  $\mu$ A. In this manner, the PROG1 pin acts as a charge enable and can be used as a manual shutdown.

## 4.4 Preconditioning

If the voltage at the  $V_{BAT}$  pin is less than the preconditioning threshold, the MCP73837/8 enters a preconditioning mode. The preconditioning threshold is factory set. Refer to **Section 1.0 “Electrical Characteristics”** for preconditioning threshold options.

In this mode, the MCP73837/8 supplies a percentage of the charge current (established with the value of the resistor connected to the PROG pin) to the battery. The percentage or ratio of the current is factory set. Refer to **Section 1.0 “Electrical Characteristics”** for preconditioning current options.

When the voltage at the  $V_{BAT}$  pin rises above the preconditioning threshold, the MCP73837/8 enters the constant current or fast charge mode.

## 4.5 Constant Current MODE - Fast Charge

During the constant current mode, the programmed (AC-Adapter) or selected (USB-Port) charge current is supplied to the battery or load.

For AC-Adapter, the charge current is established using a single resistor from PROG to  $V_{SS}$ . The program resistor and the charge current are calculated using the following equation:

### EQUATION 4-1:

$$I_{REG} = \frac{1000V}{R_{PROG}}$$

where  $R_{PROG}$  is in kilo-ohms ( $k\Omega$ ) and  $I_{REG}$  is in milliamperes (mA).

When charging from a USB-Port, the host microcontroller has the option of selecting either a one unit load or a five unit loads charge rate based on the PROG2 input. A logic LOW selects a one unit load charge rate, a HIGH selects a five unit loads charge rate, and high impedance input suspends or disables charging.

**Note:** USB Specification Rev. 2.0 defines the maximum absolute current for one unit load is 100 mA. This value is not an average over time and shall not be exceed.

Constant current mode is maintained until the voltage at the  $V_{BAT}$  pin reaches the regulation voltage,  $V_{REG}$ , when constant current mode is invoked, the internal timer is reset.

### 4.5.1 TIMER EXPIRED DURING CONSTANT CURRENT - FAST CHARGE MODE

If the internal timer expires before the recharge voltage threshold is reached, a timer fault is indicated and the charge cycle terminates. The MCP73837/8 remains in this condition until the battery is removed, the input battery is removed or the PROG1/2 pin is opened. If the battery is removed or the PROG1/2 pin is opened, the MCP73837/8 enters the Stand-by mode where it remains until a battery is reinserted or the PROG1/2 pin



is reconnected. If the input power is removed, the MCP73837/8 is in Shutdown. When the input power is reapplied, a normal start-up sequence ensues.

## 4.6 Constant Voltage Mode

When the voltage at the  $V_{BAT}$  pin reaches the regulation voltage,  $V_{REG}$ , constant voltage regulation begins. The regulation voltage is factory set to 4.20V, 4.35V, 4.40V, or 4.5V with a tolerance of  $\pm 0.5\%$ .

## 4.7 Charge Termination

The charge cycle is terminated when, during constant voltage mode, the average charge current diminishes below a percentage of the programmed charge current (established with the value of the resistor connected to the PROG pin) or the internal timer has expired. A 1 ms filter time on the termination comparator ensures that transient load conditions do not result in premature charge cycle termination. The percentage or ratio of the current is factory set. The timer period is factory set and can be disabled. Refer to **Section 1.0 “Electrical Characteristics”** for charge termination current ratio and timer period options.

The charge current is latched off and the MCP73837/8 enters a charge complete mode.

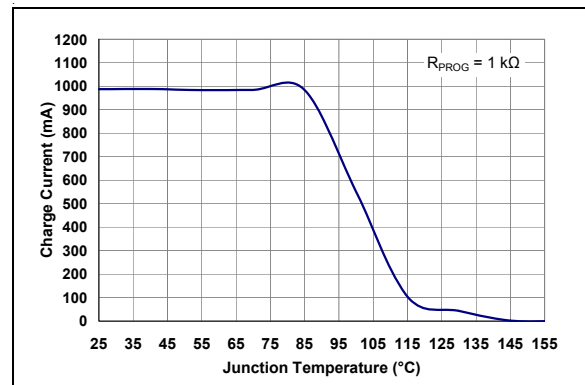
## 4.8 Automatic Recharge

The MCP73837/8 continuously monitors the voltage at the  $V_{BAT}$  pin in the charge complete mode. If the voltage drops below the recharge threshold, another charge cycle begins and current is once again supplied to the battery or load. The recharge threshold is factory set. Refer to **Section 1.0 “Electrical Characteristics”** for recharge threshold options.

**Note:** Charge termination and automatic recharge features avoid constant charging Li-Ion batteries to prolong the life of Li-Ion batteries while keeping their capacity at healthy level.

## 4.9 Thermal Regulation

The MCP73837/8 limits the charge current based on the die temperature. The thermal regulation optimizes the charge cycle time while maintaining device reliability. **Figure 4-2** depicts the thermal regulation for the MCP73837/8. Refer to **Section 1.0 “Electrical Characteristics”** for thermal package resistances and **Section 6.1.1.2 “Thermal Considerations”** for calculating power dissipation.



**FIGURE 4-2:** Thermal Regulation.

## 4.10 Thermal Shutdown

The MCP73837/8 suspends charge if the die temperature exceeds 150°C. Charging will resume when the die temperature has cooled by approximately 10°C. The thermal shutdown is a secondary safety feature in the event that there is a failure within the thermal regulation circuitry.

# MCP73837/8

## 5.0 DETAILED DESCRIPTION

### 5.1 Analog Circuitry

#### 5.1.1 BATTERY MANAGEMENT INPUT SUPPLY ( $V_{DD}$ )

The  $V_{DD}$  input is the input supply to the MCP73837/8. The MCP73837/8 can be supplied by either AC-Adapter ( $V_{AC}$ ) or USB-Port ( $V_{USB}$ ) with autonomous source selection. The MCP73837/8 automatically enters a Power-down mode if the voltage on the  $V_{DD}$  input falls to within +100 mV of the battery voltage or below the UVLO voltage ( $V_{STOP}$ ). This feature prevents draining the battery pack when both the  $V_{AC}$  and  $V_{USB}$  supplies are not present.

#### 5.1.2 AC-ADAPTER CURRENT REGULATION SET (PROG1)

For the MCP73837/8, the charge current regulation can be scaled by placing a programming resistor ( $R_{PROG}$ ) from the PROG input to  $V_{SS}$ . The program resistor and the charge current are calculated using the following equation:

#### EQUATION 5-1:

$$I_{REG} = \frac{1000V}{R_{PROG}}$$

Where:

$$\begin{aligned} R_{PROG} &= \text{kilo-ohms (k}\Omega\text{)} \\ I_{REG} &= \text{milli-ampere (mA)} \end{aligned}$$

The preconditioning current and the charge termination current are ratiometric to the fast charge current based on the selected device options.

#### 5.1.3 BATTERY CHARGE CONTROL OUTPUT ( $V_{BAT}$ )

The battery charge control output is the drain terminal of an internal P-channel MOSFET. The MCP73837/8 provides constant current and voltage regulation to the battery pack by controlling this MOSFET in the linear region. The battery charge control output should be connected to the positive terminal of the battery pack.

#### 5.1.4 TEMPERATURE QUALIFICATION (THERM)

The MCP73837/8 continuously monitors battery temperature during a charge cycle by measuring the voltage between the THERM and the  $V_{SS}$  pins. An internal 50  $\mu$ A current source provides the bias for the most common 10 k $\Omega$  negative-temperature coefficient (NTC) or positive-temperature coefficient (PTC) thermistors. The current source is controlled, avoiding measurement sensitivity to fluctuations in the supply voltage ( $V_{DD}$ ). The MCP73837/8 compares the voltage

at the THERM pin to factory set thresholds of 1.20V and 0.25V, typically. Once a voltage outside the thresholds is detected during a charge cycle, the MCP73837/8 immediately suspends the charge cycle.

The MCP73837/8 suspends charge by turning off the pass transistor and holding the timer value. The charge cycle resumes when the voltage at the THERM pin returns to the normal range.

If temperature monitoring is not required, place a standard 10 k $\Omega$  resistor from THERM to  $V_{SS}$ .

#### 5.1.5 SYSTEM TEST (LDO) MODE

The MCP73837/8 can be placed in a system test mode. In this mode, the MCP73837/8 operates as a low drop-out linear regulator (LDO). The output voltage is regulated to the factory set voltage regulation option. The available output current is limited to the programmed fast charge current. For stability, the  $V_{BAT}$  output must be bypassed to  $V_{SS}$  with a minimum capacitance of 1  $\mu$ F for output currents up to 250 mA. A minimum capacitance of 4.7  $\mu$ F is required for output currents above 250 mA.

The system test mode is entered by driving the THERM input greater than ( $V_{DD} - 100$  mV) with no battery connected to the output. In this mode, the MCP73837/8 can be used to power the system without a battery being present.

**Note 1:**  $I_{THERM}$  is disabled during shutdown, stand-by, and system test modes.

**2:** A pull-down current source on the THERM input is active only in stand-by and system test modes.

**3:** During system test mode, the PROG input sets the available output current limit.

**4:** System test mode shall be exited by releasing the THERM input or cycling input power.

### 5.2 Digital Circuitry

#### 5.2.1 STATUS INDICATORS AND POWER GOOD ( $\overline{PG}$ ) OPTION

The charge status outputs have two different states: Low (L), and High Impedance (Hi-Z). The charge status outputs can be used to illuminate LEDs. Optionally, the charge status outputs can be used as an interface to a host microcontroller. [Table 5-1](#) summarizes the state of the status outputs during a charge cycle.

## 5.2.2 USB-PORT CURRENT REGULATION SELECT (PROG2)

For the MCP73837/8, driving the PROG2 input to a logic Low selects the low charge current setting (maximum 100 mA). Driving the PROG2 input to a logic High selects the high charge current setting (maximum 500 mA).

**TABLE 5-1: STATUS OUTPUTS**

| CHARGE CYCLE STATE        | STAT1 | STAT2 | PG   |
|---------------------------|-------|-------|------|
| Shutdown                  | Hi-Z  | Hi-Z  | Hi-Z |
| Standby                   | Hi-Z  | Hi-Z  | L    |
| Preconditioning           | L     | Hi-Z  | L    |
| Constant Current          | L     | Hi-Z  | L    |
| Constant Voltage          | L     | Hi-Z  | L    |
| Charge Complete - Standby | Hi-Z  | L     | L    |
| Temperature Fault         | Hi-Z  | Hi-Z  | L    |
| Timer Fault               | Hi-Z  | Hi-Z  | L    |
| System Test Mode          | L     | L     | L    |

## 5.2.3 POWER GOOD ( $\overline{\text{PG}}$ ) OPTION

The power good ( $\overline{\text{PG}}$ ) option is a pseudo open-drain output. The PG output can sink current, but not source current. However, there is a diode path back to the input, and as such, the output should be pulled up only to the input. The PG output is low whenever the input to the MCP73837 is above the UVLO threshold and greater than the battery voltage. If the supply voltage is above the UVLO, but below  $V_{\text{REG}}(\text{typical})+0.3\text{V}$ , the MCP73837 will pulse the PG output as the device determines if a battery is present. The PG option is available only on MCP73837.

## 5.2.4 TIMER ENABLE ( $\overline{\text{TE}}$ ) OPTION

The timer enable ( $\overline{\text{TE}}$ ) input option is used to enable or disable the internal timer. A low signal on this pin enables the internal timer and a high signal disables the internal timer. The  $\overline{\text{TE}}$  input can be used to disable the timer when the charger is supplying current to charge the battery and power the system load. The  $\overline{\text{TE}}$  input is compatible with 1.8V logic. The  $\overline{\text{TE}}$  option is available only on MCP73838.

## 5.2.5 DEVICE DISABLE (PROG1/2)

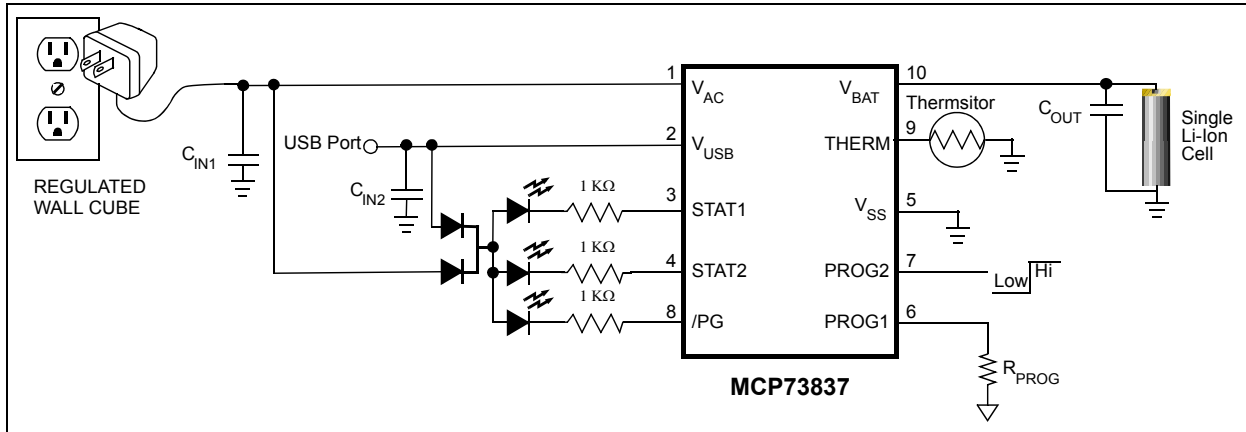
The current regulation set input pin (PROG1/2) can be used to terminate a charge at any time during the charge cycle, as well as to initiate a charge cycle or to initiate a recharge cycle. Placing a programming resistor from the PROG1/2 input to  $V_{\text{SS}}$  enables the device. Allowing the PROG1/2 input to float or applying a logic-high input signal, disables the device and terminates a charge cycle. When disabled, the device's supply current is reduced to 75  $\mu\text{A}$ , typically.

# MCP73837/8

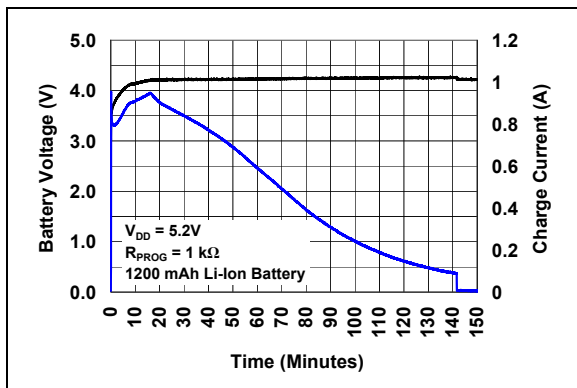
## 6.0 APPLICATIONS

The MCP73837/8 devices are designed to operate in conjunction with a host microcontroller or in stand-alone applications. The MCP73837/8 devices provide the preferred charge algorithm for Lithium-Ion and

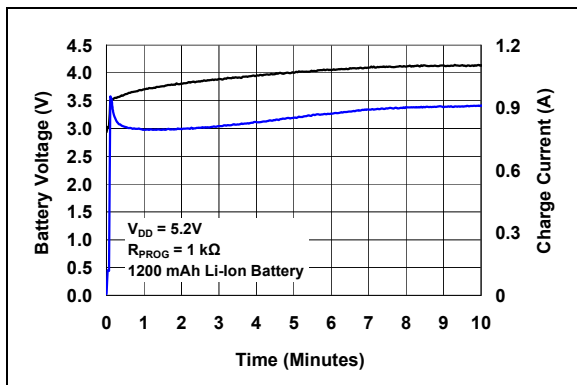
Lithium-Polymer cells Constant-current followed by Constant-voltage. [Figure 6-1](#) depicts a typical stand-alone MCP73837 application circuit, while [Figure 6-2](#) and [Figure 6-3](#) depict the accompanying charge profile.



**FIGURE 6-1:** MCP73837 Typical Stand-Alone Application Circuit.



**FIGURE 6-2:** Typical Charge Profile (1200 mAh Li-Ion Battery).



**FIGURE 6-3:** Typical Charge Profile in Thermal Regulation (1200 mAh Li-Ion Battery).

## 6.1 Application Circuit Design

Due to the low efficiency of linear charging, the most important factors are **thermal design** and **cost**, which are a direct function of the input voltage, output current, and thermal impedance between the battery charger and the ambient cooling air. The worst-case situation is when the device has transitioned from the Preconditioning mode to the Constant Current mode. In this situation, the battery charger has to dissipate the maximum power. A trade-off must be made between the charge current, cost, and thermal requirements of the charger.

### 6.1.1 COMPONENT SELECTION

Selection of the external components in [Figure 6-1](#) is crucial to the integrity and reliability of the charging system. The following discussion is intended as a guide for the component selection process.

#### 6.1.1.1 Charge Current

The preferred fast charge current for Lithium-Ion cells should always follow references and guidance from battery manufacturers. For example, programming 700 mA fast charge current for a 1000 mAh Li-Ion battery pack if its preferred fast charge rate is 0.7C. This will result the shortest charge cycle time without degradation a battery's life and performance.

#### 6.1.1.2 Thermal Considerations

The worst-case power dissipation in the battery charger occurs when the input voltage is at the maximum and the device has transitioned from the Preconditioning mode to the Constant-current mode. In this case, the power dissipation is:

## EQUATION 6-1:

$$PowerDissipation = (V_{DDMAX} - V_{PTHMIN}) \times I_{REGMAX}$$

Where:

- $V_{DDMAX}$  = the maximum input voltage
- $I_{REGMAX}$  = the maximum fast charge current
- $V_{PTHMIN}$  = the minimum transition threshold voltage

For example, power dissipation with a 5V, ±10% input voltage source and 500 mA, ±10% fast charge current is:

## EXAMPLE 6-1:

$$PowerDissipation = (5.5V - 2.7V) \times 550mA = 1.54W$$

This power dissipation with the battery charger in the MSOP-10 package will cause thermal regulation to be entered as depicted in [Figure 6-3](#). Alternatively, the 3 mm x 3 mm DFN package could be utilized to reduce the charge cycle times.

### 6.1.1.3 External Capacitors

The MCP73837/8 is stable with or without a battery load. In order to maintain good AC stability in the Constant Voltage mode, a minimum capacitance of 1 µF is recommended to bypass the  $V_{BAT}$  pin to  $V_{SS}$ . This capacitance provides compensation when there is no battery load. In addition, the battery and interconnections appear inductive at high frequencies. These elements are in the control feedback loop during Constant Voltage mode. Therefore, the bypass capacitance may be necessary to compensate for the inductive nature of the battery pack.

Virtually any good quality output filter capacitor can be used, independent of the capacitor's minimum Effective Series Resistance (ESR) value. The actual value of the capacitor (and its associated ESR) depends on the output load current. A 1 µF ceramic, tantalum, or aluminum electrolytic capacitor at the output is usually sufficient to ensure stability for output currents up to 500 mA.

### 6.1.1.4 Reverse-Blocking Protection

The MCP73837/8 provides protection from a faulted or shorted input. Without the protection, a faulted or shorted input would discharge the battery pack through the body diode of the internal pass transistor.

### 6.1.1.5 Charge Inhibit

The current regulation set input pin (PROG1/2) can be used to terminate a charge at any time during the charge cycle, as well as to initiate a charge cycle or initiate a recharge cycle.

Placing a programming resistor from the PROG1 input to  $V_{SS}$  or driving PROG2 to logic High or Low enables the device. Allowing either the PROG1 or PROG2 input float disables the device and terminates a charge cycle. When disabled, the device's supply current is reduced to 75 µA, typically.

### 6.1.1.6 Temperature Monitoring

The charge temperature window can be set by placing fixed value resistors in series-parallel with a thermistor. The resistance values of  $R_{T1}$  and  $R_{T2}$  can be calculated with the following equations in order to set the temperature window of interest.

For NTC thermistors:

## EQUATION 6-2:

$$24k\Omega = R_{T1} + \frac{R_{T2} \times R_{COLD}}{R_{T2} + R_{COLD}}$$

$$5k\Omega = R_{T1} + \frac{R_{T2} \times R_{HOT}}{R_{T2} + R_{HOT}}$$

Where:

- $R_{T1}$  = the fixed series resistance
- $R_{T2}$  = the fixed parallel resistance
- $R_{COLD}$  = the thermistor resistance at the lower temperature of interest
- $R_{HOT}$  = the thermistor resistance at the upper temperature of interest

For example, by utilizing a 10 kΩ at 25°C NTC thermistor with a sensitivity index,  $\beta$ , of 3892, the charge temperature range can be set to 0°C - 50°C by placing a 1.54 kΩ resistor in series ( $R_{T1}$ ), and a 69.8 kΩ resistor in parallel ( $R_{T2}$ ) with the thermistor.

### 6.1.1.7 Charge Status Interface

A status output provides information on the state of charge. The output can be used to illuminate external LEDs or interface to a host microcontroller. Refer to [Figure 5-1](#) for a summary of the state of the status output during a charge cycle.

## 6.2 PCB Layout Issues

For optimum voltage regulation, place the battery pack as close as possible to the device's  $V_{BAT}$  and  $V_{SS}$  pins, recommended to minimize voltage drops along the high current-carrying PCB traces.

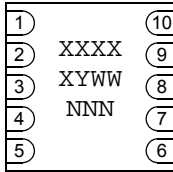
If the PCB layout is used as a heatsink, adding many vias in the heatsink pad can help conduct more heat to the backplane of the PCB, thus reducing the maximum junction temperature.

# MCP73837/8

## 7.0 PACKAGING INFORMATION

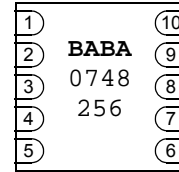
### 7.1 Package Marking Information

10-Lead DFN



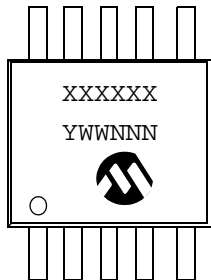
| Part Number *   | Marking Code | Part Number *    | Marking Code |
|-----------------|--------------|------------------|--------------|
| MCP73837-FCI/MF | BABA         | MCP73837T-FCI/MF | BABA         |
| MCP73837-FJI/MF | BABB         | MCP73837T-FJI/MF | BABB         |
| MCP73837-NVI/MF | BABC         | MCP73837T-NVI/MF | BABC         |
| MCP73838-FCI/MF | BACA         | MCP73838T-FCI/MF | BACA         |
| MCP73838-FJI/MF | BACB         | MCP73838T-FJI/MF | BACB         |
| MCP73838-NVI/MF | BACC         | MCP73838T-NVI/MF | BACC         |

Example:



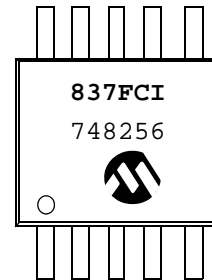
\* Consult Factory for Alternative Device Options.

10-Lead MSOP \*\*



| Part Number *   | Marking Code | Part Number *    | Marking Code |
|-----------------|--------------|------------------|--------------|
| MCP73837-FCI/UN | 837FCI       | MCP73837T-FCI/UN | 837FCI       |
| MCP73837-FJI/UN | 837FJI       | MCP73837T-FJI/UN | 837FJI       |
| MCP73837-NVI/UN | 837NVI       | MCP73837T-NVI/UN | 837NVI       |
| MCP73838-FCI/UN | 838FCI       | MCP73838T-FCI/UN | 838FCI       |
| MCP73838-FJI/UN | 838FJI       | MCP73838T-FJI/UN | 838FJI       |
| MCP73838-NVI/UN | 838NVI       | MCP73838T-NVI/UN | 838NVI       |

Example:



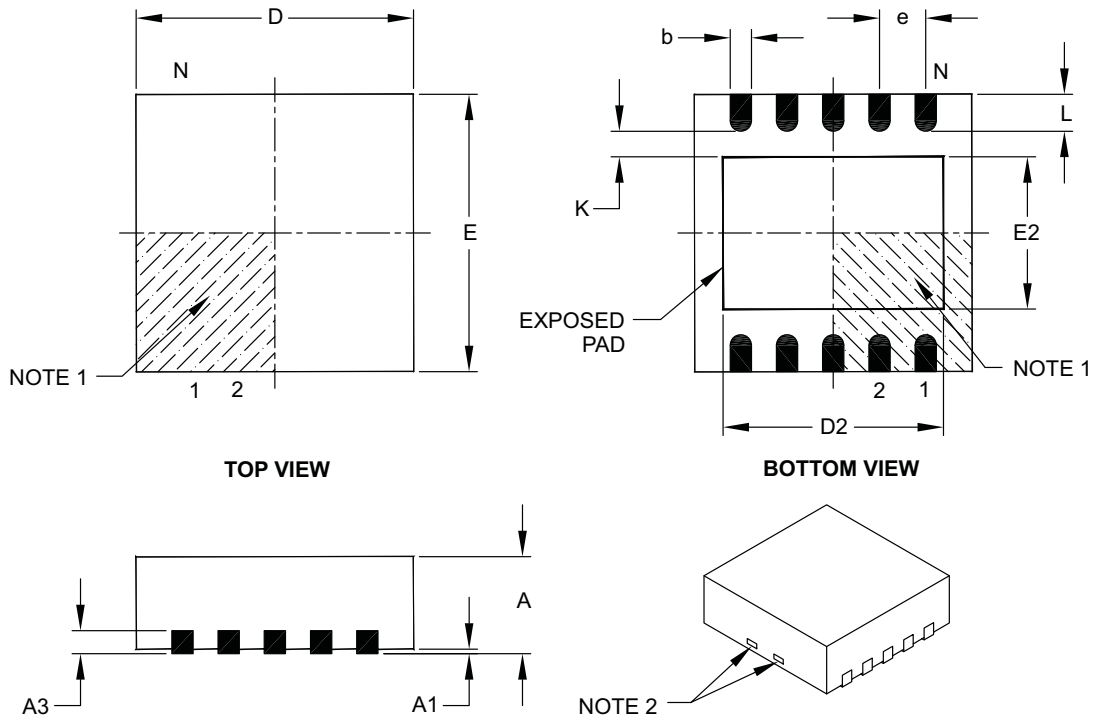
\* Consult Factory for Alternative Device Options.

\*\* Consult Factory for MSOP Package Availability.

|                |   |  |
|----------------|---|--|
| <b>Legend:</b> | XX...X  | Customer-specific information  |
|                | Y   | Year code (last digit of calendar year)  |
|                | YY  | Year code (last 2 digits of calendar year)   |
|                | WW  | Week code (week of January 1 is week '01')   |
|                | NNN   | Alphanumeric traceability code   |
|                | (e3)  | Pb-free JEDEC designator for Matte Tin (Sn)  |
|                | *   | This package is Pb-free. The Pb-free JEDEC designator (e3) can be found on the outer packaging for this package. |
| <b>Note:</b>   | In the event the full Microchip part number cannot be marked on one line, it will be carried over to the next line, thus limiting the number of available characters for customer-specific information. |  |

## 10-Lead Plastic Dual Flat, No Lead Package (MF) – 3x3x0.9 mm Body [DFN]

**Note:** For the most current package drawings, please see the Microchip Packaging Specification located at <http://www.microchip.com/packaging>



| Dimension Limits       | Units | MILLIMETERS |      |      |
|------------------------|-------|-------------|------|------|
|                        |       | MIN         | NOM  | MAX  |
| Number of Pins         | N     | 10          |      |      |
| Pitch                  | e     | 0.50 BSC    |      |      |
| Overall Height         | A     | 0.80        | 0.90 | 1.00 |
| Standoff               | A1    | 0.00        | 0.02 | 0.05 |
| Contact Thickness      | A3    | 0.20 REF    |      |      |
| Overall Length         | D     | 3.00 BSC    |      |      |
| Exposed Pad Length     | D2    | 2.20        | 2.35 | 2.48 |
| Overall Width          | E     | 3.00 BSC    |      |      |
| Exposed Pad Width      | E2    | 1.40        | 1.58 | 1.75 |
| Contact Width          | b     | 0.18        | 0.25 | 0.30 |
| Contact Length         | L     | 0.30        | 0.40 | 0.50 |
| Contact-to-Exposed Pad | K     | 0.20        | –    | –    |

**Notes:**

- Pin 1 visual index feature may vary, but must be located within the hatched area.
- Package may have one or more exposed tie bars at ends.
- Package is saw singulated.
- Dimensioning and tolerancing per ASME Y14.5M.

BSC: Basic Dimension. Theoretically exact value shown without tolerances.

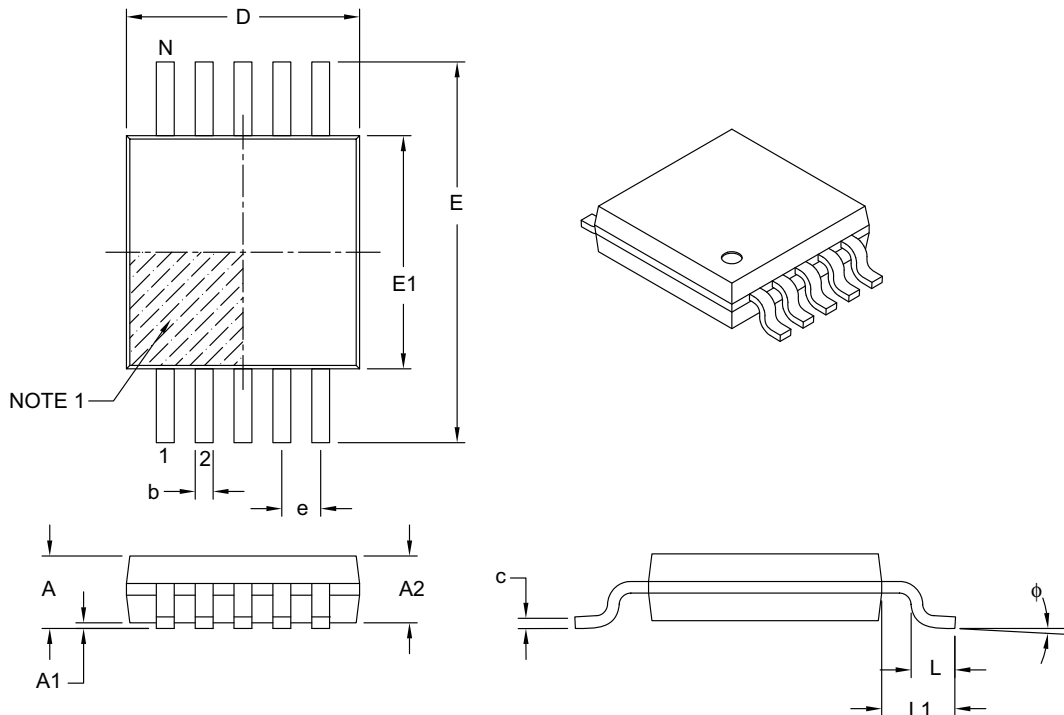
REF: Reference Dimension, usually without tolerance, for information purposes only.

Microchip Technology Drawing C04-063B

# MCP73837/8

## 10-Lead Plastic Micro Small Outline Package (UN) [MSOP]

**Note:** For the most current package drawings, please see the Microchip Packaging Specification located at <http://www.microchip.com/packaging>



| Dimension Limits         | Units  | MILLIMETERS |      |      |
|--------------------------|--------|-------------|------|------|
|                          |        | MIN         | NOM  | MAX  |
| Number of Pins           | N      | 10          |      |      |
| Pitch                    | e      | 0.50 BSC    |      |      |
| Overall Height           | A      | –           | –    | 1.10 |
| Molded Package Thickness | A2     | 0.75        | 0.85 | 0.95 |
| Standoff                 | A1     | 0.00        | –    | 0.15 |
| Overall Width            | E      | 4.90 BSC    |      |      |
| Molded Package Width     | E1     | 3.00 BSC    |      |      |
| Overall Length           | D      | 3.00 BSC    |      |      |
| Foot Length              | L      | 0.40        | 0.60 | 0.80 |
| Footprint                | L1     | 0.95 REF    |      |      |
| Foot Angle               | $\phi$ | 0°          | –    | 8°   |
| Lead Thickness           | c      | 0.08        | –    | 0.23 |
| Lead Width               | b      | 0.15        | –    | 0.33 |

**Notes:**

- Pin 1 visual index feature may vary, but must be located within the hatched area.
- Dimensions D and E1 do not include mold flash or protrusions. Mold flash or protrusions shall not exceed 0.15 mm per side.
- Dimensioning and tolerancing per ASME Y14.5M.

BSC: Basic Dimension. Theoretically exact value shown without tolerances.

REF: Reference Dimension, usually without tolerance, for information purposes only.

Microchip Technology Drawing C04-021B



## APPENDIX A: REVISION HISTORY

### Revision A (November 2007)

- Original Release of this Document.

# MCP73837/8

---

NOTES:

## PRODUCT IDENTIFICATION SYSTEM

To order or obtain information, e.g., on pricing or delivery, refer to the factory or the listed sales office.

| PART NO.  | XX              | X/    | XX      |   |
|---|-----------------|-------|---------|---|
| Device  | Output Options* | Temp. | Package |   |
| <p>Device:                   MCP73837: 1A Fully Integrated Charger, PG function on pin 8</p> <p>                              MCP73837T: 1A Fully Integrated Charger, PG function on pin 8 (Tape and Reel)</p> <p>                              MCP73838: 1A Fully Integrated Charger, TE function on pin 8</p> <p>                              MCP73838T: 1A Fully Integrated Charger, TE function on pin 8 (Tape and Reel)</p> |                 |       |         |   |
| <p>Output Options **       * Refer to table below for different operational options.</p> <p>                              ** Consult Factory for Alternative Device Options.</p>  |                 |       |         |   |
| <p>Temperature:           I     = -40°C to +85°C</p>  |                 |       |         |   |
| <p>Package Type:          MF = Plastic Dual Flat No Lead (DFN) (3x3x0.9 mm Body), 10-lead</p> <p>                              UN = Plastic Micro Small Outline Package (MSOP***), 10-lead</p>  |                 |       |         |   |
|   |                 |       |         | <p><b>Examples: **</b></p> <p>a) MCP73837-FCI/UN: 10-lead MSOP pkg.</p> <p>b) MCP73837-FJI/UN: 10-lead MSOP pkg.</p> <p>c) MCP73837-NVI/UN: 10-lead MSOP pkg.</p> <p>d) MCP73837-FCI/MF: 10-lead DFN pkg.</p> <p>e) MCP73837-FJI/MF: 10-lead DFN pkg.</p> <p>f) MCP73837-NVI/MF: 10-lead DFN pkg.</p><br><p>a) MCP73838-FCI/UN: 10-lead MSOP pkg.</p> <p>b) MCP73838-FJI/UN: 10-lead MSOP pkg.</p> <p>c) MCP73838-NVI/UN: 10-lead MSOP pkg.</p> <p>d) MCP73838-FCI/MF: 10-lead DFN pkg.</p> <p>e) MCP73838-FJI/MF: 10-lead DFN pkg.</p> <p>f) MCP73838-NVI/MF: 10-lead DFN pkg.</p><br><p>** Consult Factory for Alternative Device Options</p> |

### \* Operational Output Options

| Output Options | V <sub>REG</sub> | I <sub>PREG</sub> /I <sub>REG</sub> | V <sub>PTH</sub> /V <sub>REG</sub> | I <sub>TERM</sub> /I <sub>REG</sub> | V <sub>RTH</sub> /V <sub>REG</sub> | Timer Period |
|----------------|------------------|-------------------------------------|------------------------------------|-------------------------------------|------------------------------------|--------------|
| AM             | 4.20V            | 10%                                 | 71.5%                              | 7.5%                                | 96.5%                              | 0 hours      |
| BZ             | 4.20V            | 100%                                | N/A                                | 7.5%                                | 96.5%                              | 0 hours      |
| FC             | 4.20V            | 10%                                 | 71.5%                              | 7.5%                                | 96.5%                              | 6 hours      |
| GP             | 4.20V            | 100%                                | N/A                                | 7.5%                                | 96.5%                              | 6 hours      |
| G8             | 4.20V            | 10%                                 | 71.5%                              | 7.5%                                | 96.5%                              | 8 hours      |
| NV             | 4.35V            | 10%                                 | 71.5%                              | 7.5%                                | 96.5%                              | 6 hours      |
| YA             | 4.40V            | 10%                                 | 71.5%                              | 7.5%                                | 96.5%                              | 6 hours      |
| 6S             | 4.50V            | 10%                                 | 71.5%                              | 7.5%                                | 96.5%                              | 6 hours      |
| B6             | 4.20V            | 10%                                 | 66.5%                              | 5.0%                                | 96.5%                              | 4 hours      |
| CN             | 4.20V            | 10%                                 | 71.5%                              | 20%                                 | 94%                                | 4 hours      |

\*\* Consult Factory for Alternative Device Options.

\*\*\* Consult Factory for MSOP Package Availability

# MCP73837/8

---

NOTES:

---

**Note the following details of the code protection feature on Microchip devices:**

- Microchip products meet the specification contained in their particular Microchip Data Sheet.
- Microchip believes that its family of products is one of the most secure families of its kind on the market today, when used in the intended manner and under normal conditions.
- There are dishonest and possibly illegal methods used to breach the code protection feature. All of these methods, to our knowledge, require using the Microchip products in a manner outside the operating specifications contained in Microchip's Data Sheets. Most likely, the person doing so is engaged in theft of intellectual property.
- Microchip is willing to work with the customer who is concerned about the integrity of their code.
- Neither Microchip nor any other semiconductor manufacturer can guarantee the security of their code. Code protection does not mean that we are guaranteeing the product as “unbreakable.”

Code protection is constantly evolving. We at Microchip are committed to continuously improving the code protection features of our products. Attempts to break Microchip's code protection feature may be a violation of the Digital Millennium Copyright Act. If such acts allow unauthorized access to your software or other copyrighted work, you may have a right to sue for relief under that Act.

---

Information contained in this publication regarding device applications and the like is provided only for your convenience and may be superseded by updates. It is your responsibility to ensure that your application meets with your specifications. MICROCHIP MAKES NO REPRESENTATIONS OR WARRANTIES OF ANY KIND WHETHER EXPRESS OR IMPLIED, WRITTEN OR ORAL, STATUTORY OR OTHERWISE, RELATED TO THE INFORMATION, INCLUDING BUT NOT LIMITED TO ITS CONDITION, QUALITY, PERFORMANCE, MERCHANTABILITY OR FITNESS FOR PURPOSE. Microchip disclaims all liability arising from this information and its use. Use of Microchip devices in life support and/or safety applications is entirely at the buyer's risk, and the buyer agrees to defend, indemnify and hold harmless Microchip from any and all damages, claims, suits, or expenses resulting from such use. No licenses are conveyed, implicitly or otherwise, under any Microchip intellectual property rights.

**Trademarks**

The Microchip name and logo, the Microchip logo, Accuron, dsPIC, KEELOQ, KEELOQ logo, microID, MPLAB, PIC, PICmicro, PICSTART, PRO MATE, rPIC and SmartShunt are registered trademarks of Microchip Technology Incorporated in the U.S.A. and other countries.


AmpLab, FilterLab, Linear Active Thermistor, Migratable Memory, MXDEV, MXLAB, SEEVAL, SmartSensor and The Embedded Control Solutions Company are registered trademarks of Microchip Technology Incorporated in the U.S.A.

Analog-for-the-Digital Age, Application Maestro, CodeGuard, dsPICDEM, dsPICDEM.net, dsPICworks, dsSPEAK, ECAN, ECONOMONITOR, FanSense, FlexROM, fuzzyLAB, In-Circuit Serial Programming, ICSP, ICEPIC, Mindi, MiWi, MPASM, MPLAB Certified logo, MPLIB, MPLINK, PICkit, PICDEM, PICDEM.net, PICLAB, PICtail, PowerCal, PowerInfo, PowerMate, PowerTool, REAL ICE, rLAB, Select Mode, Smart Serial, SmartTel, Total Endurance, UNI/O, WiperLock and ZENA are trademarks of Microchip Technology Incorporated in the U.S.A. and other countries.

SQTP is a service mark of Microchip Technology Incorporated in the U.S.A.

All other trademarks mentioned herein are property of their respective companies.

© 2007, Microchip Technology Incorporated, Printed in the U.S.A., All Rights Reserved.

 Printed on recycled paper.

**QUALITY MANAGEMENT SYSTEM**  
**CERTIFIED BY DNV**  
**== ISO/TS 16949:2002 ==**

*Microchip received ISO/TS-16949:2002 certification for its worldwide headquarters, design and wafer fabrication facilities in Chandler and Tempe, Arizona; Gresham, Oregon and design centers in California and India. The Company's quality system processes and procedures are for its PIC® MCUs and dsPIC® DSCs, KEELOQ® code hopping devices, Serial EEPROMs, microperipherals, nonvolatile memory and analog products. In addition, Microchip's quality system for the design and manufacture of development systems is ISO 9001:2000 certified.*



---

---

## WORLDWIDE SALES AND SERVICE

---

---

### AMERICAS

**Corporate Office**  
2355 West Chandler Blvd.  
Chandler, AZ 85224-6199  
Tel: 480-792-7200  
Fax: 480-792-7277  
Technical Support:  
<http://support.microchip.com>  
Web Address:  
[www.microchip.com](http://www.microchip.com)

#### Atlanta

Duluth, GA  
Tel: 678-957-9614  
Fax: 678-957-1455

#### Boston

Westborough, MA  
Tel: 774-760-0087  
Fax: 774-760-0088

#### Chicago

Itasca, IL  
Tel: 630-285-0071  
Fax: 630-285-0075

#### Dallas

Addison, TX  
Tel: 972-818-7423  
Fax: 972-818-2924

#### Detroit

Farmington Hills, MI  
Tel: 248-538-2250  
Fax: 248-538-2260

#### Kokomo

Kokomo, IN  
Tel: 765-864-8360  
Fax: 765-864-8387

#### Los Angeles

Mission Viejo, CA  
Tel: 949-462-9523  
Fax: 949-462-9608

#### Santa Clara

Santa Clara, CA  
Tel: 408-961-6444  
Fax: 408-961-6445

#### Toronto

Mississauga, Ontario,  
Canada  
Tel: 905-673-0699  
Fax: 905-673-6509

### ASIA/PACIFIC

**Asia Pacific Office**  
Suites 3707-14, 37th Floor  
Tower 6, The Gateway  
Harbour City, Kowloon  
Hong Kong  
Tel: 852-2401-1200  
Fax: 852-2401-3431

**Australia - Sydney**  
Tel: 61-2-9868-6733  
Fax: 61-2-9868-6755

**China - Beijing**  
Tel: 86-10-8528-2100  
Fax: 86-10-8528-2104

**China - Chengdu**  
Tel: 86-28-8665-5511  
Fax: 86-28-8665-7889

**China - Fuzhou**  
Tel: 86-591-8750-3506  
Fax: 86-591-8750-3521

**China - Hong Kong SAR**  
Tel: 852-2401-1200  
Fax: 852-2401-3431

**China - Nanjing**  
Tel: 86-25-8473-2460  
Fax: 86-25-8473-2470

**China - Qingdao**  
Tel: 86-532-8502-7355  
Fax: 86-532-8502-7205

**China - Shanghai**  
Tel: 86-21-5407-5533  
Fax: 86-21-5407-5066

**China - Shenyang**  
Tel: 86-24-2334-2829  
Fax: 86-24-2334-2393

**China - Shenzhen**  
Tel: 86-755-8203-2660  
Fax: 86-755-8203-1760

**China - Shunde**  
Tel: 86-757-2839-5507  
Fax: 86-757-2839-5571

**China - Wuhan**  
Tel: 86-27-5980-5300  
Fax: 86-27-5980-5118

**China - Xian**  
Tel: 86-29-8833-7252  
Fax: 86-29-8833-7256

### ASIA/PACIFIC

**India - Bangalore**  
Tel: 91-80-4182-8400  
Fax: 91-80-4182-8422

**India - New Delhi**  
Tel: 91-11-4160-8631  
Fax: 91-11-4160-8632

**India - Pune**  
Tel: 91-20-2566-1512  
Fax: 91-20-2566-1513

**Japan - Yokohama**  
Tel: 81-45-471- 6166  
Fax: 81-45-471-6122

**Korea - Daegu**  
Tel: 82-53-744-4301  
Fax: 82-53-744-4302

**Korea - Seoul**  
Tel: 82-2-554-7200  
Fax: 82-2-558-5932 or  
82-2-558-5934

**Malaysia - Kuala Lumpur**  
Tel: 60-3-6201-9857  
Fax: 60-3-6201-9859

**Malaysia - Penang**  
Tel: 60-4-227-8870  
Fax: 60-4-227-4068

**Philippines - Manila**  
Tel: 63-2-634-9065  
Fax: 63-2-634-9069

**Singapore**  
Tel: 65-6334-8870  
Fax: 65-6334-8850

**Taiwan - Hsin Chu**  
Tel: 886-3-572-9526  
Fax: 886-3-572-6459

**Taiwan - Kaohsiung**  
Tel: 886-7-536-4818  
Fax: 886-7-536-4803

**Taiwan - Taipei**  
Tel: 886-2-2500-6610  
Fax: 886-2-2508-0102

**Thailand - Bangkok**  
Tel: 66-2-694-1351  
Fax: 66-2-694-1350

### EUROPE

**Austria - Wels**  
Tel: 43-7242-2244-39  
Fax: 43-7242-2244-393

**Denmark - Copenhagen**  
Tel: 45-4450-2828  
Fax: 45-4485-2829

**France - Paris**  
Tel: 33-1-69-53-63-20  
Fax: 33-1-69-30-90-79

**Germany - Munich**  
Tel: 49-89-627-144-0  
Fax: 49-89-627-144-44

**Italy - Milan**  
Tel: 39-0331-742611  
Fax: 39-0331-466781

**Netherlands - Drunen**  
Tel: 31-416-690399  
Fax: 31-416-690340

**Spain - Madrid**  
Tel: 34-91-708-08-90  
Fax: 34-91-708-08-91

**UK - Wokingham**  
Tel: 44-118-921-5869  
Fax: 44-118-921-5820

10/05/07

# Mouser Electronics

Authorized Distributor

Click to View Pricing, Inventory, Delivery & Lifecycle Information:

## Microchip:

[MCP73837T-NVI/MF](#) [MCP73838T-NVI/MF](#) [MCP73837-FJI/UN](#) [MCP73837-FCI/UN](#) [MCP73838T-FCI/UN](#)  
[MCP73838-FJI/UN](#) [MCP73838T-FJI/MF](#) [MCP73837-NVI/MF](#) [MCP73838-NVI/MF](#) [MCP73837-FJI/MF](#) [MCP73838T-](#)  
[FJI/UN](#) [MCP73838-FCI/UN](#) [MCP73838-FJI/MF](#) [MCP73837T-FJI/MF](#) [MCP73837T-FCI/UN](#) [MCP73837T-FJI/UN](#)  
[MCP73837-FCI/MF](#) [MCP73837-NVI/UN](#) [MCP73837T-FCI/MF](#) [MCP73837T-NVI/UN](#) [MCP73838-FCI/MF](#) [MCP73838-](#)  
[NVI/UN](#) [MCP73838T-FCI/MF](#) [MCP73838T-NVI/UN](#)



Компания «ЭлектроПласт» предлагает заключение долгосрочных отношений при поставках импортных электронных компонентов на взаимовыгодных условиях!

Наши преимущества:

- Оперативные поставки широкого спектра электронных компонентов отечественного и импортного производства напрямую от производителей и с крупнейших мировых складов;
- Поставка более 17-ти миллионов наименований электронных компонентов;
- Поставка сложных, дефицитных, либо снятых с производства позиций;
- Оперативные сроки поставки под заказ (от 5 рабочих дней);
- Экспресс доставка в любую точку России;
- Техническая поддержка проекта, помощь в подборе аналогов, поставка прототипов;
- Система менеджмента качества сертифицирована по Международному стандарту ISO 9001;
- Лицензия ФСБ на осуществление работ с использованием сведений, составляющих государственную тайну;
- Поставка специализированных компонентов (Xilinx, Altera, Analog Devices, Intersil, Interpoint, Microsemi, Aeroflex, Peregrine, Syfer, Eurofarad, Texas Instrument, Miteq, Cobham, E2V, MA-COM, Hittite, Mini-Circuits, General Dynamics и др.);

Помимо этого, одним из направлений компании «ЭлектроПласт» является направление «Источники питания». Мы предлагаем Вам помощь Конструкторского отдела:

- Подбор оптимального решения, техническое обоснование при выборе компонента;
- Подбор аналогов;
- Консультации по применению компонента;
- Поставка образцов и прототипов;
- Техническая поддержка проекта;
- Защита от снятия компонента с производства.



#### Как с нами связаться

**Телефон:** 8 (812) 309 58 32 (многоканальный)

**Факс:** 8 (812) 320-02-42

**Электронная почта:** [org@eplast1.ru](mailto:org@eplast1.ru)

**Адрес:** 198099, г. Санкт-Петербург, ул. Калинина, дом 2, корпус 4, литера А.