

Applications

- General Purpose Wideband Gain Block
- Electronic Warfare
- Military & Commercial Radar
- Military Communications
- Commercial Communications
- Instrumentation

Product Features

- Frequency Range: 2 – 30 GHz
- Small Signal Gain: 11.5 dB mid-band
- Return Loss: >9 dB
- NF: 3.4 dB typical
- P1dB: 8 dBm, $P_{SAT} = 12$ dBm at $P_{IN} = 5$ dBm
- OTOI: 17 dBm at $P_{out}/tone = 5$ dBm
- Bias: $V^+ = 5$ V ($V_D = 3$ V), $I_{DQ} = 50$ mA, $V_G = -1.5$ V Typical, $V_{CTRL} = 0$ V
- Package Dimensions: 5 x 5 x 1.5 mm

General Description

TriQuint's TGA3504-SM is a packaged wideband gain block with adjustable gain control giving the user extra flexibility to fine tune system performance. Operating from 2 to 30 GHz, the TGA3504-SM provides 8 dBm P1dB and 11 dB of small signal gain with return losses of greater than 9 dB.

The TGA3504-SM is fabricated on TriQuint's TQPHT15 0.15 μ m GaAs pHEMT process and is offered in a robust 5x5 mm air-cavity QFN. With integrated DC blocking caps and fully matched to 50ohms, the TGA3503-SM is easily integrated in both commercial and military system architectures.

Lead-free and RoHS compliant

Evaluation Boards are available upon request.

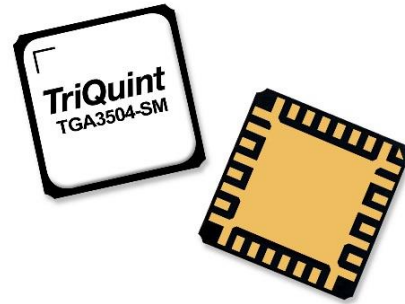

Functional Block Diagram

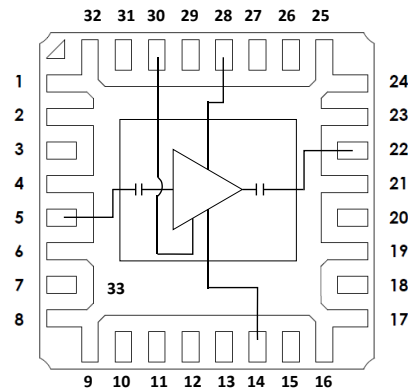

Pad Configuration

Pad No.	Symbol
1-4, 6-13, 15-21, 23-27, 29, 31-32	Gnd
5	RF _{IN}
14	V _{G1}
22	RF _{OUT}
28	V ⁺
30	V _{CTRL}
33	Gnd

Ordering Information

Part	ECCN	Description
TGA3504-SM	EAR99	2 – 30 GHz GaAs Wideband Gain Block

Absolute Maximum Ratings

Parameter	Value (1)
Bias Voltage (V^+)	10 V
Drain Voltage (V_D)	6 V
Gate Voltage Range (V_{G1})	-5 to 0 V
Control Voltage Range (V_{CTRL})	-1 to 3.9 V (2)
Drain Current (I_D)	72 mA
Gate Current (I_G)	-10 to 19 mA
Control Current (I_{CTRL})	-0.5 to 16 mA
Power Dissipation, 85 °C (P_{DISS})	1.3 W
Input Power, CW, 50 Ω , (P_{IN})	13 dBm
Channel temperature (T_{CH})	200 °C
Mounting Temperature (30 Seconds)	260 °C
Storage Temperature	-55 to 150 °C

Notes:

1. Operation of this device outside the parameter ranges given above may cause permanent damage. These are stress ratings only, and functional operation of the device at these conditions is not implied.
2. Assure $V_D - V_{CTRL} \leq 8$ V. Compute $V_D = V^+ - I_{DQ} \cdot 40$

Recommended Operating Conditions

Parameter	Value (1)
Supply Voltage (V^+)	5 V
Drain Voltage (V_D)	3 V
Drain Current (I_{DQ})	50 mA
Gate Voltage (V_{G1})	-1.5 V Typical
Control Voltage (V_{CTRL})	0 V
Temperature (T_{BASE})	-40 to 85 °C

Notes:

1. Electrical specifications are measured at specified test conditions. Specifications are not guaranteed overall operating conditions

Electrical Specifications

Test conditions unless otherwise noted: 25 °C, $V^+ = 5$ V, $I_{DQ} = 50$ mA, $V_{G1} = -1.5$ V Typical, $V_{CTRL} = 0$ V, CW

Parameter	Min	Typical	Max	Units
Operational Frequency Range	2		30	GHz
Small Signal Gain		>10		dB
Input Return Loss		>9		dB
Output Return Loss		>9		dB
Noise Figure		3.4		dB
Output Power at 1 dB Gain Compression		10		dBm
Output TOI at $P_{out}/tone = 5$ dBm		17		dBm

Thermal and Reliability Information

Parameter	Test Conditions	Value	Units
Thermal Resistance (θ_{JC}) ⁽¹⁾	$T_{base} = 85\text{ }^{\circ}\text{C}$, $V_{+} = 5\text{ V}$ $V_D = 3\text{ V}$, $V_{CTRL} = 0\text{ V}$, $I_{DQ} = 50\text{ mA}$, $P_{DISS} = 0.21\text{ W}$	48	$^{\circ}\text{C/W}$
Channel Temperature (T_{CH}) (No RF drive)		95	$^{\circ}\text{C}$
Median Lifetime (T_M)		1.2×10^9	Hrs
Thermal Resistance (θ_{JC}) ⁽¹⁾	$T_{base} = 85\text{ }^{\circ}\text{C}$, $V_{+} = 5\text{ V (CW)}$ $V_D = 3\text{ V}$, $V_{CTRL} = 0\text{ V}$, $I_{DQ} = 50\text{ mA}$, $I_{D_Drive} = 58\text{ mA}$ $P_{IN} = 5\text{ dBm}$, $P_{OUT} = 11\text{ dBm}$, $\text{Freq} = 16\text{ GHz}$, $P_{DISS} = 0.16\text{ W}$	42	$^{\circ}\text{C/W}$
Channel Temperature (T_{CH}) (Under RF drive)		92	$^{\circ}\text{C}$
Median Lifetime (T_M)		1.8×10^9	Hrs

Notes:

1. Thermal resistance measured at back of the package.

Test Conditions: $V_D = 6\text{ V}$; Failure Criteria is 10% reduction in I_{D_MAX}

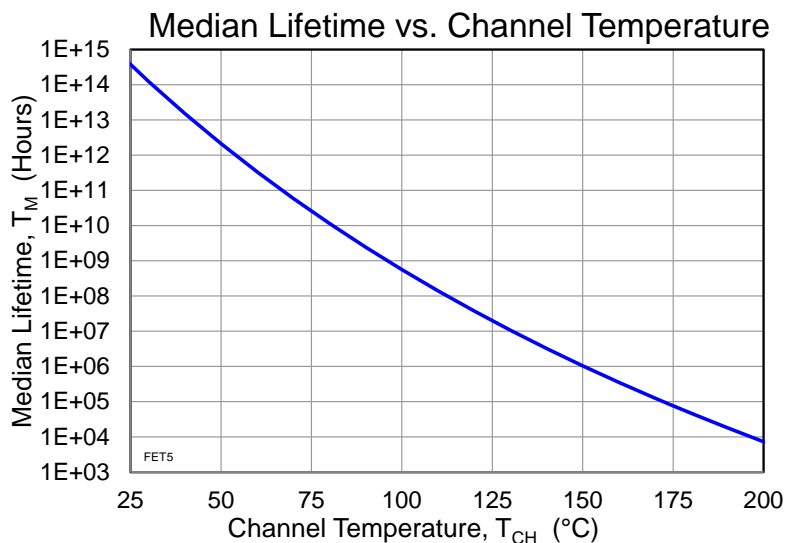

Typical Performance: Small Signal

Conditions unless otherwise specified: $V^+ = 5\text{ V}$, $I_{DQ} = 50\text{ mA}$, $V_{G1} = -1.5\text{ V}$ Typical, $V_{CTRL} = 0\text{ V}$, CW

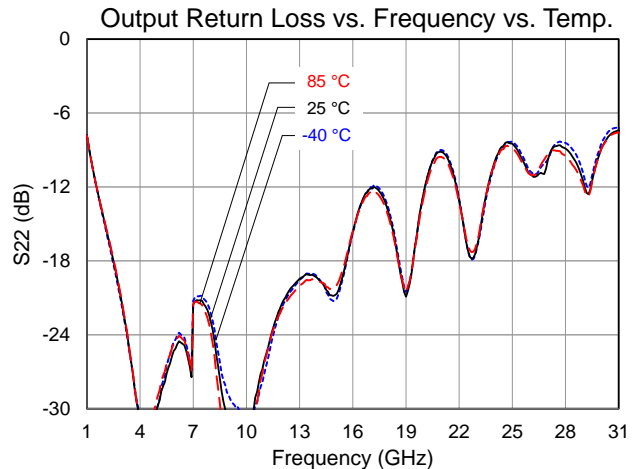
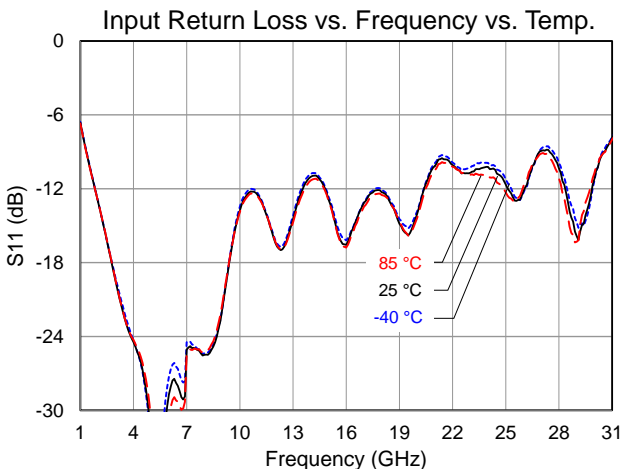
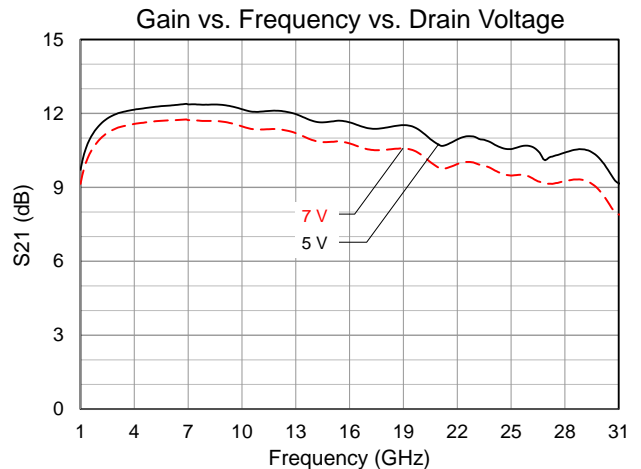
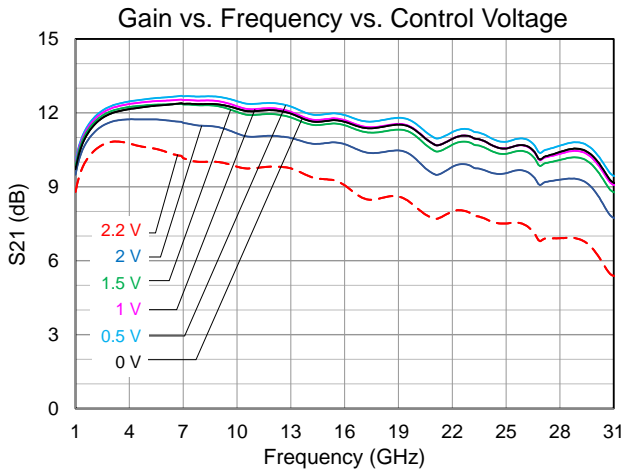
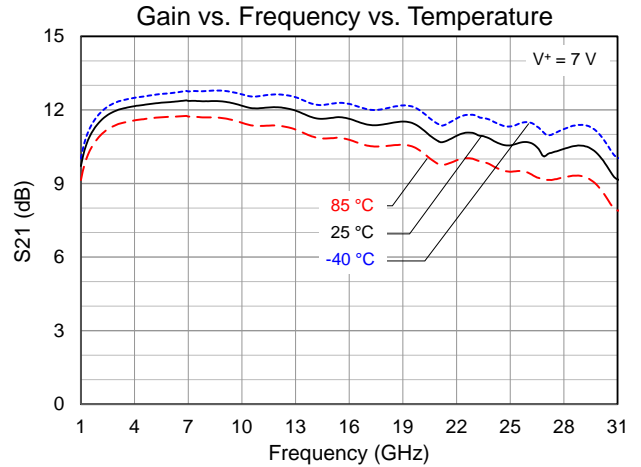
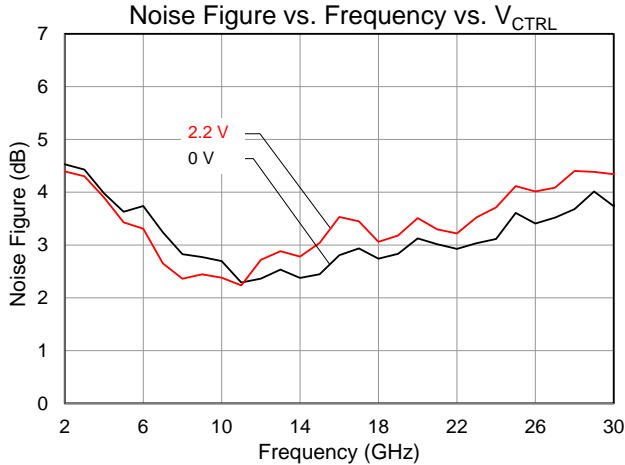

Typical Performance: Large Signal

Conditions unless otherwise specified: $V^+ = 5\text{ V}$, $I_{DQ} = 50\text{ mA}$, $V_{G1} = -1.5\text{ V}$ Typical, $V_{CTRL} = 0\text{ V}$, CW

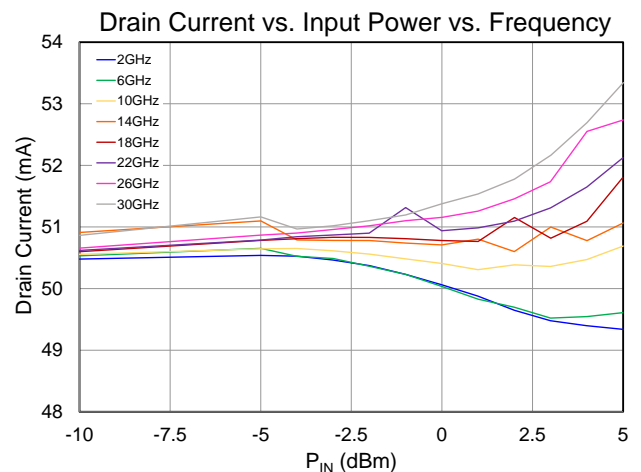
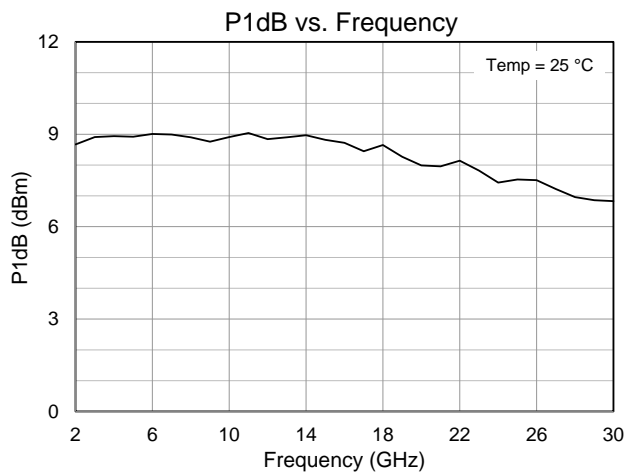
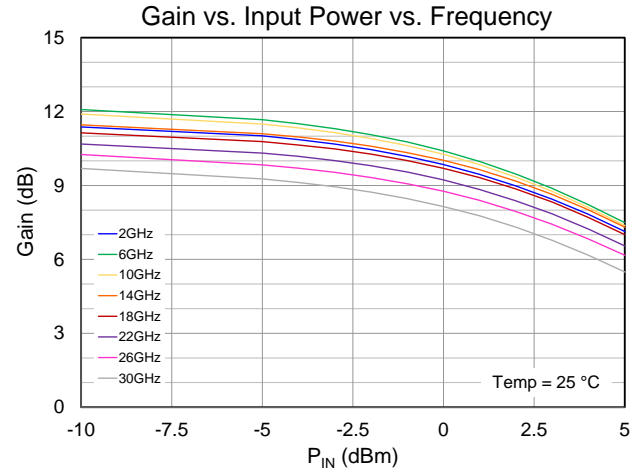
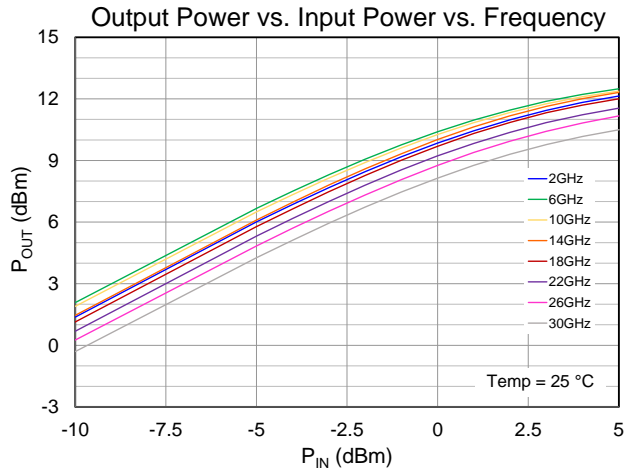

Typical Performance: Linearity

Conditions unless otherwise specified: $V^+ = 5\text{ V}$, $I_{DQ} = 50\text{ mA}$, $V_{G1} = -1.5\text{ V}$ Typical, $V_{CTRL} = 0\text{ V}$, CW

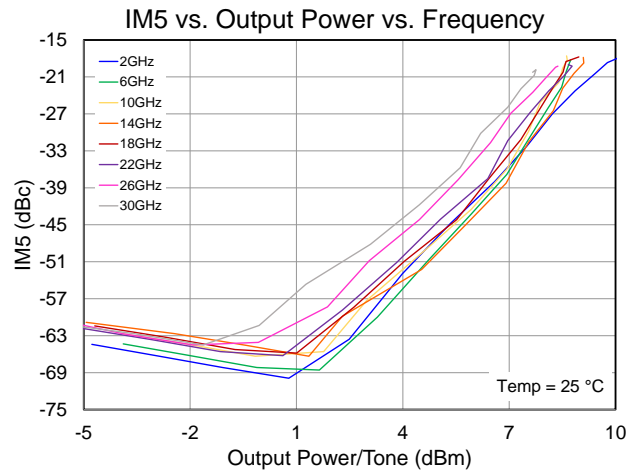
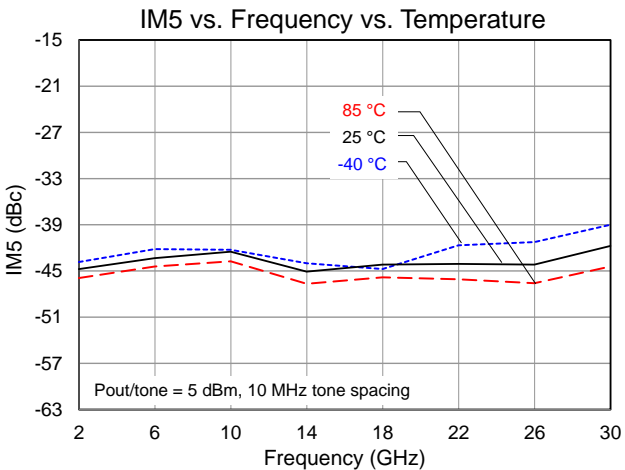
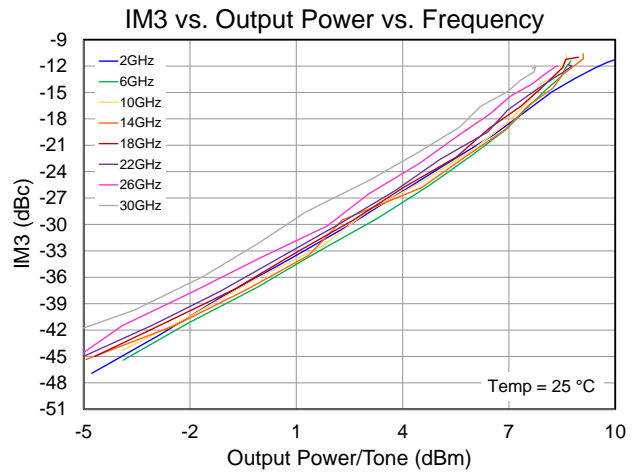
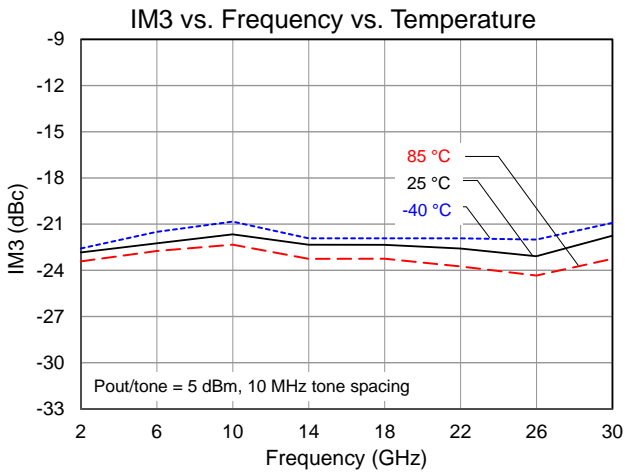
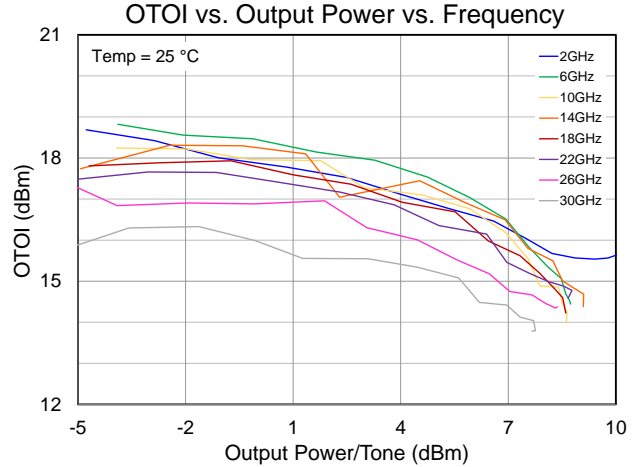
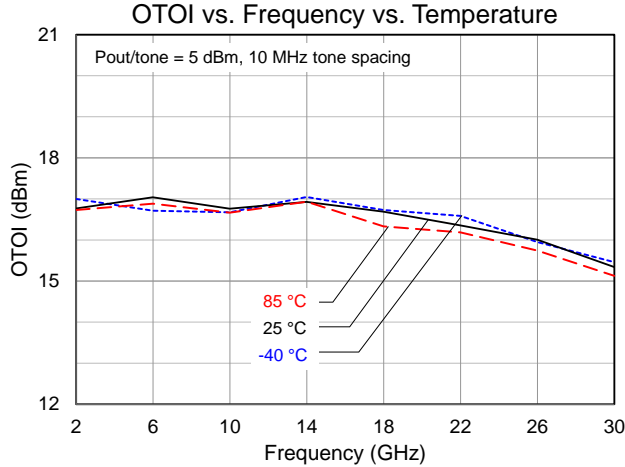

Application Information

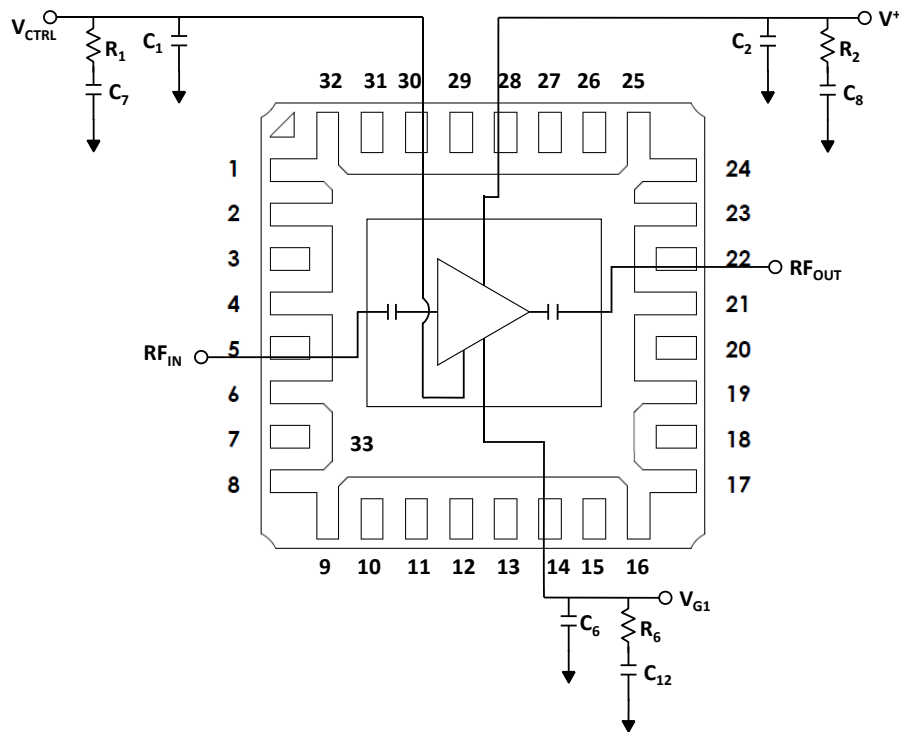

Bias-up Procedure

1. Set I_D limit to 72 mA, I_G limit to 10 mA
2. Apply -2 V to V_{G1} for pinch off
3. Apply desired value to V_{CTRL}
4. Apply +5 V to V_+ , resulting in $V_D = 3$ V
5. Adjust V_{G1} more positive until $I_{DQ} = 50$ mA ($V_G \sim -1.5$ V Typical)
6. Apply Gain Control signal (V_{CTRL})
7. Apply RF signal

Bias-down Procedure

1. Turn off RF signal
2. Reduce V_{G1} to -2 V. Ensure $I_{DQ} \sim 0$ mA
3. Set V_+ to 0 V
4. Turn off V_{CTRL} supply
5. Turn off V_D supply
6. Turn off V_{G1} supply

Pin Description

Pin No.	Symbol	Description
1-4, 6-13, 15-21, 23-27, 29, 31-32	Gnd	Recommend grounding on PCB
5	RF _{IN}	Input; matched to 50 Ω; DC blocked
14	V_{G1}	Gate voltage; bias network is required; see recommended Application Information above.
22	RF _{OUT}	Output; matched to 50 Ω; DC blocked
28	V_+	Drain voltage; bias network is required; see recommended Application Information above.
30	V_{CTRL}	Gain control voltage; bias network is required; see recommended Application Information above.

Evaluation Board

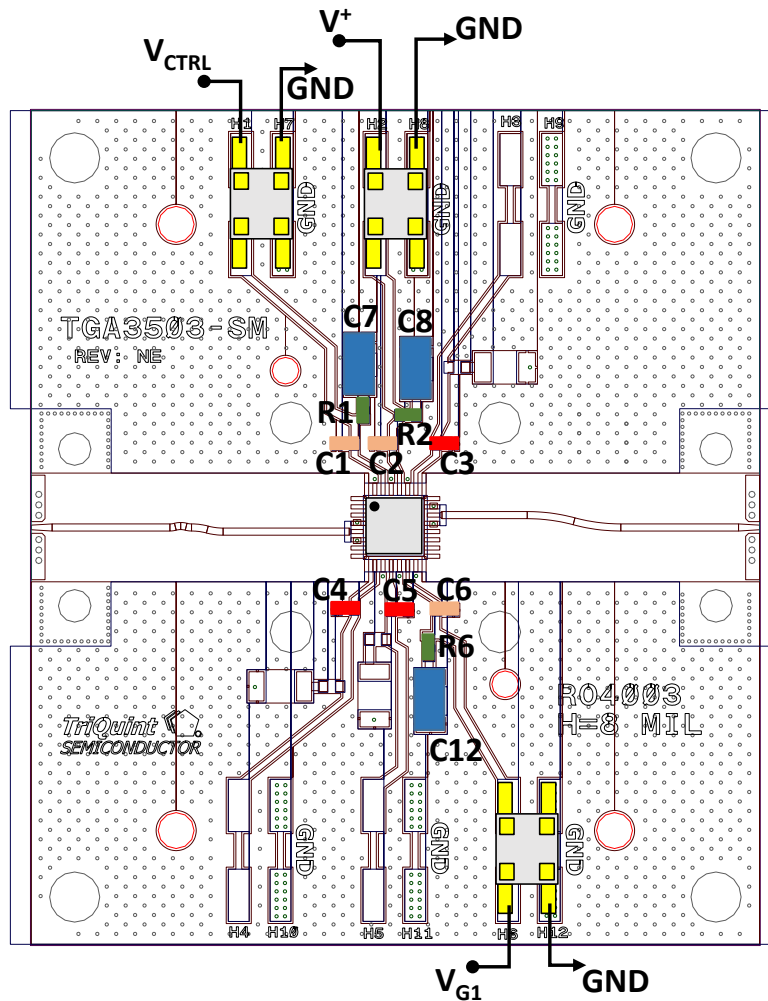

Bill of Material

Reference Des.	Value	Description	Manuf.	Part Number
C1, C2, C6	1 μ F	Cap, 0402, 50 V, 10%, X7R	Various	
C3, C4, C5	0 Ohms	Res, 0402, 5% (Required for above EVB design)	Various	
C7, C8, C12	2.2 μ F	Res, 1206, 50 V, 10%, X7R	Various	
R1, R2, R6	15 Ohms	Res, 0402, 50 V, 5%	Various	

Mechanical Information

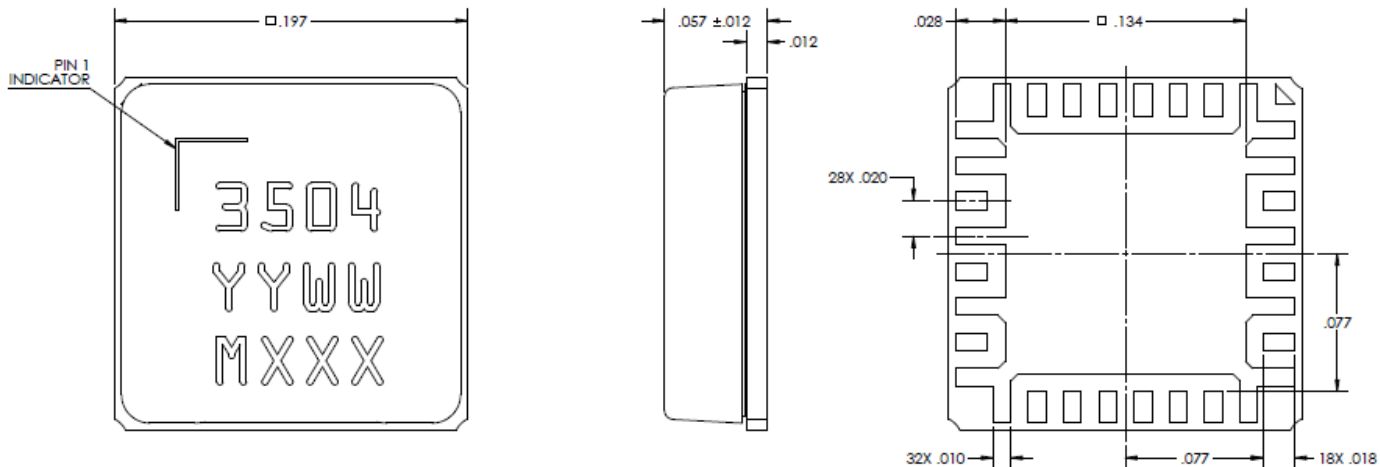

Units: inches

Tolerances: unless specified

x.xx = ± 0.01

x.xxx = ± 0.005

Materials:

Base: Aluminum Nitride

All metalized features are Au plated

Part is mold encapsulated

Marking:

3504: Part number

YY: Part Assembly year

WW: Part Assembly week

MXXX: Batch ID

Recommended Soldering Temperature Profile

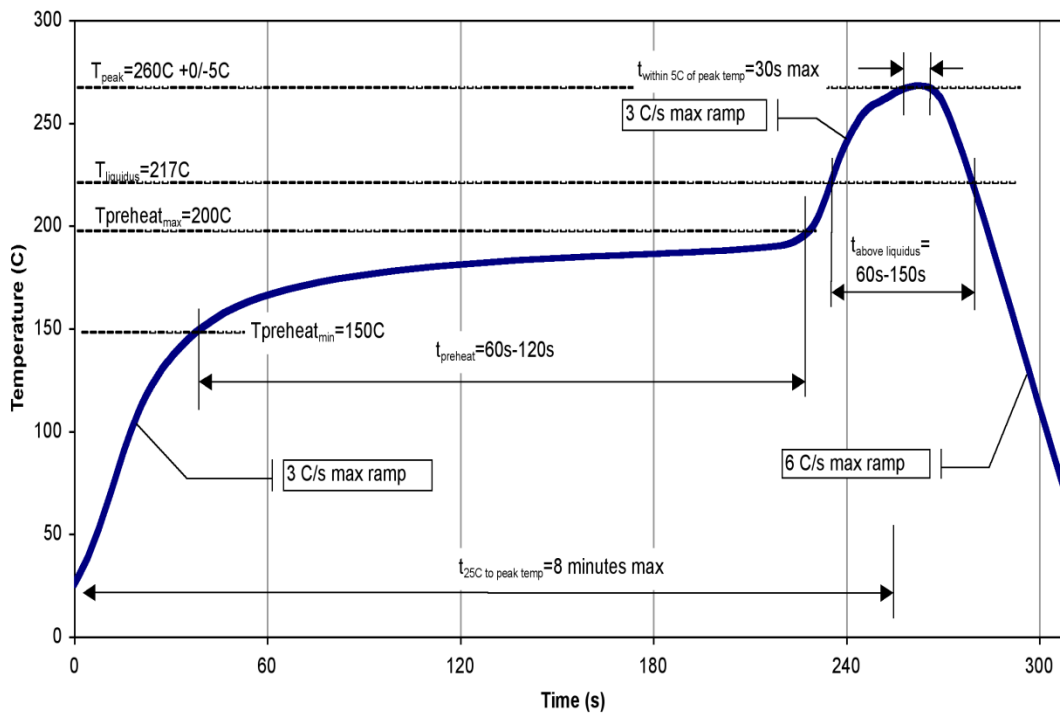

ESD Sensitivity Ratings



Caution! ESD-Sensitive Device

ESD Rating: TBD
Value: TBD
Test: Human Body Model (HBM)
Standard: JEDEC Standard JESD22-A114

MSL Rating

Level TBD at TBD°C convection reflow
The part is rated Moisture Sensitivity Level TBD at TBD°C per JEDEC standard IPC/JEDEC J-STD-020.

ECCN

US Department of Commerce: EAR99

Solderability

Compatible with the latest version of J-STD-020 Lead-free solder, 260 °C.

RoHS Compliance

This part is compliant with EU 2002/95/EC RoHS directive (Restrictions on the Use of Certain Hazardous Substances in Electrical and Electronic Equipment).

This product also has the following attributes:

- Lead Free
- Halogen Free (Chlorine, Bromine)
- Antimony Free
- TBBP-A (C₁₅H₁₂Br₄O₂) Free
- PFOS Free
- SVHC Free

Contact Information

For the latest specifications, additional product information, worldwide sales and distribution locations, and information about TriQuint:

Web: www.triquint.com
Email: info-sales@triquint.com

Tel: +1.972.994.8465
Fax: +1.972.994.8504

For technical questions and application information: Email: info-products@triquint.com

Important Notice

The information contained herein is believed to be reliable. TriQuint makes no warranties regarding the information contained herein. TriQuint assumes no responsibility or liability whatsoever for any of the information contained herein. TriQuint assumes no responsibility or liability whatsoever for the use of the information contained herein. The information contained herein is provided "AS IS, WHERE IS" and with all faults, and the entire risk associated with such information is entirely with the user. All information contained herein is subject to change without notice. Customers should obtain and verify the latest relevant information before placing orders for TriQuint products. The information contained herein or any use of such information does not grant, explicitly or implicitly, to any party any patent rights, licenses, or any other intellectual property rights, whether with regard to such information itself or anything described by such information.

TriQuint products are not warranted or authorized for use as critical components in medical, life-saving, or life-sustaining applications, or other applications where a failure would reasonably be expected to cause severe personal injury or death.



Компания «ЭлектроПласт» предлагает заключение долгосрочных отношений при поставках импортных электронных компонентов на взаимовыгодных условиях!

Наши преимущества:

- Оперативные поставки широкого спектра электронных компонентов отечественного и импортного производства напрямую от производителей и с крупнейших мировых складов;
- Поставка более 17-ти миллионов наименований электронных компонентов;
- Поставка сложных, дефицитных, либо снятых с производства позиций;
- Оперативные сроки поставки под заказ (от 5 рабочих дней);
- Экспресс доставка в любую точку России;
- Техническая поддержка проекта, помощь в подборе аналогов, поставка прототипов;
- Система менеджмента качества сертифицирована по Международному стандарту ISO 9001;
- Лицензия ФСБ на осуществление работ с использованием сведений, составляющих государственную тайну;
- Поставка специализированных компонентов (Xilinx, Altera, Analog Devices, Intersil, Interpoint, Microsemi, Aeroflex, Peregrine, Syfer, Eurofarad, Texas Instrument, Miteq, Cobham, E2V, MA-COM, Hittite, Mini-Circuits, General Dynamics и др.);

Помимо этого, одним из направлений компании «ЭлектроПласт» является направление «Источники питания». Мы предлагаем Вам помощь Конструкторского отдела:

- Подбор оптимального решения, техническое обоснование при выборе компонента;
- Подбор аналогов;
- Консультации по применению компонента;
- Поставка образцов и прототипов;
- Техническая поддержка проекта;
- Защита от снятия компонента с производства.



Как с нами связаться

Телефон: 8 (812) 309 58 32 (многоканальный)

Факс: 8 (812) 320-02-42

Электронная почта: org@eplast1.ru

Адрес: 198099, г. Санкт-Петербург, ул. Калинина, дом 2, корпус 4, литера А.