

**FEATURES****Driver**

- 3-level driver with high-Z mode and built-in clamps
- Precision trimmed output resistance
- Low leakage mode (typically <10 nA)
- Voltage range: -2.0 V to +6.0 V or -1.25 V to +6.75 V
- 2.4 ns minimum pulse width, 2 V terminated

Comparator

- Window and differential comparator
- 500 MHz input equivalent bandwidth

Load

- ±12 mA maximum current capability

Per pin PMU

- Force voltage range: -2.0 V to +6.0 V or -1.25 V to +6.75 V
- 5 current ranges: 32 mA, 2 mA, 200 μA, 20 μA, 2 μA

Levels

- 14-bit DAC for DCL levels
- Typically < ±5 mV INL (calibrated)
- 16-bit DAC for PMU levels
- Typically < ±1.5 mV INL (calibrated) linearity in FV mode

HVOUT output buffer

- 0 V to 13.5 V output range
- 84-lead, 9 mm × 9 mm, CSP_BGA package
- 900 mW per channel with no load

APPLICATIONS

- Automatic test equipment
- Semiconductor test systems
- Board test systems
- Instrumentation and characterization equipment

GENERAL DESCRIPTION

The [ADATE304](#) is a complete, single-chip solution that performs the pin electronic functions of the driver, the comparator, and the active load (DCL), per pin PMU, and dc levels for ATE applications. The device also contains an HVOUT driver with a VHH buffer capable of generating up to 13.5 V.

The driver features three active states: data high mode, data low mode, and term mode, as well as an inhibit state. The inhibit state, in conjunction with the integrated dynamic clamp, facilitates the implementation of a high speed active termination. The [ADATE304](#) supports two output voltage ranges: -2.0 V to +6.0 V and -1.25 V to +6.75 V by adjusting the positive and negative supply voltages.

Each channel of the [ADATE304](#) features a high speed window comparator per pin for functional testing, as well as a per pin PMU with FV, or FI and MV, or MI functions. All necessary dc levels for DCL functions are generated by on-chip 14-bit DACs. The per pin PMU features an on-chip 16-bit DAC for high accuracy and contains integrated range resistors to minimize external component counts.

The [ADATE304](#) uses a serial bus to program all functional blocks and has an on-board temperature sensor for monitoring the device temperature.

TABLE OF CONTENTS

Features	1	Thermal Resistance	19
Applications	1	Explanation of Test Levels	19
General Description	1	ESD Caution	19
Revision History	2	Pin Configuration and Function Descriptions	20
Functional Block Diagram	3	Typical Performance Characteristics	23
Specifications	4	SPI Details	33
Total Function	4	Definition of SPI Word	34
Driver	5	Write Operation	35
Reflection Clamp	7	Read Operation	36
Normal Window Comparator	7	Reset Operation	37
Differential Comparator	9	Register Map	38
Active Load	10	Details of Registers	39
PMU	11	User Information	41
External Sense (PMUS_CHx)	16	Power Supply Considerations	41
DUTGND Input	16	Truth Tables	41
Serial Peripheral Interface	16	Details of DACs vs. Levels	43
HVOUT Driver	17	Recommended PMU Mode Switching Sequences	45
Overvoltage Detector (OVD)	18	Block Diagrams	47
16-Bit DAC Monitor MUX	18	Outline Dimensions	51
Absolute Maximum Ratings	19	Ordering Guide	51

REVISION HISTORY

10/2017—Rev. B to Rev. C

Changes to Table 1	4
--------------------------	---

5/2017—Rev. A to Rev. B

Changes to Features Section	1
Changes to Table 1	4
Changes to Normal Window Comparator Section	7
Changes to Table 7	12

4/2017—Rev. 0 to Rev. A

Changes to Power Supplies Parameter, Table 1	4
--	---

10/2008—Revision 0: Initial Version

SPECIFICATIONS

Characterization and production tests performed using Power Supply Range 1 (see Table 37). $V_{DD} = +10.75\text{ V}$, $V_{CC} = +3.3\text{ V}$, $V_{SS} = -5.00\text{ V}$, $V_{PLUS} = +16.75\text{ V}$, $V_{COMP_VTT} = +3.3\text{ V}$, $V_{REF} = +5.0\text{ V}$, $V_{REF_GND} = 0.0\text{ V}$. All default test conditions are as defined in Table 38. All specified values are at $T_j = 55^\circ\text{C}$, where T_j corresponds to the internal temperature sensor and the temperature coefficients are measured at $T_j = 55^\circ\text{C} \pm 20^\circ\text{C}$, unless otherwise noted. Typical values are based on design, simulation analyses, and/or limited bench evaluations. Typical values are not tested or guaranteed. Test levels are specified in the Explanation of Test Levels section.

TOTAL FUNCTION

Table 1.

Parameter	Symbol	Min	Typ	Max	Unit	Test Level	Test Conditions/Comments
TOTAL FUNCTION							
Output Leakage Current PE Disable Range E		-20.0	+5.3	+20.0	nA	P	-1.25 V < V_{DUTX} < +6.75 V; PMU and PE disabled via SPI; PMU Range E, VCH = 7.5 V, VCL = -2.5 V
PE Disable Range A to Range D			5.3		nA	C _T	-1.25 V < V_{DUTX} < +6.75 V; PMU and PE disabled via SPI; PMU Range A, PMU Range B, PMU Range C, and PMU Range D, VCH = +7.5 V, VCL = -2.5 V
High-Z Mode		-400	+5.4	+400	nA	P	-1.25 V < V_{DUTX} < +6.75 V; PMU disabled and PE enabled via SPI; RCV active, VCH = +7.5 V, VCL = -2.5 V
Output Capacitance			4		pF	S	VTERM mode operation
DUT Pin Range		-1.25		+6.75	V	D	
POWER SUPPLIES							
Total Supply Range, V_{PLUS} to V_{SS}			22.5	23.25	V	D	Defines PSRR conditions
V_{PLUS} Supply	V_{PLUS}	16.25	16.75	17.25	V	D	Defines PSRR conditions
Positive Supply	V_{DD}	10.25	10.75	11.25	V	D	Defines PSRR conditions
Negative Supply	V_{SS}	-5.25	-5.00	-4.75	V	D	Defines PSRR conditions
Logic Supply	V_{CC}	3.1	3.3	3.5	V	D	Defines PSRR conditions
Comparator Termination	V_{COMP_VTT}	3.3		5.0	V	D	
V_{PLUS} Supply Current	I_{PLUS}	-1.0	+1.3	+3.0	mA	P	HVOUT disabled
		4.0	12.7	16.0	mA	P	HVOUT enabled, RCV active, no load, VHH = 12 V
Logic Supply Current	I_{CC}	1.0	2.7	4.0	mA	P	Quiescent (SPI is static)
Comparator Termination Current	I_{COMP_VTT}	10.0	17	26.0	mA	P	
Positive Supply Current	I_{DD}	72	94	101	mA	P	Load power down (IOH = IOL = 0 mA)
Negative Supply Current	I_{SS}	100	118	128	mA	P	Load power down (IOH = IOL = 0 mA)
Total Power Dissipation		1.0	1.68	1.87	W	P	Load power down (IOH = IOL = 0 mA)
Positive Supply Current	I_{DD}	102	134	156	mA	P	Load active off (IOH = IOL = 12 mA)
Negative Supply Current	I_{SS}	130	155	183	mA	P	Load active off (IOH = IOL = 12 mA)
Total Power Dissipation		1.8	2.3	2.55	W	P	Load active off (IOH = IOL = 12 mA)
TEMPERATURE MONITORS							
Temperature Sensor Gain			10		mV/K	C _T	
Temperature Sensor Accuracy Without Calibration over 25°C to 100°C			6		°C	C _T	Temperature voltage available on Pin A1 at all times and on Pin K1 (MEASOUT01/TEMPSENSE) when selected (see Table 24 and Table 36)
VREF INPUT							
Reference Input Voltage Range for DACs (VREF Pin)		4.95	5	5.05	V	D	Referenced to V_{REF_GND} ; not referenced to V_{DUTGND}
Input Bias Current			0.1	100	μA	P	Tested with 5 V applied

DRIVER

VH – VL ≥ 200 mV (to meet dc and ac specifications).

Table 2.

Parameter	Min	Typ	Max	Unit	Test Level	Test Conditions/Comments
DC SPECIFICATIONS						
High Speed Differential Logic Input Characteristics (DATAxx, RCVxx)						
Input Termination Resistance	92	100	108	Ω	P	Push 6 mA into xP pins ¹ , force 1.3 V on xN pins ¹ ; measure voltage from xP to xN ¹ , calculate resistance ($\Delta V/\Delta I$)
Input Voltage Differential	0.2		1.0	V	P _F	
Common-Mode Voltage	0.85		2.35	V	P _F	
	0.85		3.5	V	D	
Input Bias Current	-20.0	+2.2	+20.0	μA	P	Each pin tested at 2.85 V and 0.35 V while the other high speed pin remains open
Pin Output Characteristics						
Output High Range, VH	-1.15		+6.75	V	D	
Output Low Range, VL	-1.25		+6.65	V	D	
Output Term Range, VT	-1.25		+6.75	V	D	
Functional Amplitude (VH – VL)	0.0	8.0		V	D	Amplitude can be programmed to VH = VL, accuracy specifications apply when VH – VL ≥ 200 mV
DC Output Current Limit Source	75	100	120	mA	P	Driver high, VH = 6.75 V, short DUTx pin to -1.25 V, measure current
DC Output Current Limit Sink	-120	-100	-75	mA	P	Driver low, VL = -1.25 V, short DUTx pin to +6.75 V, measure current
Output Resistance, ±50 mA	45.0	47.0	49.0	Ω	P	Source: driver high, VH = +3.0 V, I _{DUTx} = +1 mA and +50 mA; sink: driver low, VL = 0.0 V, I _{DUTx} = -1 mA and -50 mA; $\Delta V_{DUT}/\Delta I_{DUT}$
ABSOLUTE ACCURACY						
VH, VL, VT Uncalibrated Accuracy	-250	±75	+250	mV	P	VH tests done with VL = -2.5 V and VT = -2.5 V; VL tests done with VH = +7.5 V and VT = +7.5 V; VT tests done with VL = -2.5 V and VH = +7.5 V; unless otherwise specified
VH, VL, VT Offset Tempco		±450		μV/°C	C _T	Error measured at calibration points of 0 V and 5 V
VH, VL, VT DNL		±1		mV	C _T	Measured at calibration points
VH, VL, VT INL	-10	±2.5	+10	mV	P	After two-point gain/offset calibration
VH, VL, VT Resolution		0.6	+1	mV	P _F	After two-point gain/offset calibration; measured over driver output ranges
DUTGND Voltage Accuracy	-7	±1.3	+7	mV	P	After two-point gain/offset calibration; range/number of DAC bits as measured at calibration points of 0 V and 5 V
VH, VL, VT Crosstalk		±2		mV	C _T	Over ±0.1 V range; measured at endpoints of VH, VL, and VT functional range
Overall Voltage Accuracy		±10		mV	C _T	VL = -1.25 V: VH = -1.15 V → +6.75 V, VT = -1.25 V → +6.75 V; VH = +6.75 V: VL = -1.25 V → +6.65 V, VT = -1.25 V → +6.75 V; VT = +1.25 V: VL = -1.25 V → +6.65 V, VH = -1.15 V → +6.75 V; dc crosstalk on VL, VH, VT output level when other driver DACs are varied
VH, VL, VT DC PSRR		±15		mV/V	C _T	Sum of INL, crosstalk, DUTGND, and tempco over ±5°C, after gain/offset calibration
AC SPECIFICATIONS						
Rise/Fall Times						Toggle DATAxx
0.2 V Programmed Swing		950		ps	C _B	VH = 0.2 V, VL = 0.0 V, terminated; 20% to 80%
1.0 V Programmed Swing		850		ps	C _B	VH = 1.0 V, VL = 0.0 V, terminated; 20% to 80%
2.0 V Programmed Swing	850	1150	1350	ps	C _B	VH = 3.0 V, VL = 0.0 V, terminated; 20% to 80%
3.0 V Programmed Swing		1500		ps	P/C _B	VH = 3.0 V, VL = 0.0 V, terminated; 20% to 80%
3.0 V Programmed Swing		2000		ps	C _B	VH = 3.0 V, VL = 0.0 V, unterminated; 10% to 90%
5.0 V Programmed Swing		3100		ps	C _B	VH = 5.0V, VL = 0.0 V, unterminated; 10% to 90%
Rise-to-Fall Matching		40		ps	C _B	VH = 3.0 V, VL = 0.0 V, terminated; rise-to-fall within one channel

Parameter	Min	Typ	Max	Unit	Test Level	Test Conditions/Comments
Minimum Pulse Width						Toggle DATAxx
1.0 V Programmed Swing		1.7		ns	C _B	VH = 1.0 V, VL = 0.0 V, terminated; timing error ± 75 ps
		1.7		ns	C _B	VH = 1.0 V, VL = 0.0 V, terminated; less than 10% amplitude degradation
2.0 V Programmed Swing		2.0		ns	C _B	VH = 2.0 V, VL = 0.0 V, terminated; timing error ± 75 ps
		2.2		ns	C _B	VH = 2.0 V, VL = 0.0 V, terminated; less than 10% amplitude degradation
3.0 V Programmed Swing		2.7		ns	C _B	VH = 3.0 V, VL = 0.0 V, terminated; timing error ± 75 ps
		2.7		ns	C _B	VH = 3.0 V, VL = 0.0 V, terminated; less than 10% amplitude degradation
Maximum Toggle Rate						
2.0 V Programmed Swing		200		MHz	C _B	VH = 2.0 V, VL = 0.0 V, terminated, 10% amplitude degradation
Dynamic Performance, Drive (VH to VL and VL to VH)						Toggle DATAxx
Propagation Delay Time		3.0		ns	C _B	VH = 2.0 V, VL = 0.0 V, terminated
Propagation Delay Tempco		3.0		ps/°C	C _T	VH = 2.0 V, VL = 0.0 V, terminated
Delay Matching						VH = 2.0 V, VL = 0.0 V, terminated
Edge to Edge		80		ps	C _B	Rising vs. falling
Channel to Channel		30		ps	C _B	Rising vs. rising, falling vs. falling
Delay Change vs. Duty Cycle		30		ps	C _B	VH = 3.0 V, VL = 0.0 V, terminated; 5% to 95% duty cycle; 1 MHz
Overshoot and Undershoot		30		mV	C _B	VH = 3.0 V, VL = 0.0 V, terminated
Settling Time (VH to VL)						Toggle DATAxx
To Within 3% of Final Value		4		ns	C _B	VH = 3.0 V, VL = 0.0 V, terminated
To Within 1% of Final Value		25		ns	C _B	VH = 3.0 V, VL = 0.0 V, terminated
Dynamic Performance, VT (VH or VL to VT and VT to VH or VL)						Toggle RCVxx
Propagation Delay Time		3.7		ns	C _B	VH = 3.0 V, VT = 1.5 V, VL = 0.0 V, terminated
Delay Matching, Edge to Edge		150		ps	C _B	VH = 3.0 V, VT = 1.5 V, VL = 0.0 V, terminated; rising vs. falling
Propagation Delay Tempco		4.0		ps/°C	C _T	VH = 3.0 V, VT = 1.5 V, VL = 0.0 V, terminated
Transition Time, Active to VT and VT to Active		1.0		ns	C _B	VH = 3.0 V, VT = 1.5 V, VL = 0.0 V, terminated; 20% to 80%
Dynamic Performance, Inhibit (VH or VL to/from Inhibit)						Toggle RCVxx
Propagation Delay Time						VH = +1.0 V, VL = -1.0 V, terminated
Active to Inhibit		4.5		ns	C _B	
Inhibit to Active		7.9		ns	C _B	
Transition Time						VH = +1.0 V, VL = -1.0 V, terminated; 20% to 80%
Active to Inhibit		2.9		ns	C _B	
Inhibit to Active		0.65		ns	C _B	
I/O Spike		190		mV	C _B	VH = 0.0 V, VL = 0.0 V, terminated

¹ The xP pins include DATA0P, DATA1P, RCV0P, and RCV1P; the xN pins include DATA0N, DATA1N, RCV0N, and RCV1N. For example, push 6 mA into the DATA0P pin, force 1.3 V into DATA0N, and measure the voltage from DATA0P to DATA0N.

REFLECTION CLAMPClamp accuracy specifications apply when $V_{CH} > V_{CL}$.**Table 3.**

Parameter	Min	Typ	Max	Unit	Test Level	Test Conditions/Comments
VCH						
Range	-1.0		+6.75	V	D	
Uncalibrated Accuracy	-200	±50	+200	mV	P	Driver high-Z, sinking 1 mA; VCH error measured at the calibration points of 0.0 V and 5.0 V
Resolution		0.6	0.75	mV	P _F	Driver high-Z, sinking 1 mA; after two-point gain/offset calibration; range/number of DAC bits as measured at the calibration points of 0.0 V and 5.0 V
DNL		±1		mV	C _T	Driver high-Z, sinking 1 mA; after two-point gain/offset calibration
INL	-40	±2	+40	mV	P	Driver high-Z, sinking 1 mA; after two-point gain/offset calibration; measured over VCH range of -1.0 V to +6.75 V
Tempco		-0.3		mV/°C	C _T	Measured at calibration points
VCL						
Range	-1.25		+5.75	V	D	
Uncalibrated Accuracy	-200	±50	+200	mV	P	Driver high-Z, sourcing 1 mA; VCL error measured at the calibration points of 0.0 V and 5.0 V
Resolution		0.6	0.75	mV	P _F	Driver high-Z, sourcing 1 mA; after two-point gain/offset calibration; range/number of DAC bits as measured at the calibration points of 0.0 V and 5.0 V
DNL		±1		mV	C _T	Driver high-Z, sourcing 1 mA; after two-point gain/offset calibration
INL	-40	±2	+40	mV	P	Driver high-Z, sourcing 1 mA; after two-point gain/offset calibration; measured over VCL range of -1.0 V to +5.75 V
Tempco		0.5		mV/°C	C _T	Measured at calibration points
DC CLAMP CURRENT LIMIT						
VCH	-120	-85	-60	mA	P	Driver high-Z, VCH = 0 V, VCL = -1.0 V, V _{DUTx} = +5 V
VCL	60	85	120	mA	P	Driver high-Z, VCH = 6.75 V, VCL = 5.0 V, V _{DUTx} = 0.0 V
DUTGND VOLTAGE ACCURACY						
	-7	±1	+7	mV	P	Over ±0.1 V range; measured at the endpoints of VCH and VCL functional range

NORMAL WINDOW COMPARATOR

VOH tests done with VOL = -1.25 V; VOL tests done with VOH = +6.75 V, unless otherwise specified.

Table 4.

Parameter	Min	Typ	Max	Unit	Test Level	Test Conditions/Comments
DC SPECIFICATIONS						
Input Voltage Range	-1.25		+6.75	V	D	
Differential Voltage Range	±0.1		±8.0	V	D	
Comparator Input Offset Voltage Accuracy, Uncalibrated	-150	±30	+150	mV	P	Offset measured at the calibration points of 0.0 V and 5.0 V
Comparator Threshold Resolution		0.6	1	mV	P _F	After two-point gain/offset calibration; range/number of DAC bits as measured at the calibration points of 0 V and 5 V
Comparator Threshold DNL		±1		mV	C _T	After two-point gain/offset calibration
Comparator Threshold INL	-7	±1.3	+7	mV	P	After two-point gain/offset calibration; measured over VOH, VOL range of -1.25 V to +6.75 V
Comparator Input Offset Voltage Tempco		±100		μV/°C	C _T	Measured at calibration points
DUTGND Voltage Accuracy	-7	±0.5	+7	mV	P	Over ±0.1 V range; measured at endpoints of VOH and VOL functional range

Parameter	Min	Typ	Max	Unit	Test Level	Test Conditions/Comments
Comparator Uncertainty Range		6.0		mV	C _B	V _{DUTx} = 0 V, sweep comparator threshold to determine uncertainty region
DC Hysteresis		0.5		mV	C _B	V _{DUTx} = 0 V
DC PSRR		±5		mV/V	C _T	Measured at calibration points
Digital Output Characteristics						
Internal Pull-Up Resistance to Comparator, COMP_VTT Pin	40	50	60	Ω	P	Pull 1 mA and 10 mA from Logic 1 leg and measure ΔV to calculate resistance; measured ΔV/9 mA; done for both comparator logic states
V _{COMP_VTT} Range	3.3		5.0	V	D	
Common-Mode Voltage		V _{COMP_VTT} - 1.88		V	C _T	Measured with 100 Ω differential termination
	V _{COMP_VTT} - 2.075		V _{COMP_VTT} - 1.675	V	P	Measured with no external termination
Differential Voltage		250		mV	C _T	Measured with 100 Ω differential termination
	400	500	600	mV	P	Measured with no external termination
Rise/Fall Time, 20% to 80%		450		ps	C _B	Measured with each comparator leg terminated 50 Ω to GND
AC SPECIFICATIONS						Input transition time = 800 ps, 10% to 90%; measured with each comparator leg terminated 50 Ω to GND, unless otherwise specified
Propagation Delay, Input to Output		1.75		ns	C _B	V _{DUTx} = 0 V to 1.0 V swing, Driver VTERM mode, VT = 0.0 V; high-side measurement: VOH = +0.50 V, VOL = -1.25 V; low-side measurement: VOH = +6.75 V, VOL = +0.50 V
Propagation Delay Tempco		5		ps/°C	C _T	V _{DUTx} = 0 V to 1.0 V swing, Driver VTERM mode, VT = 0.0 V; high-side measurement: VOH = +0.50 V, VOL = -1.25 V; low-side measurement: VOH = +6.75 V, VOL = +0.50 V
Propagation Delay Matching						V _{DUTx} = 0 V to 1.0 V swing, Driver VTERM mode, VT = 0.0 V; high-side measurement: VOH = +0.50 V, VOL = -1.25 V; low-side measurement: VOH = +6.75 V, VOL = +0.50 V
High Transition to Low Transition		200		ps	C _B	
High to Low Comparator		50		ps	C _B	
Propagation Delay Change (with Respect To)						
Slew Rate, 800 ps, 1 ns, 1.2 ns, and 2.2 ns (10% to 90%)		50		ps	C _B	V _{DUTx} = 0 V to 1.0 V swing, Driver VTERM mode, VT = 0.0 V; high-side measurement: VOH = +0.50 V, VOL = -1.25 V; low-side measurement: VOH = +6.75 V, VOL = +0.50 V
Overdrive, 250 mV and 1.0 V		75		ps	C _B	For 250 mV: V _{DUTx} = 0 V to 0.5 V swing; for 1.0 V: V _{DUTx} = 0 V to 1.25 V swing; Driver VTERM mode, VT = 0.0 V; high-side measurement: VOH = +0.25 V, VOL = -1.25 V; low-side measurement: VOH = +6.75 V, VOL = +0.25 V
Pulse Width, Sweep 1.6 ns to 10 ns		75		ps	C _B	V _{DUTx} = 0 V to 1.0 V swing @ 32.0 MHz, Driver VTERM mode, VT = 0.0 V; high-side measurement: VOH = +0.5 V, VOL = -1.25 V; low-side measurement: VOH = +6.75 V, VOL = +0.5 V
Duty Cycle, 5% to 95%		50		ps	C _B	V _{DUTx} = 0 V to 1.0 V swing @ 1.0 MHz, Driver VTERM mode, VT = 0.0 V; high-side measurement: VOH = +0.50 V, VOL = -1.25 V; low-side measurement: VOH = +6.75 V, VOL = +0.50 V
Minimum Pulse Width		2.0		ns	C _B	V _{DUTx} = 0 V to 1.0 V swing, Driver VTERM mode, VT = 0.0 V; less than 12% amplitude degradation measured by shmoo
Input Equivalent Bandwidth, Terminated		500		MHz	C _B	V _{DUTx} = 0 V to 1.0 V swing, Driver VTERM mode, VT = 0.0 V; as measured by shmoo
ERT High-Z Mode, 3 V, 20% to 80%		2.5		ns	C _B	V _{DUTx} = 0 V to 3.0 V swing, driver high-Z; as measured by shmoo; input transition time of ~2000 ps, 10% to 90%

DIFFERENTIAL COMPARATOR

VOH tests done with VOL = -1.1 V, VOL tests done with VOH = +1.1 V, unless otherwise specified.

Table 5.

Parameter	Min	Typ	Max	Unit	Test Level	Test Conditions/Comments
DC SPECIFICATIONS						
Input Voltage Range	-1.25		+4.5	V	D	
Operational Differential Voltage Range	±0.05		±1.1	V	D	
Maximum Differential Voltage Range			±8	V	D	
Comparator Input Offset Voltage Accuracy, Uncalibrated	-150	±35	+150	mV	P/C _T	Offset measured at differential calibration points +1.0 V and -1.0 V, with common mode = 0.0 V
VOH, VOL Resolution		0.6	1	mV	P _F	After two-point gain/offset calibration; range/number of DAC bits as measured at differential calibration points +1.0 V and -1.0 V, with common mode = 0.0 V
VOH, VOL DNL		±1		mV	C _T	After two-point gain/offset calibration; common mode = 0.0 V
VOH, VOL INL	-15	±2.0	+15	mV	P	After two-point gain/offset calibration; measured over VOH, VOL range of -1.1 V to +1.1 V, common mode = 0.0 V
VOH, VOL Offset Voltage Tempco		±200		μV/°C	C _T	Measured at calibration points
Comparator Uncertainty Range		18		mV	C _B	V _{DUTX} = 0 V, sweep comparator threshold to determine uncertainty region
DC Hysteresis		0.5		mV	C _B	V _{DUTX} = 0 V
CMRR		0.15	1	mV/V	P	Offset measured at common-mode voltage points of -1.5 V and +4.5 V, with differential voltage = 0.0 V
DC PSRR		±1.5		mV/V	C _T	Measured at calibration points
AC SPECIFICATIONS						
Propagation Delay, Input to Output		1.7		ns	C _B	Input transition time = 800 ps, 10% to 90%, measured with each comparator leg terminated 50 Ω to GND V _{DUT0} = 0 V, V _{DUT1} = -0.5 V to +0.5 V swing, Driver VTERM mode, VT = 0.0 V; high-side measurement: VOH = 0.0 V, VOL = -1.1 V; low-side measurement: VOH = +1.1 V, VOL = 0.0 V; repeat for other DUT channel
Propagation Delay Tempco		5		ps/°C	C _T	V _{DUT0} = 0 V, V _{DUT1} = -0.5 V to +0.5 V swing, Driver VTERM mode, VT = 0.0 V; high-side measurement: VOH = 0.0 V, VOL = -1.1 V; low-side measurement: VOH = +1.1 V, VOL = 0.0 V; repeat for other DUT channel
Propagation Delay Matching						V _{DUT0} = 0 V, V _{DUT1} = -0.5 V to +0.5 V swing, Driver VTERM mode, VT = 0.0 V; high-side measurement: VOH = 0.0 V, VOL = -1.1 V; low-side measurement: VOH = +1.1 V, VOL = 0.0 V; repeat for other DUT channel
High Transition to Low Transition High-to-Low Comparator		100		ps	C _B	
Propagation Delay Change (with Respect To)		50		ps	C _B	
Slew Rate, 800 ps, 1 ns, 1.2 ns, and 2.2 ns (10% to 90%)		60		ps	C _B	V _{DUT0} = 0 V, V _{DUT1} = -0.5 V to +0.5 V swing, Driver VTERM mode, VT = 0.0 V; high-side measurement: VOH = 0.0 V, VOL = -1.1 V; low-side measurement: VOH = +1.1 V, VOL = 0.0 V; repeat for other DUT channel
Overdrive, 250 mV and 750 mV		100		ps	C _B	V _{DUT0} = 0 V, for 250 mV: V _{DUT1} = 0 V to 0.5 V swing; for 750 mV: V _{DUT1} = 0 V to 1.0 V swing, Driver VTERM mode, VT = 0.0 V; VOH = -0.25 V; repeat for other DUT channel with comparator threshold = +0.25 V
Pulse Width, Sweep from 1.6 ns to 10 ns		75		ps	C _B	V _{DUT0} = 0 V, V _{DUT1} = -0.5 V to +0.5 V swing @ 32 MHz, Driver VTERM mode, VT = 0.0 V; high-side measurement: VOH = 0.0 V, VOL = -1.1 V; low-side measurement: VOH = +1.1 V, VOL = 0.0 V; repeat for other DUT channel
Duty Cycle, 5% to 95%		60		ps	C _B	V _{DUT0} = 0 V, V _{DUT1} = -0.5 V to +0.5 V swing @ 1 MHz, Driver VTERM mode, VT = 0.0 V; high-side measurement: VOH = 0.0 V, VOL = -1.1 V; low-side measurement: VOH = +1.1 V, VOL = 0.0 V; repeat for other DUT channel

Parameter	Min	Typ	Max	Unit	Test Level	Test Conditions/Comments
Minimum Pulse Width		2.5		ns	C _B	V _{DUT0} = 0 V, V _{DUT1} = -0.5 V to +0.5 V swing, Driver VTERM mode, VT = 0.0 V; high-side measurement: VOH = 0.0 V, VOL = -1.1 V; low-side measurement: VOH = +1.1 V, VOL = 0.0 V; less than 10% amplitude degradation measured by shmoo; repeat for other DUT channel
Input Equivalent Bandwidth, Terminated		400		MHz	C _B	V _{DUT0} = 0 V, V _{DUT1} = -0.5 V to +0.5 V swing, Driver VTERM mode, VT = 0.0 V; high-side measurement: VOH = 0.0 V, VOL = -1.1 V; low-side measurement: VOH = +1.1 V, VOL = 0.0 V; less than 22% amplitude degradation measured by shmoo; repeat for other DUT channel

ACTIVE LOAD

See the Truth Tables section and Table 29 for load control information.

Table 6.

Parameter	Min	Typ	Max	Unit	Test Level	Test Conditions/Comments
DC SPECIFICATIONS						
Load active on, RCV active, unless otherwise noted						
Input Characteristics						
VCOM Voltage Range	-1.00		+6.50	V	D	
V _{DUT} Range	-1.25		+6.75	V	D	
VCOM Accuracy, Uncalibrated	-200	±30	+200	mV	P	IOH = IOL = 6 mA, VCOM error measured at the calibration points of 0.0 V and 5.0 V
VCOM Resolution		0.6	1	mV	P _F	IOH = IOL = 6 mA, after two-point gain/offset calibration; range/number of DAC bits as measured at the calibration points of 0.0 V and 5.0 V
VCOM DNL		±1		mV	C _T	IOH = IOL = 6 mA, after two-point gain/offset calibration
VCOM INL	-7	±2	+7	mV	P	IOH = IOL = 6 mA, after two-point gain/offset calibration; measured over VCOM range of -1.00 V to +6.50 V
DUTGND Voltage Accuracy	-7	±1	+7	mV	P	Over ±0.1 V range; measured at end points of VCOM functional range
Output Characteristics						
IOL						
Maximum Source Current	12			mA	D	
Uncalibrated Offset	-600	±100	+600	µA	P	IOH = 0 mA, VCOM = 1.5 V, V _{DUTx} = 0.0 V, IOL offset calculated from the calibration points of 1 mA and 11 mA
Uncalibrated Gain	-12	±4	+12	%	P	IOH = 0 mA, VCOM = 1.5 V, V _{DUTx} = 0.0 V, IOL gain calculated from the calibration points of 1 mA and 11 mA
Resolution		1.5	2	µA	P _F	IOH = 0 mA, VCOM = 1.5 V, V _{DUTx} = 0.0 V, after two-point gain/offset calibration; range/number of DAC bits as measured at the calibration points of 1 mA and 11 mA
DNL		±3.0		µA	C _T	IOH = 0 mA, VCOM = 1.5 V, V _{DUTx} = 0.0 V, after two-point gain/offset calibration
INL	-80	±20	+80	µA	P	IOH = 0 mA, VCOM = 1.5 V, V _{DUTx} = 0.0 V, after two-point gain/offset calibration; measured over IOL range of 0 mA to 12 mA
90% Commutation Voltage			0.25	V	P	IOH = IOL = 12 mA, VCOM = 2.0 V, measure IOL reference at V _{DUTx} = -1.0 V, measure IOL current at V _{DUTx} = +1.75 V, ensure > 90% of reference current
IOH						
Maximum Sink Current	12			mA	D	
Uncalibrated Offset	-600	±100	+600	µA	P	IOL = 0 mA, VCOM = 1.5 V, V _{DUTx} = 3.0 V, IOH offset calculated from the calibration points of 1 mA and 11 mA
Uncalibrated Gain	-12	±4	+12	%	P	IOL = 0 mA, VCOM = 1.5 V, V _{DUTx} = 3.0 V, IOH gain calculated from the calibration points of 1 mA and 11 mA
Resolution		1.5	2	µA	P _F	IOL = 0 mA, VCOM = 1.5 V, V _{DUTx} = 3.0 V, after two-point gain/offset calibration; range/number of DAC bits as measured at the calibration points of 1 mA and 11 mA
DNL		±3.0		µA	C _T	IOL = 0 mA, VCOM = 1.5 V, V _{DUTx} = 3.0 V, after two-point gain/offset calibration

Parameter	Min	Typ	Max	Unit	Test Level	Test Conditions/Comments
INL	-80	±20	+80	µA	P	IOL = 0 mA, VCOM = 1.5 V, V _{DUTx} = 3.0 V, after two-point gain/offset calibration; measured over IOH range of 0 mA to 12 mA
90% Commutation Voltage			0.25	V	P	IOH = IOL = 12 mA, VCOM = 2.0 V, measure IOH reference at V _{DUTx} = 5.0 V, measure IOH current at V _{DUTx} = 2.25 V, ensure > 90% of reference current
Output Current Tempco		±1.5		µA/°C	C _T	Measured at calibration points
AC SPECIFICATIONS						Load active on, unless otherwise noted
Dynamic Performance						
Propagation Delay, Load Active Off to Load Active On; 50%,90%		7.3		ns	C _B	Toggle RCV, DUTx terminated 50 Ω to GND, IOH = IOL = 12 mA, VH = VL = 0 V, VCOM = +1.25 V for IOL and VCOM = -1.25 V for IOH; measured from 50% point of RCVxP – RCVxN to 90% point of final output, repeat for drive low and high
Propagation Delay, Load Active Off to Load Active On; 50%, 90%		10.3		ns	C _B	Toggle RCV, DUTx terminated 50 Ω to GND, IOH = IOL = 12 mA, VH = VL = 0 V, VCOM = +1.25 V for IOL and VCOM = -1.25 V for IOH; measured from 50% point of RCVxP – RCVxN to 90% point of final output, repeat for drive low and high
Propagation Delay Matching		3.0		ns	C _B	Toggle RCV, DUTx terminated 50 Ω to GND, IOH = IOL = 12 mA, VH = VL = 0 V, VCOM = +1.25 V for IOL and VCOM = -1.25 V for IOH; active on vs. active off, repeat for drive low and high
Load Spike		190		mV	C _B	Toggle RCV, DUTx terminated 50 Ω to GND, IOH = IOL = 0 mA, VH = VL = 0 V, VCOM = +1.25 V for IOL and VCOM = -1.25 V for IOH; repeat for drive low and high
Settling Time to 90%		1.9		ns	C _B	Toggle RCV, DUTx terminated 50 Ω to GND, IOH = IOL = 12 mA, VH = VL = 0 V, VCOM = +1.25 V for IOL and VCOM = -1.25 V for IOH; measured at 90% of final value

PMU

FV is the force voltage, MV is the measure voltage, FI is the force current, MI is the measure current, FN is force nothing.

Table 7.

Parameter	Min	Typ	Max	Unit	Test Level	Test Conditions/Comments
FORCE VOLTAGE (FV)						
Current Range A	±32			mA	D	
Current Range B	±2			mA	D	
Current Range C	±200			µA	D	
Current Range D	±20			µA	D	
Current Range E	±2			µA	D	
Force Input Voltage Range at Output for All Ranges	-1.25		+6.75	V	D	
Force Voltage Uncalibrated Accuracy for Range C	-100	±25	+100	mV	P	PMU enabled, FV, Range C, PE disabled, error measured at calibration points of 0.0 V and 5.0 V
Force Voltage Uncalibrated Accuracy for All Ranges		±25		mV	C _T	PMU enabled, FV, PE disabled, error measured at calibration points of 0.0 V and 5.0 V; repeat for each PMU current range
Force Voltage Offset Tempco for All Ranges		±25		µV/°C	C _T	Measured at calibration points for each PMU current range
Force Voltage Gain Tempco for All Ranges		±10		ppm/°C	C _T	Measured at calibration points for each PMU current range
Forced Voltage INL	-7	±2	+7	mV	P	PMU enabled, FV, Range C, PE disabled, after two-point gain/offset calibration; measured over output range of -1.25 V to +6.75 V
Force Voltage Compliance vs. Current Load						PMU enabled, FV, PE disabled, force -1.25 V, measure voltage while PMU sinking zero and full-scale current; measure ΔV; force 6.75 V, measure voltage while PMU sourcing zero and full-scale current; measure ΔV; repeat for each PMU current range
Range A		±4		mV	C _T	
Range B to Range E		±1		mV	C _T	

Parameter	Min	Typ	Max	Unit	Test Level	Test Conditions/Comments
Current Limit, Source, and Sink Range A	108	140	180	%FS	P	PMU enabled, FV, PE disabled; sink: force 2.5 V, short DUTx to 6.0 V; source: force 2.5 V, short DUTx to -1.0 V; Range A FS = 32 mA, 108% FS = 35 mA, 180% FS = 58 mA
Range B to Range E	120	145	180	%FS	P	PMU enabled, FV, PE disabled; sink: force 2.5 V, short DUTx to 6.0 V; source: force 2.5 V, short DUTx to -1.0 V; repeat for each PMU current range; example: Range B FS = 2 mA, 120 % FS = 2.4 mA, 180% FS = 3.6 mA
DUTGND Voltage Accuracy	-7	±1	+7	mV	P	Over ±0.1 V range; measured at endpoints of FV functional range
MEASURE CURRENT (MI)						
Measure Current, Pin DUTx Voltage Range for All Ranges	-1.25		+6.75	V	D	V_{DUTx} externally forced to 0.0V, unless otherwise specified; ideal MEASOUT transfer functions: $V_{MEASOUT01} [V] = (I_{MEASOUT01} \times 5/FSR) + 2.5 + V_{DUTGND}$ $I(V_{MEASOUT01}) [A] = (V_{MEASOUT01} - V_{DUTGND} - 2.5) \times FSR/5$
Measure Current Uncalibrated Accuracy Range A		±500		µA	C _T	PMU enabled, FIMI, Range A, PE disabled, error at calibration points -25 mA and +25 mA, error = $(I(V_{MEASOUT01}) - I_{DUTx})$
Range B	-400	±3.0	+400	µA	P	PMU enabled, FIMI, Range B, PE disabled, error at calibration points -1.6 mA and +1.6 mA, error = $(I(V_{MEASOUT01}) - I_{DUTx})$
Range C		± 2.00		µA	C _T	PMU enabled, FIMI, PE disabled, error at calibration points of ±80% FS, error = $(I(V_{MEASOUT01})_1 - I_{DUTx})$
Range D		±0.30		µA	C _T	PMU enabled, FIMI, PE disabled, error at calibration points of ±80% FS, error = $(I(V_{MEASOUT01}) - I_{DUTx})$
Range E		±0.08		µA	C _T	PMU enabled, FIMI, PE disabled, error at calibration points of ±80% FS, error = $(I(V_{MEASOUT01}) - I_{DUTx})$
Measure Current Offset Tempco Range A		±2		µA/°C	C _T	Measured at calibration points
Range B		±25		nA/°C	C _T	Measured at calibration points
Range C		±5		nA/°C	C _T	Measured at calibration points
Range D and Range E		±1		nA/°C	C _T	Measured at calibration points
Measure Current Gain Error, Nominal Gain = 1 Range A		±2.5		%	C _T	PMU enabled, FIMI, PE disabled, gain error from calibration points ±80% FS
Range B	-20	±2	+20	%	P	PMU enabled, FIMI, Range B, PE disabled, gain error from calibration points ±1.6 mA
Range C to Range E		±4		%	C _T	PMU enabled, FIMI, PE disabled, gain error from calibration points ±80% FS
Measure Current Gain Tempco Range A		±300		ppm/°C	C _T	Measured at calibration points
Range B to Range E		±50		ppm/°C	C _T	Measured at calibration points
Measure Current INL Range A		±0.05		%FSR	C _T	PMU enabled, FIMI, Range A, PE disabled, after two-point gain/offset calibration, measured over FSR output of -32 mA to +32 mA
Range B	-0.02		+0.02	%FSR	P	PMU enabled, FIMI, Range B, PE disabled, after two-point gain/offset calibration measured over FSR output of -2 mA to +2 mA
Range B to Range E		±0.01		%FSR	C _T	PMU enabled, FIMI, PE disabled, after two-point gain/offset calibration; measured over FSR output
FVMI DUT Pin Voltage Rejection	-0.01		+0.01	%FSR/V	P	PMU enabled, FVMI, Range B, PE disabled, force -1 V and +5 V into load of 1 mA; measure ΔI reported at MEASOUT01
DUTGND Voltage Accuracy		±2.5		mV	C _T	Over ±0.1 V range; measured at endpoints of MI functional range

Parameter	Min	Typ	Max	Unit	Test Level	Test Conditions/Comments
FORCE CURRENT (FI)						V_{DUTx} externally forced to 0.0V, unless otherwise specified, ideal force current transfer function: $I_{FORCE} = (PMUDAC - 2.5) \times (FSR/5)$
Force Current, DUTx Pin Voltage Range for All Ranges	-1.25		+6.75	V	D	
Force Current Uncalibrated Accuracy						
Range A	-5.0	±0.5	+5.0	mA	P	PMU enabled, FIMI, Range A, PE disabled, error at calibration points of -25 mA and +25 mA
Range B	-400	±40	+400	µA	P	PMU enabled, FIMI, Range B, PE disabled, error at calibration points of -1.6 mA and 1.6 mA
Range C	-40	±4	+40	µA	P	PMU enabled, FIMI, Range C, PE disabled, error at calibration points of ±80% FS
Range D	-4	±0.4	+4	µA	P	PMU enabled, FIMI, Range D, PE disabled, error at calibration points of ±80% FS
Range E	-400	±75	+400	nA	P	PMU enabled, FIMI, Range E, PE disabled, error at calibration points of ±80% FS
Force Current Offset Tempco						
Range A		±1		µA/°C	C _T	Measured at calibration points
Range B		±80		nA/°C	C _T	Measured at calibration points
Range C to Range E		±4		nA/°C	C _T	Measured at calibration points
Forced Current Gain Error, Nominal Gain = 1	-20	±4	+20	%	P	PMU enabled, FIMI, PE disabled, gain error from calibration points of ±80% FS
Forced Current Gain Tempco						Measured at calibration points
Range A		-500		ppm/°C	C _T	
Range B to Range E		±75		ppm/°C	C _T	
Force Current INL						
Range A	-0.3	±0.05	+0.3	%FSR	P	PMU enabled, FIMI, Range A, PE disabled, after two-point gain/offset calibration; measured over FSR output of -32 mA to +32 mA
Range B to Range E	-0.2	±0.015	+0.2	%FSR	P	PMU enabled, FIMI, PE disabled, after two-point gain/offset calibration; measured over FSR output
Force Current Compliance vs. Voltage Load						PMU enabled, FIMV, PE disabled; force positive full-scale current driving -1.25 V and +6.75 V, measure ΔI @ DUTx pin; force negative full-scale current driving -1.25 V and +6.75 V, measure ΔI @ DUTx pin
Range A to Range D	-0.6	±0.06	+0.6	%FSR	P	
Range E	-1.0	±0.1	+1.0	%FSR	P	
MEASURE VOLTAGE						
Measure Voltage Range	-1.25		+6.75	V	D	
Measure Voltage Uncalibrated Accuracy	-25	±2.0	+25	mV	P	PMU enabled, FVMV, Range B, PE disabled, error at calibration points of 0 V and 5 V, error = $(V_{MEASOUT01} - V_{DUTx})$
Measure Voltage Offset Tempco		±10		µV/°C	C _T	Measured at calibration points
Measure Voltage Gain Error	-0.2	±0.01	+0.2	%	P	PMU enabled, FVMV, Range B, PE disabled, gain error from calibration points of 0 V and 5 V
Measure Voltage Gain Tempco		25		ppm/°C	C _T	Measured at calibration points
Measure Voltage INL	-7	±1	+7	mV	P	PMU enabled, FVMV, Range B, PE disabled, after two-point gain/offset calibration; measured over output range of -1.25 V to +6.75 V
Rejection of Measure V vs. I_{DUTx}	-1.5	±0.1	+1.5	mV	P	PMU enabled, FVMV, Range D, PE disabled, force 0 V into load of -10 µA and +10 µA; measure ΔV reported at MEASOUT01

Parameter	Min	Typ	Max	Unit	Test Level	Test Conditions/Comments
MEASOUT01 DC CHARACTERISTICS						
MEASOUT01 Voltage Range	-1.25		+6.75	V	D	PMU enabled, FVMV, PE disabled; source resistance: PMU force +6.75 V and load with 0 mA and +4 mA; sink resistance: PMU force -1.25 V and load with 0 mA and -4 mA; resistance = $\Delta V/\Delta I$ at MEASOUT01 pin Tested at -1.25 V and +6.75 V PMU enabled, FVMV, PE disabled; source: PMU force +6.75 V, short MEASOUT01 to -1.25 V; sink: PMU force -1.25 V, short MEASOUT01 to +6.75 V
DC Output Current			4	mA	D	
MEASOUT01 Pin Output Impedance		25	200	Ω	P	
Output Leakage Current when Tristated	-1		+1	μ A	P	
Output Short-Circuit Current	-25		+25	mA	P	
VOLTAGE CLAMPS						
Low Clamp Range (VCL)	-1.25		+4.75	V	D	PMU enabled, FIMI, Range A, PE disabled, PMU clamps enabled, VCH = +5.0 V, VCL = -1.0 V, PMU force 2.0 mA and 32 mA into open; ΔV seen at DUTx pin PMU enabled, FIMI, Range A, PE disabled, PMU clamps enabled, VCH = +5.0 V, VCL = -1.0 V, PMU force -2.0 mA and -32 mA into open; ΔV seen at DUTx pin PMU enabled, FIMI, Range B, PE disabled, PMU clamps enabled, PMU force ± 1 mA into open; VCH errors at calibration points 1.0 V and 5.0 V; VCL errors at the calibration points 0.0 V and 4.0 V PMU enabled, FIMI, Range B, PE disabled, PMU clamps enabled, PMU force ± 1 mA into open; after two-point gain/offset calibration; measured over PMU clamp range Over ± 0.1 V range; measured at endpoints of PMU clamp functional range
High Clamp Range (VCH)	0.75		6.75	V	D	
Positive Clamp Voltage Droop	-300	+10	+300	mV	P	
Negative Clamp Voltage Droop	-300	-10	+300	mV	P	
Uncalibrated Accuracy	-250	± 100	+250	mV	P	
INL	-70	± 5	+70	mV	P	
DUTGND Voltage Accuracy		± 1		mV	C _T	
SETTLING/SWITCHING TIMES						
Voltage Force Settling Time to 0.1% of Final Value						SCAP = 330 pF, FFCAP = 220 pF PMU enabled, FV, PE disabled, program PMUDAC steps of 500 mV and 5.0 V; simulation of worst case, 2000 pF load, PMUDAC step of 5.0 V
Range A, 200 pF and 2000 pF Load		15		μ s	S	PMU enabled, FV, PE disabled, start with PMUDAC programmed to 0.0 V, program PMUDAC to 500 mV
Range B, 200 pF and 2000 pF Load		20		μ s	S	
Range C, 200 pF and 2000 pF Load		124		μ s	S	
Range D, 200 pF and 2000 pF Load		1015		μ s	S	
Range E, 200 pF and 2000 pF Load		3455		μ s	S	
Voltage Force Settling Time to 1.0% of Final Value						
Range A, 200 pF and 2000 pF Load		14		μ s	C _B	
Range B, 200 pF and 2000 pF Load		14		μ s	C _B	
Range C, 200 pF and 2000 pF Load		14		μ s	C _B	
Range D, 200 pF Load		45		μ s	C _B	
Range D, 2000 pF Load		45		μ s	C _B	
Range E, 200 pF Load		45		μ s	C _B	
Range E, 2000 pF Load		225		μ s	C _B	

Parameter	Min	Typ	Max	Unit	Test Level	Test Conditions/Comments
Voltage Force Settling Time to 1.0% of Final Value						PMU enabled, FV, PE disabled, start with PMUDAC programmed to 0.0 V, program PMUDAC to 5.0 V
Range A, 200 pF and 2000 pF Load		4.0		μs	C _B	
Range B, 200 pF Load		4.2		μs	C _B	
Range B, 2000 pF Load		4.2		μs	C _B	
Range C, 200 pF Load		5.8		μs	C _B	
Range C, 2000 pF Load		19		μs	C _B	
Range D, 200 pF Load		50		μs	C _B	
Range D, 2000 pF Load		210		μs	C _B	
Range E, 200 pF Load		360		μs	C _B	
Range E, 2000 pF Load		610		μs	C _B	
Current Force Settling Time to 0.1% of Final Value						PMU enabled, FI, PE disabled, start with PMUDAC programmed to 0 current, program PMUDAC to FS current
Range A, 200 pF in Parallel with 120 Ω		8.2		μs	S	
Range B, 200 pF in Parallel with 1.5 kΩ		9.4		μs	S	
Range C, 200 pF in Parallel with 15.0 kΩ		30		μs	S	
Range D, 200 pF in Parallel with 150 kΩ		281		μs	S	
Range E, 200 pF in Parallel with 1.5 MΩ		2668		μs	S	
Current Force Settling Time to 1.0% of Final Value						PMU enabled, FI, PE disabled, start with PMUDAC programmed to 0 current, program PMUDAC to FS current
Range A, 200 pF in Parallel with 120 Ω		4.2		μs	C _B	
Range B, 200 pF in Parallel with 1.5 kΩ		4.3		μs	C _B	
Range C, 200 pF in Parallel with 15.0 kΩ		8.1		μs	C _B	
Range D, 200 pF in Parallel with 150 kΩ		205		μs	C _B	
Range E, 200 pF in Parallel with 1.5 MΩ		505		μs	C _B	
INTERACTION AND CROSSTALK						
Measure Voltage Channel-to-Channel Crosstalk		±0.125		%FSR	C _T	PMU enabled, FIMV, PE disabled, Range B, forcing 0 mA into 0 V load; other channel: Range A, forcing a step of 0 mA to 25 mA into 0 V load; report ΔV of MEASOUT01 pin under test; 0.125% × 8.0 V = 10 mV
Measure Current Channel-to-Channel Crosstalk		±0.01		%FSR	C _T	PMU enabled, FVMI, PE disabled, Range E, forcing 0 V into 0 mA current load; other channel: Range E, forcing a step of 0 V to 5 V into 0 mA current load; report ΔV of MEASOUT01 pin under test; 0.01% × 5.0 V = 0.5 mV

EXTERNAL SENSE (PMUS_CHx)

Table 8.

Parameter	Min	Typ	Max	Unit	Test Level	Test Conditions/Comments
EXTERNAL SENSE (PMUS_CHX)						
Voltage Range	-1.25		+6.75	V	D	Tested at -1.25 V and +6.75 V
Input Leakage Current	-20		+20	nA	P	

DUTGND INPUT

Table 9.

Parameter	Min	Typ	Max	Unit	Test Level	Test Conditions/Comments
DUTGND INPUT						
Input Voltage Range, Referenced to GND	-0.1		+0.1	V	D	Tested at -100 mV and +100 mV
Input Bias Current		1	100	μA	P	

SERIAL PERIPHERAL INTERFACE

Table 10.

Parameter	Min	Typ	Max	Unit	Test Level	Test Conditions/Comments
SERIAL PERIPHERAL INTERFACE						
Serial Input Logic High	1.8		V _{CC}	V	P _F	Tested at 0.0 V and 3.3 V
Serial Input Logic Low	0		0.7	V	P _F	
Input Bias Current	-10	1	+10	μA	P	PE disabled, PMU FV enabled and forcing 0 V
SCLK Clock Rate		50		MHz	P _F	
SCLK Pulse Width		9		ns	C _T	Sourcing 2 mA
SCLK Crosstalk on DUTx Pin		8		mV	C _B	
Serial Output Logic High	V _{CC} - 0.4		V _{CC}	V	P _F	Sinking 2 mA Maximum delay time required for the part to enter a stable state after a serial bus
Serial Output Logic Low	0		0.8	V	P _F	
Update Time		10		μs	D	

HVOUT DRIVER

Table 11.

Parameter	Min	Typ	Max	Unit	Test Level	Test Conditions/Comments
VHH BUFFER						VHH = (VT + 1 V) × 2 + DUTGND
Voltage Range	5.9		V _{PLUS} – 3.25	V	D	V _{PLUS} = 16.75 V nominal; in this condition, V _{HVOUT} max = 13.5 V
Output High	13.5			V	P	VHH mode enabled, RCV active, VHH level = full scale, sourcing 15 mA
Output Low			5.9	V	P	VHH mode enabled, RCV active, VHH level = zero scale, sinking 15 mA
Accuracy Uncalibrated	–500	±100	+500	mV	P	VHH mode enabled, RCV active, V _{HVOUT} error measured at the calibration points of 7 V and 12 V
Offset Tempco		1		mV/°C	C _T	Measured at calibration points
Resolution		1.21	1.5	mV	P _F	VHH mode enabled, RCV active, after two-point gain/offset calibration; range/number of DAC bits as measured at the calibration points of 7 V and 12 V
INL	–30	±15	+30	mV	P	VHH mode enabled, RCV active, after two-point gain/offset calibration; measured over VHH range of 5.9 V to 13.5 V
DUTGND Voltage Accuracy		±1		mV	C _T	Over ±0.1 V range; measured at endpoints of VHH functional range
Output Resistance		1	10	Ω	P	VHH mode enabled, RCV active, source: VHH = 10.0 V, I _{HVOUT} = 0 mA and 15 mA; sink: VHH = 6.5 V, I _{HVOUT} = 0 mA and –15 mA; ΔV/ΔI
DC Output Current Limit Source	60		100	mA	P	VHH mode enabled, RCV active, VHH = 10.0 V, short HVOUT pin to 5.9 V, measure current
DC Output Current Limit Sink	–100		–60	mA	P	VHH mode enabled, RCV active, VHH = 6.5 V, short HVOUT pin to 14.1 V, measure current
Rise Time (From VL or VH to VHH)		200		ns	C _B	VHH mode enabled, toggle RCV, VHH = 13.5 V, VL = VH = 3.0 V; 20% to 80%, for DATA = high and DATA = low
Fall Time (From VHH to VL or VH)		26		ns	C _B	VHH mode enabled, toggle RCV, VHH = 13.5 V, VL = VH = 3.0 V; 20% to 80%, for DATA = high and DATA = low
Preshoot, Overshoot, and Undershoot		±125		mV	C _B	VHH mode enabled, toggle RCV, VHH = 13.5 V, VL = VH = 3.0 V; for DATA = high and DATA = low
VL/VH BUFFER						
Voltage Range	–0.1		+6.0	V	D	
Accuracy Uncalibrated	–500	±100	+500	mV	P	VHH mode enabled, RCV inactive, error measured at the calibration points 0 V and 5 V
Offset Tempco		1		mV/°C	C _T	Measured at calibration points
Resolution		0.61	0.75	mV	P _F	VHH mode enabled, RCV inactive, after two-point gain/offset calibration; range/number of DAC bits as measured at the calibration points 0 V and 5 V
INL	–20	±4	+20	mV	P	VHH mode enabled, RCV inactive, after two-point gain/offset calibration; measured over range of –0.1 V to +6.0 V
DUTGND Voltage Accuracy		±2		mV	C _T	Over ±0.1 V range; measured at endpoints of VH and VL, functional range
Output Resistance	45	48	50	Ω	P	VHH mode enabled, RCV inactive, source: VH = 3.0 V, I _{HVOUT} = +1 mA and +50 mA; sink: VL = 2.0 V, I _{HVOUT} = –1 mA and –50 mA; ΔV/ΔI
DC Output Current Limit Source	60		100	mA	P	VHH mode enabled, RCV inactive, VH = +6.0 V, short HVOUT pin to –0.1 V, DATA high, measure current
DC Output Current Limit Sink	–100		–60	mA	P	VHH mode enabled, RCV inactive, VL = –0.1 V, short HVOUT pin to +6.0 V, DATA low, measure current
Rise Time (VL to VH)		11		ns	C _B	VHH mode enabled, RCV inactive, VL = 0.0 V, VH = 3.0 V, toggle DATA; 20% to 80%
Fall Time (VH to VL)		11.3		ns	C _B	VHH mode enabled, RCV inactive, VL = 0.0 V, VH = 3.0 V, toggle DATA; 20% to 80%
Preshoot, Overshoot, and Undershoot		±54		mV	C _B	VHH mode enabled, RCV inactive, VL = 0.0 V, VH = 3.0 V, toggle DATA

OVERVOLTAGE DETECTOR (OVD)

Table 12.

Parameter	Min	Typ	Max	Unit	Test Level	Test Conditions/Comments
DC CHARACTERISTICS						
Programmable Voltage Range	-2.25		+7.0	V	D	OVD offset errors measured at programmed levels of +7.0 V and -2.25 V
Accuracy Uncalibrated	-200		+200	mV	P	
Hysteresis		112		mV	C _B	
LOGIC OUTPUT CHARACTERISTICS						
Off State Leakage		10	1000	nA	P	Disable OVD alarm, apply 3.3 V to OVD pin, measure leakage current
Maximum On Voltage @ 100 μA		0.2	0.7	V	P	Activate alarm, force 100 μA into OVD pin, measure active alarm voltage
Propagation Delay		1.9		μs	C _B	For OVD high: DUTx = 0 V to +6 V swing, OVD high = +3.0 V, OVD low = -2.25 V; for OVD low: DUTx = 0 V to +6 V swing, OVD high = +7.0 V, OVD low = +3.0 V

16-BIT DAC MONITOR MUX

Table 13.

Parameter	Min	Typ	Max	Unit	Test Level	Test Conditions/Comments
DC CHARACTERISTICS						
Programmable Voltage Range	-2.5		+7.5	V	D	PMUDAC = 0.0 V, FV, I = 0, 200 μA; ΔV/ΔI
Output Resistance		16		kΩ	C _T	

ABSOLUTE MAXIMUM RATINGS

Table 14.

Parameter	Rating
Supply Voltages	
Positive Supply Voltage (V_{DD} to GND)	-0.5 V to +11.5 V
Positive V_{CC} Supply Voltage (V_{CC} to GND)	-0.5 V to +4.0 V
Negative Supply Voltage (V_{SS} to GND)	-6.25 V to +0.5 V
Supply Voltage Difference (V_{DD} to V_{SS})	-1.0 V to +16.5 V
Reference Ground (DUTGND to GND)	-0.5 V to +0.5 V
AGND to DGND	-0.5 V to +0.5 V
VPLUS Supply Voltage (V_{PLUS} to GND)	-0.5 V to +17.5 V
Input Voltages	
Input Common-Mode Voltage	V_{SS} to V_{DD}
Short-Circuit Voltage ¹	-3.0 V to +8.0 V
High Speed Input Voltage ²	0.0 V to V_{CC}
High Speed Differential Input Voltage ³	0.0 V to V_{CC}
VREF	-0.5 V to +5.5 V
DUTx I/O Pin Current	
DCL Maximum Short-Circuit Current ⁴	±140 mA
Temperature	
Operating Temperature, Junction	125°C
Storage Temperature Range	-65°C to +150°C

¹ $R_L = 0 \Omega$, V_{DUT} continuous short-circuit condition (V_H , V_L , V_T , high-Z, V_{COM} , clamp modes).

² DATAxP, DATAxN, RCVxP, RCVxN, under source $R_L = 0 \Omega$.

³ DATAxP to DATAxN, RCVxP, RCVxN.

⁴ $R_L = 0 \Omega$, $V_{DUTx} = -3 \text{ V to } +8 \text{ V}$; DCL current limit. Continuous short-circuit condition. [ADATE304](#) must current limit and survive continuous short circuit.

Stresses at or above those listed under Absolute Maximum Ratings may cause permanent damage to the product. This is a stress rating only; functional operation of the product at these or any other conditions above those indicated in the operational section of this specification is not implied. Operation beyond the maximum operating conditions for extended periods may affect product reliability.

THERMAL RESISTANCE

Table 15. Thermal Resistance

Package Type	θ_{JA}	θ_{JC}
84-Ball CSP_BGA	31.1	0.51

EXPLANATION OF TEST LEVELS

D	Definition
S	Design verification simulation
P	100% production tested
P _F	Functionally checked during production test
C _T	Characterized on tester
C _B	Characterized on bench

ESD CAUTION



ESD (electrostatic discharge) sensitive device. Charged devices and circuit boards can discharge without detection. Although this product features patented or proprietary protection circuitry, damage may occur on devices subjected to high energy ESD. Therefore, proper ESD precautions should be taken to avoid performance degradation or loss of functionality.

PIN CONFIGURATION AND FUNCTION DESCRIPTIONS

	10	9	8	7	6	5	4	3	2	1
A	HVOUT	PMUS_CH0	VSSO_0 (DRIVE)	DUT0	VDDO_0 (DRIVE)	VDDO_1 (DRIVE)	DUT1	VSSO_1 (DRIVE)	PMUS_CH1	TEMPSENSE
B	VPLUS	SCAP0	VSS	AGND	VDD	VDD	AGND	VSS	SCAP1	VDD/VDD-TMPSNS
C	FFCAP_0B	AGND	DATA0N	VSS	VDD	VDD	VSS	DATA1N	AGND	FFCAP_1B
D	OVD_CH0	VDD	DATA0P					DATA1P	VDD	OVD_CH1
E	FFCAP_0A	VSS	RCV0N					RCV1N	VSS	FFCAP_1A
F	AGND	AGND	RCV0P					RCV1P	AGND	AGND
G	COMP_QL0P	COMP_QL0N	COMP_VTT0					COMP_VTT1	COMP_QL1N	COMP_QL1P
H	COMP_QH0P	COMP_QH0N	AGND	VSS	VDD	VDD	VSS	AGND	COMP_QH1N	COMP_QH1P
J	AGND	AGND	AGND	RST	SDIN	DGND	DAC16_MON	AGND	AGND	AGND
K	VREF_GND	VREF	AGND	VCC	SCLK	SDOUT	CS	AGND	DUTGND	MEASOUT01/TEMPSENSE

07279-902

Figure 2. Pin Configuration

Table 16. Pin Function Descriptions

Pin No.	Mnemonic	Description
A1	TEMPSENSE	Temperature Sense Output
A2	PMUS_CH1	PMU External Sense Path Channel 1
A3	VSSO_1 (Drive)	Driver Output Supply (–5.0 V) Channel 1
A4	DUT1	Device Under Test Channel 1
A5	VDDO_1 (Drive)	Driver Output Supply (+10.75 V) Channel 1
A6	VDDO_0 (Drive)	Driver Output Supply (+10.75 V) Channel 0
A7	DUT0	Device Under Test Channel 0
A8	VSSO_0 (Drive)	Driver Output Supply (–5.0 V) Channel 0
A9	PMUS_CH0	PMU External Sense Path Channel 0
A10	HVOUT	High Voltage Driver Output
B1	VDD/VDD_TMPSNS	Temperature Sense Supply (+10.75 V)
B2	SCAP1	PMU Stability Capacitor Connection Channel 1 (330 pF)
B3	VSS	Supply (–5.0 V)
B4	AGND	Analog Ground
B5	VDD	Supply (+10.75 V)
B6	VDD	Supply (+10.75 V)
B7	AGND	Analog Ground
B8	VSS	Supply (–5.0 V)
B9	SCAP0	PMU Stability Capacitor Connection Channel 0 (330 pF)
B10	VPLUS	Supply (+16.75 V)
C1	FFCAP_1B	PMU Feedforward Capacitor Connection B Channel 1 (220 pF)
C2	AGND	Analog Ground
C3	DATA1N	Driver Data Input (Negative) Channel 1
C4	VSS	Supply (–5.0 V)
C5	VDD	Supply (+10.75 V)
C6	VDD	Supply (+10.75 V)
C7	VSS	Supply (–5.0 V)
C8	DATA0N	Driver Data Input (Negative) Channel 0
C9	AGND	Analog Ground
C10	FFCAP_0B	PMU Feedforward Capacitor Connection B Channel 0 (220 pF)
D1	OVD_CH1	Overvoltage Detection Flag Output Channel 1
D2	VDD	Supply (+10.75 V)
D3	DATA1P	Driver Data Input (Positive) Channel 1
D8	DATA0P	Driver Data Input (Positive) Channel 0
D9	VDD	Supply (+10.75 V)
D10	OVD_CH0	Overvoltage Detection Flag Output Channel 0
E1	FFCAP_1A	PMU Feedforward Capacitor Connection A Channel 1 (220 pF)
E2	VSS	Supply (–5.0 V)
E3	RCV1N	Receive Data Input (Negative) Channel 1
E8	RCV0N	Receive Data Input (Negative) Channel 0
E9	VSS	Supply (–5.0 V)
E10	FFCAP_0A	PMU Feedforward Capacitor Connection A Channel 0 (220 pF)
F1	AGND	Analog Ground
F2	AGND	Analog Ground
F3	RCV1P	Receive Data Input (Positive) Channel 1
F8	RCV0P	Receive Data Input (Positive) Channel 0
F9	AGND	Analog Ground
F10	AGND	Analog Ground
G1	COMP_QL1P	Low-Side Comparator Output (Positive) Channel 1
G2	COMP_QL1N	Low-Side Comparator Output (Negative) Channel 1
G3	COMP_VTT1	Comparator Supply Termination Channel 1
G8	COMP_VTT0	Comparator Supply Termination Channel 0

Pin No.	Mnemonic	Description
G9	COMP_QL0N	Low-Side Comparator Output (Negative) Channel 0
G10	COMP_QL0P	Low-Side Comparator Output (Positive) Channel 0
H1	COMP_QH1P	High-Side Comparator Output (Positive) Channel 1
H2	COMP_QH1N	High-Side Comparator Output (Negative) Channel 1
H3	AGND	Analog Ground
H4	VSS	Supply (-5.0V)
H5	VDD	Supply (+10.75 V)
H6	VDD	Supply (+10.75 V)
H7	VSS	Supply (-5.0V)
H8	AGND	Analog Ground
H9	COMP_QH0N	High-Side Comparator Output (Negative) Channel 0
H10	COMP_QH0P	High-Side Comparator Output (Positive) Channel 0
J1	AGND	Analog Ground
J2	AGND	Analog Ground
J3	AGND	Analog Ground
J4	DAC16_MON	16-Bit DAC Monitor Mux Output
J5	DGND	Digital Ground
J6	SDIN	Serial Peripheral Interface (SPI) Data In
J7	RST	Serial Peripheral Interface (SPI) Reset
J8	AGND	Analog Ground
J9	AGND	Analog Ground
J10	AGND	Analog Ground
K1	MEASOUT01/TEMPSENSE	Muxed Output Shared by PMU MEASOUT Channel 0, PMU MEASOUT Channel 1/ Temperature Sense and Temperature Sense GND Reference
K2	DUTGND	DUT Ground Reference
K3	AGND	Analog Ground
K4	CS	Serial Peripheral Interface (SPI) Chip Select
K5	SDOUT	Serial Peripheral Interface (SPI) Data Out
K6	SCLK	Serial Peripheral Interface (SPI) Clock
K7	VCC	Supply (+3.3V)
K8	AGND	Analog Ground
K9	VREF	+5 V DAC Reference Voltage
K10	VREF_GND	DAC Ground Reference

TYPICAL PERFORMANCE CHARACTERISTICS

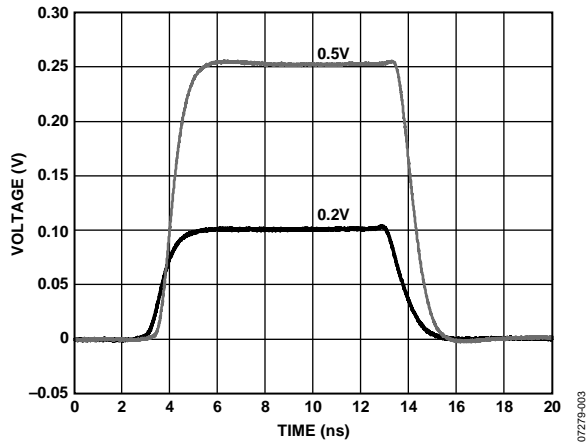

Figure 3. Driver Small Signal Response; $V_H = 0.2\text{ V}, 0.5\text{ V}$; $V_L = 0.0\text{ V}$; $50\ \Omega$ Termination

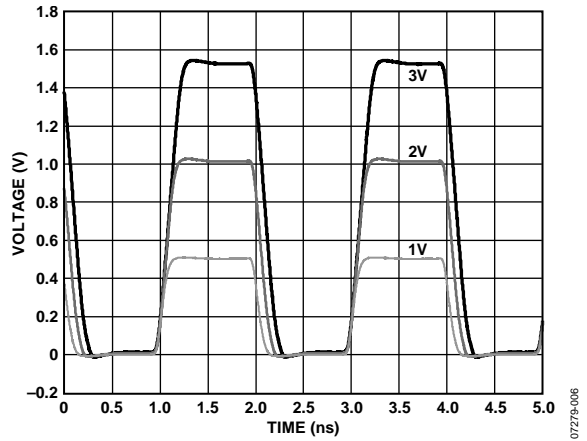

Figure 6. 50 MHz Driver Response; $V_H = 1.0\text{ V}, 2.0\text{ V}, 3.0\text{ V}$; $V_L = 0.0\text{ V}$; $50\ \Omega$ Termination

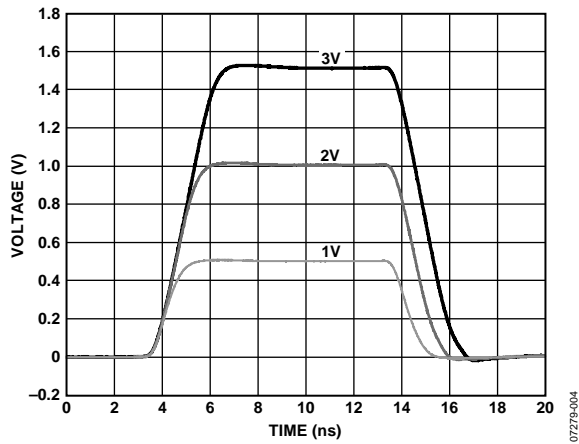

Figure 4. Driver Large Signal Response; $V_H = 1.0\text{ V}, 2.0\text{ V}, 3.0\text{ V}$; $V_L = 0.0\text{ V}$; $50\ \Omega$ Termination

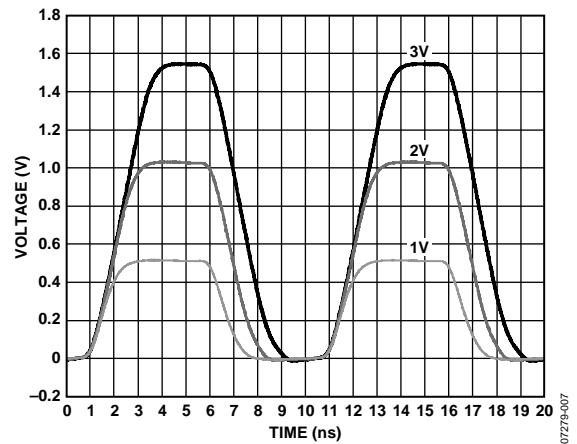

Figure 7. 100 MHz Driver Response; $V_H = 1.0\text{ V}, 2.0\text{ V}, 3.0\text{ V}$; $V_L = 0.0\text{ V}$; $50\ \Omega$ Termination

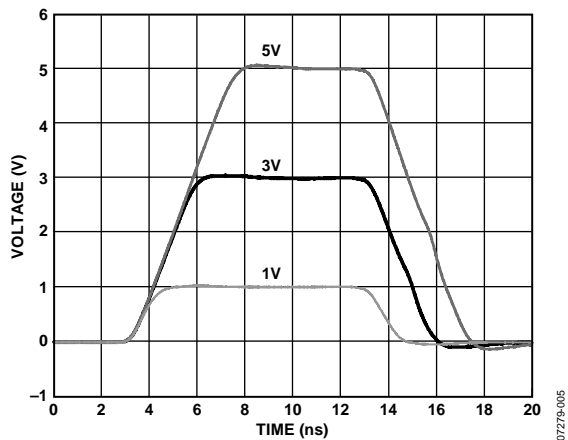

Figure 5. Driver Large Signal Response; $V_H = 1.0\text{ V}, 3.0\text{ V}, 5.0\text{ V}$; $V_L = 0.0\text{ V}$; $500\ \Omega$ Termination

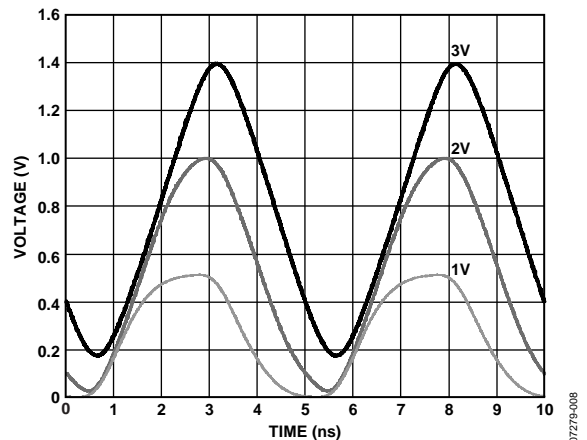

Figure 8. Response at 200 MHz; $V_H = 1.0\text{ V}, 2.0\text{ V}, 3.0\text{ V}$; $V_L = 0.0\text{ V}$; $50\ \Omega$ Termination

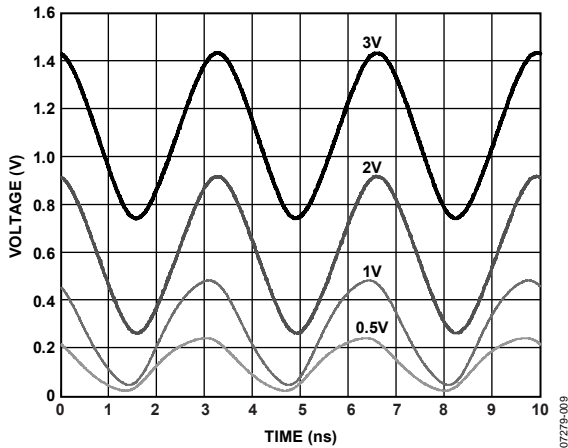

Figure 9. 300 MHz Driver Response; $V_H = 0.5\text{ V}, 1.0\text{ V}, 2.0\text{ V}, 3.0\text{ V}$; $V_L = 0.0\text{ V}$; $50\ \Omega$ Termination

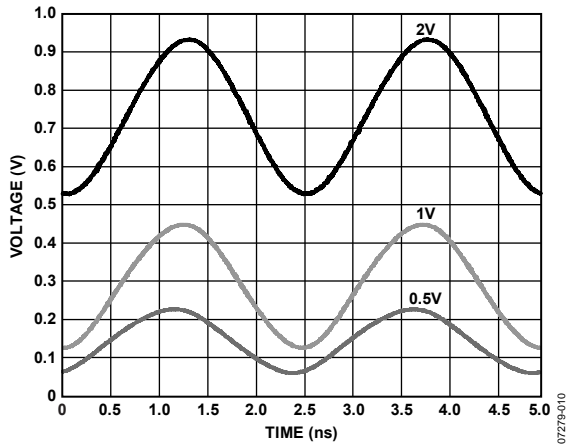

Figure 10. 400 MHz Driver Response; $V_H = 0.5\text{ V}, 1.0\text{ V}, 2.0\text{ V}$; $V_L = 0.0\text{ V}$; $50\ \Omega$ Termination

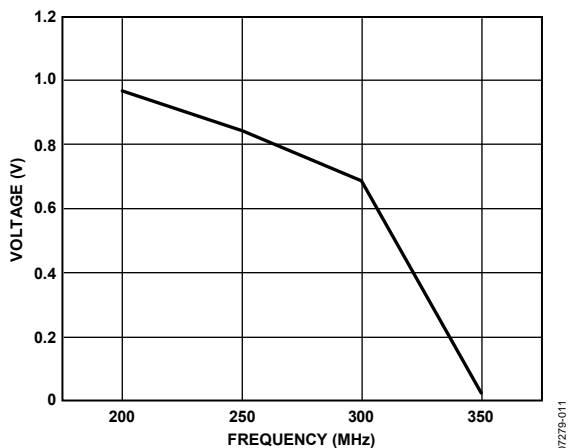

Figure 11. Driver Toggle Rate, $V_H = 2.0\text{ V}, V_L = 0.0\text{ V}$, $50\ \Omega$ Termination

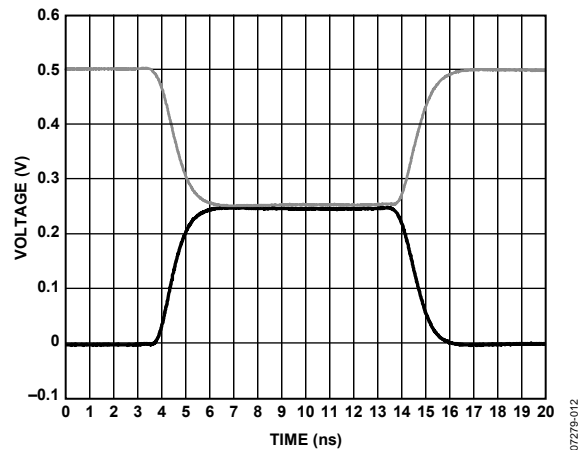

Figure 12. Driver Active (V_H and V_L) to and from V_{TERM} Transition; $V_H = 1.0\text{ V}, V_T = 0.5\text{ V}, V_L = 0.0\text{ V}$

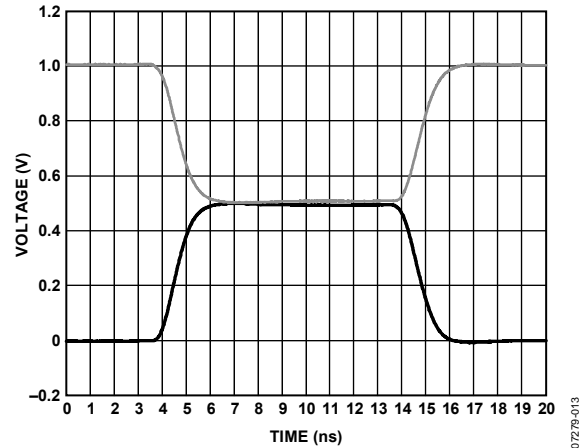

Figure 13. Driver Active (V_H and V_L) to and from V_{TERM} Transition; $V_H = 2.0\text{ V}, V_T = 1.0\text{ V}, V_L = 0.0\text{ V}$

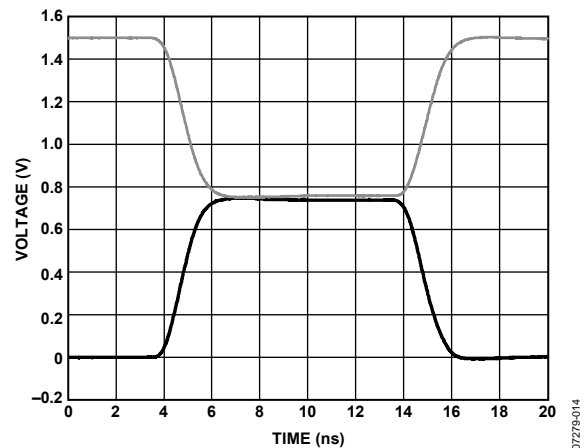

Figure 14. Driver Active (V_H and V_L) to and from V_{TERM} Transition; $V_H = 3.0\text{ V}, V_T = 1.5\text{ V}, V_L = 0.0\text{ V}$

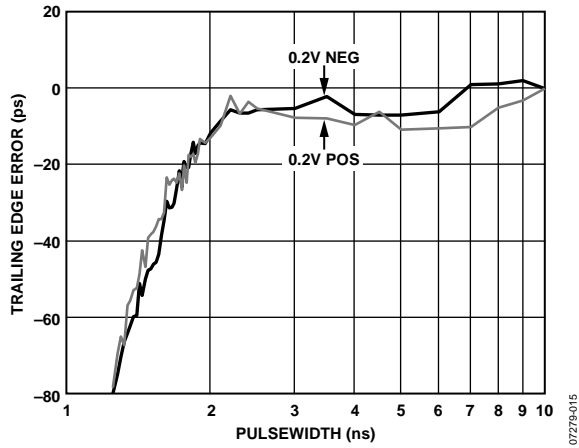

Figure 15. Driver Minimum Pulse Width; $V_H = 0.2\text{ V}$, $V_L = 0.0\text{ V}$

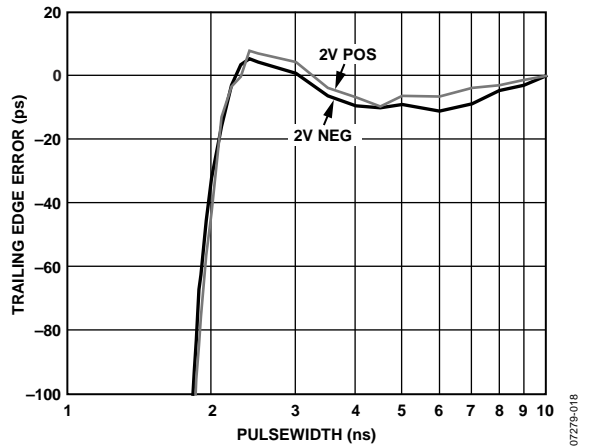

Figure 18. Driver Minimum Pulse Width; $V_H = 2.0\text{ V}$, $V_L = 0.0\text{ V}$

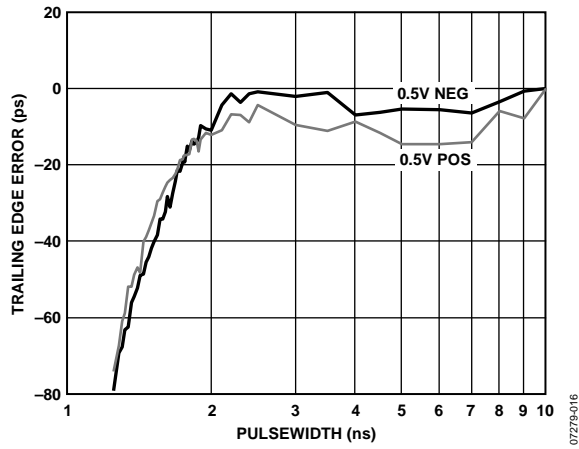

Figure 16. Driver Minimum Pulse Width; $V_H = 0.5\text{ V}$, $V_L = 0.0\text{ V}$

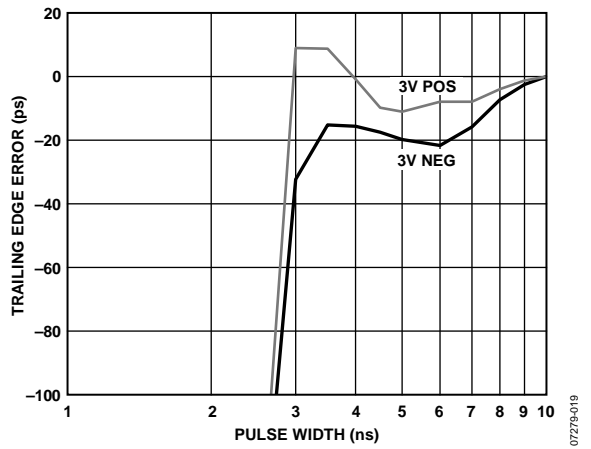

Figure 19. Driver Minimum Pulse Width; $V_H = 3.0\text{ V}$, $V_L = 0.0\text{ V}$

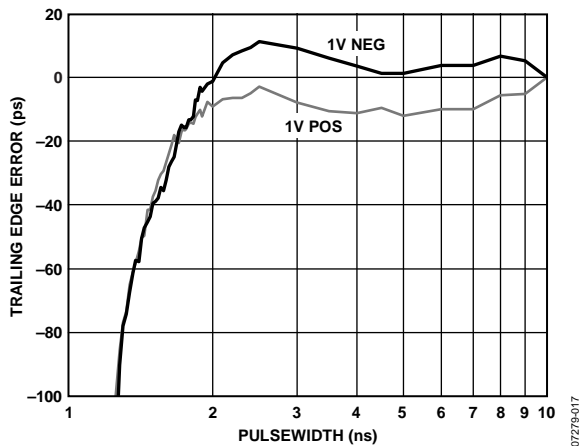

Figure 17. Driver Minimum Pulse Width; $V_H = 1.0\text{ V}$, $V_L = 0.0\text{ V}$

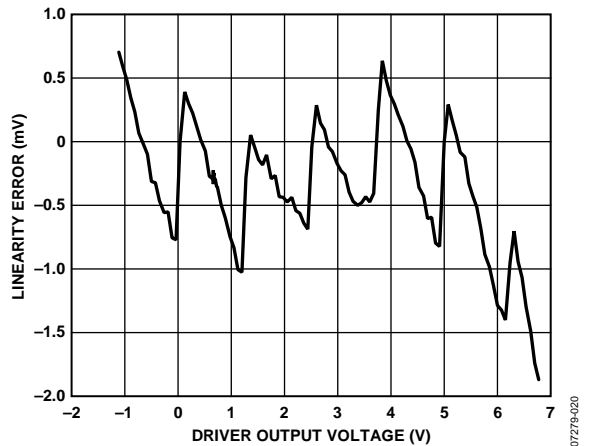

Figure 20. Driver V_H Linearity Error

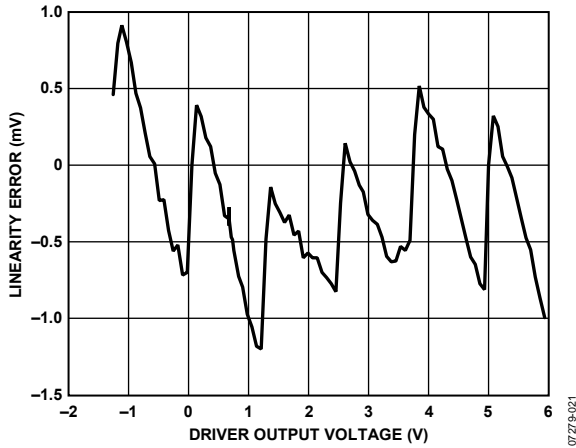

Figure 21. Driver VL Linearity Error

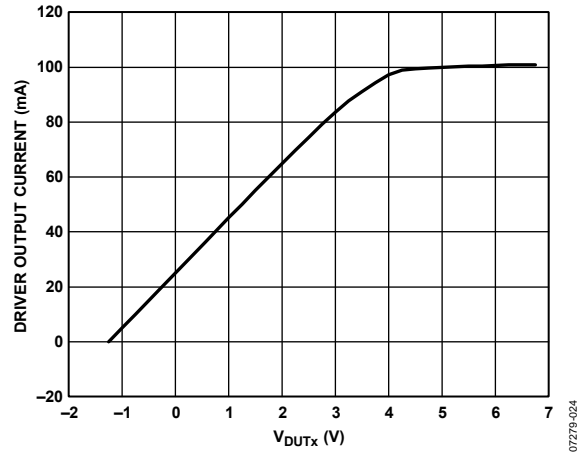

Figure 24. Driver Output Current Limit; Driver Programmed to -1.25 V ; V_{DUTx} Swept from -1.25 V to $+6.75\text{ V}$

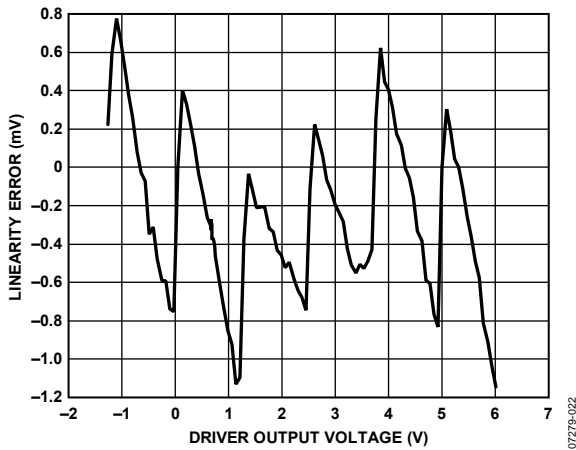

Figure 22. Driver VT Linearity Error

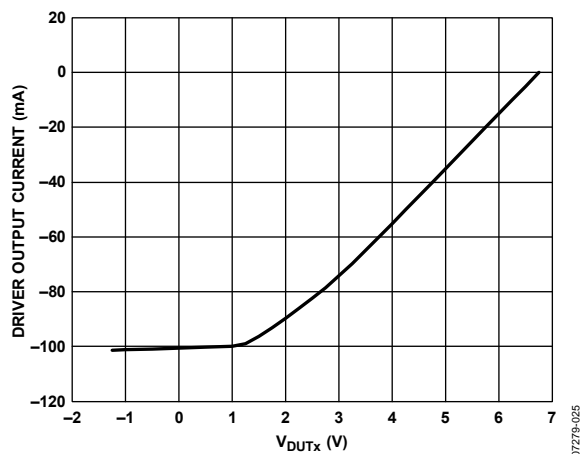

Figure 25. Driver Output Current Limit; Driver Programmed to 6.75 V ; V_{DUTx} Swept from -1.25 V to $+6.75\text{ V}$

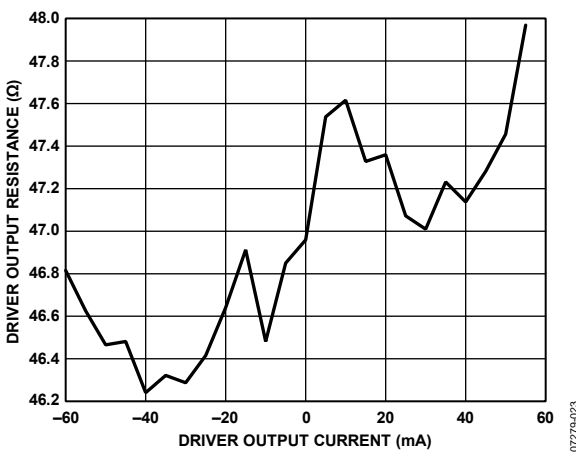

Figure 23. Driver Output Resistance vs. Output Current

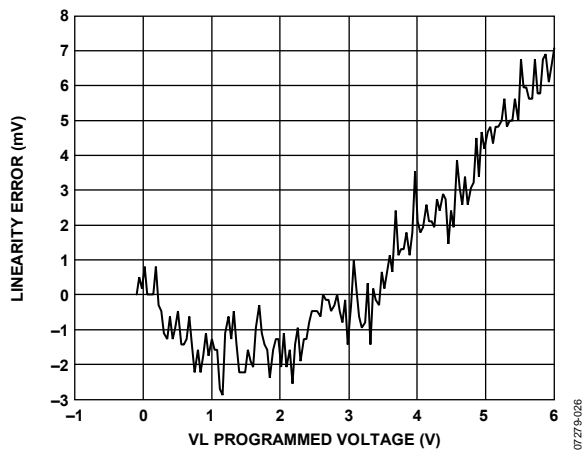

Figure 26. HVOUT VL Linearity Error

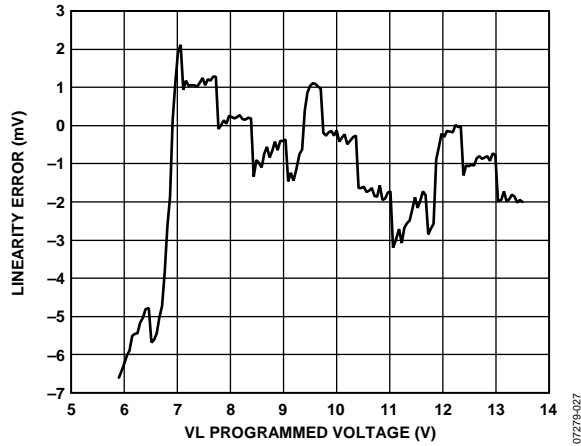

Figure 27. HVOUT VHH Linearity Error

07279-027

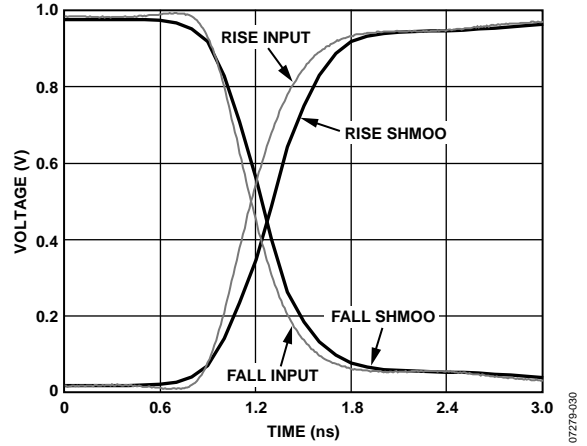

Figure 30. Comparator Shmoo, 1.0 V Input, 0.7 ns (10% to 90%) Input, 50 Ω Terminated

07279-030

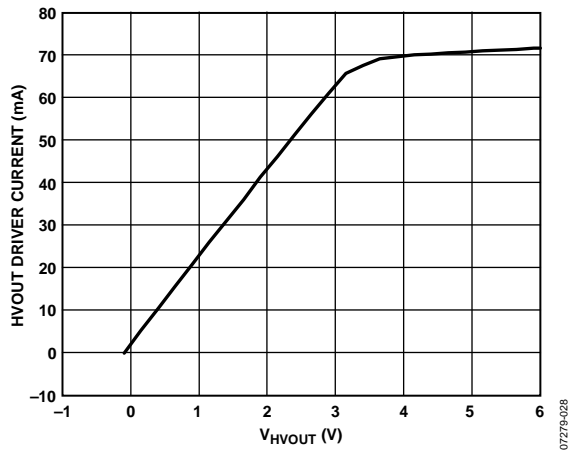

Figure 28. HVOUT VH Current Limit; $V_H = -0.1\text{ V}$; V_{HVOUT} Swept from -0.1 V to $+6.0\text{ V}$

07279-028

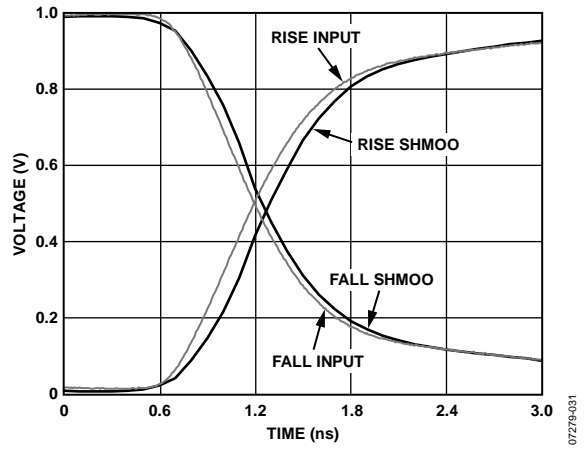

Figure 31. Comparator Shmoo, 1.5 V Input, 1.0 ns (10% to 90%) Input, 50 Ω Terminated

07279-031

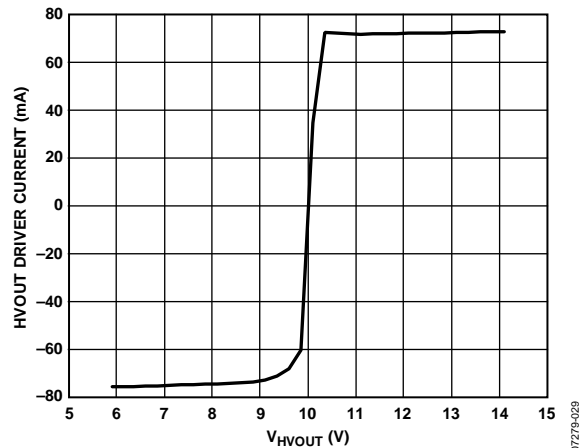

Figure 29. HVOUT VHH Current Limit; $V_{HH} = 10.0\text{ V}$; V_{HVOUT} Swept from -5.9 V to $+14.1\text{ V}$

07279-029

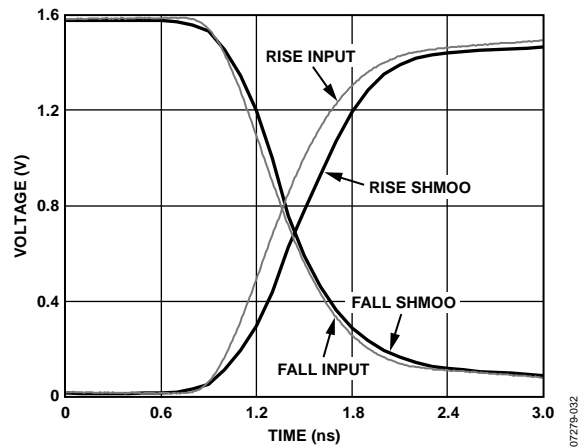

Figure 32. Comparator Shmoo, 1.5 V Input, 1.0 ns (10% to 90%) Input, 50 Ω Terminated

07279-032

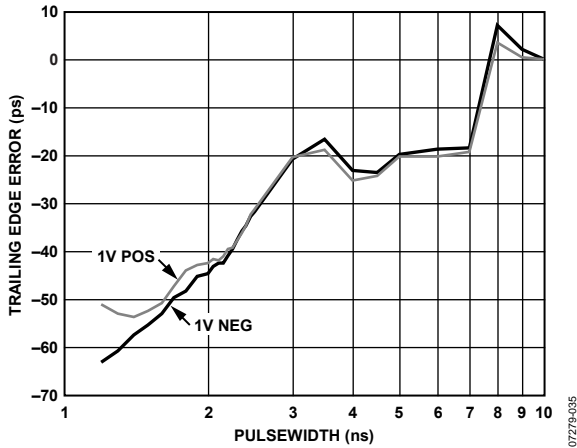

Figure 33. Comparator Minimum Pulse Width, 1.0 V

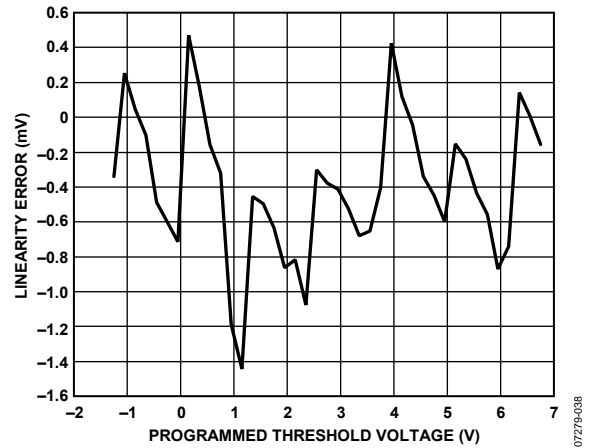

Figure 36. Comparator Threshold Linearity

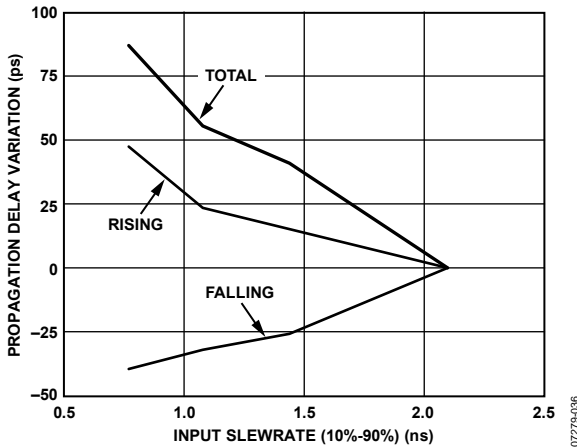

Figure 34. Comparator Slew Rate Dispersion, Input Swing = 1.5 V, Comparator Threshold = 0.75 V

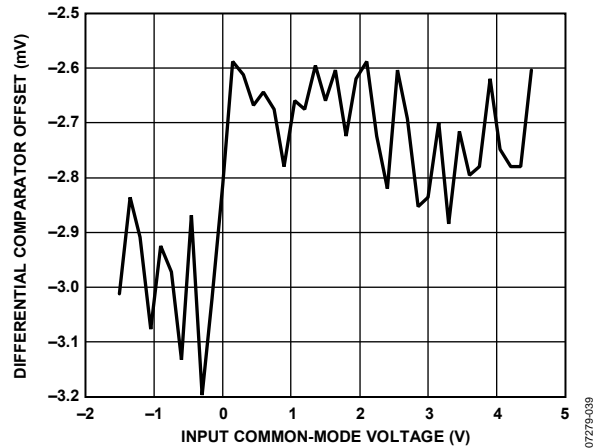

Figure 37. Differential Comparator CMRR

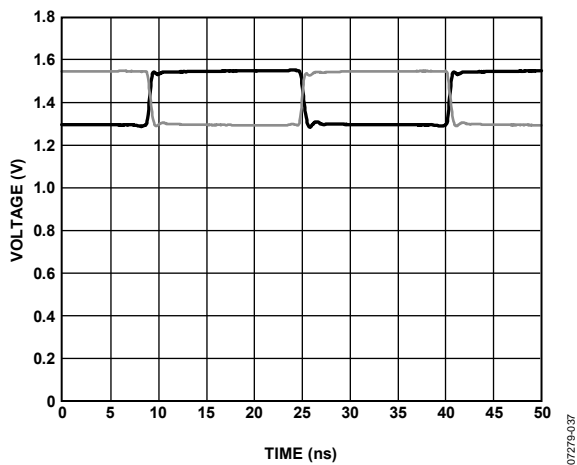

Figure 35. Comparator Output Waveform, COMP_QH0P, COMP_QH0N

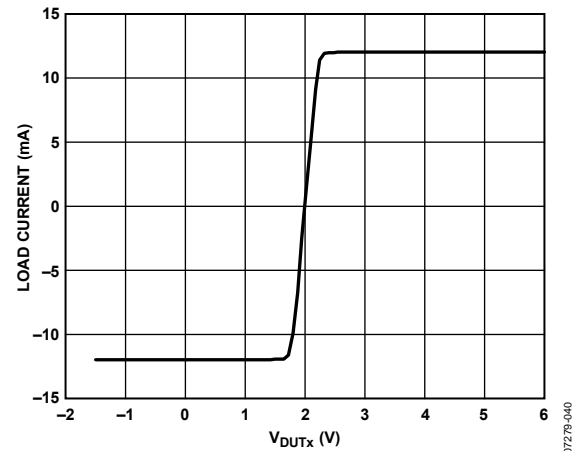

Figure 38. Active Load Commutation Response; V_{COM} = 2.0 V; I_{OH} = I_{OL} = 12 mA

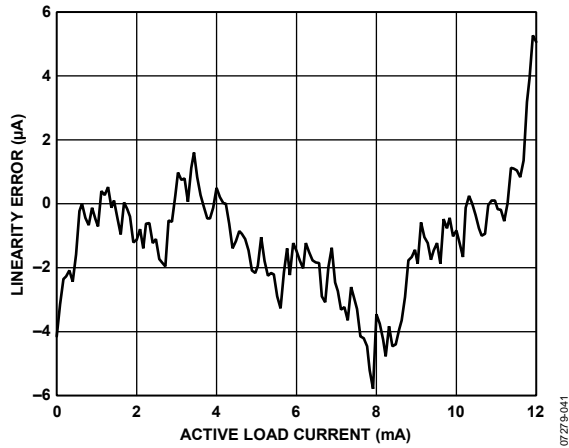

Figure 39. Active Load Current Linearity

07Z79-041

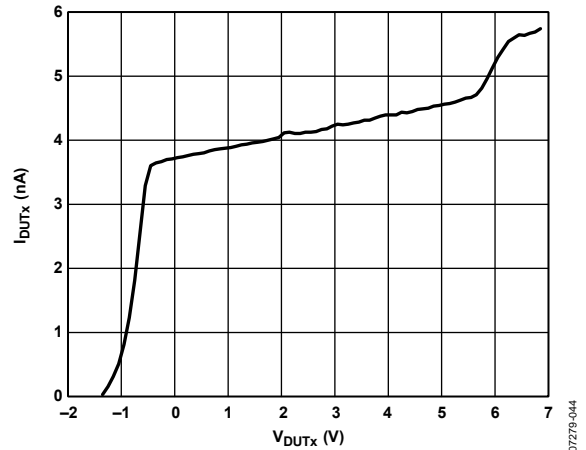

Figure 42. DUTx Pin Leakage in High-Z Mode

07Z79-044

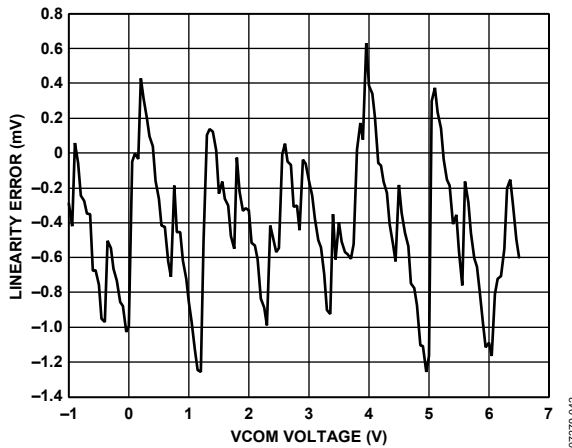

Figure 40. Active Load VCOM Linearity

07Z79-042

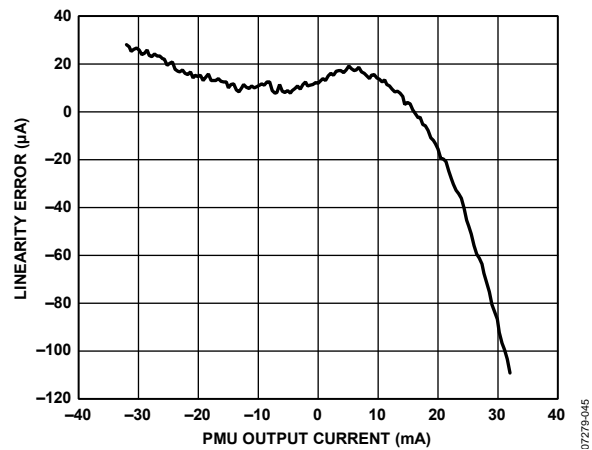

Figure 43. PMU Force Current Range A Linearity

07Z79-045

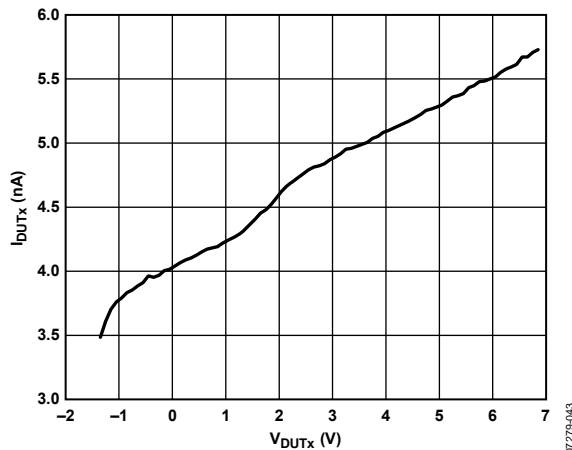

Figure 41. DUTx Pin Leakage in Low Leakage Mode

07Z79-043

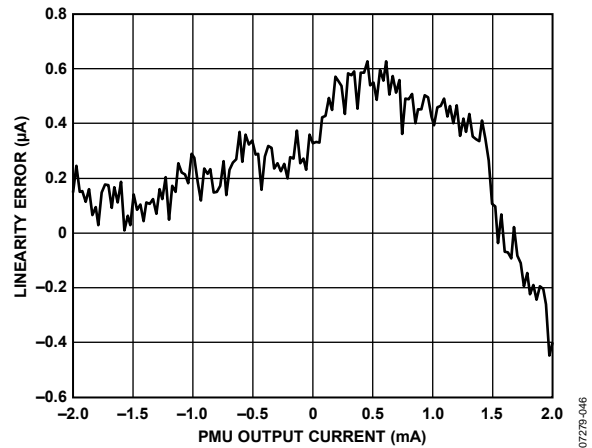

Figure 44. PMU Force Current Range B Linearity

07Z79-046

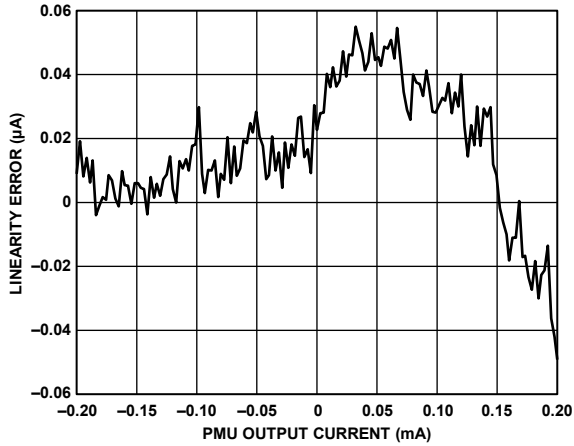

Figure 45. PMU Force Current Range C Linearity

07279-047

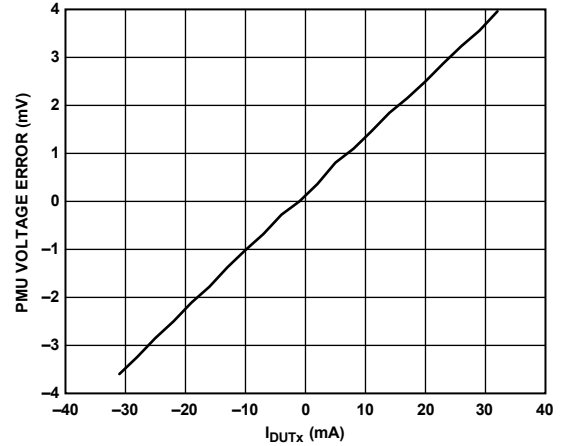

Figure 48. PMU Force Voltage Range A Output Voltage Error at 6.75 V vs. Output Current

07279-050

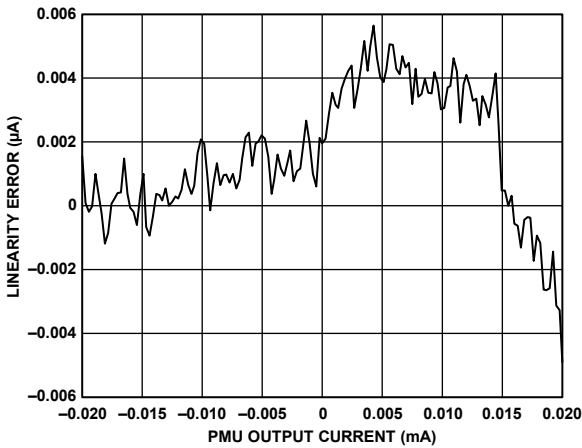

Figure 46. PMU Force Current Range D Linearity

07279-048

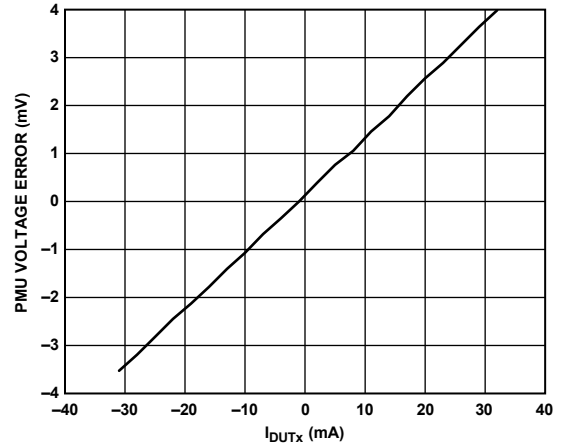

Figure 49. PMU FV Range A Output Voltage Error at -1.25 V vs. Output Current

07279-051

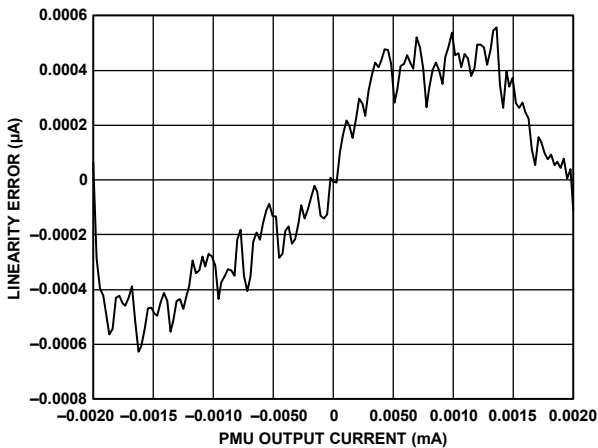

Figure 47. PMU Force Current Range E Linearity

07279-049

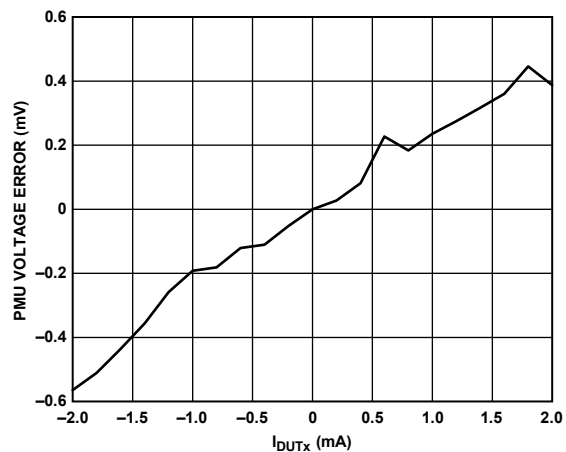

Figure 50. PMU FV Range B Output Voltage Error at 6.75 V vs. Output Current

07279-052

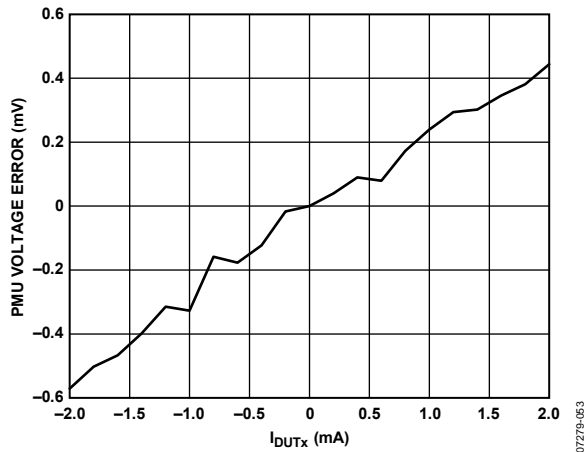

Figure 51. PMU FV Range B Output Voltage Error at -1.25 V vs. Output Current

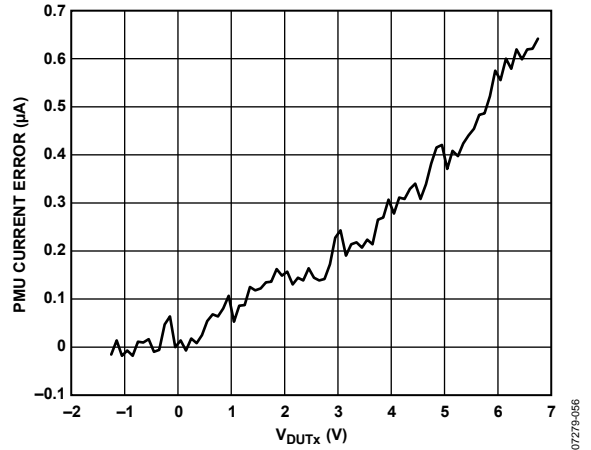

Figure 54. PMU FI Range B Output Current Error at -2 mA vs. Output Voltage; Output Voltage Is Pulled Externally

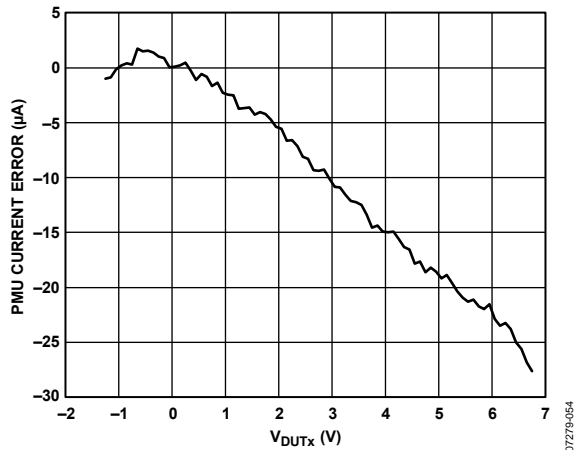

Figure 52. PMU FI Range A Output Current Error at -32 mA vs. Output Voltage; Output Voltage Is Pulled Externally

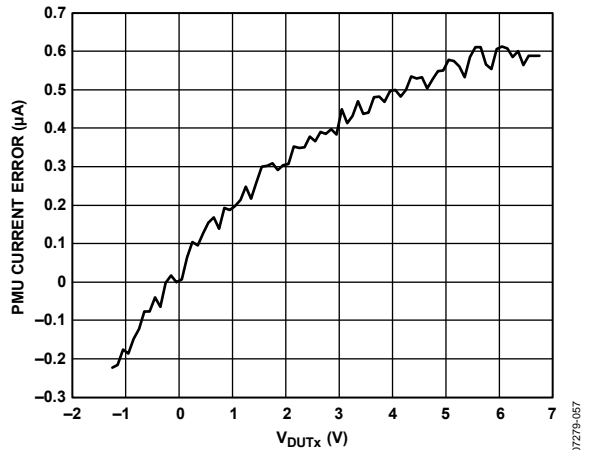

Figure 55. PMU FI Range B Output Current Error at $+2\text{ mA}$ vs. Output Voltage; Output Voltage Is Pulled Externally

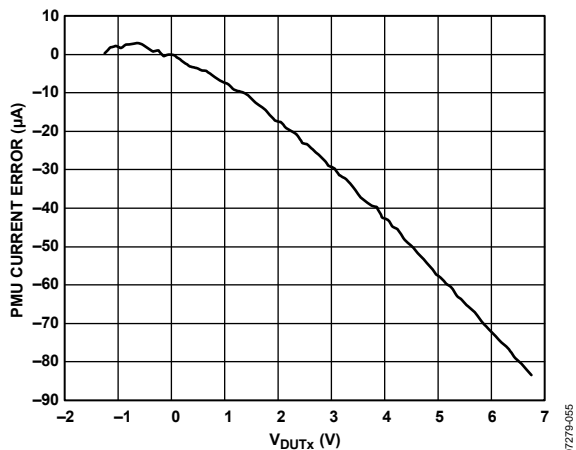

Figure 53. PMU FI Range A Output Current Error at $+32\text{ mA}$ vs. Output Voltage; Output Voltage Is Pulled Externally

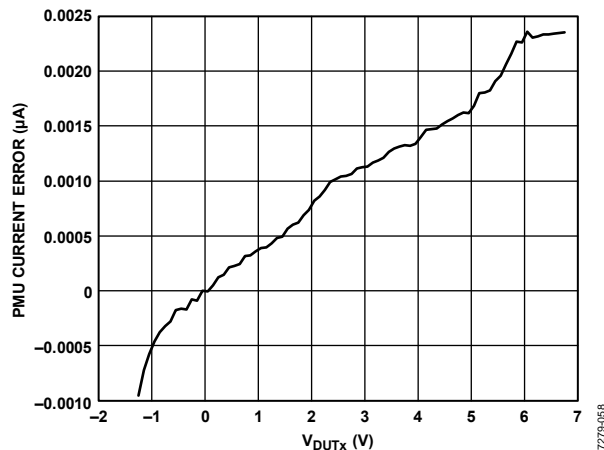

Figure 56. PMU FI Range E Output Current Error at -2 µA vs. Output Voltage; Output Voltage Is Pulled Externally

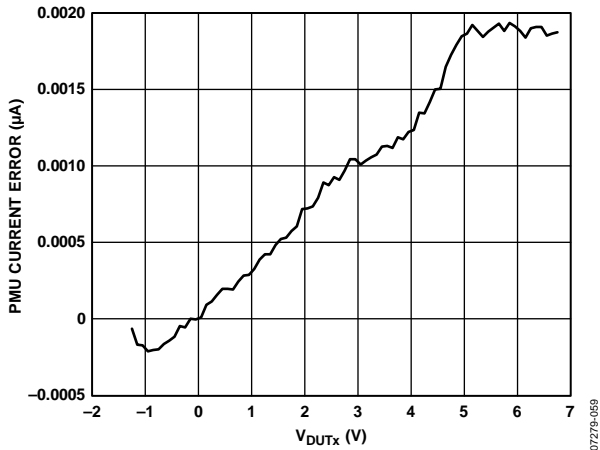

Figure 57. PMU FI Range E Output Current Error at +2 µA vs. Output Voltage; Output Voltage Is Pulled Externally

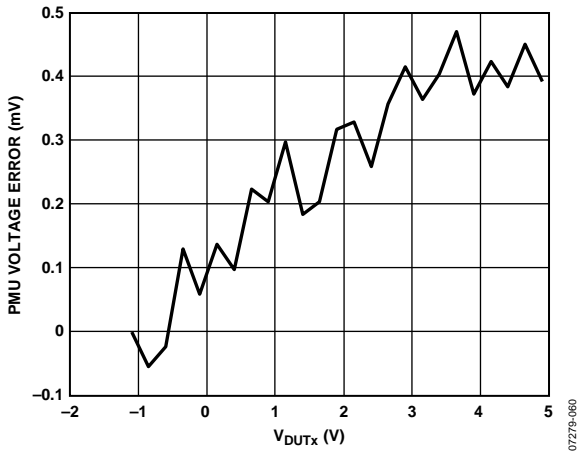

Figure 58. PMU Measure Current Range B CMRR, Externally Pulling 1 mA, FVMI

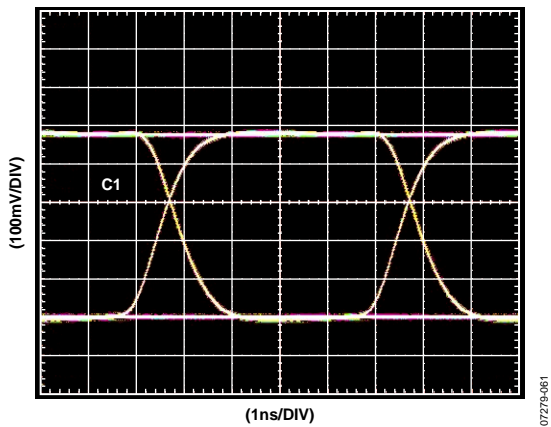

Figure 59. Eye Diagram, 200 Mbps, PRBS31; VH = 1.0 V, VL = 0.0 V

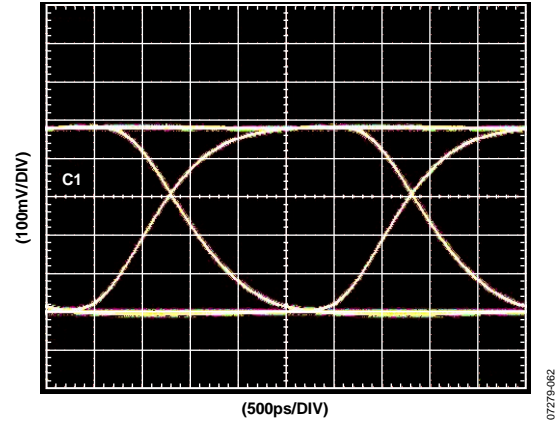

Figure 60. Eye Diagram, 400 Mbps, PRBS31; VH = 1.0 V, VL = 0.0 V

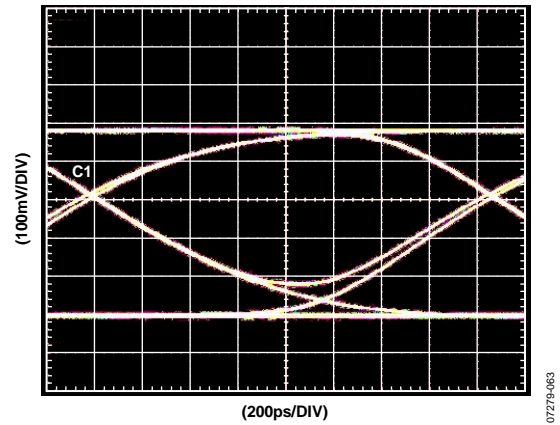

Figure 61. Eye Diagram, 600 Mbps, PRBS31; VH = 1.0 V, VL = 0.0 V

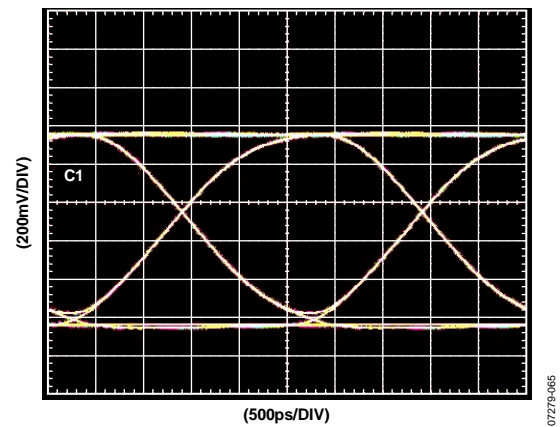

Figure 62. Eye Diagram, 400 Mbps, PRBS31; VH = 2.0 V, VL = 0.0 V

SPI DETAILS

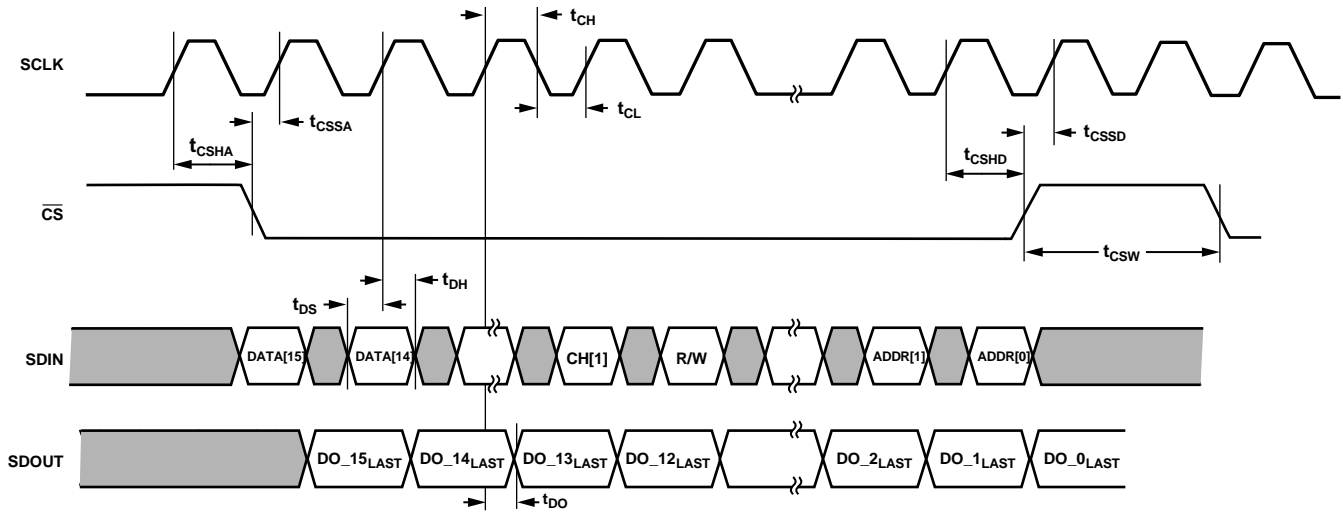

Figure 63. SPI Timing Diagram

07279-067

Table 17. Serial Peripheral Interface Timing Requirements

Symbol	Parameter	Min	Max	Unit
t _{CH}	SCLK minimum high	9.0		ns
t _{CL}	SCLK minimum low	9.0		ns
t _{CSHA}	\overline{CS} assert hold	3.0		ns
t _{CSSA}	\overline{CS} assert setup	3.0		ns
t _{CSHD}	\overline{CS} deassert hold	3.0		ns
t _{CSSD}	\overline{CS} deassert setup	3.0		ns
t _{DH}	SDIN hold	3.0		ns
t _{DS}	SDIN setup	3.0		ns
t _{DO}	SDOUT data out		15.0	ns
t _{CSW}	\overline{CS} minimum between assertions ¹	2		SCLK cycles
	\overline{CS} minimum directly after a read request	3		SCLK cycles
t _{CSTP}	Minimum delay after \overline{CS} is deasserted before SCLK can be stopped (not shown in Figure 63); this allows any internal operations to complete	16		SCLK cycles

¹ An extra cycle is needed after a read request to prime the read data into the SPI shift register.

DEFINITION OF SPI WORD

The SPI can accept variable length words, depending on the operation. At most, the word length equals 24 bits: 16 bits of data, two channel selects, one read/write (R/W) selector, and a 5-bit address.

Depending on the operation, the data can be smaller or, in the case of a read operation, nonexistent.

Table 18. Channel Selection

Channel 1	Channel 0	Channel Selected
0	0	NOP (no channel selected, no register changes)
0	1	Channel 0 selected
1	0	Channel 1 selected
1	1	Channel 0 and Channel 1 selected

Table 19. R/W Definition

R/W	Description
0	Current register specified by address shifts out of SDOOUT on next shift operation
1	Current data written to the register specified by address and channel select

Example 1: 16-Bit Write

Write 16 bits of data to a register or DAC; ignore unused MSBs. For example, Bit 15 and Bit 14 are ignored, and Bit 13 through Bit 0 are applied to the 14-bit DAC.

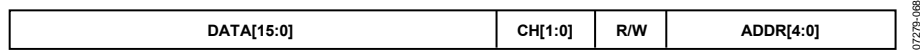

Figure 64. 16-Bit Write

Example 2: 14-Bit Write

Write 14 bits of data to the DAC.

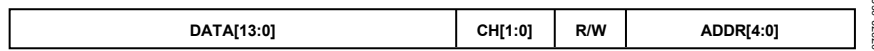

Figure 65. 14-Bit Write

Example 3a: 2-Bit Write

Write two bits of data to the 2-bit register.

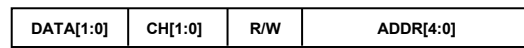

Figure 66. 2-Bit Write

Example 3b: 2-Bit Write

Write two bits of data to the 2-bit register. Bit 15 through Bit 2 are ignored and Bit 1 through Bit 0 are applied to the register.



Figure 67. 2-Bit Write

Example 4: Read Request

Read request and follow with a second instruction (can be NOP) to clock out the data.

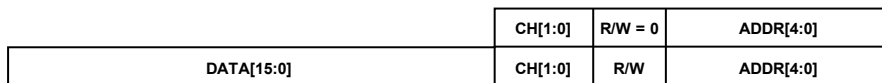
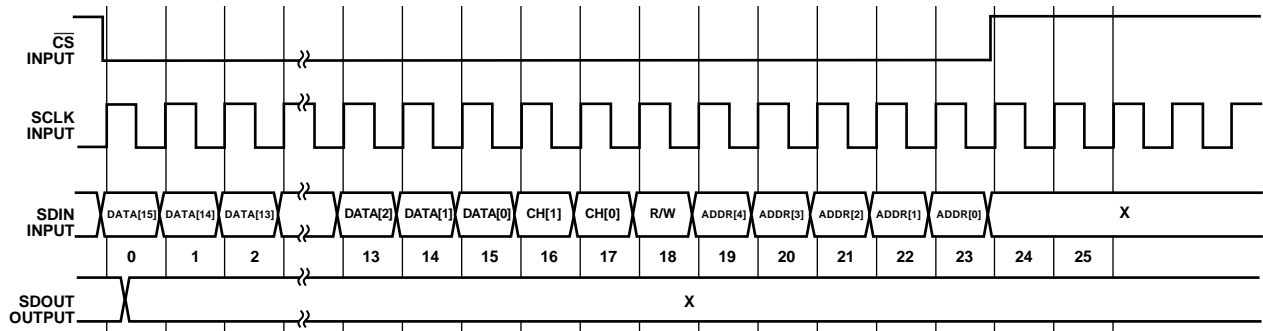

Figure 68. Read Request

WRITE OPERATION



- NOTES**
 1. R/W = 1.
 2. X = DON'T CARE.

07279-073

Figure 69. 16-Bit SPI Write

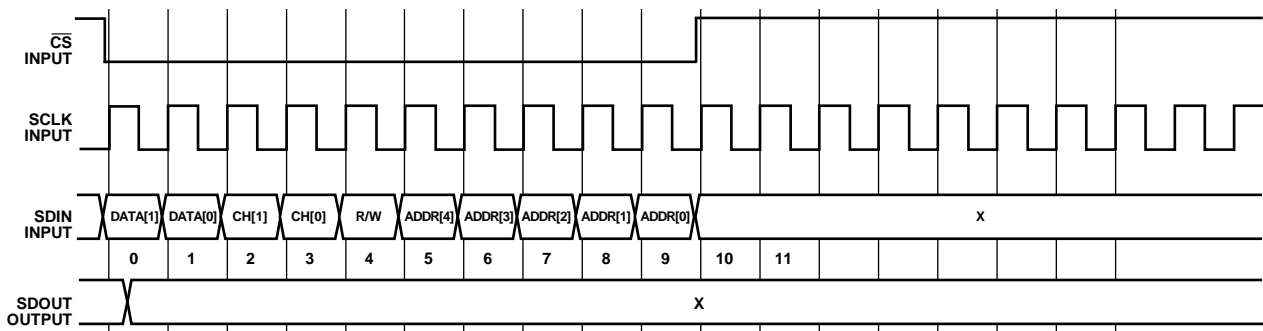

- NOTES**
 1. R/W = 1.
 2. X = DON'T CARE.

07279-074

Figure 70. 2-Bit SPI Write

READ OPERATION

The read operation is a two-stage operation. First, a word is shifted in, specifying which register to read. CS is deasserted for three clock cycles, and then a second word is shifted in to obtain the readback data. This second word can be either another operation or an NOP address.

If another operation is shifted in, it must shift in at least eight bits of data to read back the previous specified data. The NOP address can be used for this read if there is no need to read/write another register. To maintain the clarity of the operation, it is strongly recommended that the NOP address be used for all reads.

Any register read that is fewer than 16 bits has zeros filled in the top bits to make it a 16-bit word.

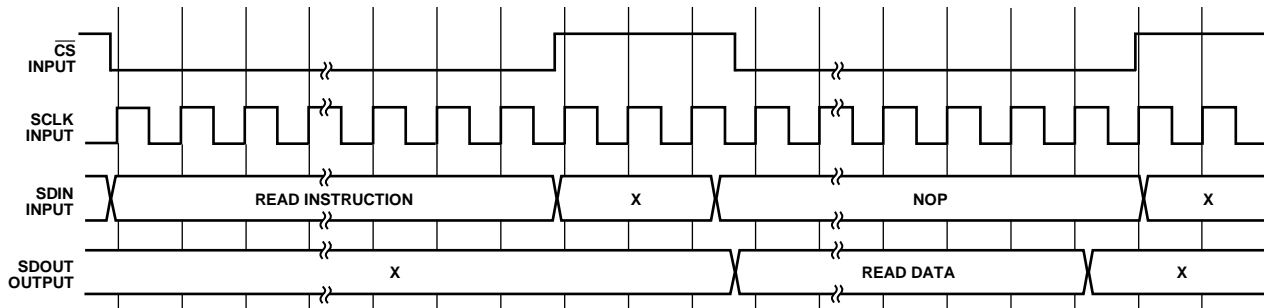

NOTES
1. X = DON'T CARE.

Figure 71. SPI Read Overview

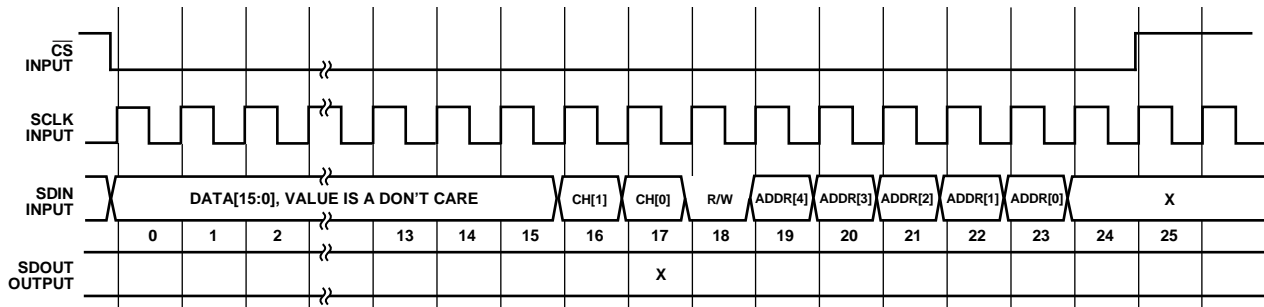

NOTES
1. X = DON'T CARE.

Figure 72. SPI Read—Details of Read Request

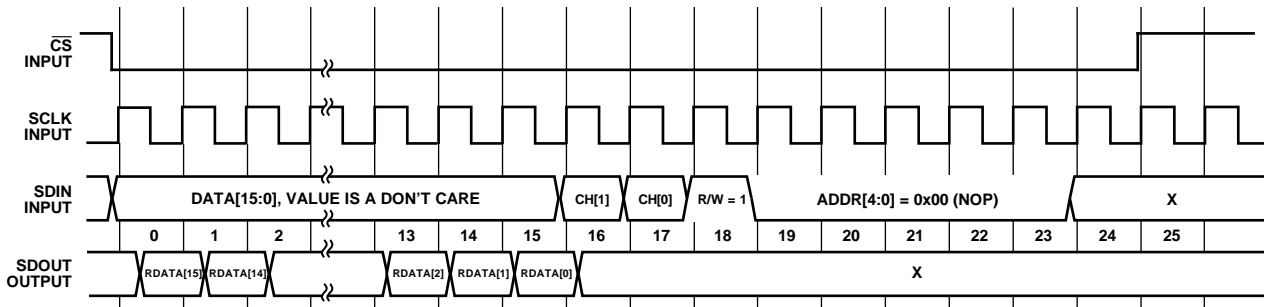

NOTES
1. RDATA IS THE REGISTER VALUE BEING READ.
2. X = DON'T CARE.

Figure 73. SPI Read—Details of Read Out

RESET OPERATION

The ADATE304 contains an asynchronous reset feature. The ADATE304 can be reset to the default values shown in Table 20 by utilizing the $\overline{\text{RST}}$ pin.

To initiate the reset operation, deassert the $\overline{\text{RST}}$ pin for a minimum of 100 ns and deassert the $\overline{\text{CS}}$ pin for a minimum of two SCLK cycles.

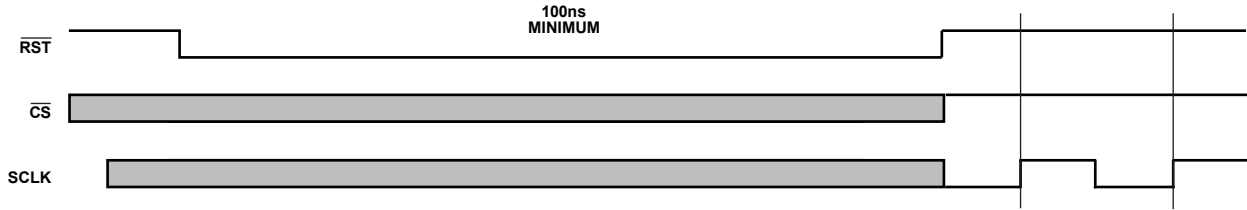

MINIMUM OF TWO SCLK EDGES AFTER ASSERTING $\overline{\text{RST}}$ BEFORE RESUMING NORMAL OPERATION.

Figure 74. Reset Operation

REGISTER MAP

The ADDR[4:0] bits determine the destination register of the data being written to the ADATE304.

Table 20. Register Selection

DATA[15:0]	CH[1:0]	R/W	ADDR[4:0]	Register Selected	Reset State
N/A ¹	N/A	N/A	0x00	NOP	N/A
DATA[13:0]	CH[1:0]	R/W	0x01	VH DAC level	4096d
DATA[13:0]	CH[1:0]	R/W	0x02	VL DAC level	4096d
DATA[13:0]	CH[1:0]	R/W	0x03	VT/VCOM DAC level	4096d
DATA[13:0]	CH[1:0]	R/W	0x04	VOL DAC level	4096d
DATA[13:0]	CH[1:0]	R/W	0x05	VOH DAC level	4096d
DATA[13:0]	CH[1:0]	R/W	0x06	VCH DAC level	4096d
DATA[13:0]	CH[1:0]	R/W	0x07	VCL DAC level	4096d
DATA[13:0]	CH[1:0]	R/W	0x08	V(IOH) DAC level	4096d
DATA[13:0]	CH[1:0]	R/W	0x09	V(IOL) DAC level	4096d
DATA[13:0]	CH[1]	R/W	0x0A	OVD high level	4096d
DATA[13:0]	CH[0]	R/W	0x0A	OVD low level	4096d
DATA[15:0]	CH[1:0]	R/W	0x0B	PMUDAC level	16384d
DATA[2:0]	CH[1:0]	R/W	0x0C	PE/PMU enable	000b
DATA[2:0]	CH[1:0]	R/W	0x0D	Channel state	000b
DATA[9:0]	CH[1:0]	R/W	0x0E	PMU state	0d
DATA[2:0]	CH[1:0]	R/W	0x0F	PMU measure enable	000b
DATA[0]	CH[1:0]	R/W	0x10	Differential comparator enable	0b
DATA[1:0]	CH[1:0]	R/W	0x11	16-bit DAC monitor	00b
DATA[1:0]	CH[1:0]	R/W	0x12	OVD_CHx alarm mask	01b
DATA[2:0]	CH[1:0]	R	0x13	OVD_CHx alarm state	N/A
N/A	N/A	N/A	0x14 to 0x1F	Reserved	N/A

¹ N/A means not applicable.

DETAILS OF REGISTERS

Table 21. PE/PMU Enable (ADDR[4:0] = 0x0C)

Bit	Name	Description
DATA[2]	PMU enable	0 = disable PMU force output and clamps, place PMU in MV mode 1 = enable PMU force output When set to 0, the PMU state bits are ignored, except for the PMU sense path (DATA[7])
DATA[1]	Force VT	0 = normal driver operation 1 = force driver to V_T See Table 29 for complete functionality of this bit
DATA[0]	PE disable	0 = enable driver functions 1 = disable driver (low leakage) See Table 29 for complete functionality of this bit

Table 22. Channel State (ADDR[4:0] = 0x0D)

Bit	Name	Description
DATA[2]	HV mode select	0 = HV driver in low impedance. 1 = enable HV driver. This bit affects Channel 0 only. Ensure that the Channel 0 bit in SPI write is active. Channel 1 bit in SPI write is don't care.
DATA[1]	Load enable	0 = disable load. 1 = enable load. See Table 29 for complete functionality of this bit.
DATA[0]	Driver high-Z or VT	0 = enable Driver high-Z function. 1 = enable Driver VTERM function. See Table 29 for complete functionality of this bit.

Table 23. PMU State (ADDR[4:0] = 0x0E)^{1, 2}

Bit	Name	Description
DATA[9:8]	PMU input selection	00 = V_{DUTGND} (calibrated for 0.0 V voltage reference) 01 = $2.5 V + V_{DUTGND}$ (calibrated for 0.0 A current reference) 1X = PMUDAC
DATA[7]	PMU sense path	0 = internal sense 1 = external sense
DATA[6]	Reserved	
DATA[5]	PMU clamp enable	0 = disable clamps 1 = enable clamps
DATA[4]	PMU measure voltage or current	0 = measure voltage mode 1 = measure current mode
DATA[3]	PMU force voltage or current	0 = force voltage mode 1 = force current mode
DATA[2:0]	PMU range	0XX = 2 μ A range 100 = 20 μ A range 101 = 200 μ A range 110 = 2 mA range 111 = 32 mA range

¹ Note that when ADDR[4:0] = 0x0C, the PMU enable bit (DATA[2]) = 0, PMU force outputs and clamps are disabled, and the PMU is placed into measure voltage mode. PMU State DATA[9:8] and DATA[6:0] are ignored, and only the DATA[7] PMU sense path is valid.

² X means don't care.

Table 24. PMU Measure Enable (ADDR[4:0] = 0x0F)¹

Bit	Name	Description
DATA[2:1]	MEASOUT01 select	00 = PMU MEASOUT Channel 0 01 = PMU MEASOUT Channel 1 10 = Temperature sensor ground reference 11 = Temperature sensor
DATA[0]	MEASOUT01 output enable	0 = MEASOUT01 is tristated 1 = MEASOUT01 is enabled

¹ This register is written to or read from when either of the CH[1:0] bits is 1.

Table 25. Differential Comparator Enable (ADDR[4:0] = 0x10)¹

Bit	Name	Description
DATA[0]	Differential Comparator Enable	0 = differential comparator is disabled; the Channel 0 normal window comparator (NWC) outputs are located on Channel 0 1 = differential comparator is enabled; the differential comparator outputs are located on Channel 0

¹ This register is written to or read from when either of the CH[1:0] bits is 1.

Table 26. DAC16_MON (16-Bit DAC Monitor) (ADDR[4:0] = 0x11)¹

Bit	Name	Description
DATA[1]	16-Bit DAC mux enable	0 = 16-bit DAC mux is tristated 1 = 16-bit DAC mux is enabled
DATA[0]	16-Bit DAC mux select	0 = 16-bit DAC Channel 0 1 = 16-bit DAC Channel 1

¹ This register is written to or read from when either of the CH[1:0] bits is 1.

Table 27. OVD_CHx Alarm Mask (ADDR[4:0] = 0x12)

Bit	Name	Description
DATA[1]	PMU mask	0 = disable PMU alarm flag 1 = enable PMU alarm flag
DATA[0]	OVD mask	0 = disable OVD alarm flag 1 = enable OVD alarm flag

Table 28. OVD_CHx Alarm State (ADDR[4:0] = 0x13)¹

Bit	Name	Description
DATA[2]	PMU clamp flag	0 = PMU is not clamped 1 = PMU is clamped
DATA[1]	OVD high flag	0 = DUT voltage < OVD high voltage 1 = DUT voltage > OVD high voltage
DATA[0]	OVD low flag	0 = DUT voltage > OVD low voltage 1 = DUT voltage < OVD low voltage

¹ This register is a read-only register.

USER INFORMATION

POWER SUPPLY CONSIDERATIONS

Power Supply Sequencing

It is recommended that the power supplies be brought up in the following order:

1. Grounds (DGND, AGND, VREF_GND)
2. V_{SS}
3. V_{CC} , V_{COMP_VTT} , and V_{REF}
4. V_{DD}
5. V_{PLUS}

If the HVOUT pin is not used, the V_{PLUS} supply can be connected to V_{DD} .

Power Supply Decoupling

The ADATE304 is a high performance device that requires close attention to power supply decoupling to deliver the best performance. The use of full power planes with low inductance capacitors placed as close to the power pins as possible is recommended. The following power connections are the most important:

- V_{PLUS} to AGND (for the HVOUT driver)
- V_{DD} to V_{SS} near the DUTx pin (for the driver)
- V_{DD} and V_{SS} to AGND near the DUTx pin (for the comparators)
- V_{CC} to DGND (for the digital)

Additionally, large bulk capacitors (that is, 10 μ F) must be used on every power supply on the printed circuit board (PCB).

TRUTH TABLES

Table 29. Driver and Load Truth Table¹

Registers				Signals		Driver State	Load State
PE Disable DATA[0] ADDR[4:0] = 0x0C	Force VT DATA[1] ADDR[4:0] = 0x0C	Load Enable DATA[1] ADDR[4:0] = 0x0D	Driver High-Z/VT DATA[0] ADDR[4:0] = 0x0D	DATAx	RCVx		
1	X	X	X	X	X	High-Z without clamps	Power-down
0	1	X	X	X	X	VT	Power-down
0	0	0	0	0	0	VL	Power-down
0	0	0	0	0	1	High-Z with clamps	Power-down
0	0	0	0	1	0	VH	Power-down
0	0	0	0	1	1	High-Z with clamps	Power-down
0	0	0	1	0	0	VL	Power-down
0	0	0	1	0	1	VT	Power-down
0	0	0	1	1	0	VH	Power-down
0	0	0	1	1	1	VT	Power-down
0	0	1	0	0	0	VL	Active off
0	0	1	0	0	1	High-Z with clamps	Active on
0	0	1	0	1	0	VH	Active off
0	0	1	0	1	1	High-Z with clamps	Active on
0	0	1	1	0	0	VL	Active on
0	0	1	1	0	1	High-Z with clamps	Active on
0	0	1	1	1	0	VH	Active on
0	0	1	1	1	1	High-Z with clamps	Active on

¹ X means don't care.

Table 30. HVOUT Truth Table¹

HVOUT Mode Select DATA[2] ADDR[4:0] = 0x0D	Channel 0 RCV	Channel 0 DATA	HVOUT Driver Output
1	1	X	VHH mode; $V_{HH} = (V_T + 1 V) \times 2 + DUT_{GND}$ (Channel 0 VT DAC)
1	0	0	VL (Channel 0 VL DAC)
1	0	1	VH (Channel 0 VH DAC)
0	X	X	Disabled (HVOUT pin set to 0 V low impedance)

¹ X means don't care.

Table 31. Comparator Truth Table

Differential Comparator Enable DATA[0] ADDR[4:0] = 0x10	COMP_QH0	COMP_QL0	COMP_QH1	COMP_QL1
0	Normal window mode Logic high: $VOH0 < V_{DUT0}$ Logic low: $VOH0 > V_{DUT0}$	Normal window mode Logic high: $VOL0 < V_{DUT0}$ Logic low: $VOL0 > V_{DUT0}$	Normal window mode Logic high: $VOH1 < V_{DUT1}$ Logic low: $VOH1 > V_{DUT1}$	Normal window mode Logic high: $VOL1 < V_{DUT1}$ Logic low: $VOL1 > V_{DUT1}$
1	Differential comparator mode Logic high: $VOH0 < V_{DUT0} - V_{DUT1}$ Logic low: $VOH0 > V_{DUT0} - V_{DUT1}$	Differential comparator mode Logic high: $VOL0 < V_{DUT0} - V_{DUT1}$ Logic low: $VOL0 > V_{DUT0} - V_{DUT1}$	Normal window mode Logic high: $VOH1 < V_{DUT1}$ Logic low: $VOH1 > V_{DUT1}$	Normal window mode Logic high: $VOL1 < V_{DUT1}$ Logic low: $VOL1 > V_{DUT1}$

DETAILS OF DACs vs. LEVELS

There are ten 14-bit DACs per channel. These DACs provide levels for the driver, comparator, load currents, VHH buffer, OVD, and clamp levels. There are three versions of output levels as follows:

- -2.5 V to +7.5 V and tracks DUTGND. Controls the VH, VL, VT/VCOM/VHH, VOH, VOL, VCH, and VCL levels.

- -3.0 V to +7.0 V and tracks DUTGND. Controls the OVD levels.
- -2.5 V to +7.5 V and does not track DUTGND. Controls the IOH and IOL levels.

There is one 16-bit DAC per channel. This DAC provides the levels for the PMU. The output level is as follows:

- -2.5 V to +7.5 V and tracks DUTGND; controls the PMU levels.

Table 32. Level Transfer Functions

DAC Transfer Function	Programmable Range ¹ (All 0s to All 1s)	Levels
$V_{OUT} = 2.0 \times (V_{REF} - V_{REF_GND}) \times (Code/(2^{14})) - 0.5 \times (V_{REF} - V_{REF_GND}) + V_{DUTGND}$ $Code = [V_{OUT} - V_{DUTGND} + 0.5 \times (V_{REF} - V_{REF_GND})] \times [(2^{14})/(2.0 \times (V_{REF} - V_{REF_GND}))]$	-2.5 V to +7.5 V	VH, VL, VT/VCOM, VOL, VOH, VCH, VCL
$V_{OUT} = 4.0 \times (V_{REF} - V_{REF_GND}) \times (Code/(2^{14})) - 1.0 \times (V_{REF} - V_{REF_GND}) + 2.0 + V_{DUTGND}$ $Code = [V_{OUT} - V_{DUTGND} - 2.0 + 1.0 \times (V_{REF} - V_{REF_GND})] \times [(2^{14})/(4.0 \times (V_{REF} - V_{REF_GND}))]$	-3.0 V to +17.0 V	VHH
$V_{OUT} = 2.0 \times (V_{REF} - V_{REF_GND}) \times (Code/(2^{14})) - 0.6 \times (V_{REF} - V_{REF_GND}) + V_{DUTGND}$ $Code = [V_{OUT} - V_{DUTGND} + 0.6 \times (V_{REF} - V_{REF_GND})] \times [(2^{14})/(2.0 \times (V_{REF} - V_{REF_GND}))]$	-3.0 V to +7.0 V	OVD
$I_{OUT} = [2.0 \times (V_{REF} - V_{REF_GND}) \times (Code/(2^{14})) - 0.5 \times (V_{REF} - V_{REF_GND})] \times (0.012/5.0)$ $Code = [(I_{OUT} \times (5.0/0.012)) + 0.5 \times (V_{REF} - V_{REF_GND})] \times [(2^{14})/(2.0 \times (V_{REF} - V_{REF_GND}))]$	-6 mA to +18 mA	IOH, IOL
$V_{OUT} = 2.0 \times (V_{REF} - V_{REF_GND}) \times (Code/(2^{16})) - 0.5 \times (V_{REF} - V_{REF_GND}) + V_{DUTGND}$ $Code = [V_{OUT} - V_{DUTGND} + 0.5 \times (V_{REF} - V_{REF_GND})] \times [(2^{16})/(2.0 \times (V_{REF} - V_{REF_GND}))]$	-2.5 V to +7.5 V	PMUDAC
$I_{OUT} = [2.0 \times (V_{REF} - V_{REF_GND}) \times (Code/(2^{16})) - 0.5 \times (V_{REF} - V_{REF_GND}) - 2.5] \times (0.050/5.0)$ $Code = [(I_{OUT} \times (5.0/0.050)) + 2.5 + 0.5 \times (V_{REF} - V_{REF_GND})] \times [(2^{16})/(2.0 \times (V_{REF} - V_{REF_GND}))]$	-50 mA to +50 mA	PMUDAC (PMU FI Range A)
$I_{OUT} = [2.0 \times (V_{REF} - V_{REF_GND}) \times (Code/(2^{16})) - 0.5 \times (V_{REF} - V_{REF_GND}) - 2.5] \times (0.004/5.0)$ $Code = [(I_{OUT} \times (5.0/0.004)) + 2.5 + 0.5 \times (V_{REF} - V_{REF_GND})] \times [(2^{16})/(2.0 \times (V_{REF} - V_{REF_GND}))]$	-4 mA to +4 mA	PMUDAC (PMU FI Range B)
$I_{OUT} = [2.0 \times (V_{REF} - V_{REF_GND}) \times (Code/(2^{16})) - 0.5 \times (V_{REF} - V_{REF_GND}) - 2.5] \times (0.0004/5.0)$ $Code = [(I_{OUT} \times (5.0/0.0004)) + 2.5 + 0.5 \times (V_{REF} - V_{REF_GND})] \times [(2^{16})/(2.0 \times (V_{REF} - V_{REF_GND}))]$	-400 µA to +400 µA	PMUDAC (PMU FI Range C)
$I_{OUT} = [2.0 \times (V_{REF} - V_{REF_GND}) \times (Code/(2^{16})) - 0.5 \times (V_{REF} - V_{REF_GND}) - 2.5] \times (0.00004/5.0)$ $Code = [(I_{OUT} \times (5.0/0.00004)) + 2.5 + 0.5 \times (V_{REF} - V_{REF_GND})] \times [(2^{16})/(2.0 \times (V_{REF} - V_{REF_GND}))]$	-40 µA to +40 µA	PMUDAC (PMU FI Range D)
$I_{OUT} = [2.0 \times (V_{REF} - V_{REF_GND}) \times (Code/(2^{16})) - 0.5 \times (V_{REF} - V_{REF_GND}) - 2.5] \times (0.000004/5.0)$ $Code = [(I_{OUT} \times (5.0/0.000004)) + 2.5 + 0.5 \times (V_{REF} - V_{REF_GND})] \times [(2^{16})/(2.0 \times (V_{REF} - V_{REF_GND}))]$	-4 µA to +4 µA	PMUDAC (PMU FI Range E)

¹ Programmable range includes a margin outside the specified part performance, allowing for offset/gain calibration.

Table 33. Load Transfer Functions

Load Level	Transfer Function ¹
IOL	$V(IOL)/5 V \times 12 mA$
IOH	$V(IOH)/5 V \times 12 mA$

¹ V(IOH)and V(IOL) DAC levels are not referenced to DUTGND.

Table 34. PMU Transfer Functions

PMU Mode	Transfer Functions
Force Voltage	$V_{OUT} = PMUDAC$
Measure Voltage	$V_{MEASOUT01} = V_{DUTx}$ (internal sense) or $V_{MEASOUT01} = V_{PMUS_CHx}$ (external sense)
Force Current	$I_{OUT} = [PMUDAC - (V_{REF}/2)]/(R^1 \times 5)$
Measure Current	$V_{MEASOUT01} = (V_{REF}/2) + V_{DUTGND} + (I_{DUTx} \times 5 \times R^1)$

¹ R = 15.5 Ω for Range A; 250 Ω for Range B; 2.5 kΩ for Range C; 25 kΩ for Range D; 250 kΩ for Range E.

Table 35. PMU User Required Capacitors

Capacitor	Location
220 pF	Across Pin C10 (FFCAP_0B) and Pin E10 (FFCAP_0A)
220 pF	Across Pin C1 (FFCAP_1B) and Pin E1 (FFCAP_1A)
330 pF	Between GND and Pin B9 (SCAP0)
330 pF	Between GND and Pin B2 (SCAP1)

Table 36. Temperature Sensor

Temperature	Output
0 K	0 V
300 K	3 V
x K	(x K) × 10 mV/K

Table 37. Power Supply Ranges

Parameter	Range 1	Range 2
Nominal VDD	+10.75 V	+10.0 V
Nominal VSS	-5.00 V	-5.75 V
Driver		
VH range	-1.15 V to +6.75 V	-1.9 V to +6.0 V
VL range	-1.25 V to +6.65 V	-2.0 V to +5.9 V
VT range	-1.25 V to +6.75 V	-2.0 V to +6.0 V
Functional Amplitude	8.0 V	8.0 V
Reflection Clamp		
VCH Range	-1.0 V to +6.75 V	-1.0 V to +6.0 V
VCL Range	-1.25 V to +5.75 V	-2.0 V to +5.0 V
Comparator Input Voltage Range	-1.25 V to +6.75 V	-2.0 V to +6.0 V
Active Load VCOM Range	-1.00 V to +6.50 V	-1.75 V to +5.75 V
PMU		
Force Voltage Range	-1.25 V to +6.75 V	-2.0 V to +6.0 V
Measure Voltage Range	-1.25 V to +6.75 V	-2.0 V to +6.0 V
Force Current Voltage Range	-1.25 V to +6.75 V	-2.0 V to +6.0 V
Measure Current Voltage Range	-1.25 V to +6.75 V	-2.0 V to +6.0 V
Low Clamp Range	-1.25 V to +4.75 V	-2.0 V to +4.0 V
High Clamp Range	0.75 V to 6.75 V	0.0 V to 6.0 V
OVD	-2.25 V to +7.0 V	-3.0 V to +7.0 V

Table 38. Default Test Conditions (Range 1)

Name	Default Test Condition
VH DAC Level	+2.0 V
VL DAC Level	+0.0 V
VT/VCOM DAC Level	+1.0 V
VOL DAC Level	-1.0 V
VOH DAC Level	+6.0 V
VCH DAC Level	+7.5 V
VCL DAC Level	-2.5 V
IOH DAC Level	0.0 A
IOL DAC Level	0.0 A
OVD Low DAC Level	-2.5 V
OVD High DAC Level	+6.5 V
PMUDAC DAC Level	0.0 V
PE/PMU Enable	0x0000: PMU disabled, VT not forced through driver, PE enabled
Channel State	0x0000: HV mode disabled, load disabled, VTERM inactive
PMU State	0x0000: Input of DUTGND, internal sense, clamps disabled, FVMV, Range E
PMU Measure Enable	0x0000: MEASOUT01 pin tristated
Differential Comparator Enable	0x0000: Normal window comparator mode
16-Bit DAC Monitor	0x0000: DAC16_MON tristated
OVD_CHx Alarm Mask	0x0000: disable alarm functions
Data Input	Logic low
Receive Input	Logic low
DUTx Pin	Unterminated
Comparator Output	Unterminated

RECOMMENDED PMU MODE SWITCHING SEQUENCES

To minimize any possible aberrations and voltage spikes on the DUT output, specific mode switching sequences are recommended for the following transitions:

- PMU disable to PMU enable.
- PMU force voltage mode to PMU force current mode.
- PMU force current mode to PMU force voltage mode.

PMU Disable to PMU Enable

Note that, in Table 39 through Table 49, X indicates the don't care bit.

Step 1. Table 39 lists the state of the registers in PMU disabled mode.

Table 39.

Register	Bits	Setting
PE/PMU Enable Register, ADDR[4:0] = 0x0C	DATA[2]	0
PMU State Register, ADDR[4:0] = 0x0E	DATA[9:8]	XX
	DATA[7]	X
	DATA[6]	X
	DATA[5]	X
	DATA[4]	X
	DATA[3]	X
	DATA[2:0]	XXX

Step 2. Write to Register ADDR[4:0] = 0x0E (see Table 40).

Table 40.

Register	Bits	Setting	Comments
PMU State Register, ADDR[4:0] = 0x0E	DATA[9:8]	1X or 00	Set desired input selection
	DATA[7]	X	
	DATA[6]	X	
	DATA[5]	X	
	DATA[4]	X	
	DATA[3]	0	This bit must be set to force voltage mode to reduce aberrations
	DATA[2:0]	XXX	

Step 3. Write to Register ADDR[4:0] = 0x0C (see Table 41).

Table 41.

Register	Bits	Setting	Comments
PE/PMU Enable Register, ADDR[4:0] = 0x0C	DATA[2]	1	PMU is now enabled in force voltage mode

PMU Force Voltage Mode to PMU Force Current Mode

Step 1. Table 42 lists the state of registers in force voltage mode.

Table 42.

Register	Bits	Setting
PE/PMU Enable Register, ADDR[4:0] = 0x0C	DATA[2]	1
PMU State Register, ADDR[4:0] = 0x0E	DATA[9:8]	XX
	DATA[7]	X
	DATA[6]	X
	DATA[5]	X
	DATA[4]	X
	DATA[3]	0
	DATA[2:0]	XXX

Step 2. Write to Register ADDR[4:0] = 0x0E (see Table 43).

Table 43.

Register	Bits	Setting	Comments
PMU State Register, ADDR[4:0] = 0x0E	DATA[9:8]	01	Set 2.5 V + DUTGND input selection
	DATA[7]	X	
	DATA[6]	X	
	DATA[5]	X	
	DATA[4]	X	Set to force current mode
	DATA[3]	1	
	DATA[2:0]	0XX	

Step 3. Write to Register ADDR[4:0] = 0x0B (see Table 44).

Table 44.

Register	Bits	Setting	Comments
VIN 16-Bit DAC, ADDR[4:0] = 0x0B	DATA[15:0]	X	Update the VIN 16-Bit DAC register to the desired value

Step 4. Write to Register ADDR[4:0] = 0x0E (see Table 45).

Table 45.

Register	Bits	Setting	Comments
PMU State Register, ADDR[4:0] = 0x0E	DATA[9:8]	1X	Set VIN input selection
	DATA[7]	X	
	DATA[6]	X	
	DATA[5]	X	
	DATA[4]	X	
	DATA[3]	1	Set to the desired current range
	DATA[2:0]	XXX	

Transition from PMU Force Current Mode to PMU Force Voltage Mode

Step 1. Table 46 lists the state of the registers in force current mode.

Table 46.

Register	Bits	Setting
PE/PMU Enable Register, ADDR[4:0] = 0x0C	DATA[2]	1
PMU State Register, ADDR[4:0] = 0x0E	DATA[9:8]	XX
	DATA[7]	X
	DATA[6]	X
	DATA[5]	X
	DATA[4]	X
	DATA[3]	1
	DATA[2:0]	XXX

Step 2. Write to Register ADDR[4:0] = 0x0E (see Table 47).

Table 47.

Register	Bits	Setting	Comments
PMU State Register, ADDR[4:0] = 0x0E	DATA[9:8]	00	Set DUTGND input selection
	DATA[7]	X	
	DATA[6]	X	
	DATA[5]	X	
	DATA[4]	X	
	DATA[3]	0	Set to force voltage mode
	DATA[2:0]	XXX	Set to the desired current range

Step 3. Write to Register ADDR[4:0] = 0x0B (see Table 48).

Table 48.

Register	Bits	Setting	Comments
VIN 16-Bit DAC, ADDR[4:0] = 0x0B	DATA[15:0]	X	Update the VIN 16-Bit DAC register to the desired value

Step 4. Write to Register ADDR[4:0] = 0x0E (see Table 49).

Table 49.

Register	Bits	Setting	Comments
PMU State Register, ADDR[4:0] = 0x0E	DATA[9:8]	1X	Set VIN input selection
	DATA[7]	X	
	DATA[6]	X	
	DATA[5]	X	
	DATA[4]	X	
	DATA[3]	0	Force voltage mode
	DATA[2:0]	XXX	

BLOCK DIAGRAMS

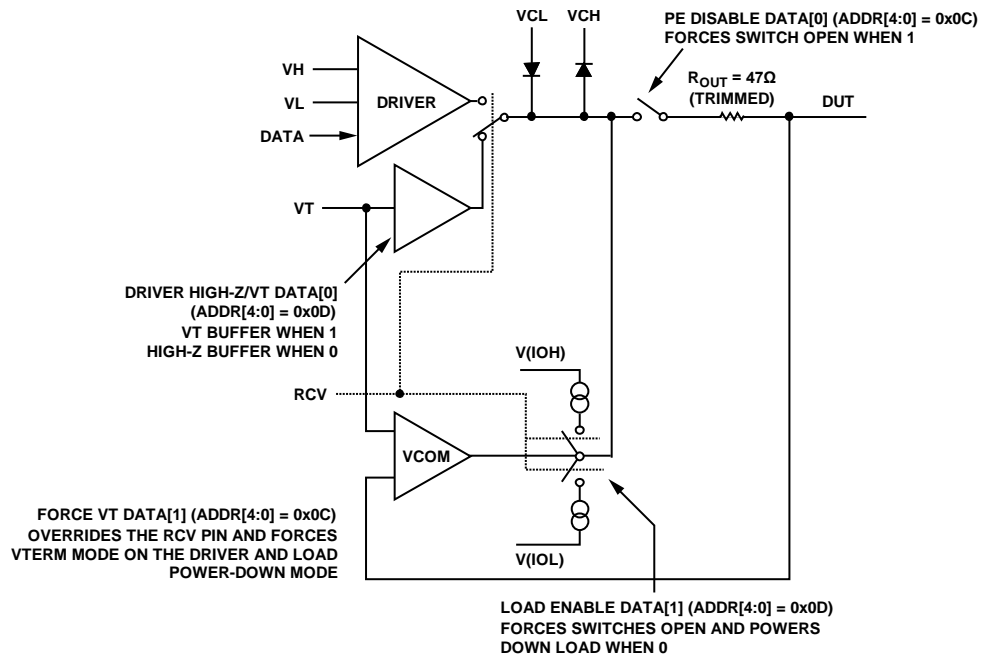

Figure 75. Driver and Load Block Diagram

07279-079

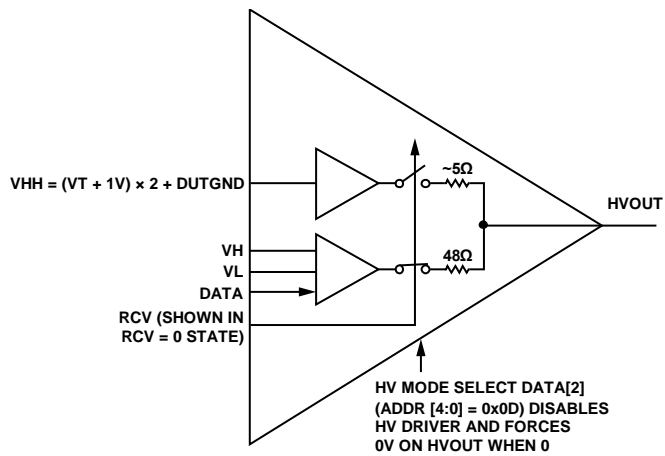
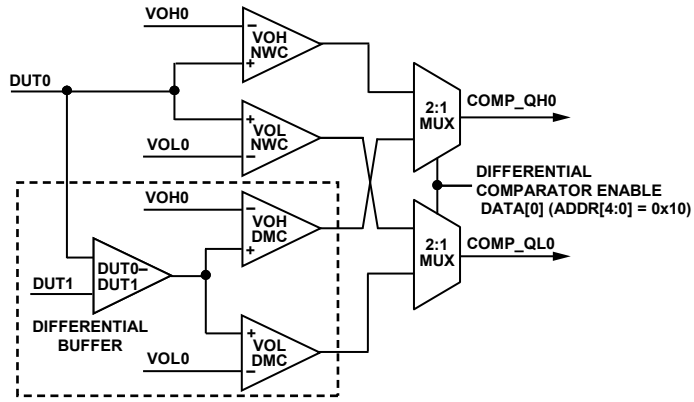

Figure 76. HVOUT Driver Output Stage

07279-080



NOTES
1. DIFFERENTIAL COMPARATOR ONLY ON CHANNEL 0.

Figure 77. Comparator Block Diagram

07279-081

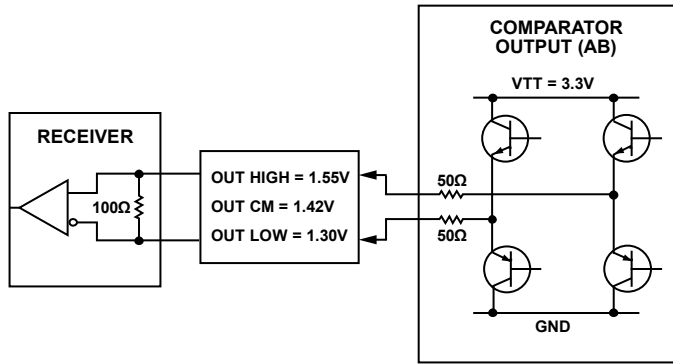
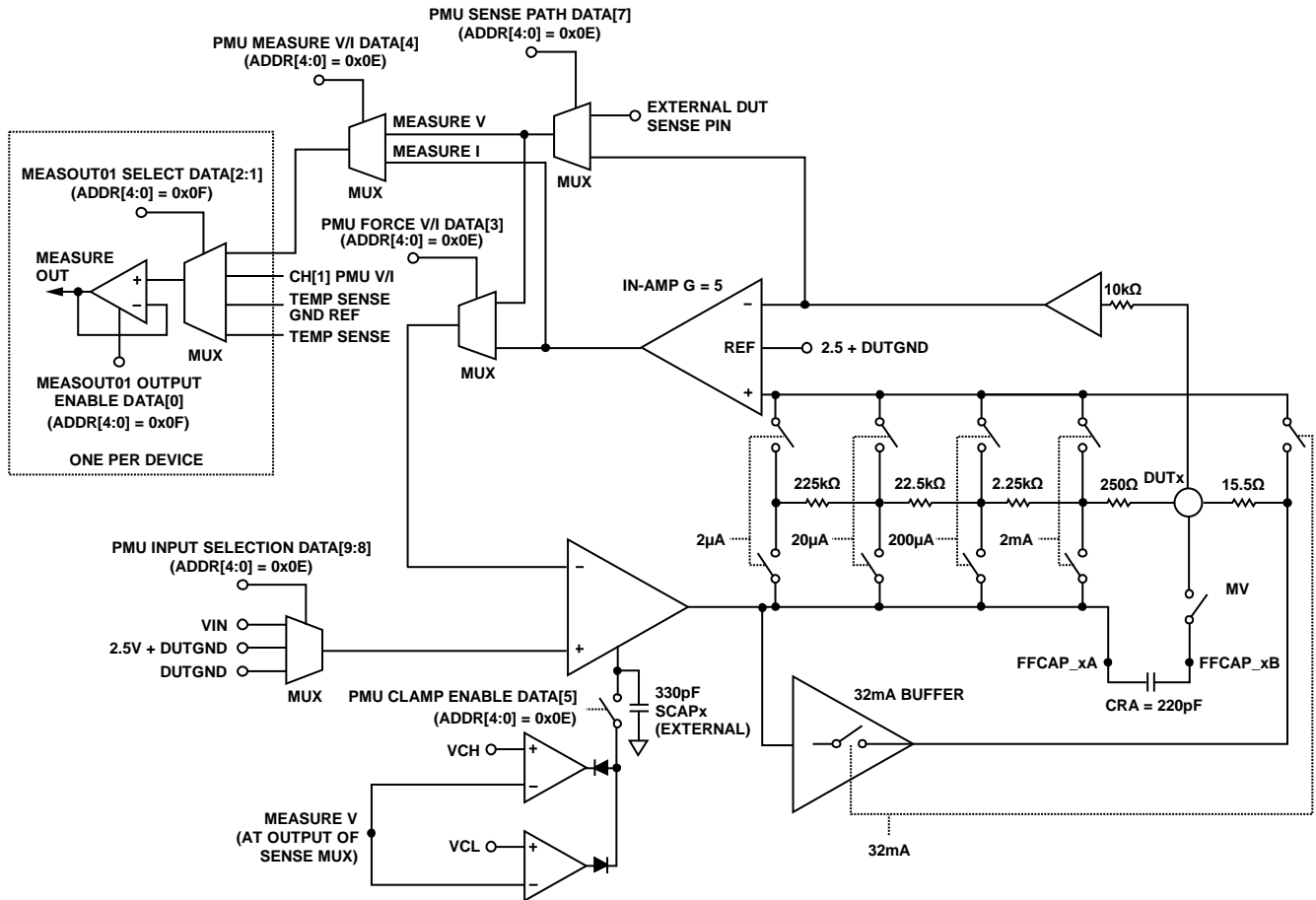

Figure 78. Comparator Output Scheme

07279-082



NOTES

1. SWITCHES CONNECTED WITH DOTTED LINES REPRESENT PMU RANGE DATA[2:0] (ADDR[4:0] = 0x0E); WHEN PMU ENABLE DATA[2] = 0 (ADDR[4:0] = 0x0C), ALL SWITCHES OPEN AND PMU POWERS DOWN.
2. THE EXTERNAL SENSE PATH MUST CLOSE THE LOOP TO ENABLE THE CLAMPS TO OPERATE CORRECTLY.
3. 32mA RANGE HAS ITS OWN OUTPUT BUFFER.
4. 32mA BUFFER TRISTATES WHEN NOT IN USE.

Figure 79. PMU Block Diagram

07275-083

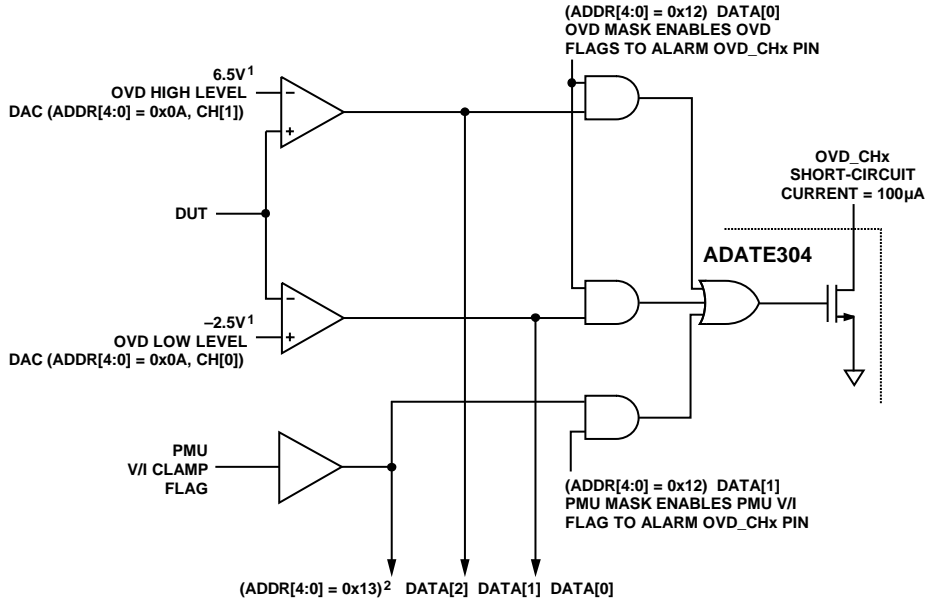

¹THE OVD HIGH/LOW LEVEL DAC IS SHARED BY EACH CHANNEL; THEREFORE, ONLY ONE OVD HIGH/LOW VOLTAGE LEVEL CAN BE SET PER CHIP. THE OVD DACs PROVIDE A VOLTAGE RANGE OF -3V TO +7V. THE RECOMMENDED HIGH/LOW SETTINGS ARE +6.5V/-2.5V. (THESE VALUES NEED TO BE PROGRAMMED BY THE USER UPON STARTUP/RESET.)
²THIS IS A READ ONLY REGISTER THAT ALLOWS THE USER TO DETERMINE THE CAUSE OF THE ACTIVE OVD FLAG.

Figure 80. OVD Block Diagram

07275-084

OUTLINE DIMENSIONS

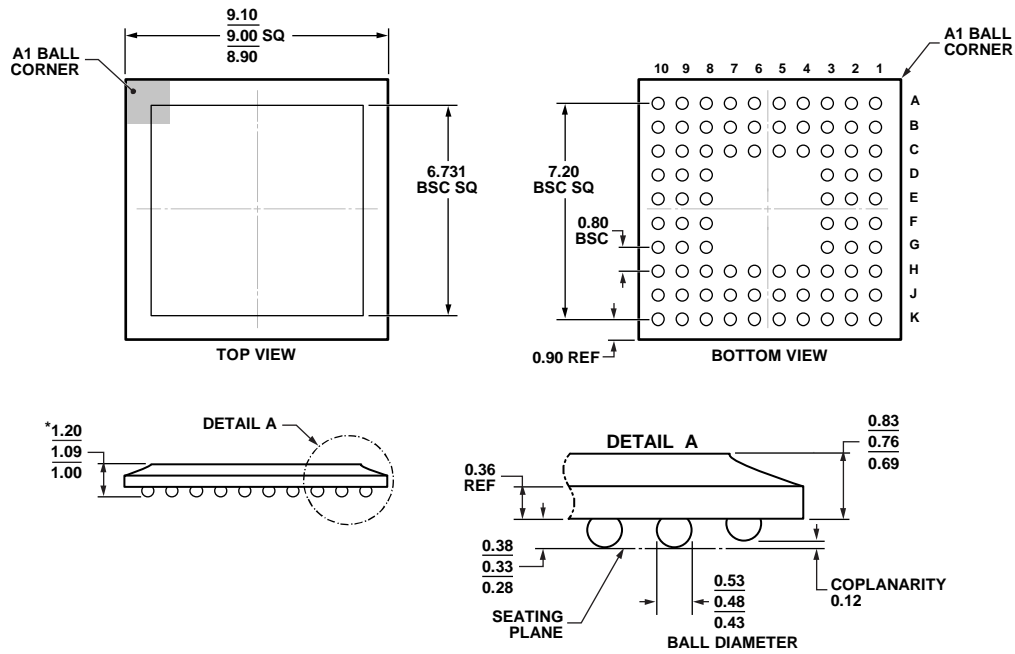

*COMPLIANT TO JEDEC STANDARDS MO-219 WITH EXCEPTION TO PACKAGE HEIGHT.

Figure 81. 84-Ball Chip Scale Package Ball Grid Array [CSP_BGA] (BC-84-2)

Dimensions shown in millimeters

07-06-2012-A

ORDERING GUIDE

Model ¹	Temperature Range	Package Description	Package Option
ADATE304BBCZ	-40°C to +85°C	84-Ball Chip Scale Package Ball Grid Array [CSP_BGA]	BC-84-2

¹Z = RoHS Compliant Part.



Компания «ЭлектроПласт» предлагает заключение долгосрочных отношений при поставках импортных электронных компонентов на взаимовыгодных условиях!

Наши преимущества:

- Оперативные поставки широкого спектра электронных компонентов отечественного и импортного производства напрямую от производителей и с крупнейших мировых складов;
- Поставка более 17-ти миллионов наименований электронных компонентов;
- Поставка сложных, дефицитных, либо снятых с производства позиций;
- Оперативные сроки поставки под заказ (от 5 рабочих дней);
- Экспресс доставка в любую точку России;
- Техническая поддержка проекта, помощь в подборе аналогов, поставка прототипов;
- Система менеджмента качества сертифицирована по Международному стандарту ISO 9001;
- Лицензия ФСБ на осуществление работ с использованием сведений, составляющих государственную тайну;
- Поставка специализированных компонентов (Xilinx, Altera, Analog Devices, Intersil, Interpoint, Microsemi, Aeroflex, Peregrine, Syfer, Eurofarad, Texas Instrument, Miteq, Cobham, E2V, MA-COM, Hittite, Mini-Circuits, General Dynamics и др.);

Помимо этого, одним из направлений компании «ЭлектроПласт» является направление «Источники питания». Мы предлагаем Вам помощь Конструкторского отдела:

- Подбор оптимального решения, техническое обоснование при выборе компонента;
- Подбор аналогов;
- Консультации по применению компонента;
- Поставка образцов и прототипов;
- Техническая поддержка проекта;
- Защита от снятия компонента с производства.



Как с нами связаться

Телефон: 8 (812) 309 58 32 (многоканальный)

Факс: 8 (812) 320-02-42

Электронная почта: org@eplast1.ru

Адрес: 198099, г. Санкт-Петербург, ул. Калинина, дом 2, корпус 4, литера А.