

## Low Dropout Voltage Regulator

### ■ GENERAL DESCRIPTION

The NJM2878 is a 150mA output low dropout voltage regulator with ON/OFF control.

Advanced bipolar technology achieves low noise, high ripple rejection, high accuracy and low quiescent current.

Small packaging (SC-88A/SC82AB) and very small packaging (ESON4), 0.47 $\mu$ F small decoupling capacitor and built-in noise bypass capacitor make the NJM2878 suitable for space conscious applications.

### ■ PACKAGE OUTLINE

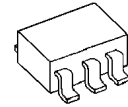

NJM2878F3

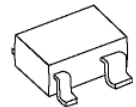

NJM2878F4

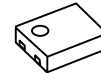

NJM2878KF1

### ■ FEATURES

- High Ripple Rejection      75dB typ. (f=1kHz Vo=3V version)
- Output Noise Voltage      Vno=45 $\mu$ Vrms typ.
- Output capacitor with 0.47 $\mu$ F ceramic capacitor(Vo $\geq$ 2.7V Version)
- Output Current              Io(max.)=150mA
- High Precision Output      Vo  $\pm$ 1.0%
- Low Dropout Voltage      0.10V typ. (Io=60mA)
- ON/OFF Control              (Active High)
- Internal Thermal Overload Protection
- Internal Over Current Protection
- Bipolar Technology
- Package Outline              SC88A(NJM2878F3) / SC82AB(NJM2878F4) / ESON4-F1(NJM2878KF1)

### ■ PIN CONFIGURATION

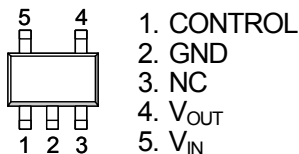

NJM2878F3

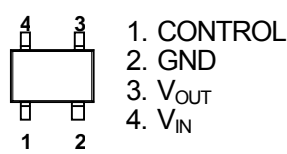

NJM2878F4

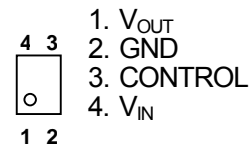

NJM2878KF1

### ■ EQUIVALENT CIRCUIT

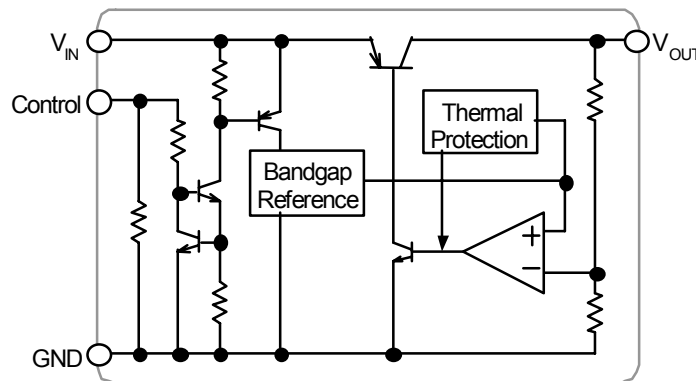

# NJM2878

## ■ OUTPUT VOLTAGE RANK LIST

The WHITE column shows applicable Voltage Rank(s)

Device Name	V <sub>out</sub>	Device Name	V <sub>out</sub>
NJM2878F3/F4-15	1.5V	NJM2878F3/F4-35	3.5V
NJM2878F3/F4-16	1.6V	NJM2878F3/F4-36	3.6V
NJM2878F3/F4-17	1.7V	NJM2878F3/F4-37	3.7V
NJM2878F3/F4-18	1.8V	NJM2878F3/F4-38	3.8V
NJM2878F3/F4-19	1.9V	NJM2878F3/F4-39	3.9V
NJM2878F3/F4-02	2.0V	NJM2878F3/F4-04	4.0V
NJM2878F3/F4-21	2.1V	NJM2878F3/F4-41	4.1V
NJM2878F3/F4-22	2.2V	NJM2878F3-42	4.2V
NJM2878F3/F4-23	2.3V	NJM2878F3-43	4.3V
NJM2878F3/F4-24	2.4V	NJM2878F3/F4-44	4.4V
NJM2878F3/F4-25	2.5V	NJM2878F3/F4-45	4.5V
NJM2878F3/F4-26	2.6V	NJM2878F3/F4-46	4.6V
NJM2878F3/F4-27	2.7V	NJM2878F3/F4-47	4.7V
NJM2878F3/F4-28	2.8V	NJM2878F3/F4-48	4.8V
NJM2878F3/F4-29	2.9V	NJM2878F3/F4-49	4.9V
NJM2878F3/F4-03	3.0V	NJM2878F3/F4-05	5.0V
NJM2878F3/F4-31	3.1V		
NJM2878F3/F4-32	3.2V		
NJM2878F3/F4-33	3.3V		
NJM2878F3/F4-34	3.4V		

The WHITE column shows applicable Voltage Rank(s)

Device Name	V <sub>out</sub>	Device Name	V <sub>out</sub>
NJM2878KF1-15	1.5V	NJM2878KF1-35	3.5V
NJM2878KF1-16	1.6V	NJM2878KF1-36	3.6V
NJM2878KF1-17	1.7V	NJM2878KF1-37	3.7V
NJM2878KF1-18	1.8V	NJM2878KF1-38	3.8V
NJM2878KF1-19	1.9V	NJM2878KF1-39	3.9V
NJM2878KF1-02	2.0V	NJM2878KF1-04	4.0V
NJM2878KF1-21	2.1V	NJM2878KF1-41	4.1V
NJM2878KF1-22	2.2V	NJM2878KF1-42	4.2V
NJM2878KF1-23	2.3V	NJM2878KF1-43	4.3V
NJM2878KF1-24	2.4V	NJM2878KF1-44	4.4V
NJM2878KF1-25	2.5V	NJM2878KF1-45	4.5V
NJM2878KF1-26	2.6V	NJM2878KF1-46	4.6V
NJM2878KF1-27	2.7V	NJM2878KF1-47	4.7V
NJM2878KF1-28	2.8V	NJM2878KF1-48	4.8V
NJM2878KF1-29	2.9V	NJM2878KF1-49	4.9V
NJM2878KF1-03	3.0V	NJM2878KF1-05	5.0V
NJM2878KF1-31	3.1V		
NJM2878KF1-32	3.2V		
NJM2878KF1-33	3.3V		
NJM2878KF1-34	3.4V		

## ■ ABSOLUTE MAXIMUM RATINGS (Ta=25°C)

PARAMETER	SYMBOL	RATINGS	UNIT
Input Voltage	V <sub>IN</sub>	+10	V
Control Voltage	V <sub>CONT</sub>	+10	V
Power Dissipation	P <sub>D</sub>	SC88A/SC82AB	250(*1)
		ESON4	150(*2)
			800(*3)
Operating Temperature	T <sub>opr</sub>	-40 ~ +85	°C
Storage Temperature	T <sub>stg</sub>	-40 ~ +125	°C

(\*1): Mounted on glass epoxy board based on EIA/JEDEC. (114.3 × 76.2 × 1.6mm: 2Layers FR-4)

(\*2): Mounted on glass epoxy board based on EIA/JEDEC STANDARD. (101.5×114.5×1.6mm: 2Layers FR-4)

(\*3): Mounted on glass epoxy board based on EIA/JEDEC STANDARD. (101.5 × 114.5 × 1.6mm: 4Layers FR-4,  
Internal foil area size: 99.5 × 99.5mm, Applying a thermal via hole to a board based on JEDEC standard JESD51-5)

## ■ Operating voltage

V<sub>IN</sub>=+2.3 ~ +9V (In case of Vo<2.1V version)

## ■ ELECTRICAL CHARACTERISTICS

(V<sub>IN</sub>=Vo+1V, C<sub>IN</sub>=0.1μF, Co=0.47μF: Vo≥2.7V (Co=1.0μF : 1.8V<Vo≤2.6V, Co=2.2μF : Vo≤1.8V), Ta=25°C)

PARAMETER	SYMBOL	TEST CONDITION	MIN.	TYP.	MAX.	UNIT
Output Voltage	V <sub>o</sub>	I <sub>o</sub> =30mA	-1.0%	-	+1.0%	V
Quiescent Current	I <sub>Q</sub>	I <sub>o</sub> =0mA, except I <sub>cont</sub>	-	140	195	μA
Quiescent Current at Control OFF	I <sub>Q(OFF)</sub>	V <sub>CONT</sub> =0V	-	-	100	nA
Output Current	I <sub>o</sub>	V <sub>o</sub> - 0.3V	150	200	-	mA
Line Regulation	ΔV <sub>o</sub> /ΔV <sub>IN</sub>	V <sub>IN</sub> =Vo+1V ~ Vo+6V(V <sub>o</sub> ≤3V), V <sub>IN</sub> =Vo+1V ~ 9V(V <sub>o</sub> >3V), I <sub>o</sub> =30mA	-	-	0.10	%/V
Load Regulation	ΔV <sub>o</sub> /ΔI <sub>o</sub>	I <sub>o</sub> =0 ~ 100mA	-	-	0.016	%/mA
Dropout Voltage (*4)	ΔV <sub>L-O</sub>	I <sub>o</sub> =60mA	-	0.10	0.18	V
Ripple Rejection	RR	e <sub>in</sub> =200mVrms, f=1kHz, I <sub>o</sub> =10mA, Vo=3V version	-	75	-	dB
Average Temperature Coefficient of Output Voltage	ΔV <sub>o</sub> /ΔTa	Ta=0 ~ +85°C, I <sub>o</sub> =10mA	-	± 50	-	ppm/°C
Output Noise Voltage	V <sub>NO1</sub>	f=10Hz~80kHz, I <sub>o</sub> =10mA, Vo=3V Version	-	45	-	μVrms
Control Current	I <sub>CONT</sub>	V <sub>CONT</sub> =1.6V	-	3	12	μA
Control Voltage for ON-state	V <sub>CONT(ON)</sub>		1.6	-	-	V
Control Voltage for OFF-state	V <sub>CONT(OFF)</sub>		-	-	0.6	V
Input Voltage	V <sub>IN</sub>		-	-	9	V

(\*4): The output voltage excludes under 2.1V.

The above specification is a common specification for all output voltages.

Therefore, it may be different from the individual specification for a specific output voltage.

# NJM2878

## TEST CIRCUIT

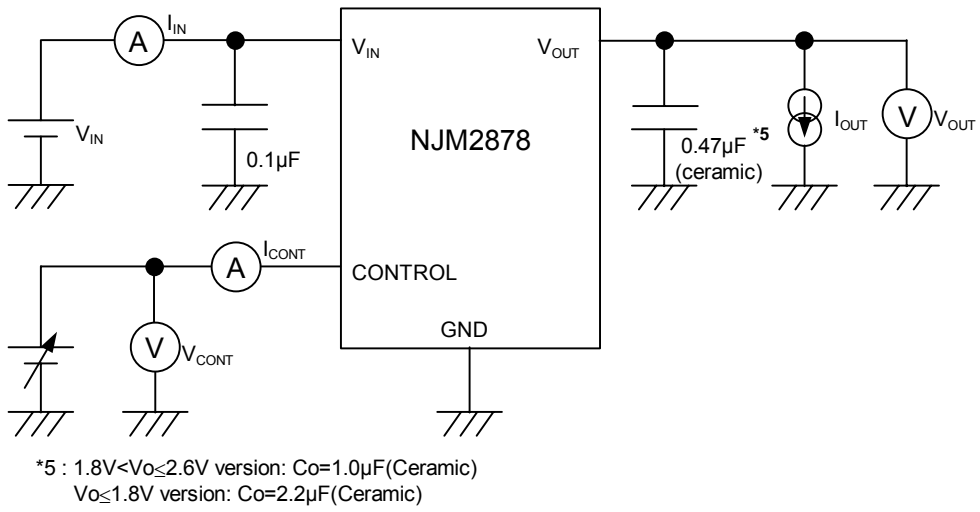

## TYPICAL APPLICATION

① In the case where ON/OFF Control is not required:

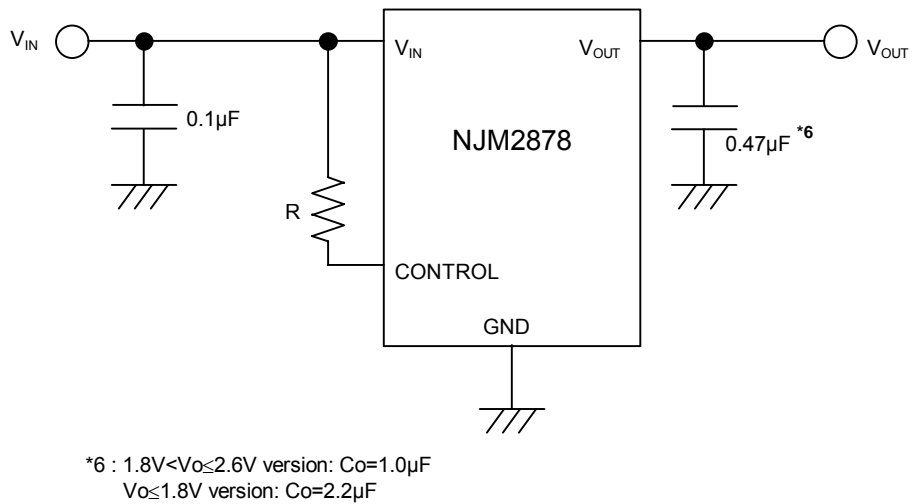

Connect control terminal to  $V_{IN}$  terminal

## ② In use of ON/OFF CONTROL:

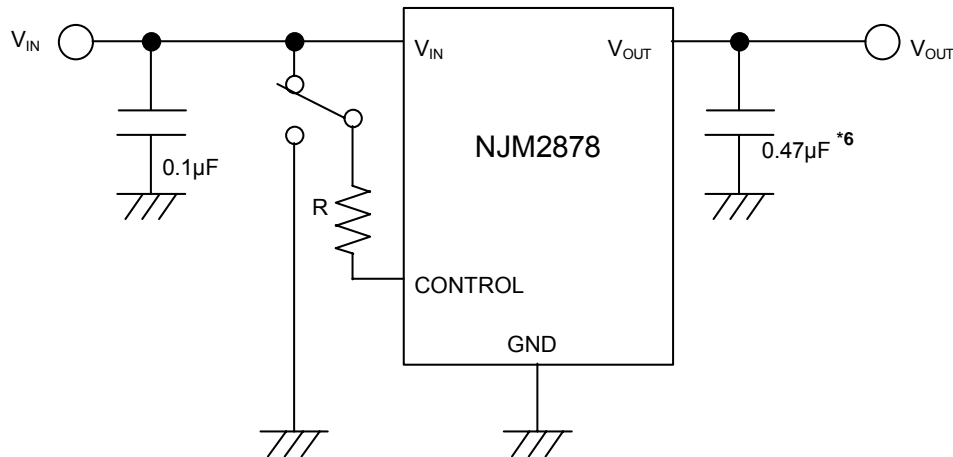

\*6 : 1.8V <  $V_O$  ≤ 2.6V version:  $C_O = 1.0\mu\text{F}$   
 $V_O \leq 1.8\text{V}$  version:  $C_O = 2.2\mu\text{F}$

State of control terminal:

- "H" → output is enabled.
- "L" or "open" → output is disabled.

### \*Input Capacitance $C_{IN}$

Input Capacitance  $C_{IN}$  is required to prevent oscillation and reduce power supply ripple for applications with high power supply impedance or a long power supply line.

You should use the  $C_{IN}$  value of  $0.1\mu\text{F}$  larger to avoid the problem.

$C_{IN}$  should connect between GND and  $V_{IN}$  as **shortest path** as possible.

### \*In the case of using a resistance "R" between $V_{IN}$ and control.

The current flow into the control terminal while the IC is ON state ( $I_{CONT}$ ) can be reduced when a pull up resistance "R" is inserted between  $V_{IN}$  and the control terminal.

The minimum control voltage for ON state ( $V_{CONT(ON)}$ ) is increased due to the voltage drop caused by  $I_{CONT}$  and the resistance "R". The  $I_{CONT}$  is temperature dependence as shown in the "Control Current vs. Temperature" characteristics. Therefore, the resistance "R" should be carefully selected to ensure the control voltage exceeds the  $V_{CONT(ON)}$  over the required temperature range.

### \*Output Capacitance $C_O$

Output capacitor ( $C_O$ ) **will be** required for a phase compensation of the internal error amplifier.

The capacitance and the equivalent series resistance (ESR) influence to **stable operation** of the regulator.

This product is designed to work with a low ESR capacitor ( $C_O$ ). However use of recommended capacitance or larger value is effective for stable operation.

Use of a smaller  $C_O$  may cause excess output noise or oscillation of the regulator due to lack of the phase compensation.

Therefore use  $C_O$  with the recommended capacitance or **larger** value and connect between  $V_O$  terminal and GND terminal with shortest path. The recommended capacitance depends on the output voltage rank. Low voltage regulator requires **larger** value  $C_O$ . Thus, check the recommended capacitance for each output voltage rank.

Use of a larger  $C_O$  reduces output noise and ripple output, and also improves output transient response against rapid load change.

# NJM2878

## ■ POWER DISSIPATION vs. AMBIENT TEMPERATURE (SC-88A/SC82AB)

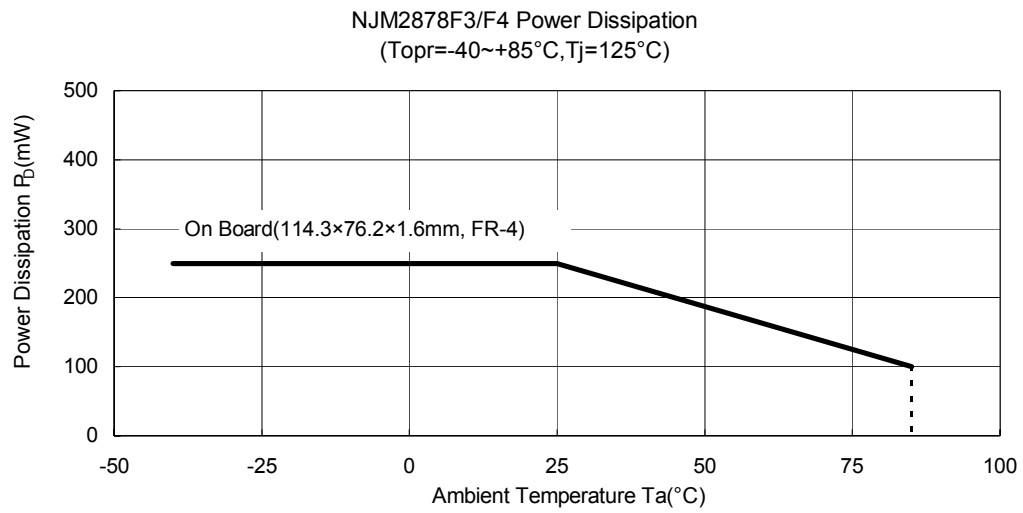

## TYPICAL CHARACTERISTICS

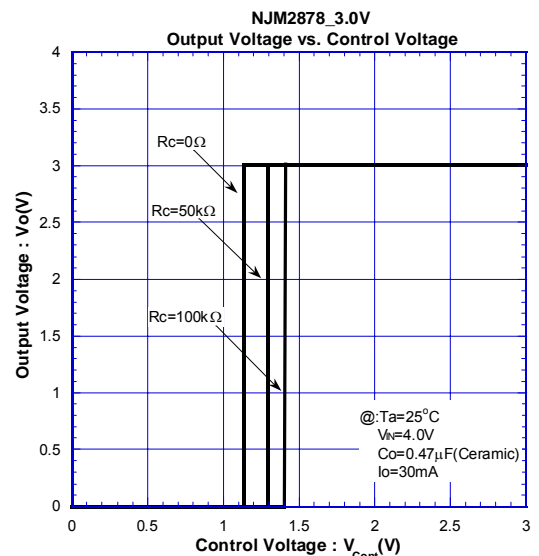
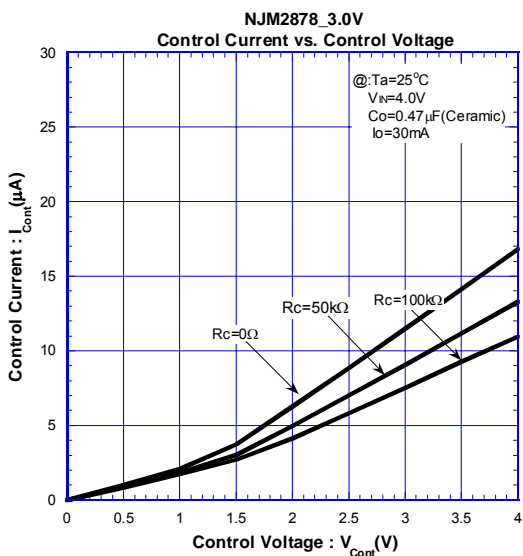
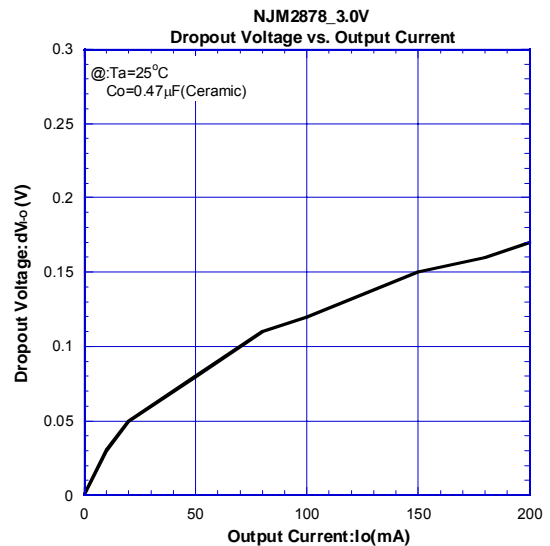
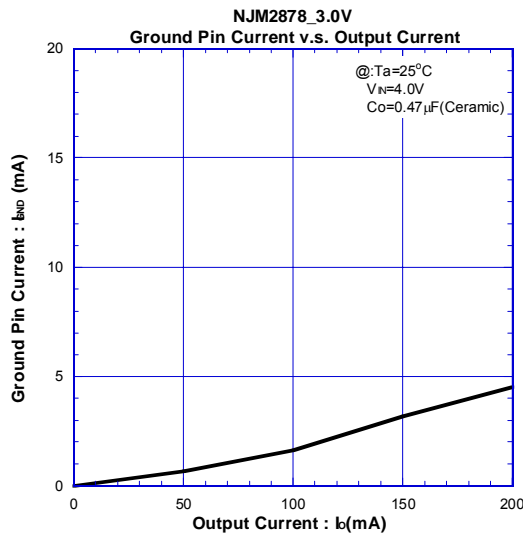
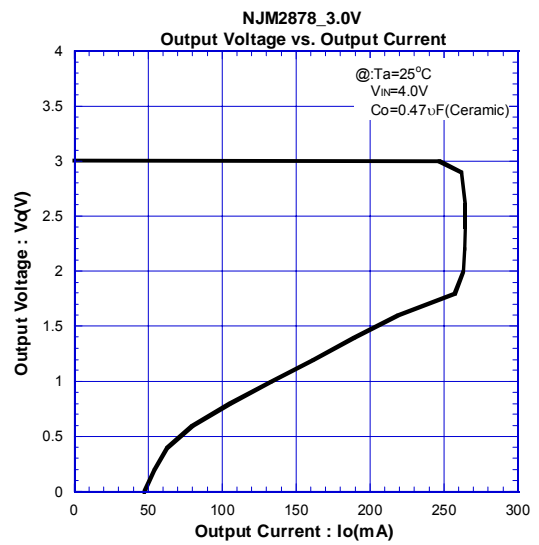
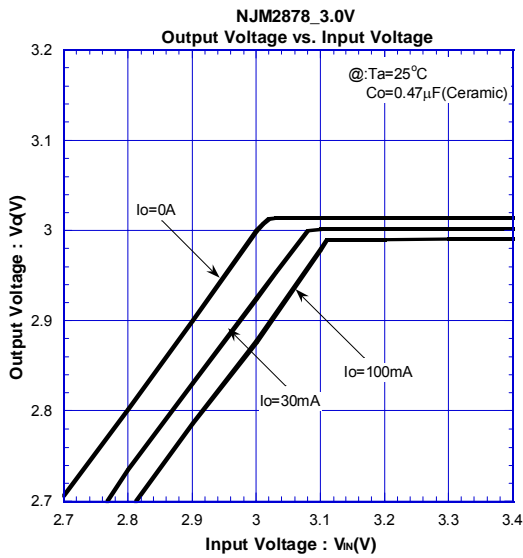

# NJM2878

## ■ TYPICAL CHARACTERISTICS

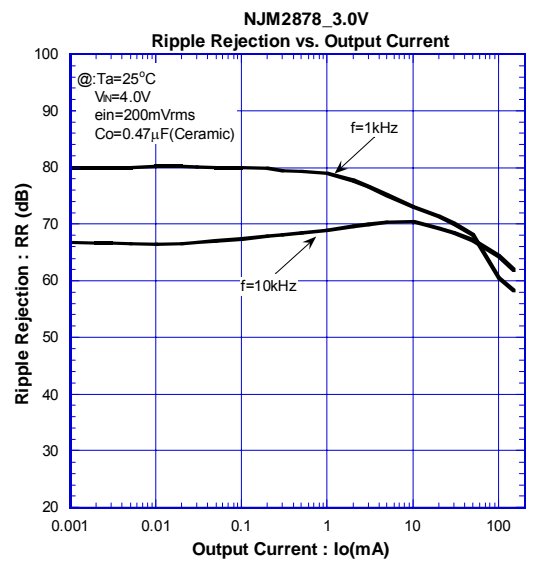
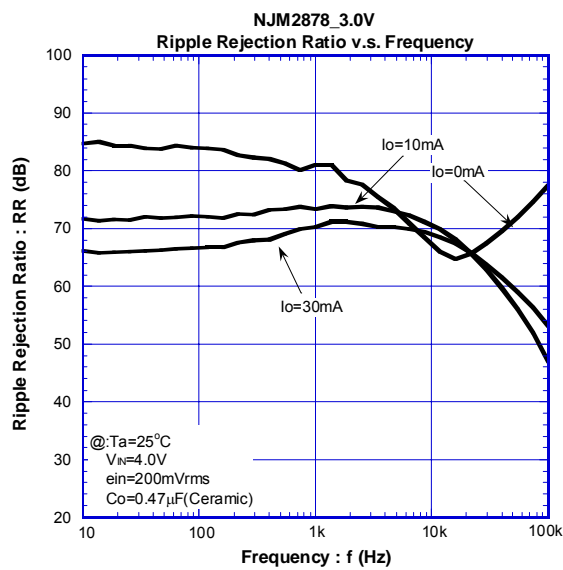
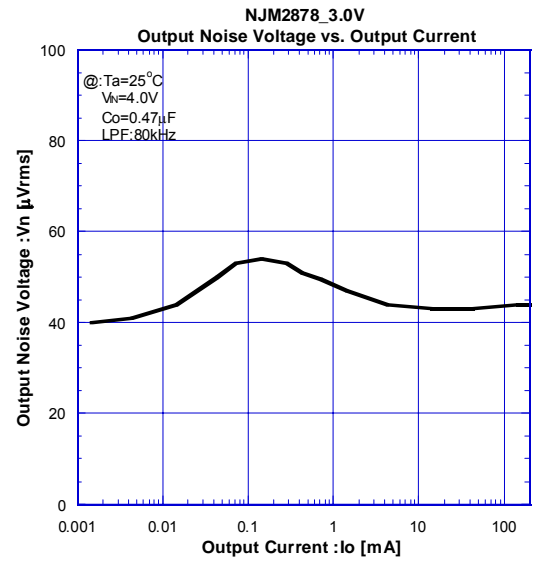
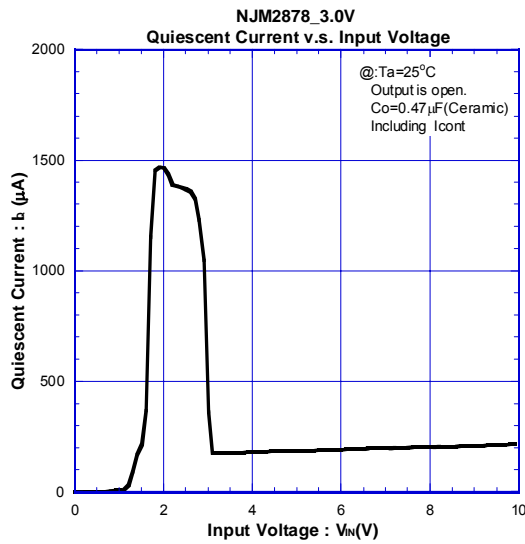
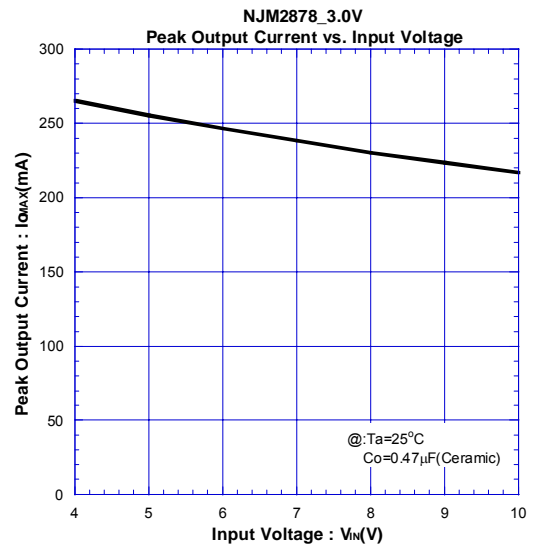
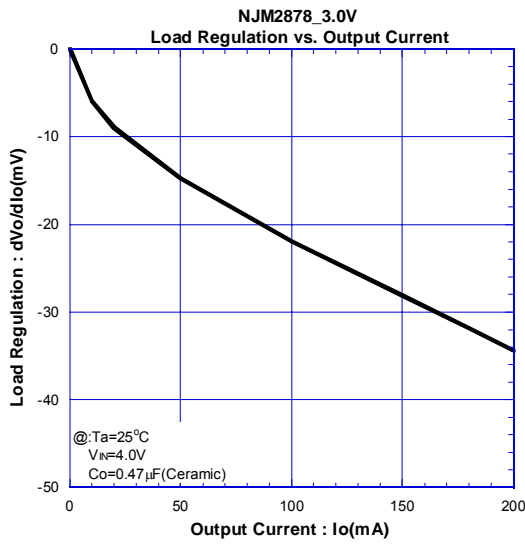



■ TYPICAL CHARACTERISTICS

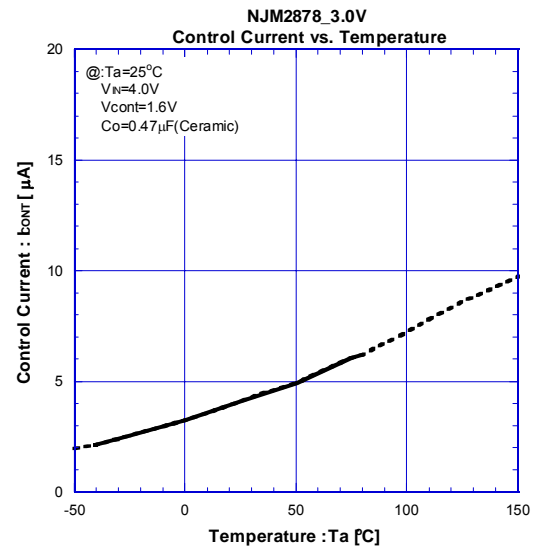
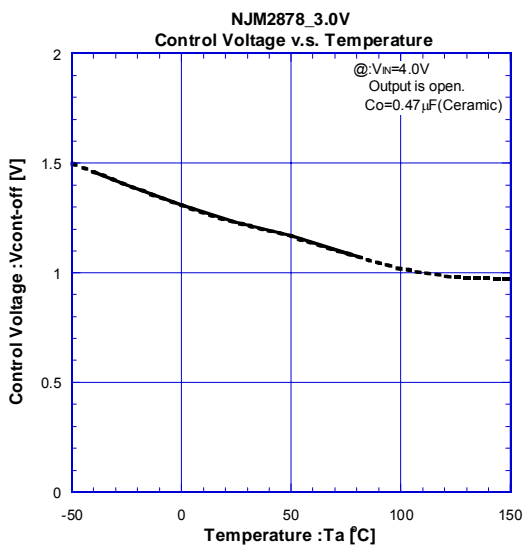
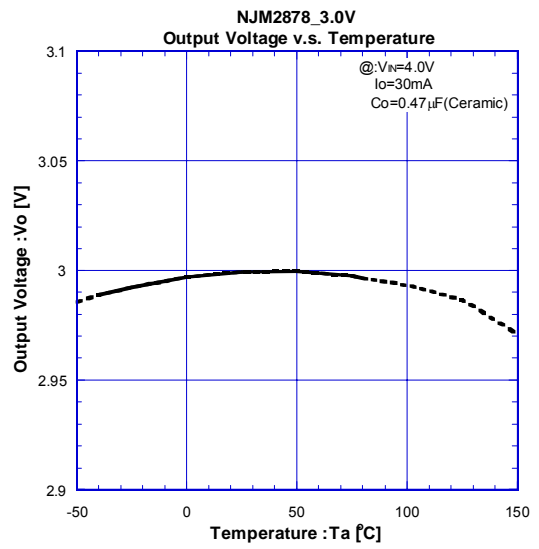
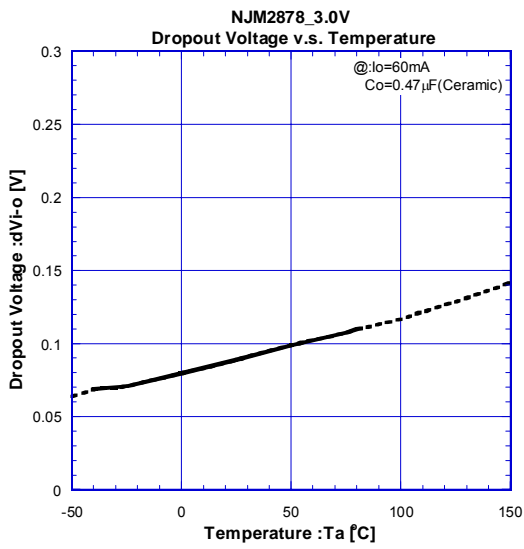
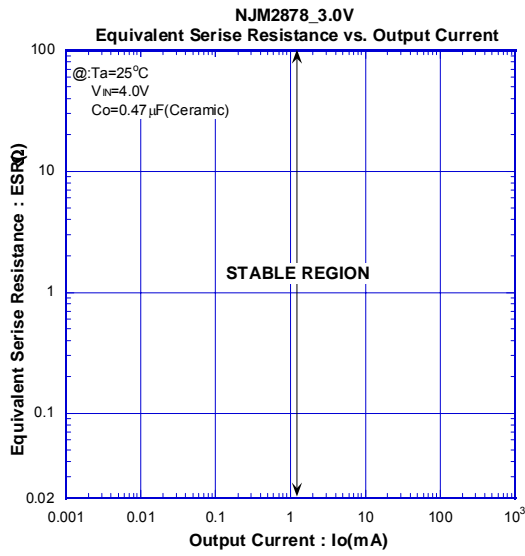

## TYPICAL CHARACTERISTICS

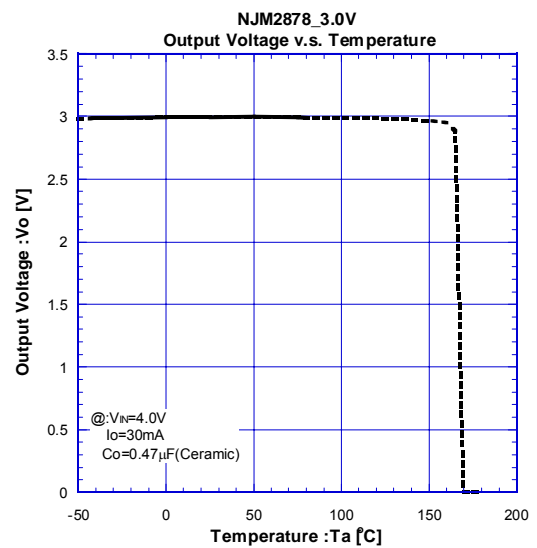
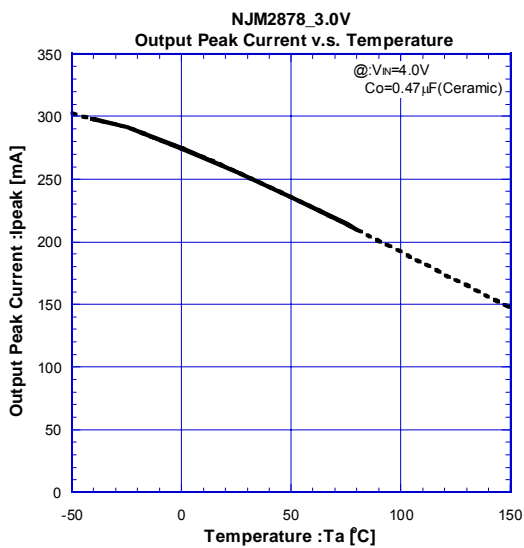
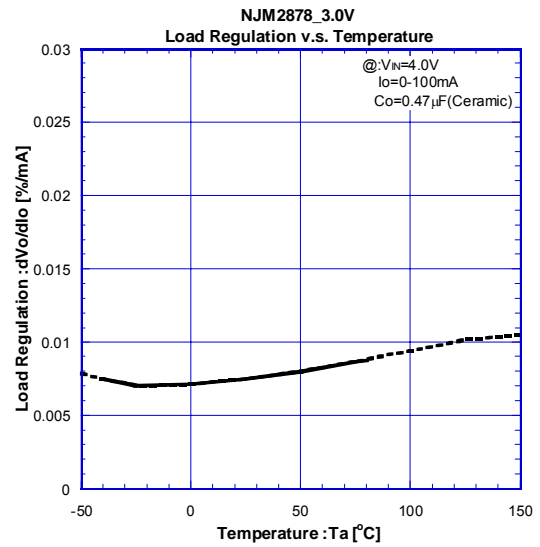
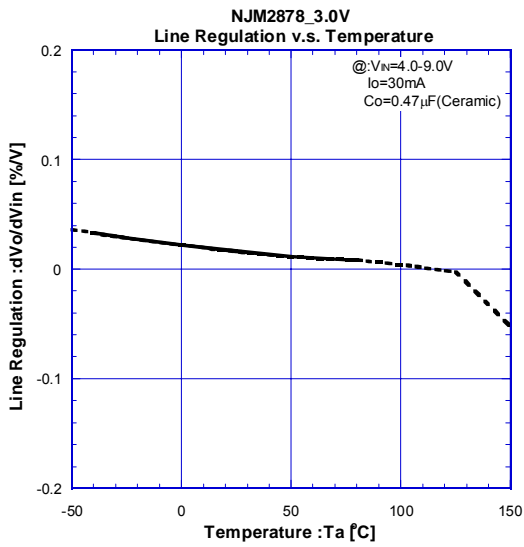
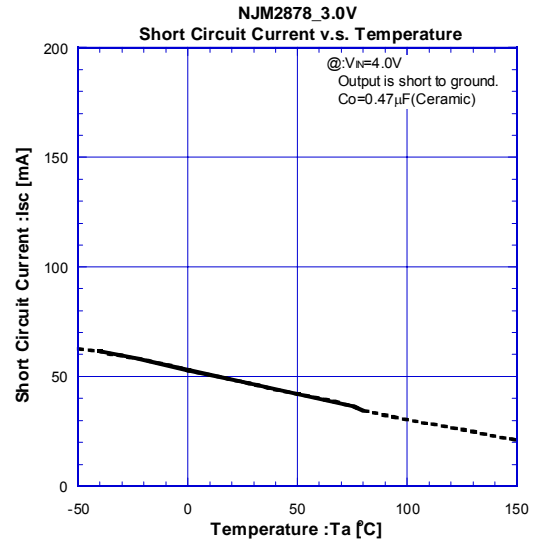
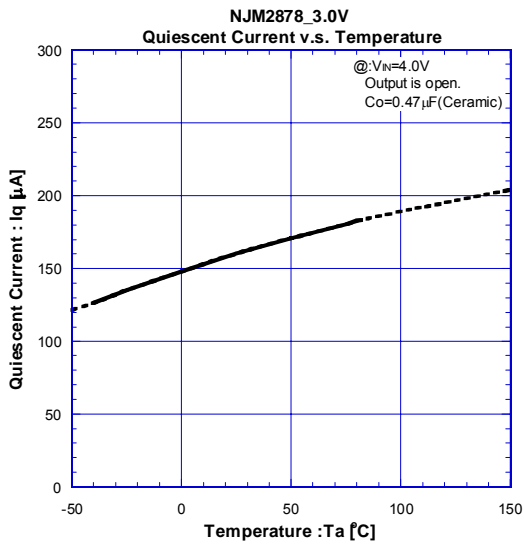

## ■ TYPICAL CHARACTERISTICS

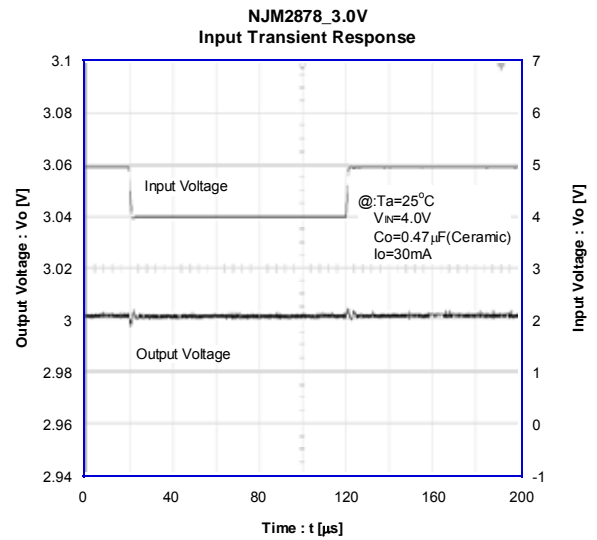
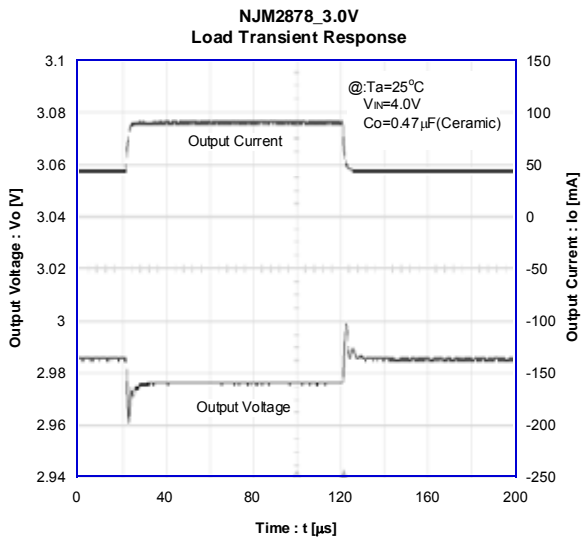
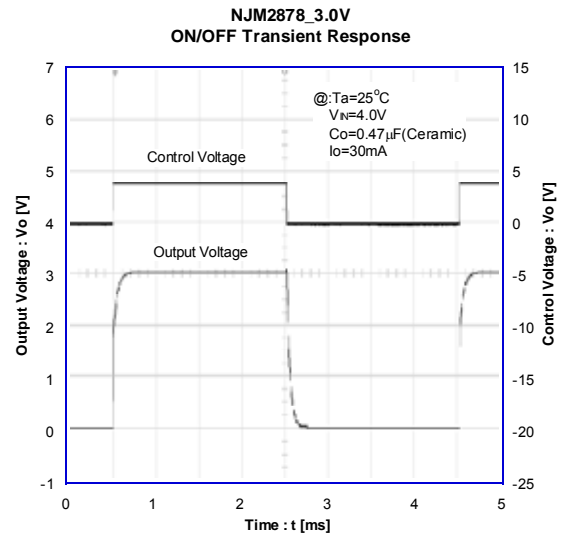
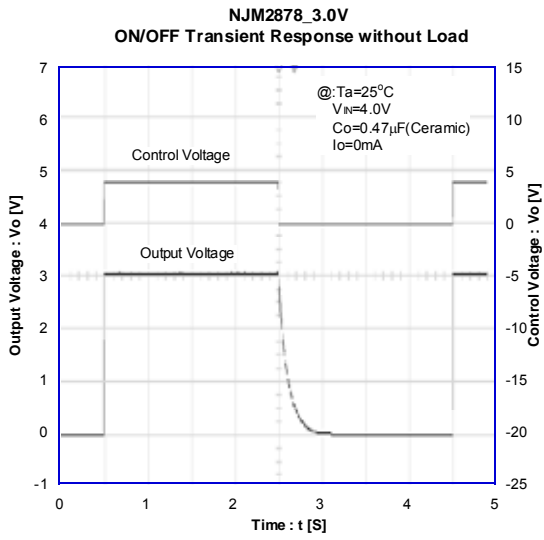

**[CAUTION]**  
The specifications on this databook are only given for information, without any guarantee as regards either mistakes or omissions. The application circuits in this databook are described only to show representative usages of the product and not intended for the guarantee or permission of any right including the industrial rights.

# Mouser Electronics

Authorized Distributor

Click to View Pricing, Inventory, Delivery & Lifecycle Information:

[NJR:](#)

[NJM2878F3-05-TE2](#) [NJM2878F4-TE1](#) [NJM2878F3-33-TE2](#)



Компания «ЭлектроПласт» предлагает заключение долгосрочных отношений при поставках импортных электронных компонентов на взаимовыгодных условиях!

Наши преимущества:

- Оперативные поставки широкого спектра электронных компонентов отечественного и импортного производства напрямую от производителей и с крупнейших мировых складов;
- Поставка более 17-ти миллионов наименований электронных компонентов;
- Поставка сложных, дефицитных, либо снятых с производства позиций;
- Оперативные сроки поставки под заказ (от 5 рабочих дней);
- Экспресс доставка в любую точку России;
- Техническая поддержка проекта, помощь в подборе аналогов, поставка прототипов;
- Система менеджмента качества сертифицирована по Международному стандарту ISO 9001;
- Лицензия ФСБ на осуществление работ с использованием сведений, составляющих государственную тайну;
- Поставка специализированных компонентов (Xilinx, Altera, Analog Devices, Intersil, Interpoint, Microsemi, Aeroflex, Peregrine, Syfer, Eurofarad, Texas Instrument, Miteq, Cobham, E2V, MA-COM, Hittite, Mini-Circuits, General Dynamics и др.);

Помимо этого, одним из направлений компании «ЭлектроПласт» является направление «Источники питания». Мы предлагаем Вам помощь Конструкторского отдела:

- Подбор оптимального решения, техническое обоснование при выборе компонента;
- Подбор аналогов;
- Консультации по применению компонента;
- Поставка образцов и прототипов;
- Техническая поддержка проекта;
- Защита от снятия компонента с производства.



#### Как с нами связаться

**Телефон:** 8 (812) 309 58 32 (многоканальный)

**Факс:** 8 (812) 320-02-42

**Электронная почта:** [org@eplast1.ru](mailto:org@eplast1.ru)

**Адрес:** 198099, г. Санкт-Петербург, ул. Калинина, дом 2, корпус 4, литера А.