

### Features

- 8mm diameter big lamp.
- Reliable and rugged.
- Long life-solid state reliability.
- RoHS compliant.

### Description

The Super Bright Red source color devices are made with Gallium Aluminum Arsenide Red Light Emitting Diode.

### Package Dimensions

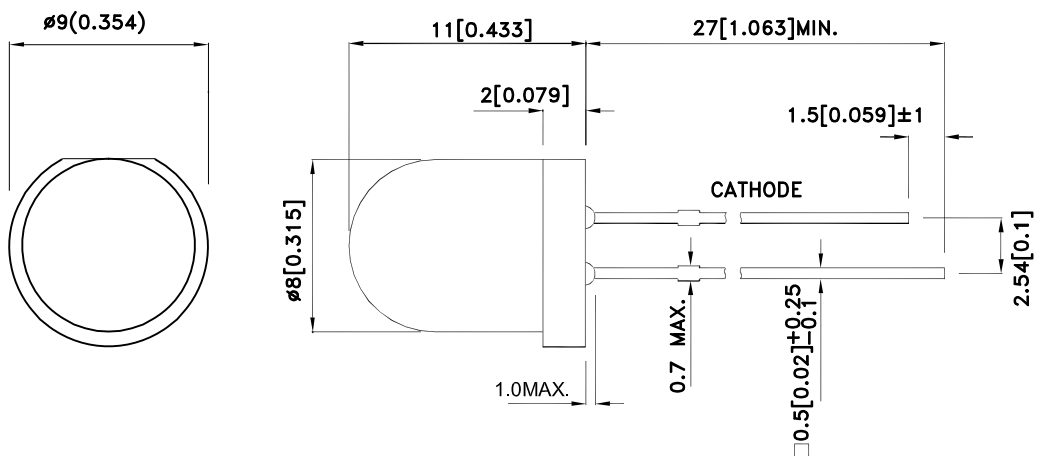

#### Notes:

1. All dimensions are in millimeters (inches).
2. Tolerance is  $\pm 0.25(0.01")$  unless otherwise noted.
3. Lead spacing is measured where the leads emerge from the package.
4. The specifications, characteristics and technical data described in the datasheet are subject to change without prior notice.



## Selection Guide

Part No.	Dice	Lens Type	Iv (mcd) [2] @ 20mA		Viewing Angle [1]
			Min.	Typ.	2θ1/2
WP793SRC/D	Super Bright Red (GaAlAs)	Water Clear	1300	2000	15°
			*500	*800	

Notes:

1.  $\theta_{1/2}$  is the angle from optical centerline where the luminous intensity is 1/2 of the optical peak value.
2. Luminous intensity/ luminous Flux: +/- 15%.
- \* Luminous intensity value is traceable to the CIE127-2007 compliant national standards.

## Electrical / Optical Characteristics at TA=25°C

Symbol	Parameter	Device	Typ.	Max.	Units	Test Conditions
$\lambda_{peak}$	Peak Wavelength	Super Bright Red	655		nm	I <sub>F</sub> =20mA
$\lambda_D$ [1]	Dominant Wavelength	Super Bright Red	640		nm	I <sub>F</sub> =20mA
$\Delta\lambda_{1/2}$	Spectral Line Half-width	Super Bright Red	20		nm	I <sub>F</sub> =20mA
C	Capacitance	Super Bright Red	45		pF	V <sub>F</sub> =0V;f=1MHz
V <sub>F</sub> [2]	Forward Voltage	Super Bright Red	1.85	2.5	V	I <sub>F</sub> =20mA
I <sub>R</sub>	Reverse Current	Super Bright Red		10	uA	V <sub>R</sub> = 5V

Notes:

1. Wavelength: +/- 1nm.
2. Forward Voltage: +/- 0.1V.
3. Wavelength value is traceable to the CIE127-2007 compliant national standards.

## Absolute Maximum Ratings at TA=25°C

Parameter	Super Bright Red	Units
Power dissipation	75	mW
DC Forward Current	30	mA
Peak Forward Current [1]	155	mA
Reverse Voltage	5	V
Operating/Storage Temperature	-40°C To +85°C	
Lead Solder Temperature [2]	260°C For 3 Seconds	
Lead Solder Temperature [3]	260°C For 5 Seconds	

Notes:

1. 1/10 Duty Cycle, 0.1ms Pulse Width.
2. 2mm below package base.
3. 5mm below package base.

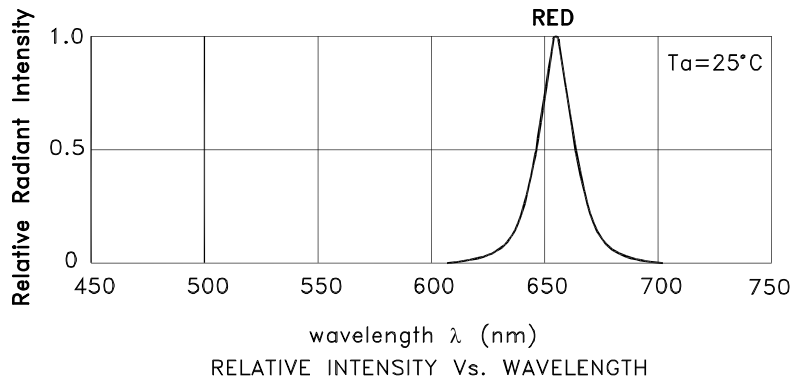

## Super Bright Red

## WP793SRC/D

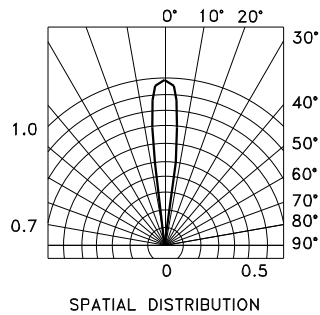
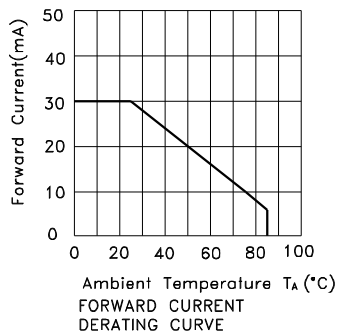
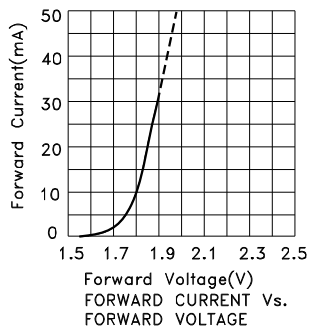

# Kingbright

## PACKING & LABEL SPECIFICATIONS

WP793SRC/D

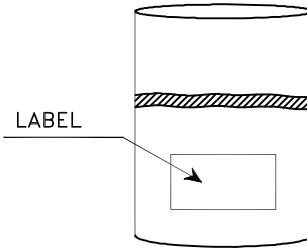
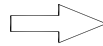
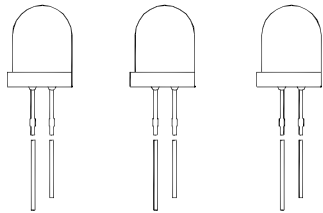

200PCS / BAG

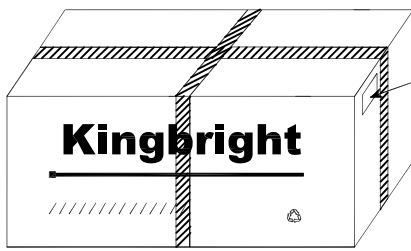

12.8K / 9# BOX

OUTSIDE LABEL

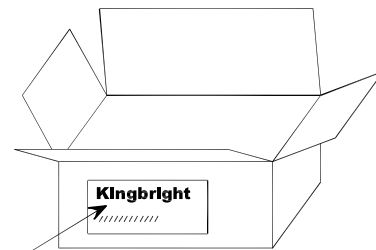

OUTSIDE LABEL

1.6K / 5# BOX

# Kingbright

P/NO: WP793xxx

QTY: 200 pcs

Q.C.

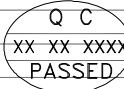

S/N: XXXX

CODE: XXX

LOT NO:



RoHS Compliant

## PRECAUTIONS

1. The lead pitch of the LED must match the pitch of the mounting holes on the PCB during component placement. Lead-forming may be required to insure the lead pitch matches the hole pitch. Refer to the figure below for proper lead forming procedures. (Fig. 1)



Fig.1

”○” Correct mounting method ”×” Incorrect mounting method

2. When soldering wire to the LED, use individual heat-shrink tubing to insulate the exposed leads to prevent accidental contact short-circuit. (Fig.2)
3. Use stand-offs (Fig.3) or spacers (Fig.4) to securely position the LED above the PCB.



Fig. 2

Fig. 3

Fig. 4

4. Maintain a minimum of 2mm clearance between the base of the LED lens and the first lead bend. (Fig. 5 and 6)
5. During lead forming, use tools or jigs to hold the leads securely so that the bending force will not be transmitted to the LED lens and its internal structures. Do not perform lead forming once the component has been mounted onto the PCB. (Fig. 7)

6. Do not bend the leads more than twice. (Fig. 8)



Fig. 5



Fig. 6

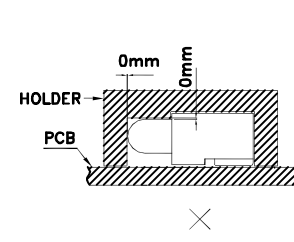
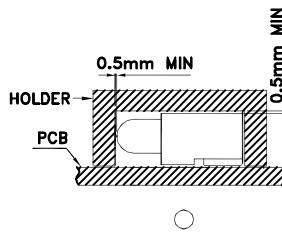
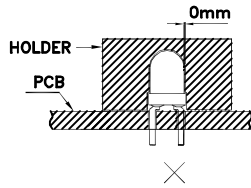
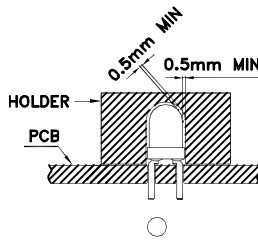

Fig. 7



Fig. 8

7. During soldering, component covers and holders should leave clearance to avoid placing damaging stress on the LED during soldering.



8. The tip of the soldering iron should never touch the lens epoxy.

9. Through-hole LEDs are incompatible with reflow soldering.

10. If the LED will undergo multiple soldering passes or face other processes where the part may be subjected to intense heat, please check with Kingbright for compatibility.

11. Recommended Wave Soldering Profiles:

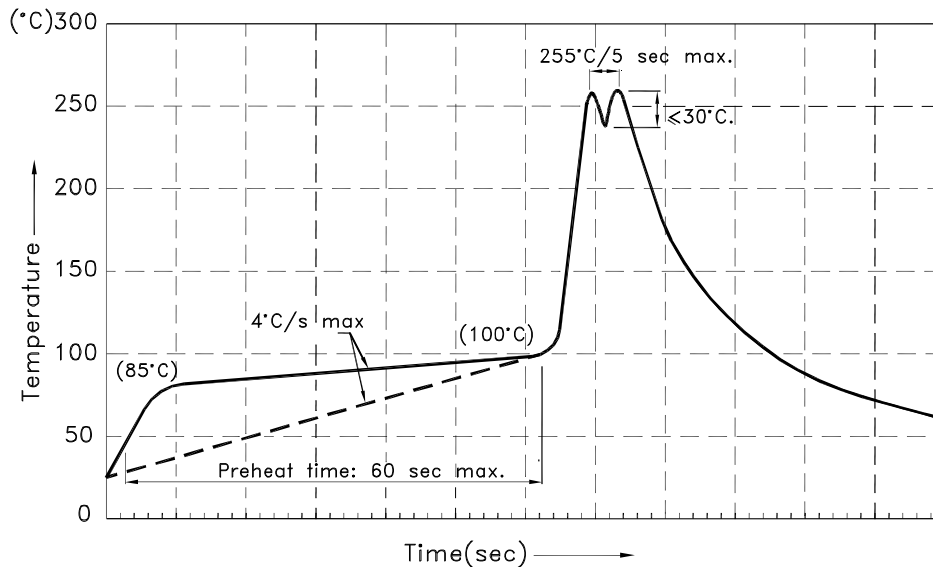

Notes:

1. Recommend pre-heat temperature of 105°C or less (as measured with a thermocouple attached to the LED pins) prior to immersion in the solder wave with a maximum solder bath temperature of 260°C
2. Peak wave soldering temperature between 245°C ~ 255°C for 3 sec (5 sec max).
3. Do not apply stress to the epoxy resin while the temperature is above 85°C.
4. Fixtures should not incur stress on the component when mounting and during soldering process.
5. SAC 305 solder alloy is recommended.
6. No more than one wave soldering pass.

All design applications should refer to Kingbright application notes available at <http://www.KingbrightUSA.com/ApplicationNotes>



Компания «ЭлектроПласт» предлагает заключение долгосрочных отношений при поставках импортных электронных компонентов на взаимовыгодных условиях!

Наши преимущества:

- Оперативные поставки широкого спектра электронных компонентов отечественного и импортного производства напрямую от производителей и с крупнейших мировых складов;
- Поставка более 17-ти миллионов наименований электронных компонентов;
- Поставка сложных, дефицитных, либо снятых с производства позиций;
- Оперативные сроки поставки под заказ (от 5 рабочих дней);
- Экспресс доставка в любую точку России;
- Техническая поддержка проекта, помощь в подборе аналогов, поставка прототипов;
- Система менеджмента качества сертифицирована по Международному стандарту ISO 9001;
- Лицензия ФСБ на осуществление работ с использованием сведений, составляющих государственную тайну;
- Поставка специализированных компонентов (Xilinx, Altera, Analog Devices, Intersil, Interpoint, Microsemi, Aeroflex, Peregrine, Syfer, Eurofarad, Texas Instrument, Miteq, Cobham, E2V, MA-COM, Hittite, Mini-Circuits, General Dynamics и др.);

Помимо этого, одним из направлений компании «ЭлектроПласт» является направление «Источники питания». Мы предлагаем Вам помощь Конструкторского отдела:

- Подбор оптимального решения, техническое обоснование при выборе компонента;
- Подбор аналогов;
- Консультации по применению компонента;
- Поставка образцов и прототипов;
- Техническая поддержка проекта;
- Защита от снятия компонента с производства.



#### Как с нами связаться

**Телефон:** 8 (812) 309 58 32 (многоканальный)

**Факс:** 8 (812) 320-02-42

**Электронная почта:** [org@eplast1.ru](mailto:org@eplast1.ru)

**Адрес:** 198099, г. Санкт-Петербург, ул. Калинина, дом 2, корпус 4, литера А.