

SPVQ3 Water-proof Type

Long travel type applicable to oblique pressing without an actuator



Detector

Slide

Push

Rotary

Power

Dual-in-line Package Type

General-purpose Type

Water-proof Type

Fast Switching Type

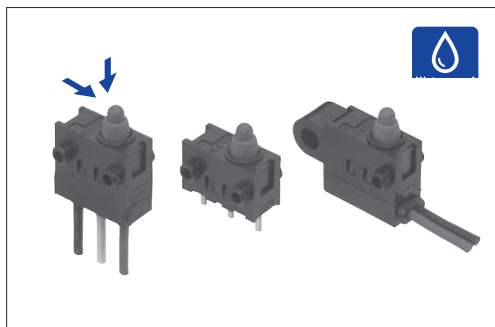

Typical Specifications

Items		Specifications	
		Normal type	Longlife type
Rating (max.)/(min.) (Resistive load)		0.1A 12V DC 50 μ A 5V DC	0.3A 16V DC 1mA 5V DC
Contact resistance (Initial / After operating life)		500m Ω max. / 1 Ω max.	
Operating force		Push type 1 \pm 0.5N Actuator type 3N max.	
Operating life	Without load	300,000cycles	1,200,000cycles
	With load	300,000cycles (0.1A 12V DC)	1,200,000cycles (0.1A 16V DC) 300,000cycles (0.3A 16V DC)
Poles		1	
Changeover timing		Non shorting	

Product Line

Operating life	Positions	Operating part shape	Terminal type	Product No. (Main body form)					Minimum order unit (pcs)		Packing specification type	Drawing No.		
				Normal	Boss - right side	Boss - left side	Boss - both sides	With a screw hole	Japan	Export				
300,000 cycles	2	Push	For PC board	SPVQ380400	SPVQ380300	SPVQ380201	SPVQ380100	—	1,300	5,200	A	1		
			For Lead	—	SPVQ380700	SPVQ380600	SPVQ380500	—				2		
			Right angle	—	SPVQ380900	—	—	—				3		
			Left angle	—	—	SPVQ380800	—	—				4		
			With wire (Downwards)	—	—	—	—	SPVQ361000*	400	1,600	B	5		
				—	SPVQ361100*	SPVQ361200*	SPVQ361300*	—				6		
			With wire (Right side)	—	—	—	—	SPVQ361400*				7		
				—	SPVQ361500*	SPVQ361600*	SPVQ361700*	—				8		
	With wire (Left side)	—	SPVQ361800*	SPVQ361900*	SPVQ362000*	—	9							
	2	Actuator A	For PC board	SPVQ370400	SPVQ370300	SPVQ370200	SPVQ370100	—	1,300	5,200	A	1		
			For Lead	—	SPVQ370700	SPVQ370600	SPVQ370500	—				2		
			Right angle	—	SPVQ370900	—	—	—				3		
			Left angle	—	—	SPVQ370800	—	—				4		
			With wire (Downwards)	—	—	—	—	SPVQ350100*	180	720	D	5		
				—	SPVQ350200*	SPVQ350300*	SPVQ350400*	—				6		
			With wire (Right side)	—	SPVQ350600*	SPVQ350700*	SPVQ350800*	—				168	672	C
With wire (Left side)			—	SPVQ350900*	SPVQ351000*	SPVQ351100*	—	9						
2	Actuator B	For PC board	SPVQ371300	SPVQ371200	SPVQ371100	SPVQ371000	—	1,300	5,200	A	1			
		For Lead	—	SPVQ371600	SPVQ371500	SPVQ371400	—				2			
		Right angle	—	SPVQ371800	—	—	—				3			
		Left angle	—	—	SPVQ371700	—	—				4			
		With wire (Downwards)	—	—	—	—	SPVQ351200*	180	720	D	5			
			—	SPVQ351300*	SPVQ351400*	SPVQ351500*	—				6			
		With wire (Right side)	—	SPVQ351700*	SPVQ351800*	SPVQ351900*	—	168	672	C	8			
		With wire (Left side)	—	SPVQ352000*	SPVQ352100*	SPVQ352200*	—				9			

Product Line

Operating life	Positions	Operating part shape	Terminal type	Product No. (Main body form)					Minimum order unit (pcs)		Packing specification type	Drawing No.						
				Normal	Boss - right side	Boss - left side	Boss - both sides	With a screw hole	Japan	Export								
1,200,000 cycles	2	Push	For PC board	SPVQ340400	SPVQ340300	SPVQ340200	SPVQ340100	—	1,300	5,200	A	1						
			For Lead	—	SPVQ340700	SPVQ340600	SPVQ340500	—				2						
			Right angle	—	SPVQ340900	—	—	—				3						
			Left angle	—	—	SPVQ340800	—	—				4						
	1		Actuator A	With wire (Downwards)	—	—	—	—	SPVQ320100*	400	1,600	B	5					
					SPVQ320200*	SPVQ320300*	SPVQ320400*	—	6									
				With wire (Right side)	—	—	—	—	SPVQ320500*				7					
					SPVQ320600*	SPVQ320700*	SPVQ320800*	—	8									
	With wire (Left side)	—		SPVQ320900*	SPVQ321000*	SPVQ321100*	—	9										
		2		Actuator B	For PC board	SPVQ330400	SPVQ330300	SPVQ330200	SPVQ330100				—	1,300	5,200	A	1	
	For Lead				—	SPVQ330700	SPVQ330600	SPVQ330500	—				2					
	Right angle				—	SPVQ330900	—	—	—				3					
	Left angle		—		—	SPVQ330800	—	—	4									
	1	Actuator B	With wire (Downwards)		—	—	—	—	SPVQ310100*	180	720	D	5					
					SPVQ310200*	SPVQ310300*	SPVQ310400*	—	6									
			With wire (Right side)		—	SPVQ310600*	SPVQ310700*	SPVQ310800*	—				168	672	C	8		
					With wire (Left side)	—	SPVQ310900*	SPVQ311000*	SPVQ311100*							—	9	
	2		Actuator B	For PC board	SPVQ331300	SPVQ331200	SPVQ331100	SPVQ331000	—							1,300	5,200	A
For Lead				—	SPVQ331600	SPVQ331500	SPVQ331400	—	2									
Right angle				—	SPVQ331800	—	—	—	3									
Left angle				—	—	SPVQ331700	—	—	4									
1	Actuator B	With wire (Downwards)		—	—	—	—	SPVQ311200*	180	720	D	5						
				SPVQ311300*	SPVQ311400*	SPVQ311500*	—	6										
		With wire (Right side)		—	SPVQ311700*	SPVQ311800*	SPVQ311900*	—				168	672	C	8			
				With wire (Left side)	—	SPVQ312000*	SPVQ312100*	SPVQ312200*							—	9		

Notes

- ※ Products with a wire will be supplied as follows.
 - Unless specified, the length of the lead wire is 250mm. Color is either red, black or yellow. Please consult us for length modification.
 - Unless circuit is specified, wired (downward) types will apply three wires.
 - Please specify circuits (N.O. or N.C.) for wired (side) types. Unless specified, the circuit will apply N.O.
 - Product with wire will be build-to-order.
- This unit cannot be used in water (IP67 rating, except for terminal).

Packing Specifications

Tray

Product No.	Number of packages (pcs.)		Export package measurements (mm)
	1 case /Japan	1 case /export packing	
A	1,300	5,200	540×360×290

Bulk

Product No.	Number of packages (pcs.)		Export package measurements (mm)
	1 case /Japan	1 case /export packing	
B	400	1,600	555×375×223
C	168	672	
D	180	720	540×360×270

Detector
Slide
Push
Rotary
Power
Dual-in-line Package Type
General-purpose Type
Water-proof Type
Fast Switching Type

SPVQ3 Water-proof Type

Dimensions

Unit:mm

No.	Style
1	<p> Terminal No.③-① ON starting point Terminal No.③-② OFF starting point Free position Operating force measurement position Total travel position PC board mounting face Terminal No.① Terminal No.② Terminal No.③ 0.9 2.3 5 5 13 4 4.35 3.3 6.1 (6.4) 8.4 8.7 9.1 5.8 0.5 </p> <p> ※ Refer to page 54 "Actuator Configurations" for operating part shape. ※ Refer to page 54 "Main Body Configurations" for boss positions. </p>
2	<p> Terminal No.③-① ON starting point Terminal No.③-② OFF starting point Free position Operating force measurement position Total travel position Terminal No.① Terminal No.② Terminal No.③ 7.45 4.35 1.5 1.2 2.2 2.3 4.35 4.35 13 4 4.35 6.1 (6.4) 8.4 8.7 9.1 5.8 0.5 </p> <p> ※ Refer to page 54 "Actuator Configurations" for operating part shape. ※ Refer to page 54 "Main Body Configurations" for boss positions. </p>
3	<p> Terminal No.③-① ON starting point Terminal No.③-② OFF starting point Free position Operating force measurement position Total travel position PC board mounting face Terminal No.① Terminal No.② Terminal No.③ 0.9 2.3 5 5 13 4.15 4 6.1 (6.4) 8.4 8.7 9.1 5.8 6 0.5 (2.6) </p> <p> ※ Refer to page 54 "Actuator Configurations" for operating part shape. </p>
4	<p> Terminal No.③-① ON starting point Terminal No.③-② OFF starting point Free position Operating force measurement position Total travel position PC board mounting face Terminal No.① Terminal No.② Terminal No.③ 0.9 2.3 5 5 13 4.15 4 6.1 (6.4) 8.4 8.7 9.1 5.8 6 0.5 (2.6) </p> <p> ※ Refer to page 54 "Actuator Configurations" for operating part shape. </p>

Dimensions

Unit:mm

No.	Style
5	 <p>Terminal No.③-① ON starting point Terminal No.③-② OFF starting point Hole (for M3) Free position Operating force measurement position Total travel position Terminal No.③ Terminal No.② Terminal No.① Wire</p> <p>※ Refer to page 54 "Actuator Configurations" for operating part shape.</p>
6	 <p>Terminal No.③-① ON starting point Terminal No.③-② OFF starting point Free position Operating force measurement position Total travel position Terminal No.③ Terminal No.② Terminal No.① Wire</p> <p>※ Refer to page 54 "Actuator Configurations" for operating part shape. ※ Refer to page 54 "Main Body Configurations" for boss positions.</p>
7	 <p>Terminal No.③ Terminal No.① or ② Terminal No.③-① ON starting point Free position Operating force measurement position Total travel position Hole (for M3) Wire</p> <p>※ Refer to page 54 "Actuator Configurations" for operating part shape.</p>
8	 <p>Terminal No.③ Terminal No.① or ② Terminal No.③-① ON starting point Free position Operating force measurement position Total travel position Wire</p> <p>※ Refer to page 54 "Actuator Configurations" for operating part shape. ※ Refer to page 54 "Main Body Configurations" for boss positions.</p>

Detector

Slide

Push

Rotary

Power

Dual-in-line
Package Type

General-
purpose Type

Water-proof
Type

Fast Switching
Type

SPVQ3 Water-proof Type

Detector

Slide

Push

Rotary

Power

Dual-in-line Package Type

General-purpose Type

Water-proof Type

Fast Switching Type

Dimensions

Unit:mm



Actuator Configurations

Unit:mm



Main Body Configurations

Unit:mm









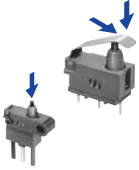
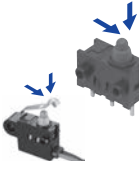

Circuit Diagram

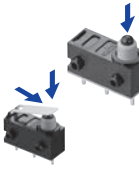
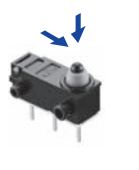

Detector Switches

List of Varieties

Series		Water-proof Type				
		SPVQ1	SPVQ3	SPVQ4H	SPVQ6	SPVQ7
Photo						
Operation type		One-way Two-way	Two-way		One-way Two-way	Two-way
Dimensions (mm)	W	13.3	13	19	13.3	14.7
	D	5.8		6	5.3	5.4
	H	8	8.35	11.9	7	6.7
Operating temperature range		-40°C to +85°C				
Automotive use		●	●	●	●	●
Life cycle (availability)						
Poles / Positions		1/2	1/1 1/2		1/2	1/1 1/2
Rating (max.) (Resistive load)		0.1A 12V DC	0.1A 12V DC or 0.3A 16V DC	0.1A 12V DC		
Rating (min.) (Resistive load)		50μA 3V DC	50μA 5V DC or 1mA 5V DC	1mA 5V DC	50μA 5V DC	
Durability	Operating life without load	300,000cycles 1Ω max.	300,000cycles or 1,200,000cycles 1Ω max.	300,000cycles 1Ω max.		
	Operating life with load Rating (max.) (Resistive load)	300,000cycles 1Ω max.	300,000cycles or 1,200,000cycles 1Ω max.	300,000cycles 1Ω max.		
Electrical performance	Initial contact resistance	500mΩ max.				
	Insulation resistance	100MΩ min. 500V DC				
	Voltage proof	500V AC for 1minute				
Mechanical performance	Terminal strength	3N for 1minute (with terminal) Wire strength 30N for 1minute (with wire)		Wire strength 30N for 1 minute	3N for 1minute	
	Actuator strength	20N				
Environmental performance	Cold	-40°C 500h				
	Dry heat	85°C 500h				
	Damp heat	60°C, 90 to 95% RH 500h				
Operation force		2N max. 5.9N max.	1±0.5N 3N max.	3N max.	1±0.5N 3N max.	1±0.5N
Page		46	50	55	56	59

Detector Switches Soldering Conditions	73
Detector Switches Cautions	74

Note

- Indicates applicability to all products in the series.

Detector Switches Soldering Conditions

Example of Reflow Soldering Condition

1. Heating method: Double heating method with infrared heater.
2. Temperature measurement: Thermocouple $\phi 0.1$ to 0.2 CA (K) or CC (T) at soldering portion (copper foil surface). A heat resisting tape should be used for fixed measurement.
3. Temperature profile



Series (Reflow type)	A (°C) 3s max.	B (°C)	C (s)	D (°C)	E (°C)	F (s)
SPPB	250	230	40	180	150	120
SPPW8			35			
SPVE	260		40			
SPVL						
SPVM						
SPVN						
SPVR						
SPVS						
SPVT						
SSCM						
SSCQ						
SPVQC, SPVQE	250					

Notes

1. The condition mentioned above is the temperature on the mounting surface of a PC board. There are cases where the PC board's temperature greatly differs from that of the switch, surface depending on the PC board's material, size, thickness, etc. The above-stated conditions shall also apply to switch surface temperatures.
2. Soldering conditions differ depending on reflow soldering machines. Prior verification of soldering condition is highly recommended.

Reference for Hand Soldering

Series	Soldering temperature	Soldering time
SPVS, SPVN, SPVT, SPVM, SPVR, SPVE, SPPW8, SSCQ, SSCM, SPVL, SSCT, SPVQC, SPVQE	350±5°C	3s max.
SPVQ1, SPVQ3, SPVQ6, SPVQ7, SPVQ8, SPVQ9, SSCN, SPVQA	300±10°C	3 + 1 / 0s
SPPB (Reflow)	300±5°C	5s max.
SSCF, SPPB (For Lead, Dip)	350±10°C	3 + 1 / 0s

Reference for Dip Soldering

(For PC board terminal types)

Series	Items		Dip soldering	
	Preheating temperature	Preheating time	Soldering temperature	Duration of immersion
SSCT, SPVQ1, SPVQ3, SPVQ6, SPVQ7, SPVQ8, SPVQ9, SPVQA	100±10°C	60s max.	260±5°C	5±1s
SPPW8, SPPB	100 °C max.	60s max.	255±5°C	5±1s
SSCF	—		260±5°C	5±1s



Компания «ЭлектроПласт» предлагает заключение долгосрочных отношений при поставках импортных электронных компонентов на взаимовыгодных условиях!

Наши преимущества:

- Оперативные поставки широкого спектра электронных компонентов отечественного и импортного производства напрямую от производителей и с крупнейших мировых складов;
- Поставка более 17-ти миллионов наименований электронных компонентов;
- Поставка сложных, дефицитных, либо снятых с производства позиций;
- Оперативные сроки поставки под заказ (от 5 рабочих дней);
- Экспресс доставка в любую точку России;
- Техническая поддержка проекта, помощь в подборе аналогов, поставка прототипов;
- Система менеджмента качества сертифицирована по Международному стандарту ISO 9001;
- Лицензия ФСБ на осуществление работ с использованием сведений, составляющих государственную тайну;
- Поставка специализированных компонентов (Xilinx, Altera, Analog Devices, Intersil, Interpoint, Microsemi, Aeroflex, Peregrine, Syfer, Eurofarad, Texas Instrument, Miteq, Cobham, E2V, MA-COM, Hittite, Mini-Circuits, General Dynamics и др.);

Помимо этого, одним из направлений компании «ЭлектроПласт» является направление «Источники питания». Мы предлагаем Вам помощь Конструкторского отдела:

- Подбор оптимального решения, техническое обоснование при выборе компонента;
- Подбор аналогов;
- Консультации по применению компонента;
- Поставка образцов и прототипов;
- Техническая поддержка проекта;
- Защита от снятия компонента с производства.



Как с нами связаться

Телефон: 8 (812) 309 58 32 (многоканальный)

Факс: 8 (812) 320-02-42

Электронная почта: org@eplast1.ru

Адрес: 198099, г. Санкт-Петербург, ул. Калинина, дом 2, корпус 4, литера А.