

## OVERVIEW:

ASGTX temperature compensated Crystal Oscillators are designed to accommodate a broad breadth of Precision TCXO requirements, without NRE and extended lead-times. This oscillator series is designed and manufactured by Abracon Corporation and is available to order from 1pc to high volume production quantities.

- **1-5 day quick-turn availability of a TCXO/VCTCXO with LVCMOS output, Any frequency between 10MHz & 250MHz**

For example, if a reference oscillator requirement calls out 49.7521MHz;  $\pm 1.00$  ppm TCXO/VCTCXO with LVCMOS output, ASGTX can be configured and shipped within 1-5 days and in most cases, same day if order is received before noon. Customers with low-to-mid annual volume requirements find it difficult to procure custom frequency TCXO/VCTCXO's without costly NRE charges and/or long lead-times ( $\geq 12$  weeks).

- **1-5 day quick turn availability of a TCXO/VCTCXO requiring LVDS or LVPECL Differential output, Any frequency between 10MHz to 1.50GHz**

ASGTX is available with either LVDS or LVPECL output, from **10MHz to 1.50GHz**; at any desired frequency, such as 149.875MHz, 1.00GHz, 1.5GHz, etc. with as tight as  $\pm 1.00$  ppm stability over temperature. No other solution in the marketplace currently offers such capability, especially in a small form-factor of 9.0x7.0x2.24 mm.

ASGTX is suitable for a wide variety of precision timing applications where TCXO/VCTCXO's are typically employed. In addition, for high frequency LO requirements, traditionally customers have relied on SAW based oscillators. Such devices are only available at a few fixed frequencies, such as 915MHz, 1.0GHz, etc. They are typically in 9x14mm or bigger packages and vary as much as  $\pm 100$  ppm over temperature.

Although ASGTX series will be slightly less favorable in phase noise performance compared to SAW based oscillators, it offers the following key advantages:

- o  $\pm 1.00$  ppm stability over  $-30^{\circ}\text{C}$  to  $+70^{\circ}\text{C}$  &  $\pm 2.00$  ppm stability over  $-40^{\circ}\text{C}$  to  $+85^{\circ}\text{C}$
- o **Any carrier frequency** between 10MHz & 1.50GHz
- o LVCMOS Output (10MHz to 250MHz) **or** LVDS / LVPECL Output (10MHz to 1.50GHz)
- o Small form-factor of 9.0x7.0x2.24 mm
- o No NRE or lead-time

## FEATURES:

- 10MHz to 1.50GHz, any Carrier Frequency in differential mode (LVDS or LVPECL)
- 10MHz to 250MHz, any Carrier Frequency in LVCMOS mode
- $-40^{\circ}\text{C}$  to  $+85^{\circ}\text{C}$  operating temperature range
- $\pm 1.0$ ppm stability over  $-30^{\circ}\text{C}$  to  $+70^{\circ}\text{C}$  and  $\pm 2.0$ ppm stability over  $-40^{\circ}\text{C}$  to  $+85^{\circ}\text{C}$
- Minimum guaranteed pull ability of  $\pm 10$ ppm in VCTCXO mode
- Good Phase Noise, excellent Harmonics and Spurious content
- Guaranteed rms jitter of 1.80ps maximum @ 1.50GHz carrier (LVDS mode)
- Immediate availability, 5-day maximum lead-time for small quantities

## APPLICATIONS:

- 40G & 100G Ethernet
- WiMax,
- LTE, BTS
- CATV, LAN, LMDS
- Point-to-Point communication networks

# Configurable High Performance SMD TCXO/VCTCXO

ASGTX

 RoHS/RoHS II Compliant

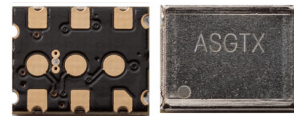

9.0 x 7.0 x 2.24 mm

## KEY ELECTRICAL SPECIFICATIONS:

Parameters		Minimum	Typical	Maximum	Units	Notes
Frequency:	LVC MOS	10		250	MHz	
	LVDS	10		1500		
	LVPECL	10		1500		
Operating Temperature:		-40		+85	°C	
Storage Temperature:		-40		+85	°C	
Frequency Stability:						
Initial Set Tolerance		-1.50	≤ ±1.00	+1.50	ppm	1 hour after reflow
Stability over operating temperature*	-30°C to +70°C	-1.00		+1.00	ppm	Option "1"
	-40°C to +85°C **	-2.00		+2.00		Option "2"
Aging @ 25°C after one year		-1.00		+1.00	ppm	
Supply Voltage (V <sub>dd</sub> ):		3.135	3.300	3.465	V	
Startup Time:				3	ms	
Control Voltage***:		0		V <sub>dd</sub>	V	In VCTCXO Mode
Frequency Pull:		±10			ppm	
Phase jitter RMS [ $t_{jit}( )$ ] **** (12kHz to 20MHz)			<1.00	1.80	ps	Frequency dependent

- Notes**
- \* *Relative to measured frequency post reflow*
  - \*\* *Please contact Abracon for ±1.00 ppm frequency stability over -40°C to +85°C*
  - \*\*\* *Center Control Voltage value is either 1.28V ±0.20V or, 1.55V ±0.20V for the device to be with-in ±1.50 ppm of final frequency, 1-hour post reflow*
  - \*\*\*\* *1.8ps max is guaranteed for LVC MOS and LVDS output modes. For LVPECL mode at carrier frequency greater than 1.289GHz, the maximum RMS jitter is 3.0ps*

## Key Electrical Specifications – LVC MOS

Parameters		Minimum	Typical	Maximum	Units	Notes
Supply Current (I <sub>dd</sub> ):				45	mA	Frequency dependent
Output Load:				15	pF	
Output Logic Level:	V <sub>OH</sub>	0.9*V <sub>dd</sub>			V	
	V <sub>OL</sub>			0.1*V <sub>dd</sub>	V	
Rise Time (Tr):				1000	ps	
Fall Time (Tf):				1000	ps	
Duty Cycle:		45		55	%	@1/2V <sub>dd</sub>

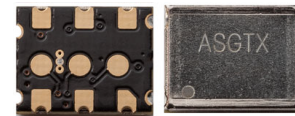

9.0 x 7.0 x 2.24 mm

**ASGTX**

**RoHS/RoHS II Compliant**

## Key Electrical Specifications – LVPECL

Parameters	Minimum	Typical	Maximum	Units	Notes
Supply Current ( $I_{dd}$ )			60	mA	With typical LVPECL output termination
Output Logic Level	$V_{OH}$	$V_{dd}-1.03$		$V_{dd}-0.60$	V
	$V_{OL}$	$V_{dd}-1.85$		$V_{dd}-1.60$	V
Rise Time ( $T_r$ ):			350	ps	
Fall Time ( $T_f$ ):			350	ps	
Differential Duty Cycle:	45		55	%	$DODC_{LVPECL}$

## Key Electrical Specifications – LVDS

Parameters	Minimum	Typical	Maximum	Units	Notes
Supply Current ( $I_{dd}$ )			40	mA	With typical LVDS output termination
Differential Output Voltage ( $V_{OD}$ )	175	350		mV	
$V_{OD}$ Magnitude Change ( $\Delta V_{OD}$ )			50	mV	
Offset Voltage ( $V_{OS}$ )		1.25		V	
$V_{OS}$ Magnitude Change ( $\Delta V_{OS}$ )			50	mV	
Rise Time ( $T_r$ ):			350	ps	
Fall Time ( $T_f$ ):			450	ps	
Differential Duty Cycle:	45		55	%	$ODC_{LVDS}$

## ➤ OPTIONS & PART IDENTIFICATION:

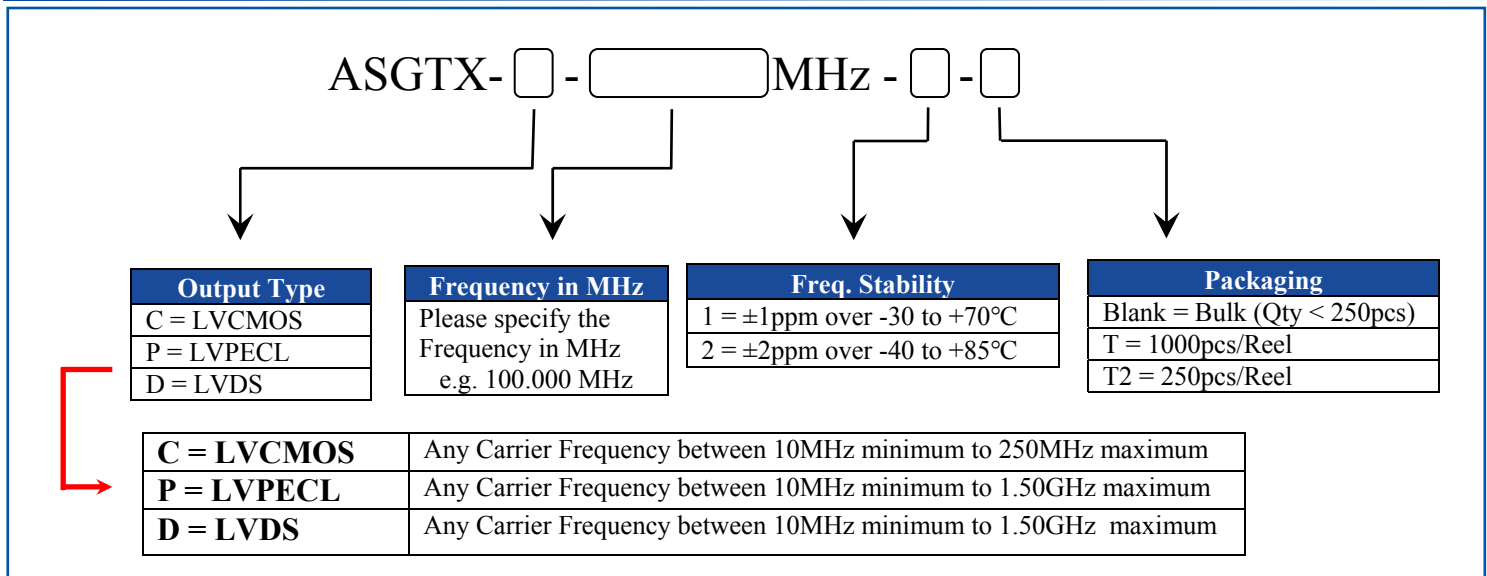

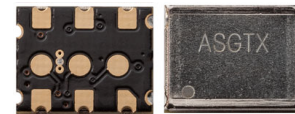

9.0 x 7.0 x 2.24 mm

ASGTX

RoHS/RoHS II Compliant

## TYPICAL PHASE NOISE & JITTER CHARACTERISTICS

With LVCMOS Output; 10MHz Carrier

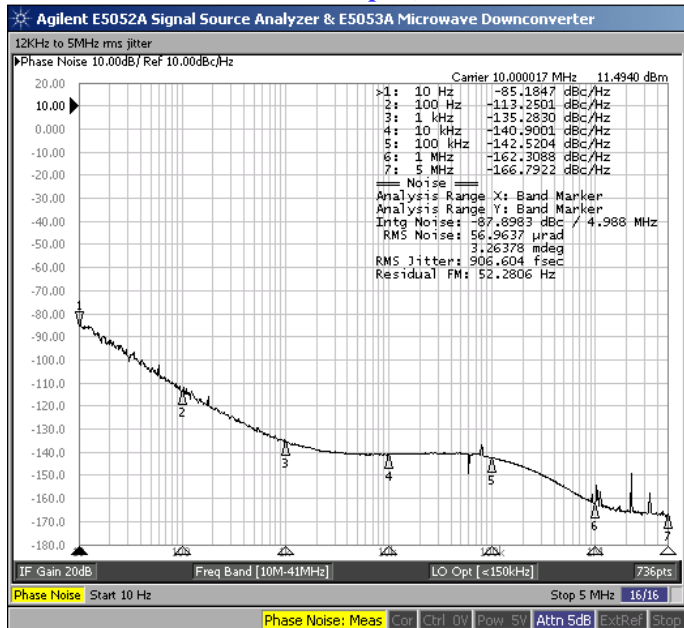

With LVDS Output; 10MHz Carrier

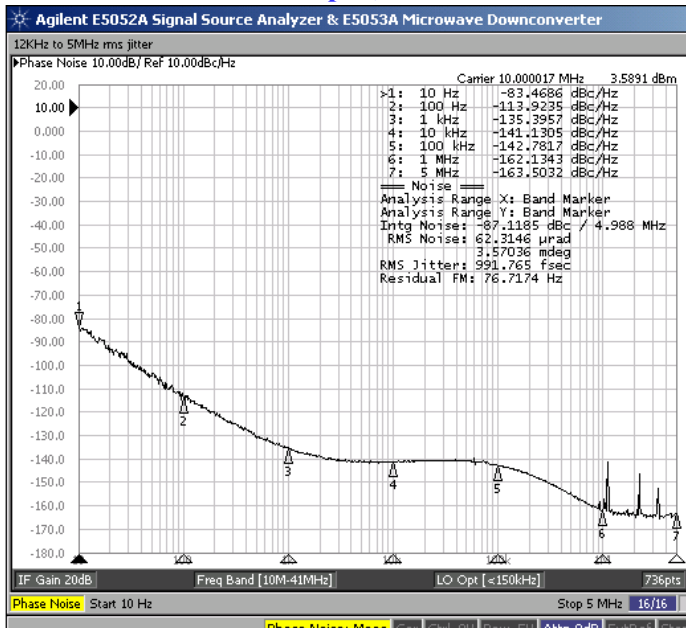

With LVCMOS Output; 25MHz Carrier

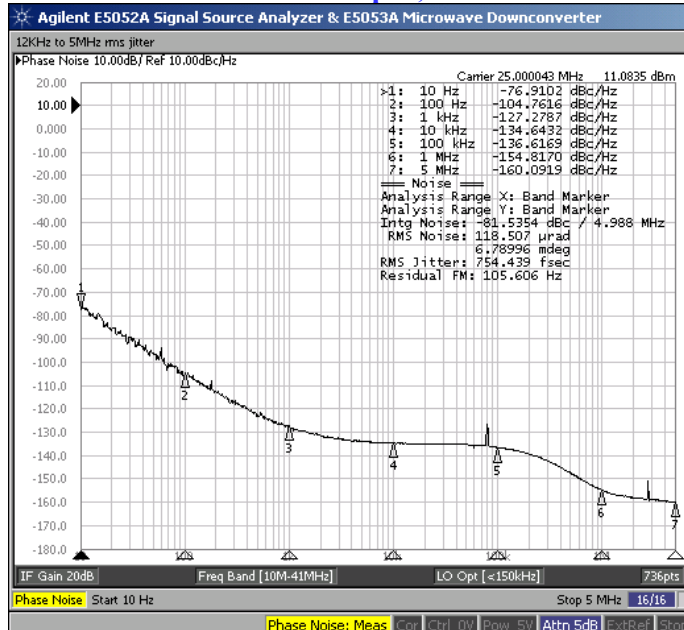

With LVDS Output; 25MHz Carrier

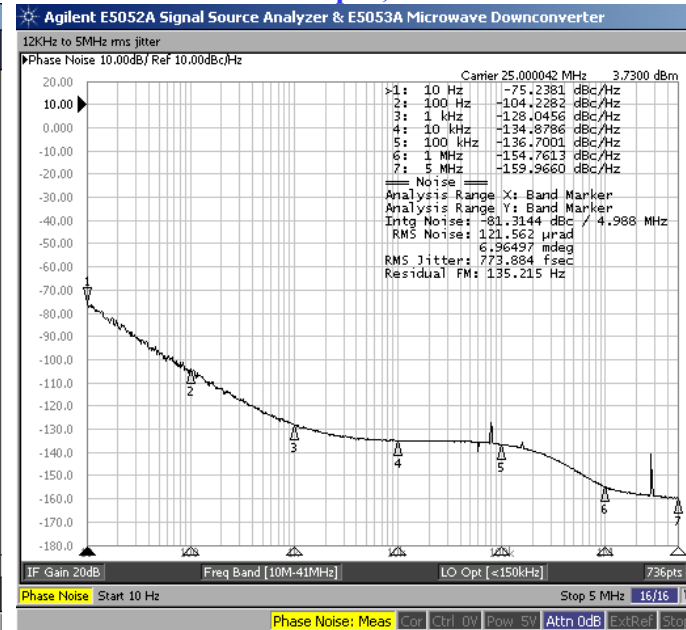

# Configurable High Performance SMD TCXO/VCTCXO

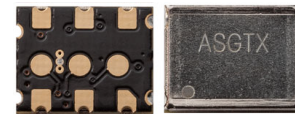

9.0 x 7.0 x 2.24 mm

ASGTX

RoHS/RoHS II Compliant

## TYPICAL PHASE NOISE & JITTER CHARACTERISTICS

### With LVC MOS Output; 50MHz Carrier

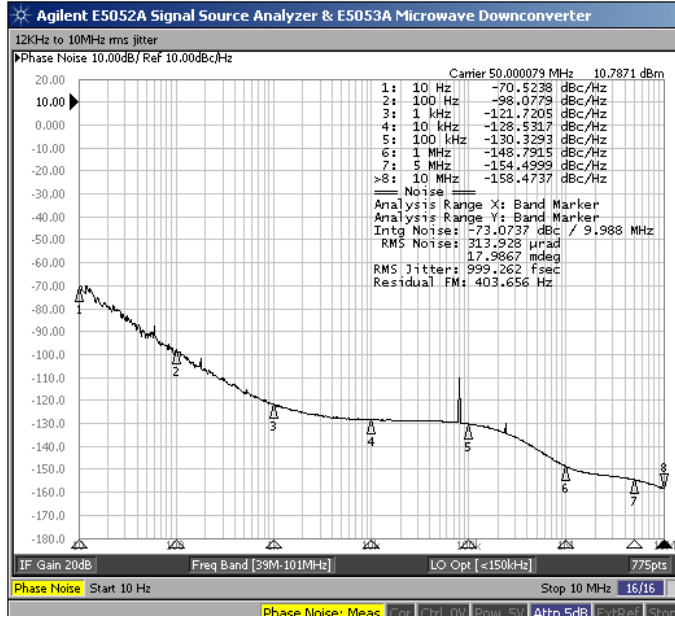

### With LVDS Output; 50MHz Carrier

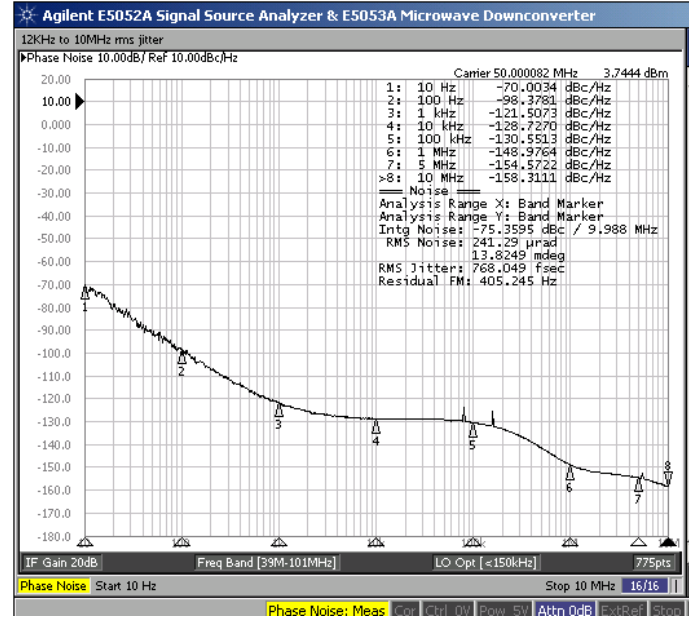

### With LVC MOS Output; 120MHz Carrier

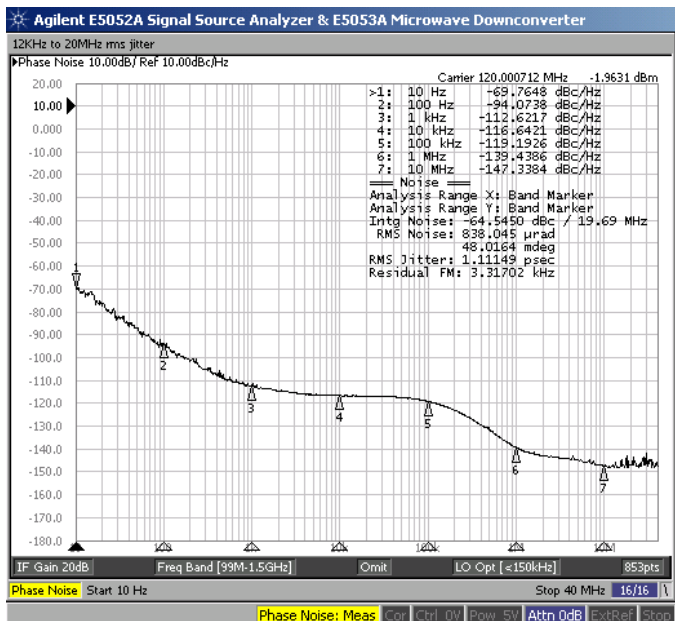

### With LVPECL Output; 500MHz Carrier

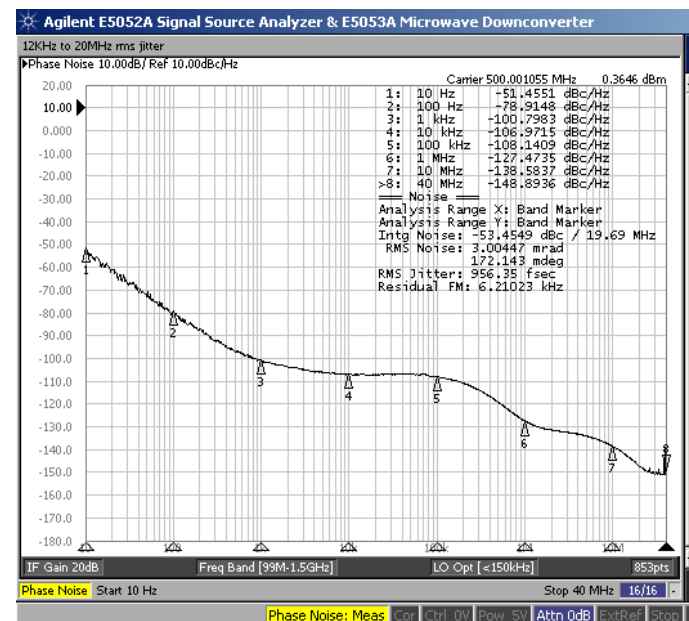

ABRACON IS  
ISO9001:2008  
CERTIFIED



2 Faraday, Suit#B, Irvine, California 92618 Revised: 10.16.14  
tel:949-546-8000 | fax:949-546-8001  
Visit [www.abracon.com](http://www.abracon.com) for Terms & Conditions of Sale

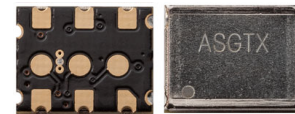

9.0 x 7.0 x 2.24 mm

ASGTX

RoHS/RoHS II Compliant

## TYPICAL PHASE NOISE & JITTER CHARACTERISTICS

With LVDS Output; 1.00GHz Carrier

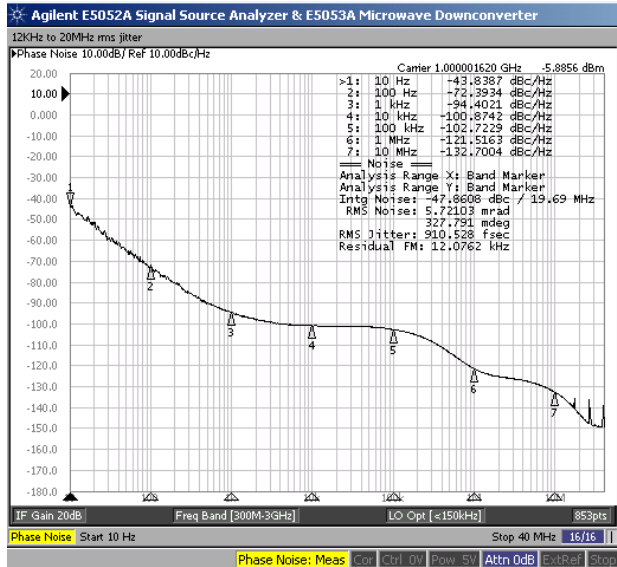

With LVDS Output; 1.2890625GHz Carrier

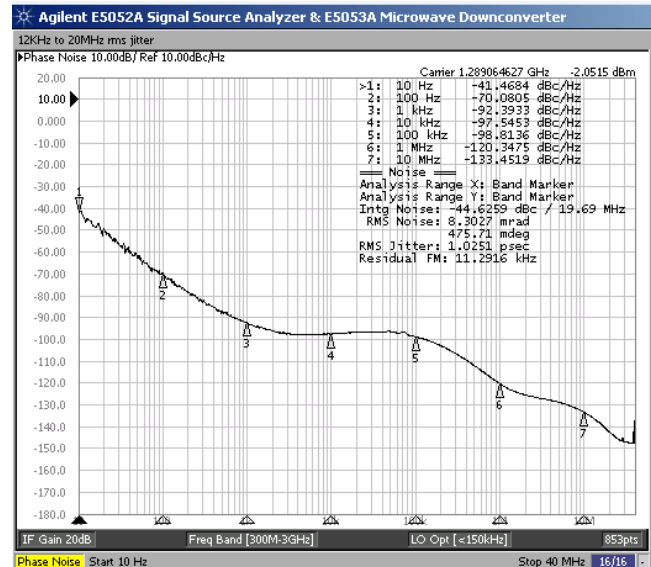

With LVDS Output; 1.50GHz Carrier

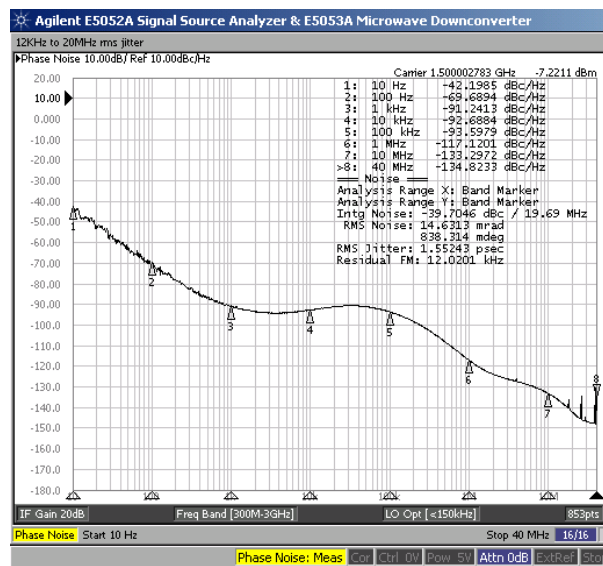

Carrier	RF Output	rms Phase Jitter	Integration Bandwidth
10.00MHz	LVDS	992 fs	12kHz to 5MHz
25.00MHz	LVDS	774 fs	12kHz to 5MHz
50.00MHz	LVDS	768 fs	12kHz to 10MHz
120.00MHz	LVC MOS	1.1 ps	12kHz to 20MHz
500.00MHz	LVPECL	956 fs	12kHz to 20MHz
1.00GHz	LVDS	911 fs	12kHz to 20MHz
1.2890625GHz	LVDS	1.03 ps	12kHz to 20MHz
1.50GHz	LVDS	1.55 ps	12kHz to 20MHz

# Configurable High Performance SMD TCXO/VCTCXO

ASGTX

 RoHS/RoHS II Compliant

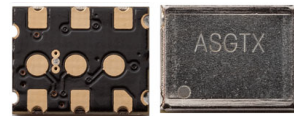

9.0 x 7.0 x 2.24 mm

## FREQUENCY STABILITY VS. TEMPERATURE

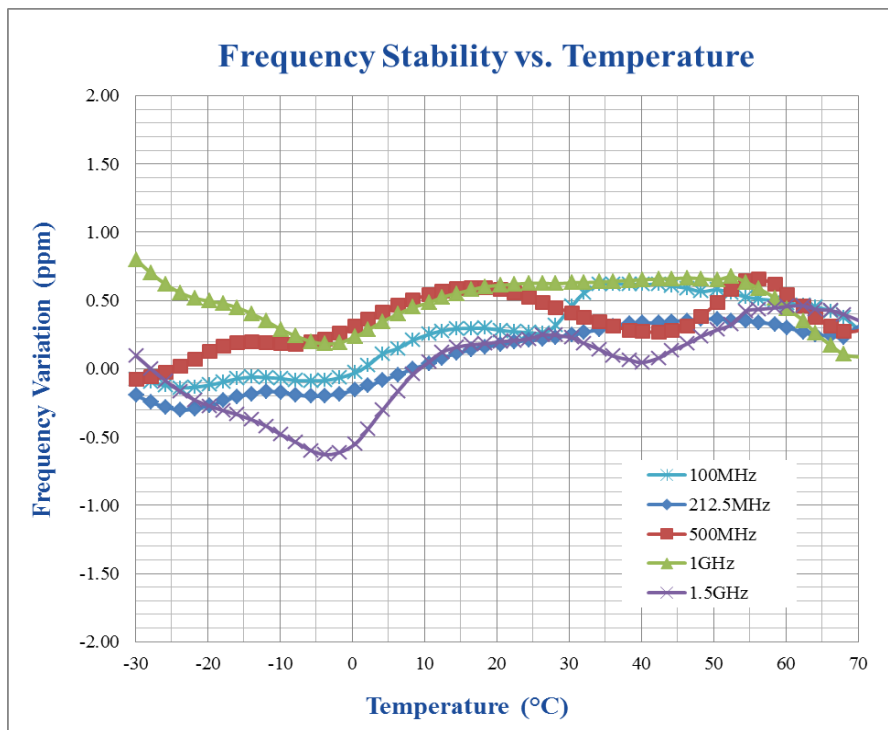

## FREQUENCY PULL VS. CONTROL VOLTAGE (VCTCXO MODE)

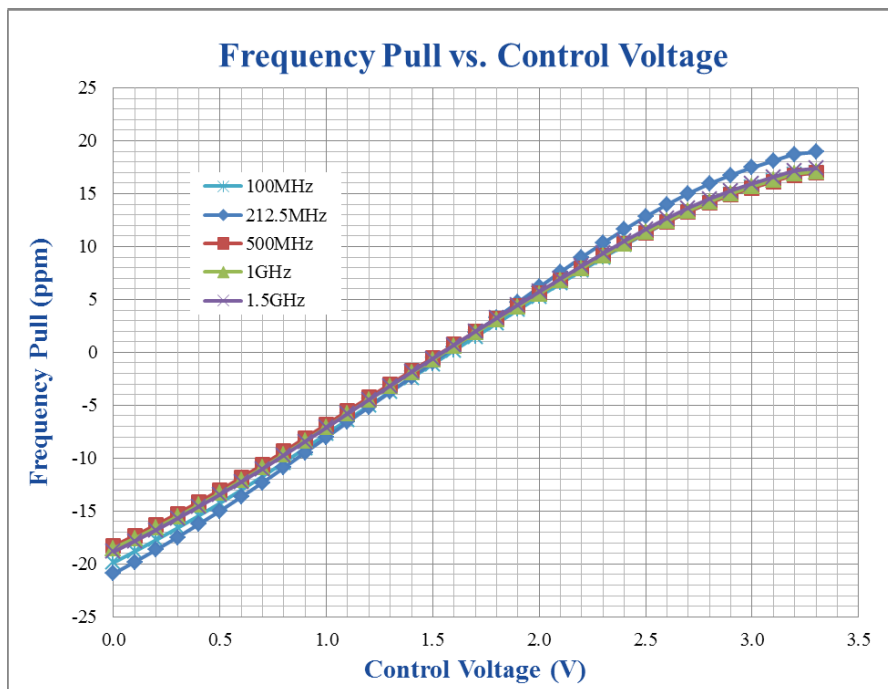

# Configurable High Performance SMD TCXO/VCTCXO

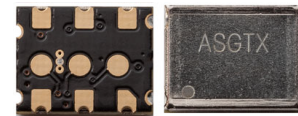

9.0 x 7.0 x 2.24 mm

ASGTX

RoHS/RoHS II Compliant

## OUTLINE DIMENSION:

### LVC MOS output

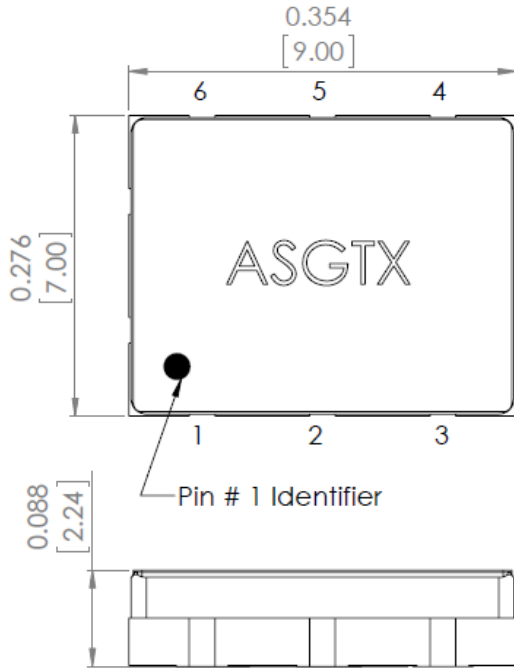

Pin #	Pin Description	
	TCXO	VCTCXO
1	N/C <sup>(1)</sup>	
2	By-Pass <sup>(2)</sup>	V <sub>c</sub> <sup>(3)</sup>
3	GND	
4	RF Output	
5	N/C <sup>(1)</sup>	
6	V <sub>dd</sub>	

N/C <sup>(1)</sup> = Please leave these pins electrically floating on the end-PCB

By-Pass <sup>(2)</sup> = In TCXO configuration, it is recommended that a 1,000pF COG by-pass capacitor is connected between Pin#2 and GND

V<sub>c</sub> <sup>(3)</sup> = Please connect external voltage to pull the oscillator frequency

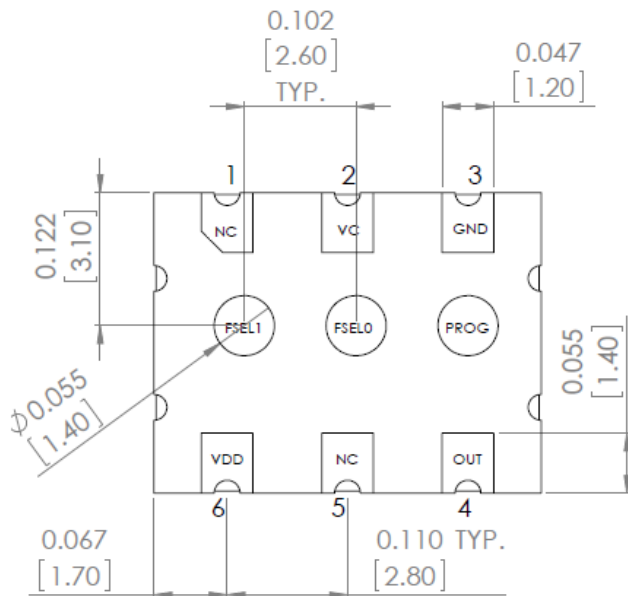

### Recommended Land Pattern

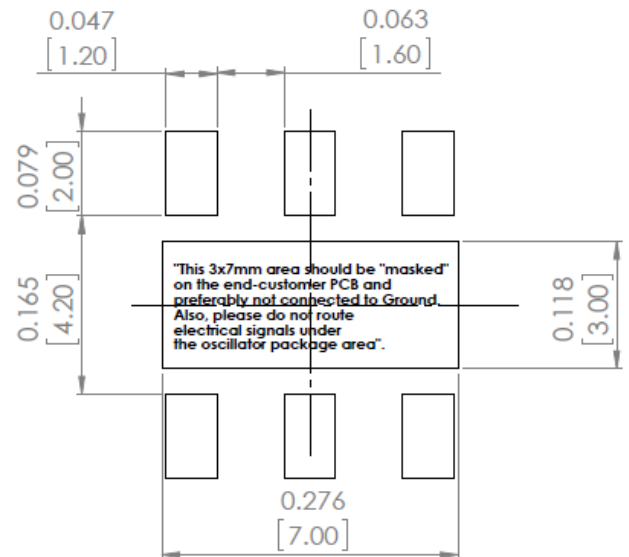

Dimensions: inches [mm]



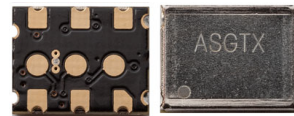

9.0 x 7.0 x 2.24 mm

ASGTX

RoHS/RoHS II Compliant

## LVDS/LVPECL output

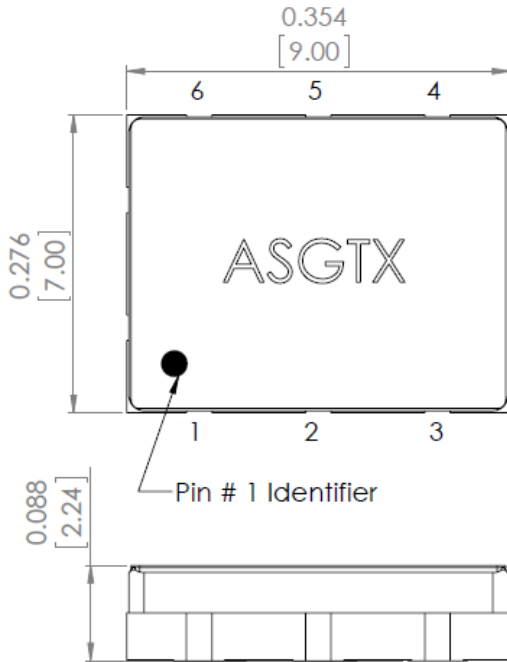

Pin #	Pin Description	
	TCXO	VCTCXO
1	N/C <sup>(1)</sup>	
2	By-Pass <sup>(2)</sup>	Vc <sup>(3)</sup>
3	GND	
4	RF Output	
5	Complimentary RF Output	
6	Vdd	

N/C <sup>(1)</sup> = Please leave this pin electrically floating on the end-PCB

By-Pass <sup>(2)</sup> = In TCXO configuration, it is recommended that a 1,000pF COG by-pass capacitor is connected between Pin#2 and GND

Vc <sup>(3)</sup> = Please connect external voltage to pull the oscillator frequency

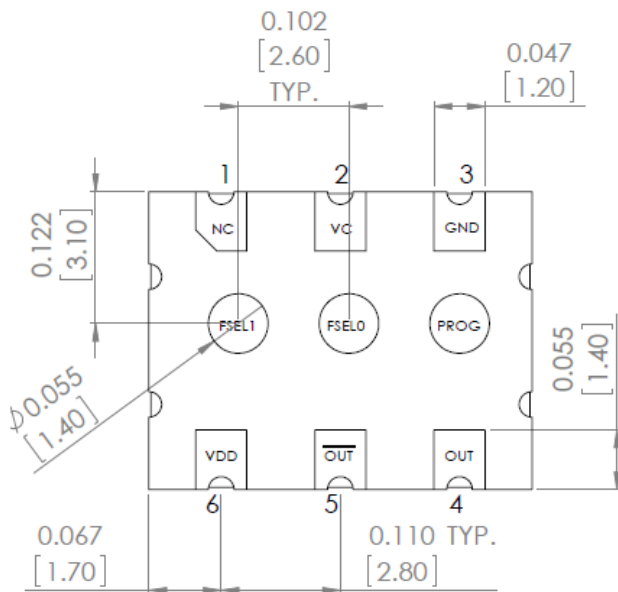

## Recommended Land Pattern

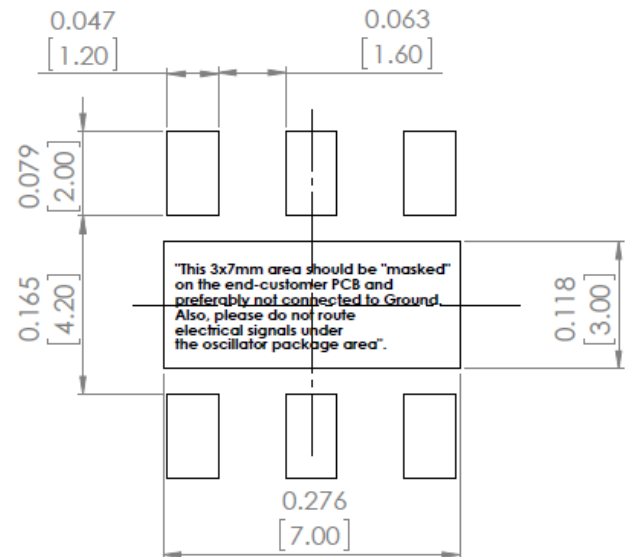

Dimensions: inches [mm]

# Configurable High Performance SMD TCXO/VCTCXO

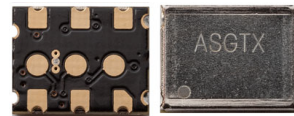

9.0 x 7.0 x 2.24 mm

ASGTX

RoHS/RoHS II Compliant

## REFLOW PROFILE:

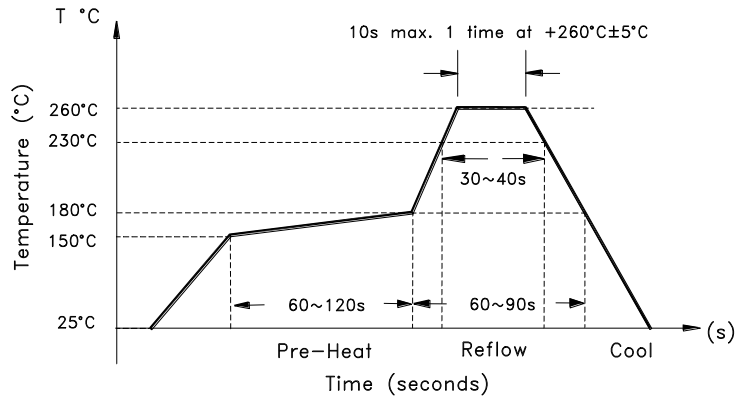

## TAPE & REEL:

Packaging: 1000pcs/reel

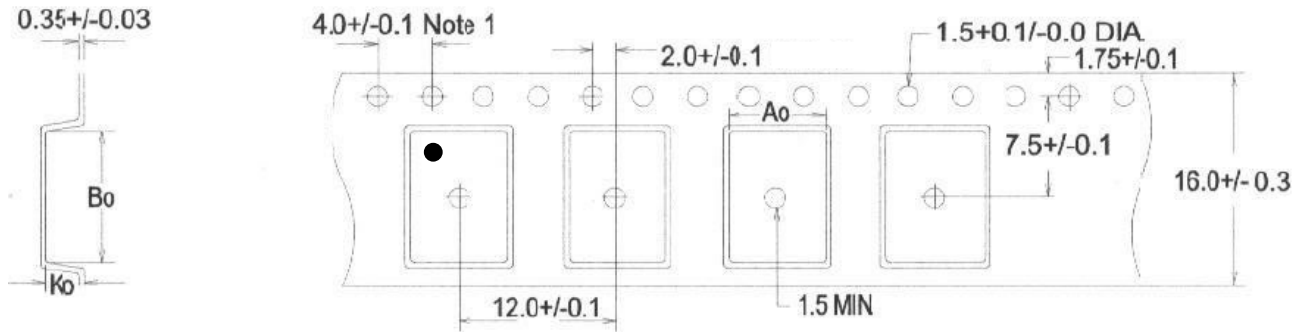

A0	B0	K0
7.10±0.1	9.60±0.1	3.00±0.1

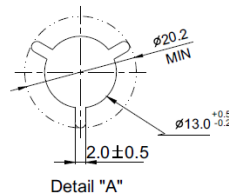
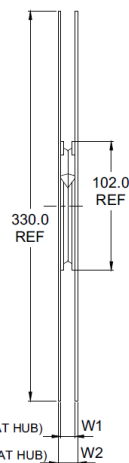
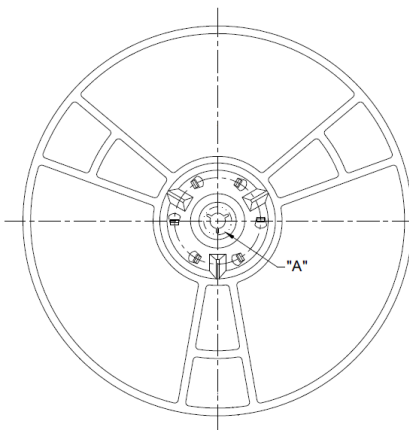

W1	W2
16.8+0.6/-0.4	22.2 max.

Dimensions: mm

**ATTENTION:** Abracon Corporation's products are COTS – Commercial-Off-The-Shelf products; suitable for Commercial, Industrial and, where designated, Automotive Applications. Abracon's products are not specifically designed for Military, Aviation, Aerospace, Life-dependant Medical applications or any application requiring high reliability where component failure could result in loss of life and/or property. For applications requiring high reliability and/or presenting an extreme operating environment, written consent and authorization from Abracon Corporation is required. Please contact Abracon Corporation for more information.

ABRACON IS  
ISO9001:2008  
CERTIFIED



2 Faraday, Suit#B, Irvine, California 92618 Revised: 10.16.14  
tel:949-546-8000 | fax:949-546-8001  
Visit [www.abracon.com](http://www.abracon.com) for Terms & Conditions of Sale



Компания «ЭлектроПласт» предлагает заключение долгосрочных отношений при поставках импортных электронных компонентов на взаимовыгодных условиях!

Наши преимущества:

- Оперативные поставки широкого спектра электронных компонентов отечественного и импортного производства напрямую от производителей и с крупнейших мировых складов;
- Поставка более 17-ти миллионов наименований электронных компонентов;
- Поставка сложных, дефицитных, либо снятых с производства позиций;
- Оперативные сроки поставки под заказ (от 5 рабочих дней);
- Экспресс доставка в любую точку России;
- Техническая поддержка проекта, помощь в подборе аналогов, поставка прототипов;
- Система менеджмента качества сертифицирована по Международному стандарту ISO 9001;
- Лицензия ФСБ на осуществление работ с использованием сведений, составляющих государственную тайну;
- Поставка специализированных компонентов (Xilinx, Altera, Analog Devices, Intersil, Interpoint, Microsemi, Aeroflex, Peregrine, Syfer, Eurofarad, Texas Instrument, Miteq, Cobham, E2V, MA-COM, Hittite, Mini-Circuits, General Dynamics и др.);

Помимо этого, одним из направлений компании «ЭлектроПласт» является направление «Источники питания». Мы предлагаем Вам помощь Конструкторского отдела:

- Подбор оптимального решения, техническое обоснование при выборе компонента;
- Подбор аналогов;
- Консультации по применению компонента;
- Поставка образцов и прототипов;
- Техническая поддержка проекта;
- Защита от снятия компонента с производства.



#### Как с нами связаться

**Телефон:** 8 (812) 309 58 32 (многоканальный)

**Факс:** 8 (812) 320-02-42

**Электронная почта:** [org@eplast1.ru](mailto:org@eplast1.ru)

**Адрес:** 198099, г. Санкт-Петербург, ул. Калинина, дом 2, корпус 4, литера А.