





SMT POWER INDUCTORS

Flat Coils - PG0083 Series



-  **Height:** 4.2mm Max
-  **Footprint:** 6.8mm x 6.8mm Max
-  **Current Rating:** up to 17.5A
-  **Inductance Range:** 0.32μH to 3.76μH

Electrical Specifications @ 25°C — Operating Temperature -40°C to +95°C¹

Part ⁸ Number	Inductance @I _{rated} ² (μH TYP)	I _{rated} ³ (A)	DCR (mΩ)		Inductance @0A _{dc} (μH ±25%)	Saturation ⁴ Current I _{sAT} (A)	Heating ⁵ Current I _{bc} (A)	Core Loss ⁶ Factor	
			TYP	MAX				(K1)	(K2)
PG0083.401	0.32	17.5	3.0	3.2	0.40	27	17.5	2.25E-10	85.4
PG0083.601	0.48	15	4.5	4.8	0.60	21	15	2.25E-10	99.7
PG0083.102	0.80	12	6.6	7.2	1.0	17	12	2.25E-10	135.9
PG0083.182	1.44	8.0	15.6	16.0	1.8	13	8.0	2.25E-10	179.4
PG0083.232	1.84	7.0	17.5	18.0	2.3	11.5	7.5	2.25E-10	202.2
PG0083.332	2.64	5.5	26.6	27.5	3.3	9.5	5.8	2.25E-10	234.9
PG0083.472	3.76	4.5	36.6	38.0	4.7	8.0	4.5	2.25E-10	281.1

NOTE: To order RoHS compliant part, add the suffix "NL" to the part number (i.e. PG0083.401 becomes PG0083.401NL and PG0083.401T becomes PG0083.401NLT).

Mechanical

Schematic

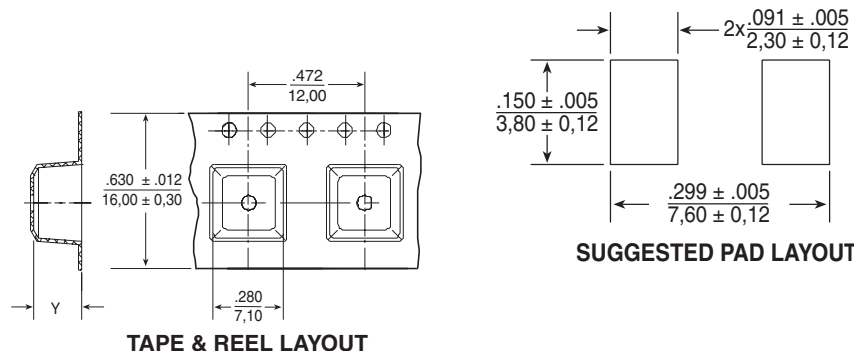
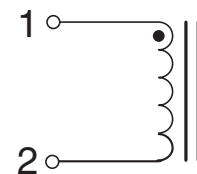
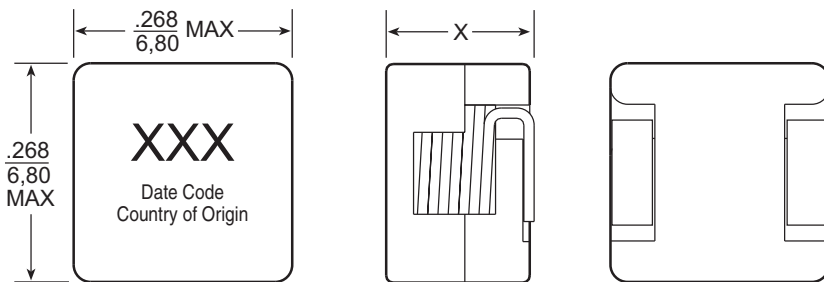

Part No.	Max. Height "X" (in./mm)
PG0083.401	.165/4,20
PG0083.601	.165/4,20
PG0083.102	.165/4,20
PG0083.182	.157/4,00
PG0083.232	.157/4,00
PG0083.332	.157/4,00
PG0083.472	.157/4,00

Dimensions: $\frac{\text{Inches}}{\text{mm}}$
 Unless otherwise specified, all tolerances are $\pm \frac{.010}{0,25}$

Weight.....1.0 grams
 Tape & Reel1000/reel
 T&R Height0.189/4,80
 ("Y" - in./mm)

SMT POWER INDUCTORS

Flat Coils - PG0083 Series



Notes from Tables

1. The temperature of the component (ambient plus temperature rise) must be within the specified operating temperature range.
2. Inductance at I_{rated} is a typical inductance value for the component taken at rated current.
3. The rated current listed is the lower of the saturation current @ 25°C or the heating current.
4. The saturation current, I_{sat} , is the current at which the component inductance drops by 20% (typical) at an ambient temperature of 25°C. This current is determined by placing the component in the specified ambient environment and applying a short duration pulse current (to eliminate self-heating effects) to the component.
5. The heating current, I_{hc} , is the DC current required to raise the component temperature by approximately 40°C. The heating current is determined by mounting the component on a typical PCB and applying current for 30 minutes. The temperature is measured by placing the thermocouple on top of the unit under test. Take note that the component's performance varies depending on the system condition. It is suggested that the component be tested at the system level, to verify the temperature rise of the component during system operation.
6. Core loss approximation is based on published core data:

$$\text{Core Loss} = K1 * (f)^{1.035} * (K2\Delta I)^{2.263}$$

Where: Core Loss = in Watts
 f = switching frequency in kHz
 $K1$ & $K2$ = core loss factors
 ΔI = delta I across the component in Ampere
 $K2\Delta I$ = one half of the peak to peak flux density across the component in Gauss
7. Unless otherwise specified, all testing is made at 100kHz, 0.1Vac.
8. Optional Tape & Reel packaging can be ordered by adding a "T" suffix to the part number (i.e. PG0083.472 becomes PG0083.472T). Pulse complies to industry standard tape and reel specification EIA481.

Inductance vs Current Characteristics

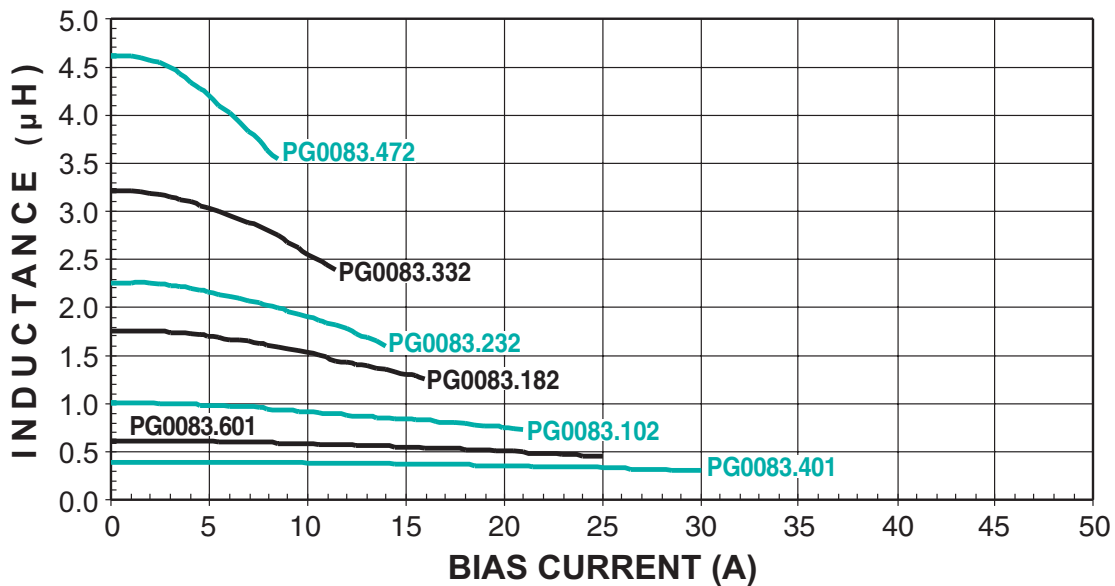



Компания «ЭлектроПласт» предлагает заключение долгосрочных отношений при поставках импортных электронных компонентов на взаимовыгодных условиях!

Наши преимущества:

- Оперативные поставки широкого спектра электронных компонентов отечественного и импортного производства напрямую от производителей и с крупнейших мировых складов;
- Поставка более 17-ти миллионов наименований электронных компонентов;
- Поставка сложных, дефицитных, либо снятых с производства позиций;
- Оперативные сроки поставки под заказ (от 5 рабочих дней);
- Экспресс доставка в любую точку России;
- Техническая поддержка проекта, помощь в подборе аналогов, поставка прототипов;
- Система менеджмента качества сертифицирована по Международному стандарту ISO 9001;
- Лицензия ФСБ на осуществление работ с использованием сведений, составляющих государственную тайну;
- Поставка специализированных компонентов (Xilinx, Altera, Analog Devices, Intersil, Interpoint, Microsemi, Aeroflex, Peregrine, Syfer, Eurofarad, Texas Instrument, Miteq, Cobham, E2V, MA-COM, Hittite, Mini-Circuits, General Dynamics и др.);

Помимо этого, одним из направлений компании «ЭлектроПласт» является направление «Источники питания». Мы предлагаем Вам помощь Конструкторского отдела:

- Подбор оптимального решения, техническое обоснование при выборе компонента;
- Подбор аналогов;
- Консультации по применению компонента;
- Поставка образцов и прототипов;
- Техническая поддержка проекта;
- Защита от снятия компонента с производства.



Как с нами связаться

Телефон: 8 (812) 309 58 32 (многоканальный)

Факс: 8 (812) 320-02-42

Электронная почта: org@eplast1.ru

Адрес: 198099, г. Санкт-Петербург, ул. Калинина, дом 2, корпус 4, литера А.