

PRELIMINARY SPEC



ATTENTION
OBSERVE PRECAUTIONS
FOR HANDLING
ELECTROSTATIC
DISCHARGE
SENSITIVE
DEVICES

Features

- 2.0mmx1.25mm SMT LED, 0.75mm thickness.
- Low power consumption.
- Wide viewing angle.
- Ideal for back light and indicator.
- Various colors and lens types available.
- Package : 2000pcs / reel.
- Moisture sensitivity level : level 4.
- Electrostatic discharge threshold (HBM):1000V.
- Typ. color temperature:6500K
- Color coordinates:x=0.31,y=0.31 acc. to CIE1931(white).
- Optical efficiency:10.94 lm/W(typ.)
- Color reproduction index:80
- RoHS compliant.

Package Dimensions

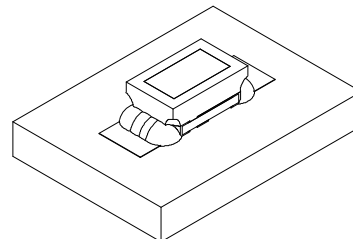
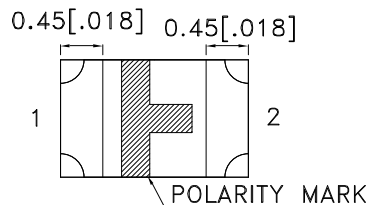
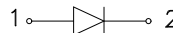
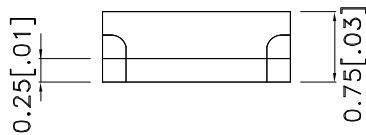
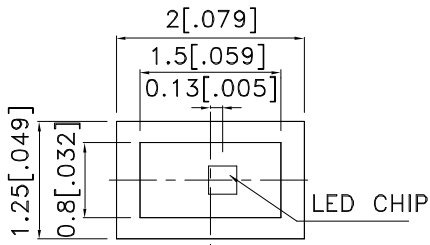

Notes:

1. All dimensions are in millimeters (inches).
2. Tolerance is ± 0.1 (0.004") unless otherwise noted.
3. Specifications are subject to change without notice.
4. The device has a single mounting surface. The device must be mounted according to the specifications.



Part Number: APTK2012RWC/A-F01

White

Description

The source color devices are made with InGaN on SiC Light Emitting Diode.

Static electricity and surge damage the LEDs.

It is recommended to use a wrist band or anti-electrostatic glove when handling the LEDs.

All devices, equipment and machinery must be electrically grounded.

Applications

- traffic signaling.
- backlighting (illuminated advertising , general lighting).
- interior and exterior automotive lighting.
- substitution of micro incandescent lamps.
- Reading camps.
- signal and symbol luminaire for orientation.
- marker lights (e.g. steps, exit ways, etc).
- decorative and entertainment lighting.
- indoor and outdoor commercial and residential architectural lighting.

Selection Guide

Part No.	Dice	Lens Type	Luminous Intensity ^{Note2} Iv(mcd) @ 20 mA		Φ v (mlm) ^{Note3} @ 20 mA	Viewing Angle ^{Note1}
			Min.	Typ.	Typ.	2 θ 1/2
APTK2012RWC/A-F01	WHITE (InGaN)	WATER CLEAR	70	200	700	100°

Absolute Maximum Ratings at TA=25°C

Parameter	Symbol	Value	Unit
Power dissipation	Pt	120	mW
Reverse Voltage	VR	5	V
Junction temperature	TJ	110	°C
Operating Temperature	Top	-40 To +85	°C
Storage Temperature	Tstg	-40 To +100	°C
DC Forward Current	IF	30	mA
Peak Forward Current ^{Note4}	IFM	100	mA
Thermal resistance Junction/ambient ^{Note5} Junction/solder point	Rth JA Rth JS	350 130	°C/W °C/W

Notes:

1. θ 1/2 is the angle from optical centerline where the luminous intensity is 1/2 the optical centerline value.
2. Luminous intensity is measured by a current pulse of 10ms at a tolerance of $\pm 15\%$.
3. The typical data of Luminous Flux can only reflect statistical figures, actual parameters of individual product could differ from the typical data. For the purpose of product enhancement, the typical data is subject to change without prior notice.
4. 1/10 Duty Cycle, 0.1ms Pulse Width.
5. Rth(J-A) Results from mounting on PC board FR4 (pad size $\geq 16 \text{ mm}^2$ per pad),

Electrical / Optical Characteristics at TA=25°C

Parameter	Symbol	Value	Unit
Chromaticity coordinate x acc.to CIE1931 IF=20mA [Typ.]	X ^{Note1}	0.31	-
Chromaticity coordinate y acc.to CIE1931 IF=20mA [Typ.]	Y ^{Note1}	0.31	-
Forward Voltage IF=20mA [Min.]	VF ^{Note2}	2.7	V
Forward Voltage IF=20mA [Typ.]		3.2	
Forward Voltage IF=20mA [Max.]		4.0	
Reverse Current (VR=5V) [Typ.]	IR	0.01	μ A
Reverse Current (VR=5V) [Max.]		10	
Temperature coefficient of x IF=20mA, -10° C \leq T \leq 100° C [Typ.]	TCx	-0.1	10 ⁻³ /° C
Temperature coefficient of y IF=20mA, -10° C \leq T \leq 100° C [Typ.]	TCy	-0.2	10 ⁻³ /° C
Temperature coefficient of VF IF=20mA, -10° C \leq T \leq 100° C [Typ.]	TCV	-2.5	mV/° C

Notes:

1. Chromaticity coordinates are measured by a current pulse of 20ms with a tolerance of ± 0.01 in X and Y color coordinates.
2. Forward voltage is measured with a current pulse of 10ms at a tolerance of $\pm 0.1V$.

Brightness codes

Code.	luminous Intensity ^{Note1} Iv(mcd) @ 20 mA		Φ_v (mlm) ^{Note2} @ 20 mA
	Min.	Max.	Typ.
M	70	130	300
N	110	220	480
P	180	320	710
Q	280	420	960

Notes:

1. Luminous intensity is measured by a current pulse of 10ms at a tolerance of $\pm 15\%$.

2. The typical data of Luminous Flux can only reflect statistical figures, actual parameters of individual product could differ from the typical data. For the purpose of product enhancement, the typical data is subject to change without prior notice.

White

APTK2012RWC/A-F01

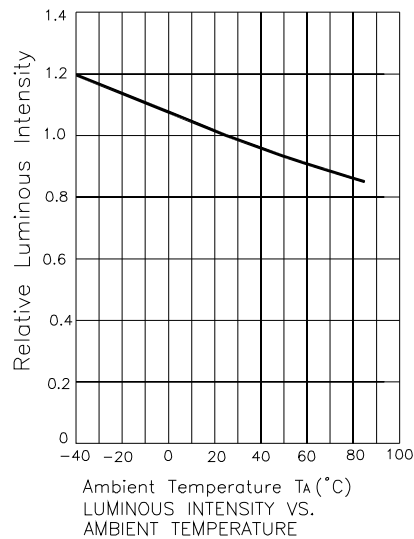
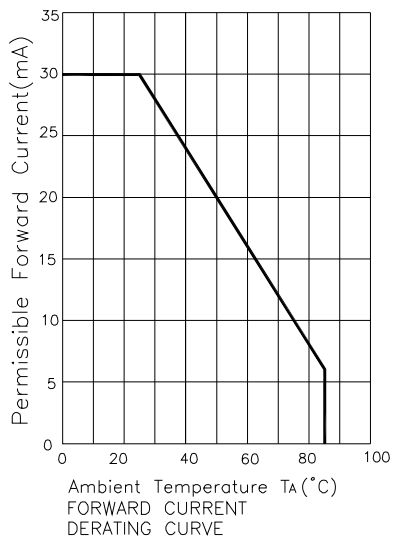
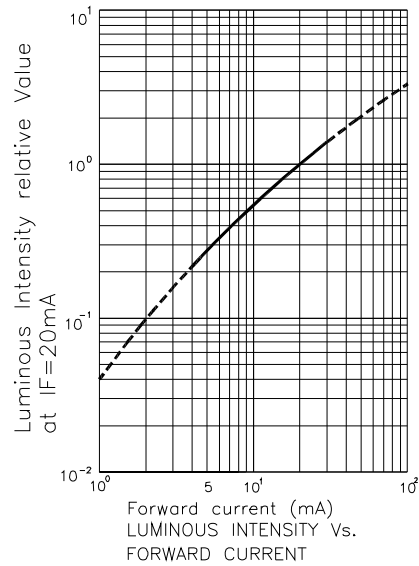
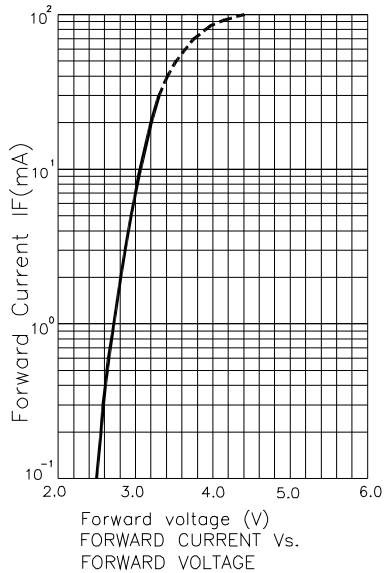

APTK2012RWC/A-F01

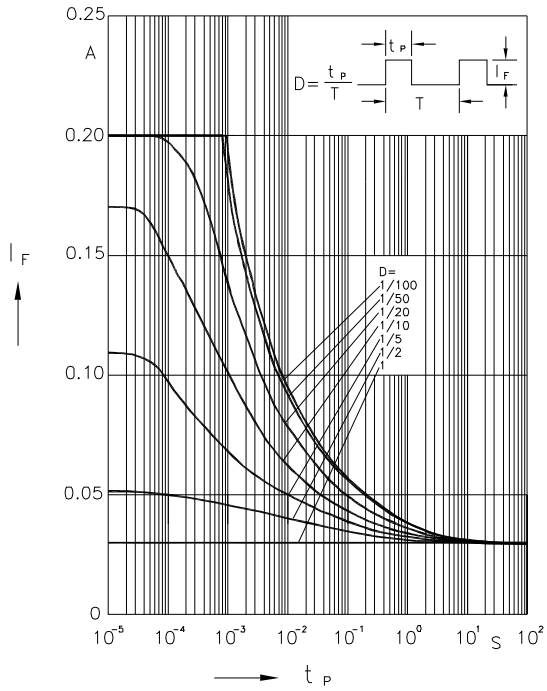

Permissible Pulse Handling Capability
Duty cycle $D = \text{parameter}$, $T_A = 25^\circ\text{C}$

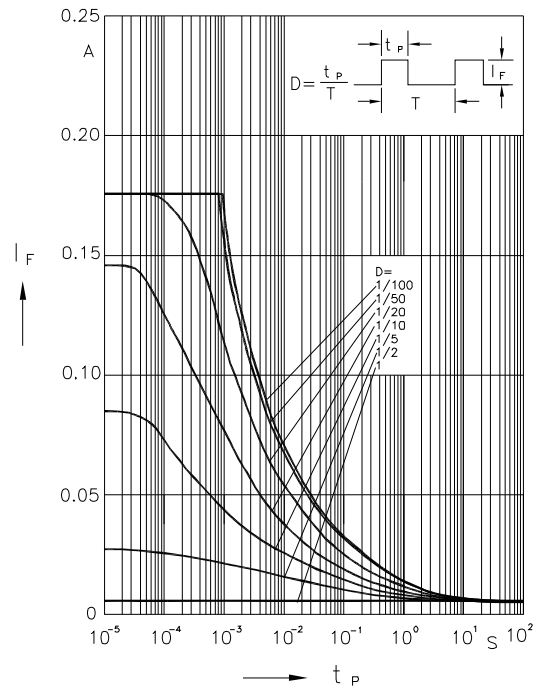

Permissible Pulse Handling Capability
Duty cycle $D = \text{parameter}$, $T_A = 85^\circ\text{C}$

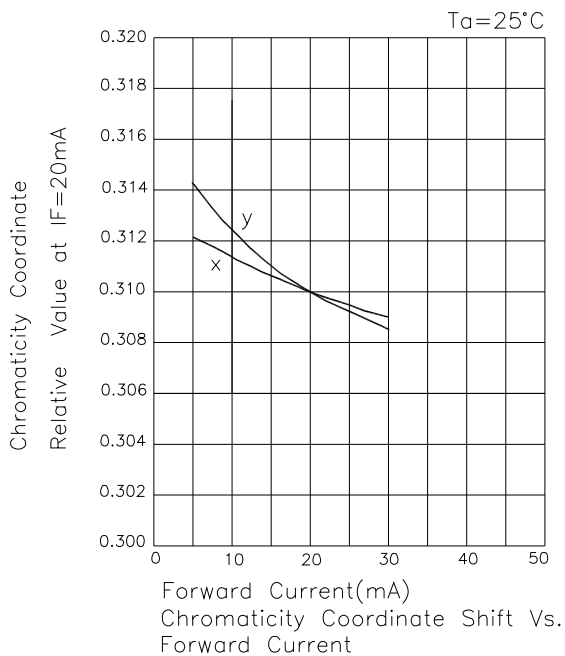

Chromaticity Coordinate
Relative Value at $I_F = 20\text{mA}$
 $T_A = 25^\circ\text{C}$
Chromaticity Coordinate Shift Vs.
Forward Current

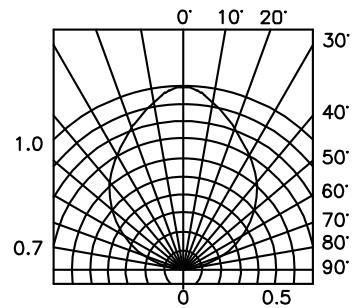
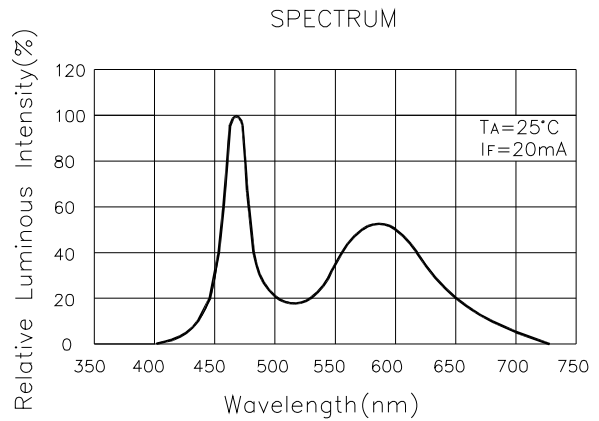

SPATIAL DISTRIBUTION

APTK2012RWC/A-F01

White CIE

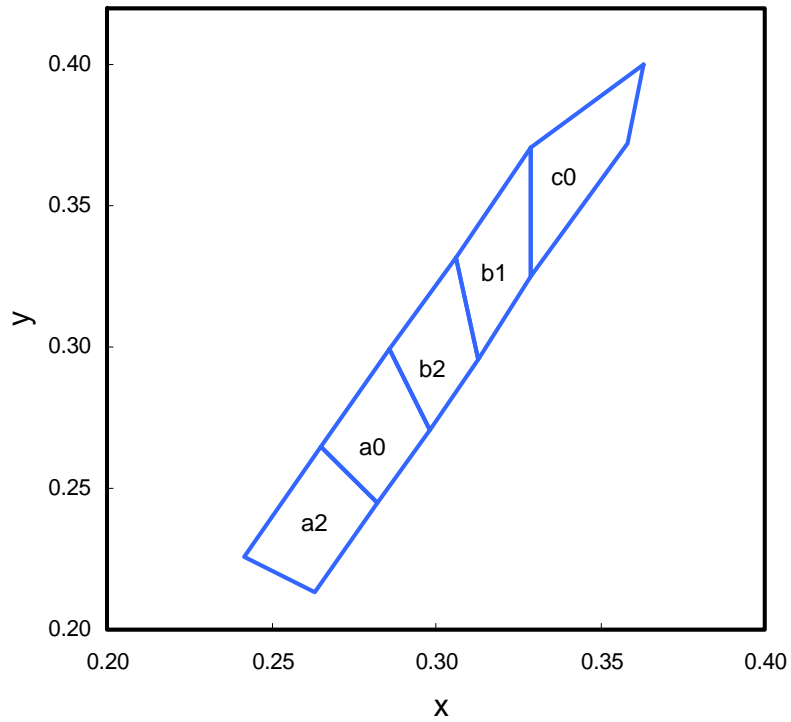

Rank a2				
X	0.263	0.282	0.265	0.242
Y	0.213	0.245	0.265	0.226

Rank a0				
X	0.282	0.298	0.286	0.265
Y	0.245	0.271	0.299	0.265

Rank b2				
X	0.298	0.313	0.306	0.286
Y	0.271	0.296	0.332	0.299

Rank b1				
X	0.313	0.329	0.329	0.306
Y	0.296	0.325	0.371	0.332

Rank c0				
X	0.329	0.358	0.363	0.329
Y	0.325	0.372	0.400	0.371

APTK2012RWC/A-F01

Reflow Soldering Profile For Lead-free SMT Process.

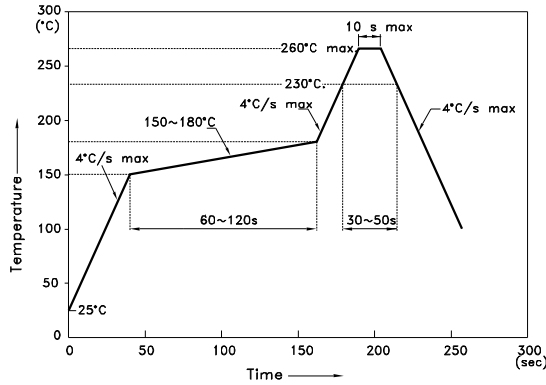

NOTES:

1. We recommend the reflow temperature 245°C(+/-5°C). The maximum soldering temperature should be limited to 260°C.
2. Don't cause stress to the epoxy resin while it is exposed to high temperature.
3. Number of reflow process shall be 2 times or less.

Recommended Soldering Pattern (Units : mm; Tolerance: ± 0.1)

Pad design for improved heat dissipation

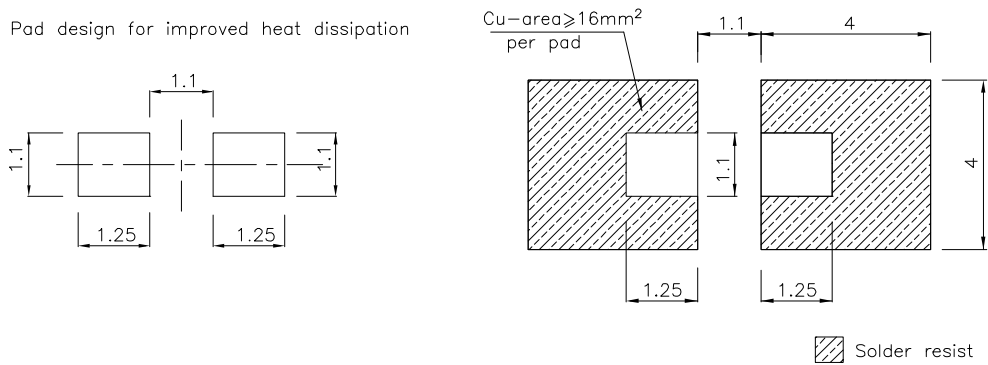

Tape Specifications (Units : mm)

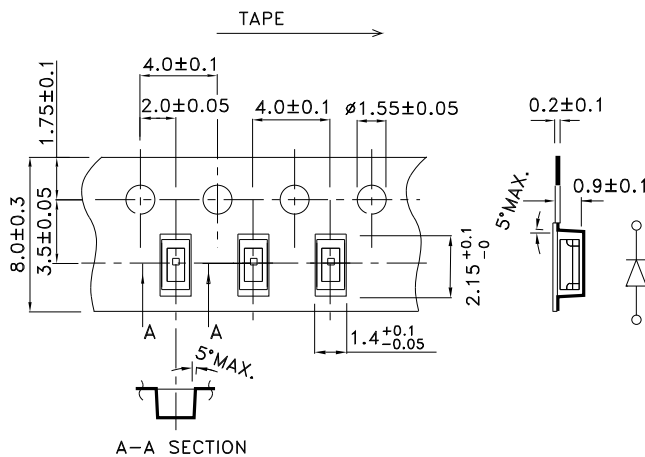

Reel Dimension

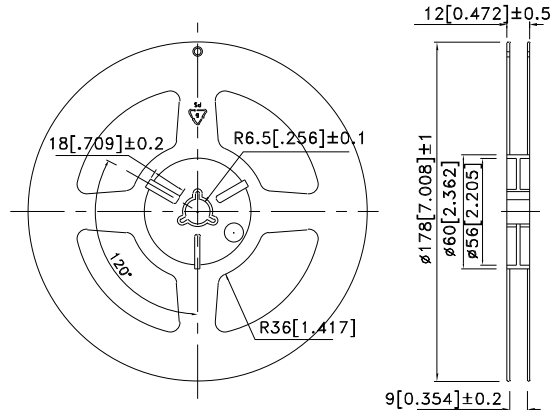

PACKING & LABEL SPECIFICATIONS

APTK2012RWC/A-F01

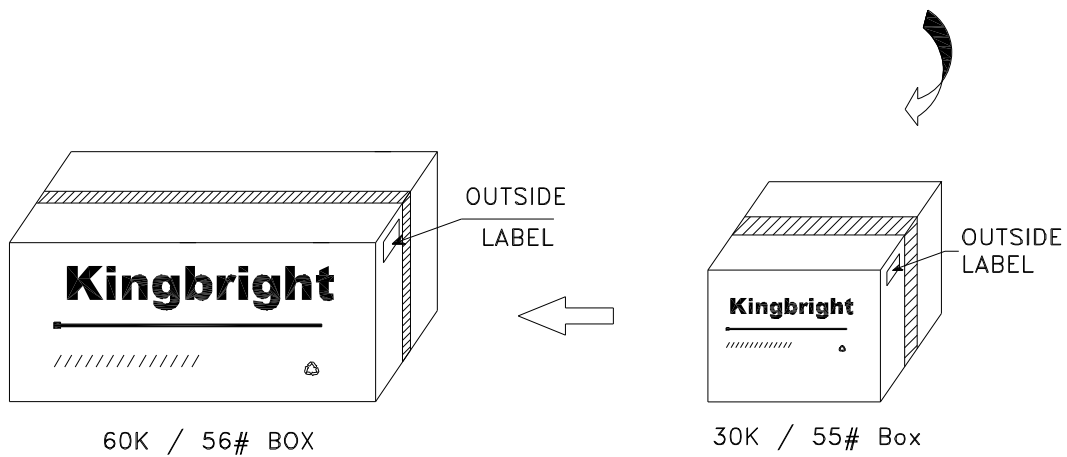
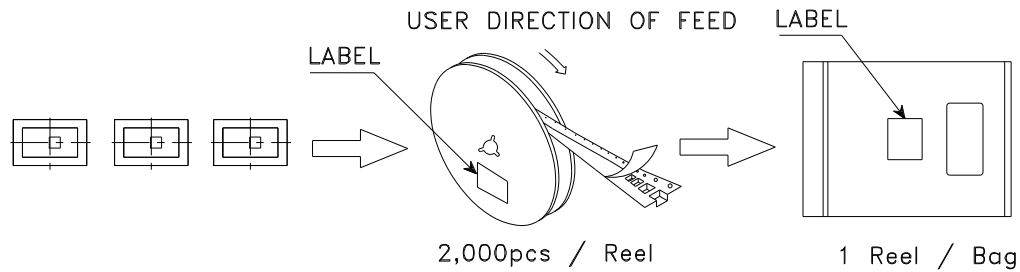

<h2 style="margin: 0;">Kingbright</h2>	
P/NO: APTK2012xxx	
QTY: 2,000 pcs	Q.C. Q C XX XX XXXX PASSED
S/N: XXXX	
CODE: XXX	
LOT NO:	
 <small>XXXXXXXXXXXXXXXXXXXXXXXXXXXX</small>	
RoHS Compliant	



Компания «ЭлектроПласт» предлагает заключение долгосрочных отношений при поставках импортных электронных компонентов на взаимовыгодных условиях!

Наши преимущества:

- Оперативные поставки широкого спектра электронных компонентов отечественного и импортного производства напрямую от производителей и с крупнейших мировых складов;
- Поставка более 17-ти миллионов наименований электронных компонентов;
- Поставка сложных, дефицитных, либо снятых с производства позиций;
- Оперативные сроки поставки под заказ (от 5 рабочих дней);
- Экспресс доставка в любую точку России;
- Техническая поддержка проекта, помощь в подборе аналогов, поставка прототипов;
- Система менеджмента качества сертифицирована по Международному стандарту ISO 9001;
- Лицензия ФСБ на осуществление работ с использованием сведений, составляющих государственную тайну;
- Поставка специализированных компонентов (Xilinx, Altera, Analog Devices, Intersil, Interpoint, Microsemi, Aeroflex, Peregrine, Syfer, Eurofarad, Texas Instrument, Miteq, Cobham, E2V, MA-COM, Hittite, Mini-Circuits, General Dynamics и др.);

Помимо этого, одним из направлений компании «ЭлектроПласт» является направление «Источники питания». Мы предлагаем Вам помощь Конструкторского отдела:

- Подбор оптимального решения, техническое обоснование при выборе компонента;
- Подбор аналогов;
- Консультации по применению компонента;
- Поставка образцов и прототипов;
- Техническая поддержка проекта;
- Защита от снятия компонента с производства.



Как с нами связаться

Телефон: 8 (812) 309 58 32 (многоканальный)

Факс: 8 (812) 320-02-42

Электронная почта: org@eplast1.ru

Адрес: 198099, г. Санкт-Петербург, ул. Калинина, дом 2, корпус 4, литера А.