

MAX17201/MAX17205/MAX17211/ MAX17215 Evaluation Kits

Evaluates: MAX17201/MAX17205/ MAX17211/MAX17215

General Description

The MAX17201/MAX17205/MAX17211/MAX17215 evaluation kits (EV kits) are fully assembled and tested surface-mount PCBs that evaluate the stand-alone ModelGauge™ m5 pack-side fuel-gauge ICs for lithium-ion (Li+) batteries in handheld and portable equipment. The MAX17201 and MAX17211 are for single-cell applications and the MAX17205 and MAX17215 are for multi-cell applications.

The MAX17201/MAX17205/MAX17211/MAX17215 EV kits include the Maxim DS91230+ USB interface, IC evaluation board, and RJ-11 connection cable. Windows® based graphical user interface (GUI) software is available for use with the EV kit and can be downloaded from Maxim's website www.maximintegrated.com/evkitsoftware. Windows 7 or newer Windows operating system is required to use with the EV kit GUI software.

Benefits and Features

- ModelGauge m5 Algorithm
- Nonvolatile Memory Configured for Stand-Alone Operation
- Monitors from 1S to More Than 15S Cell Packs
- Battery Pack Input Voltage Range of +2.1V to +4.9V per Cell
- Thermistor Measurement Network
- Optional On-Board PCB Trace Sense Resistor
- Windows 7 or Newer Compatible Software
- Proven PCB Layout
- Fully Assembled and Tested

MAX17201/MAX17205/MAX17211/ MAX17215 EV Kit Files

FILE	DESCRIPTION
MAX17201_05_11_15K_V2_0_0_0_Install.exe	Installs all EV kit files on your computer

Ordering Information appears at end of data sheet.

Windows is a registered trademarks and registered service marks of Microsoft Corporation.

ModelGauge is a trademark of Maxim Integrated Products, Inc.

Quick Start

Required Equipment

- MAX17201/MAX17205/MAX17211/MAX17215 EV kit
- Lithium battery pack of desired configuration
- Battery charger or power supply
- Load circuit
- DS91230+ USB adapter
- RJ-11 6pos reverse modular cord
- PC with Windows 7 or newer windows operating system and USB port

Procedure

The EV kits are fully assembled and tested. Follow the steps below to install the EV kit software, make required hardware connections, and start operation of the kits. The EV kit software can be run without hardware attached. It automatically locates the hardware when connections are made. Note that after communication is established the IC must still be configured correctly for the fuel gauge to be accurate. See the [Configuration Wizard](#) and [ModelGauge m5 EZ Configuration](#) sections of the GUI software description.

- 1) Visit www.maximintegrated.com/evkitsoftware to download the latest version of the MAX17201_05_11_15K EV kit software. Save the EV kit software to a temporary folder and unpack the ZIP file.
- 2) Install the EV kit software on your computer by running the MAX17201_05_11_15K_Install.exe program inside the temporary folder. The program files are copied and icons are created in the Windows **Start** menu. The software requires the .NET Framework 4.5 or later. If you are connected to the internet, Windows automatically updates .NET framework as needed.
- 3) The EV kit software launches automatically after installation or alternatively it can be launched by clicking on its icon in the Windows **Start** menu.
- 4) Connect the DS91230+ adapter to a USB port on the PC. The DS91230+ is a HID device and is located automatically by Windows without the need to install additional drivers.



MAX17201/MAX17205/MAX17211/ MAX17215 Evaluation Kits

Evaluates: MAX17201/MAX17205/ MAX17211/MAX17215

- For the MAX17205/MAX17215 only: Set the on-board switch SW1 to the proper position based on cell stack size. For 2S to 4S cell stacks set the switch to “2S to 4S” as indicated on the board. For cell stacks of 4S or larger set the switch to “multicell” as indicated on the board. **Warning:** The EV kit board can be damaged when connecting cell stacks higher than 4S if SW1 is in “2S to 4S” position.
- Make connections to the EV kit board based on cell pack configuration as shown in the following figures. The load or charger circuit can be connected at this time as well. Figure 1 shows the connections for a 1S cell pack. The cell connects between the BAT- and BAT+ pads and the charger/load connect between the PACK- and PACK+ pads.

Figure 2 shows the connections for a 2S cell pack with a high-side protector. The lower cell connects between the B1N and B1P/B2P pads and the upper cell connects between the B1P/B2P pads and the BxP pad. The charger/load connects between the PACK- and PACK+ pads. Note B1P and B2P should always be connected together in this configuration.

Figure 3 shows the connections for a 3S cell pack with high-side protector. The lower cell connects between the B1N and B1P pads, the middle cell connects between the B1P and B2P pads, and the upper cell connects between the B2P and BxP pads. The charger/load connects between the PACK- and PACK+ pads.

Figure 4 shows the connections for a 2S to 4S cell pack with low side protector. In this case, the protector circuit prevents connections to individual cells. The entire cell stack connects between the B1N and BxP pads. The charger/load connects between the PACK- and PACK+ pads.

Figure 5 shows the connections for a 4S or larger cell pack. The cell stack connects between the B1N and BxP pads. The positive side of the cell stack also connects to one of the four resistive voltage divider network inputs: B4P for a 4S stack, B6P for a 6S stack, B10P for a 10S stack, B12P for a 12S stack. The charger/load connects between the PACK- and PACK+ pads. If the application cell configuration is not 4S, 6S, 10S, or 12S a custom resistive voltage divider must be created to properly divide the stack voltage for measurement. See the MAX17201/MAX17205/ MAX17211/MAX17215 data sheet for details.

- Connect the RJ-11 cable between the USB adapter and the EV kit board. The GUI software establishes communication automatically.
- If the IC has not been configured, run the Configuration Wizard in the EV kit software to configure operation for the desired application circuit and lithium cell type. Configuration information is permanently saved inside the IC.

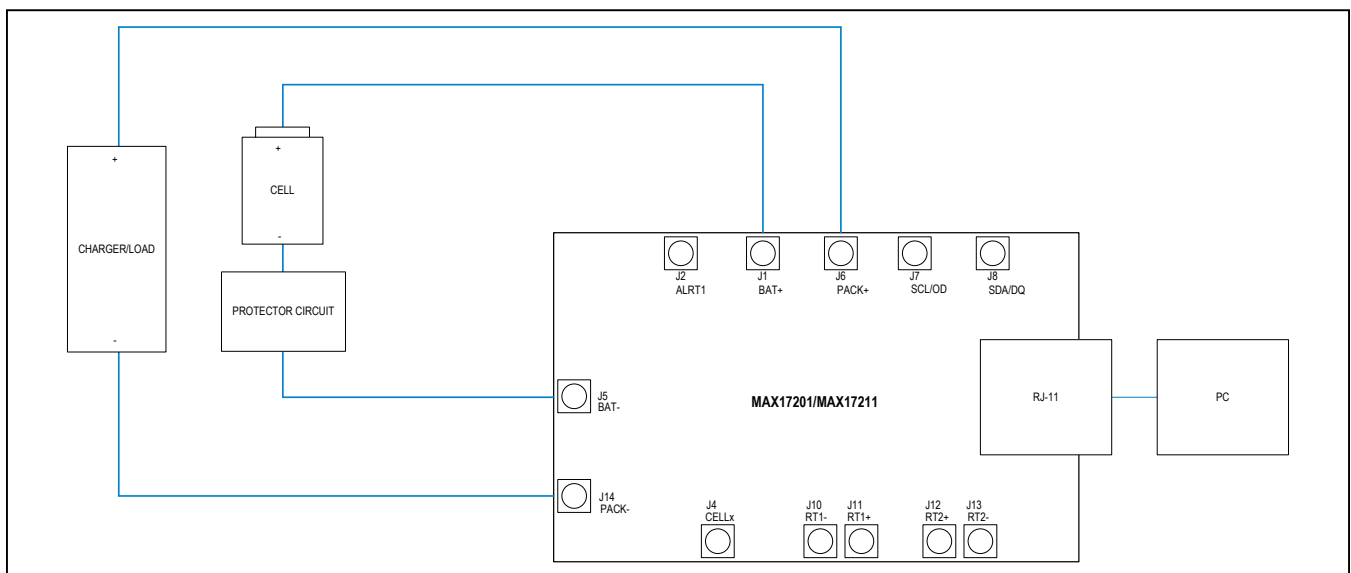

Figure 1. MAX17201/MAX17211 Board Connections

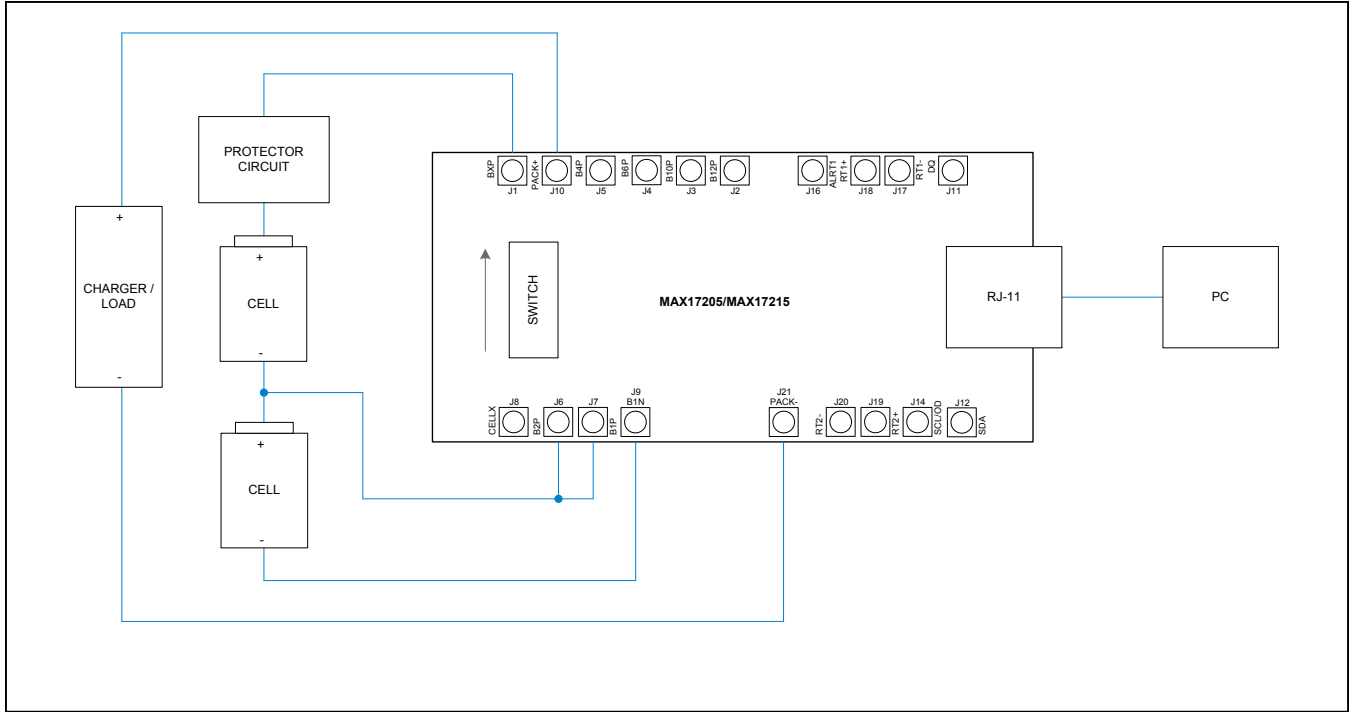

Figure 2. MAX17205/MAX17215 Board Connections for 2S Cell Stacks

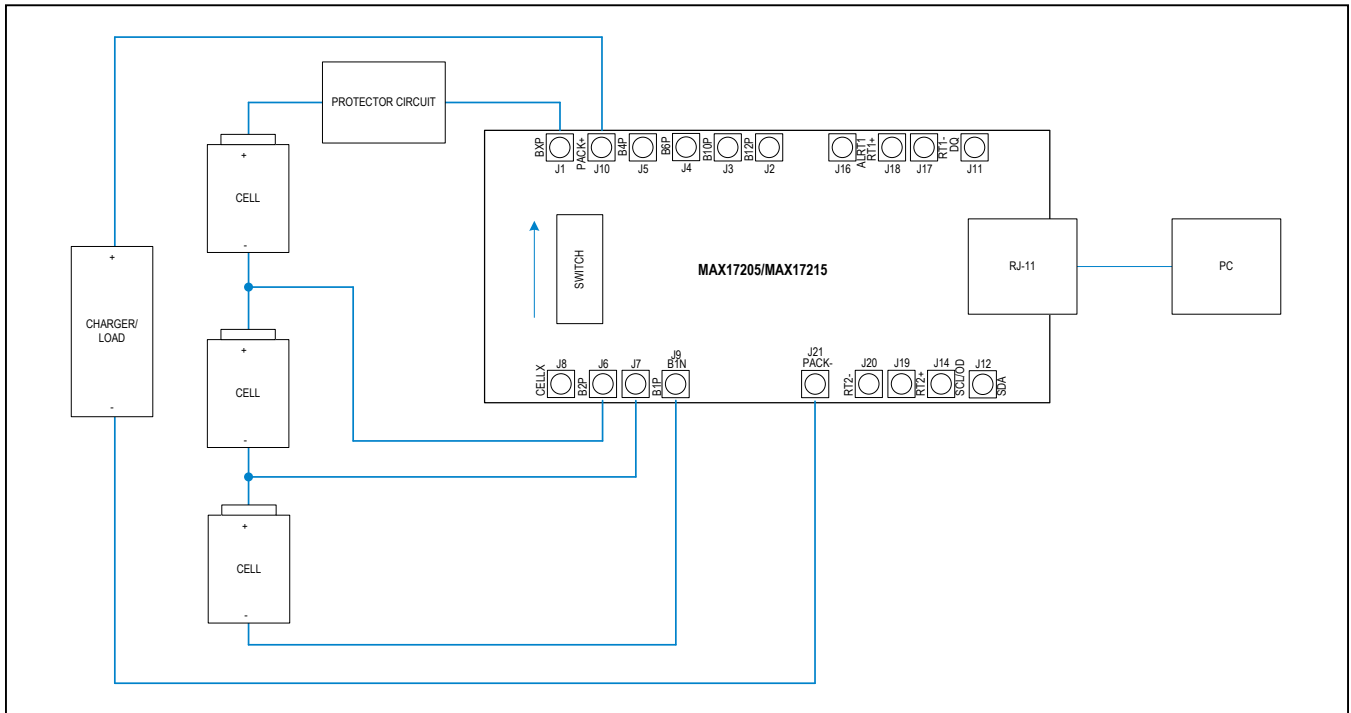

Figure 3. MAX17205/MAX17215 Board Connections for 3S Cell Stacks

MAX17201/MAX17205/MAX17211/
MAX17215 Evaluation Kits

Evaluates: MAX17201/MAX17205/
MAX17211/MAX17215

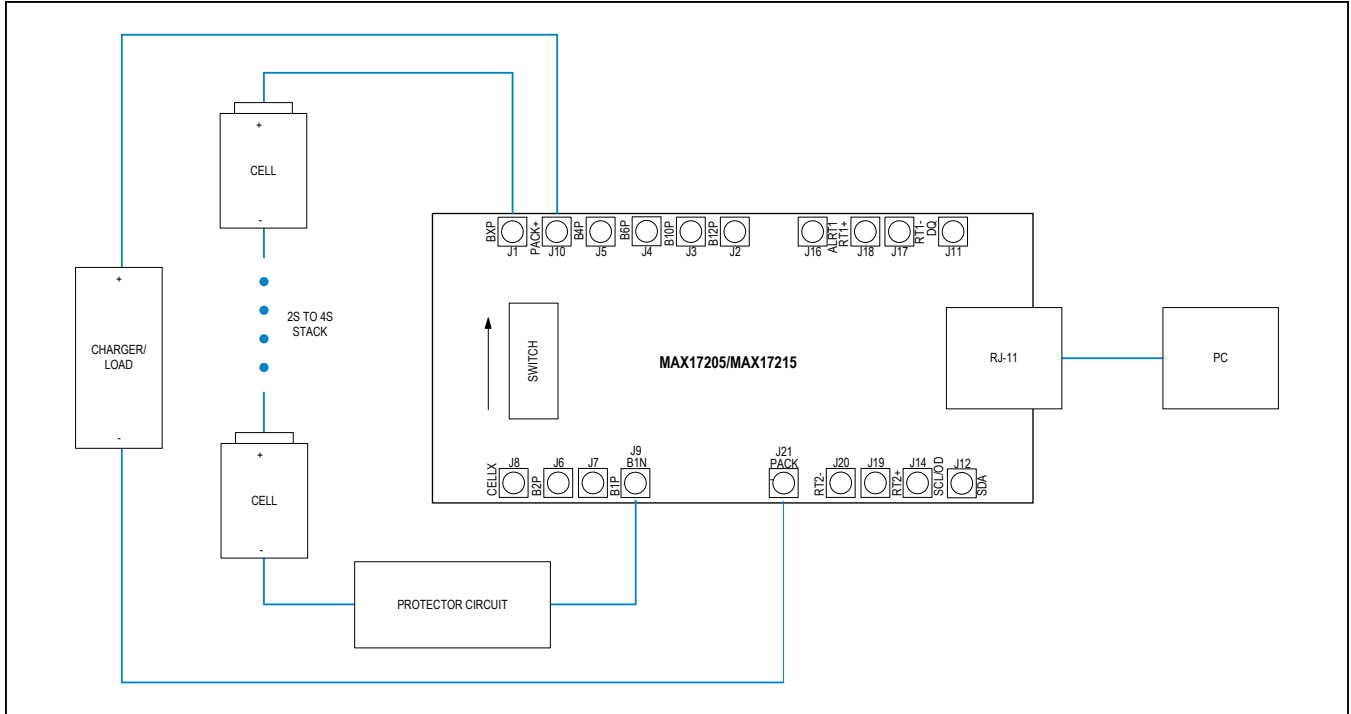

Figure 4. MAX17205/MAX17215 Board Connections for 2S to 4S Cell Stacks with Protector

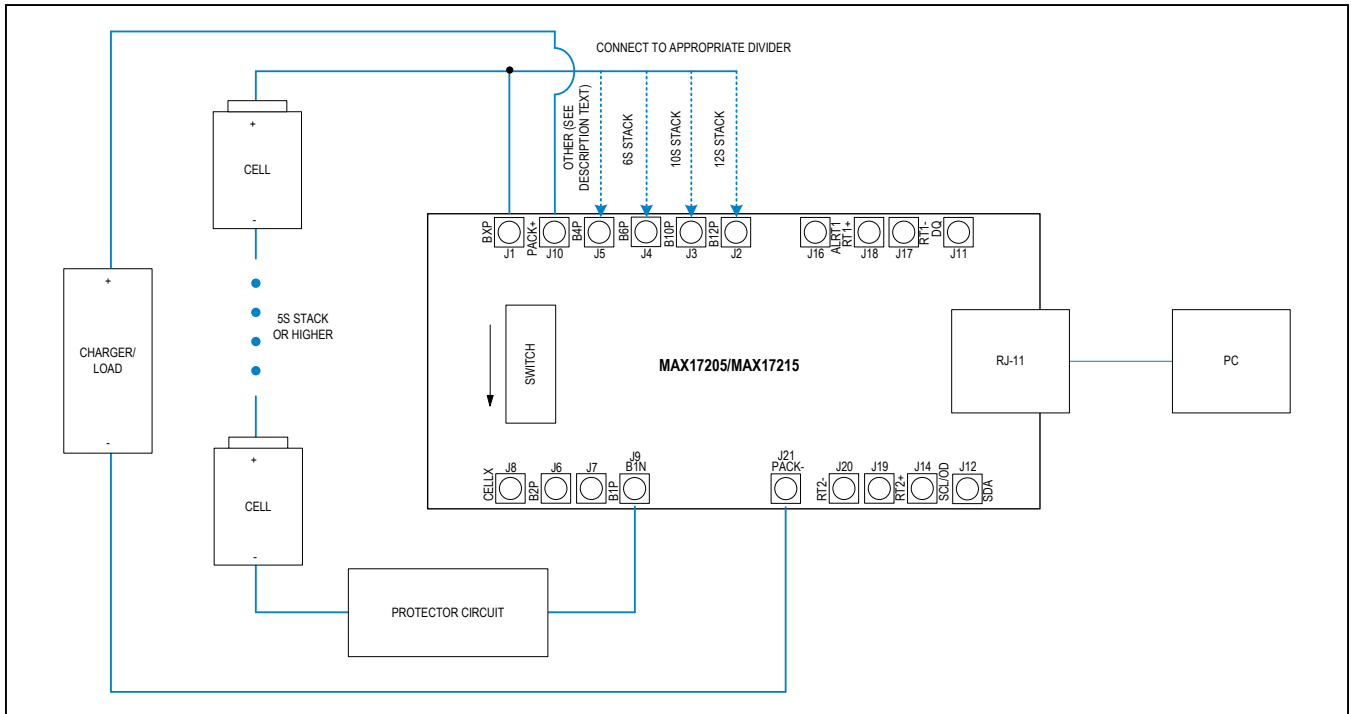

Figure 5. MAX17205/MAX17215 Board Connections for 5S or Larger Cell Stacks

Detailed Description of Hardware

The MAX17201/MAX17205/MAX17211/MAX17215 EV kit boards provide a variety of features that highlight the functionality of the ICs. The following sections detail the most important aspects of the kit boards.

Switch Setting (MAX17205/MAX17215 Only)

The mechanical switch labelled SW1 on MAX17205/MAX17215 boards configures the voltage measurement inputs depending on the number of cells in the cell stack. When the switch is in the “2S to 4S” configuration, all voltage measurement pins are direct inputs to the IC. Resistors on CELL1 and CELL2 pins set the balancing current if cell balancing is enabled.

When SW1 is set to “multicell”, the V_{BATT} pin voltage is limited to 18V maximum by an on-board regulator. The CELLx pin is connected to a resistive voltage divider to allow for the measurement of higher pack voltages. CELL2 controls the resistive voltage divider network to limit current and CELL1 is grounded and unused. [Table 1](#) summarizes the settings for switch SW1. Note that regardless of switch setting, the IC must also be configured properly for the number of cells attached. See the [Configuration Wizard](#) section for details.

Regulator (MAX17205/MAX17215 Only)

When operating the board with a very high cell count (SW1 set to Multicell), a simple regulator circuit limits the voltage on the V_{BATT} pin to 18V. This regulator adds only a small amount of leakage current to the total circuit current load. The regulator can safely handle an input voltage of up to 60V.

Table 1. MAX17205/MAX17215 Switch Setting

SWITCH POSITION	V_{BATT} PIN	CELL1 PIN	CELL2 PIN	CELLx PIN
2S to 4S	Direct input	Direct input with balancing resistor	Direct input with balancing resistor	Direct input
Multicell	Regulated to 18V or lower	Ground	Resistive voltage divider control	Resistive voltage divider network

Precision Resistive Voltage Divider (MAX17205/MAX17215 Only)

When operating the board with a very high cell count (SW1 set to multicell) the CELLx pin is connected to an external precision resistive voltage divider network to measure high voltage cell packs. The divider network has multiple connection points to properly divide the cell stack voltage for 4S, 6S, 10S, or 12S cell stacks. To measure other pack configurations, connect the cell stack to the B4P input and select a value for R5 using the following equation: $0.5M\Omega \times (N - 1)$ where N is the number of cells in the stack. 0.1% tolerance resistor are recommended.

The divider resistors have 0.1% tolerance ratings to have minimal impact on the accuracy of the CELLx measurement. The CELL2 pin controls an external FET to enable the resistor divider only during voltage measurement to limit current drain.

Cell Balancing Resistors (MAX17205/MAX17215 Only)

When operating the board with a 2S or 3S cell stack (SW1 set to 2S to 4S), the CELL1 and CELL2 pins provide direct input measurement of the middle voltage levels of the cell stack. CELL1 and CELL2 also shunt current to balance the cell's voltage levels if cell balancing is enabled. R10 and R11 control the balancing current in this mode. The default values of 100 Ω set the balancing current to ~40mA (~20mA for the middle cell of a 3S configuration). See the [Cell Balancing](#) section of the MAX17201/MAX17205/MAX17211/MAX17215 data sheet for further details.

MAX17201/MAX17205/MAX17211/ MAX17215 Evaluation Kits

Evaluates: MAX17201/MAX17205/ MAX17211/MAX17215

Communication Connections

The RJ-11 connector provides all signal lines necessary for I²C, SMBus, 1-Wire, or 1-Wire overdrive communication between the IC and the software GUI interface. When developing code separately, connections to the communication lines can be made directly to the board. [Table 2](#) summarizes the connections that should be made. The user must apply the appropriate external pullup resistors to the communication lines when not using the DS91230+ communication interface.

External Thermistors

The MAX17201/MAX17205/MAX17211/MAX17215 can be configured to use up to two external thermistors. All EV kit boards come with these thermistors installed as surface mount components RT1 and RT2. If the application requires direct thermal contact to the cells, RT1 and

RT2 can be removed and replaced with leaded thermistors connected between the RT1+/RT1- and RT2+/RT2- solder pads.

Sense Resistor Options

All EV kit boards are shipped with an 0805 size 0.010 Ω chip sense resistor installed. Oversized land pattern pads allow for different size sense resistors to be used if desired. Also, each board contains an optional 0.003 Ω copper trace sense resistor that can be enabled if desired. To do so, the chip sense resistor must be removed and 0 Ω jumpers must be resoldered to change the circuit. [Table 3](#) and [Table 4](#) summarize the changes for each board type. Note that the IC must be reconfigured to support the new resistor type. See the [Configuration Wizard](#) section for details.

Table 2. Communication Line Solder Points

COMMUNICATION MODE	MAX17201 J7	MAX17201 J8	MAX17205 J14	MAX17205 J11	MAX17211 J7	MAX17211 J8	MAX17215 J14	MAX17215 J11
I ² C	SCL	SDA	SCL	SDA	N/A	N/A	N/A	N/A
1-Wire	N/A	N/A	N/A	N/A	Logic-low	DQ	Logic-low	DQ
1-Wire Overdrive	N/A	N/A	N/A	N/A	Logic-high	DQ	Logic-high	DQ

Table 3. Sense Resistor Selection for MAX17201/MAX17211

COMPONENT	VALUE FOR CHIP SENSE	VALUE FOR BOARD TRACE SENSE
R13	0 Ω	Not populated
R14	Not populated	0 Ω
R15	Desired sense value	Not populated
R16	Not populated	0 Ω (R17 is trace resistor)

Table 4. Sense Resistor Selection for MAX17205/MAX17215

COMPONENT	VALUE FOR CHIP SENSE	VALUE FOR BOARD TRACE SENSE
R23	0 Ω	Not populated
R24	Not populated	0 Ω
R20	Desired sense value	Not populated
R21	Not populated	0 Ω (R22 is trace resistor)

MAX17201/MAX17205/MAX17211/ MAX17215 Evaluation Kits

Evaluates: MAX17201/MAX17205/ MAX17211/MAX17215

Detailed Description of Software

The MAX17201/MAX17205/MAX17211/MAX17215 evaluation kit software gives the user complete control of all functions of the MAX17201/MAX17205/MAX17211/MAX17215, as well as the ability to load a custom model into the ICs. It also comes with a sophisticated Configuration wizard to allow user to easily adjust fuel gauge settings. Separate control tabs allow the user access to view real-time updates of all monitored parameters. The software also incorporates a data-logging feature to monitor a cell over time.

Software Installation

The software requires Windows 7 or newer operating system. .NET version 4.5 is required for operation and is automatically installed if an older version of .NET framework is detected. To install the evaluation software, exit all programs currently running and unzip the provided MAX17201_05_11_15K Installation Package zipped file. Double click the MAX17201_05_11_15K_V_x_x_x_x Install.exe icon and the installation process begins. Follow the prompts to complete the installation. The evaluation software can be uninstalled in the Add/Remove Programs tool in the Control Panel. After the installation is complete, open the Maxim Integrated/MAX17201_05_11_15K folder and run MAX17201_05_11_15K.exe or select it from the

program menu. Figure 6 shows a splash screen containing information about the evaluation kit that appears as the program is being loaded.

Communication Port

The EV kit software automatically finds the DS91230+ adapter when connected to any USB port. Communication status is shown on the right-hand side of the bottom status bar. See Figure 7. If the adapter cannot be found, a “No USB Adapter” message is displayed. If the adapter is found, but the IC daughter board cannot be found, a “No Slave Device” message is displayed. Otherwise, if communication is valid, a green bar updates as the software continuously reads the IC registers.

If the DS91230+ is connected, the status bar should be active. The bottom status bar also displays information on data logging status, the communication mode, hibernation status, selected current-sense resistor value, device serial number, and the EVKIT GUI's version number.

Program Tabs

All functions of the program are divided under eight tabs in the main program window. Click on the appropriate tab to move to the desired function page. Located on the **ModelGauge m5** tab is the primary user information measured and calculated by the IC. The **Graphs** tab visually displays fuel gauge register changes over time.



Figure 6. EV Kit Splash Screen

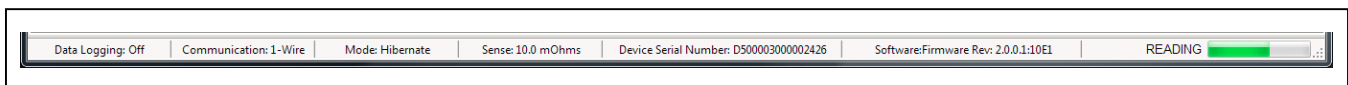

Figure 7. EV Kit Bottom Status Bar

MAX17201/MAX17205/MAX17211/ MAX17215 Evaluation Kits

Evaluates: MAX17201/MAX17205/ MAX17211/MAX17215

The **Registers** and **SBS** registers tabs allow the user to modify common fuel gauge registers one at a time. The **Commands** tab allows for special operations such as changing communication mode, initiate fuel gauge logging and performing fuel gauge reset. The **Configuration** tab displays the value of the nonvolatile registers as well as the remaining number of available writes. The **Authentication** tab displays SHA authentication-related information. The **History** tab allows the user to read out and save battery history information logged by the IC over its lifetime. All tabs are described in more detail in the following sections.

ModelGauge m5 Tab

The **ModelGauge m5** tab displays the important output information read from the IC. [Figure 8](#) shows the format of the ModelGauge m5 Tab. Information is grouped by function and each is detailed separately.

State of Charge

The **State of Charge** group box displays the main output information from the fuel gauge: state of charge of the cell, remaining capacity, time to full, and time to empty.

Cell Information

The **Cell Information** group box displays information related to the health of the cell such as the cell's age, internal resistance, present capacity, number of equivalent full cycles, and change in capacity from when it was new.

IC Information

The **IC Information** group box displays information related to IC itself. This includes the IC part number, IC unique ROM ID, and IC firmware revision.

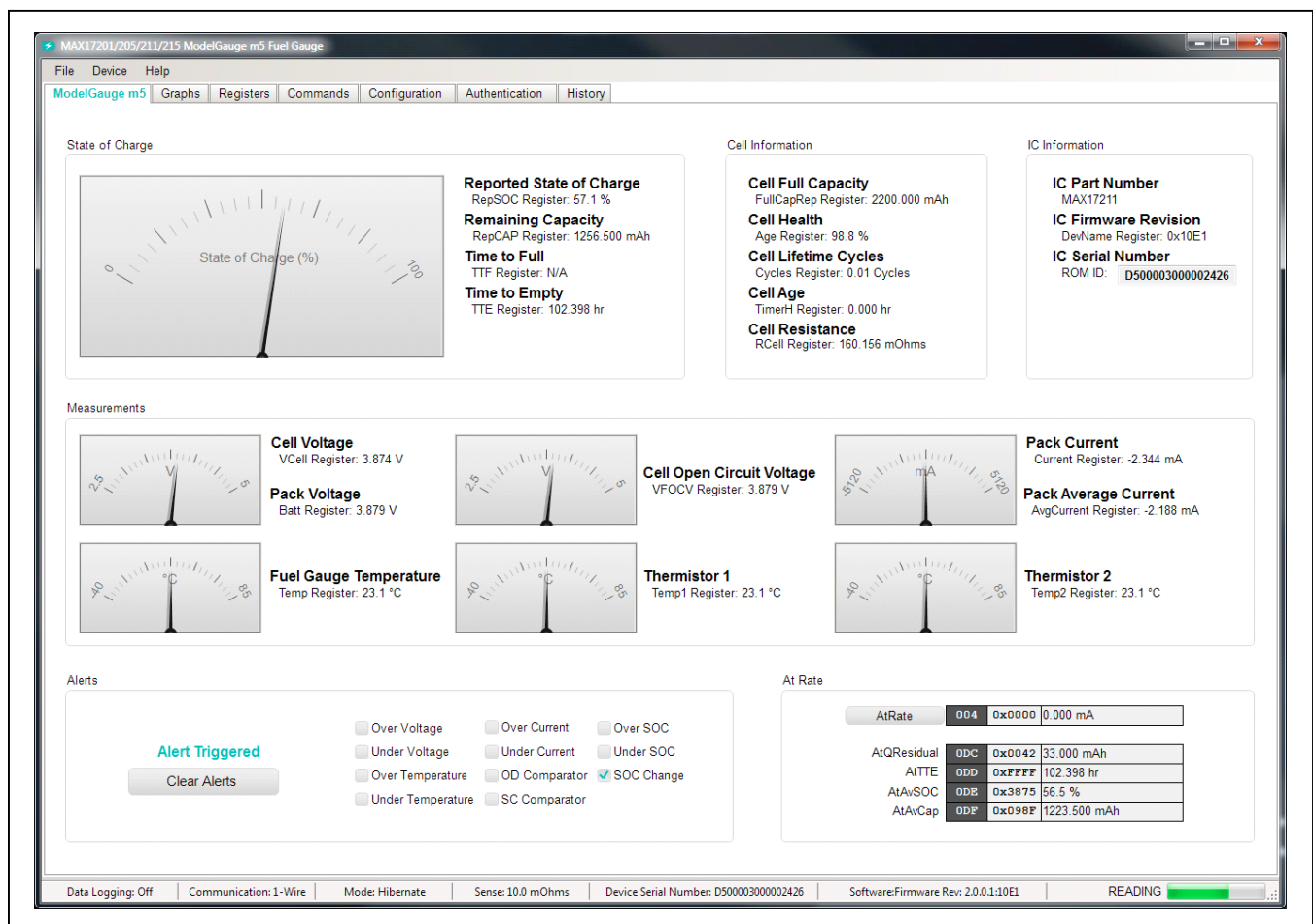

Figure 8. ModelGauge m5 Tab

MAX17201/MAX17205/MAX17211/ MAX17215 Evaluation Kits

Evaluates: MAX17201/MAX17205/ MAX17211/MAX17215

Measurements

The **Measurements** group box displays ADC measurements that are used by the fuel gauge to determine state of charge.

Alerts

The **Alerts** group box tracks all eleven possible alert trigger conditions. If any alert occurs, the corresponding checkbox is checked for the user to see. The clear alerts button resets all alert flags.

At Rate

The **At Rate** group box allows user to input a hypothetical load current and the fuel gauge calculates the corresponding hypothetical Qresidual, TTE, AvSOC, and AvCap values.

Graphs Tab

The **Graphs** tab displays up to 20 ADC readings and fuel gauge outputs. [Figure 9](#) shows the format of the **Graphs** Tab. Graph information is grouped into four categories: voltages, temperatures, capacities, and currents. The user can turn on or off any data series using the check boxes on the right-hand side of the tab. The graph visible viewing area can be adjusted from 10 minutes up to 1 week. The graphs remember up to 1 week worth of data. If the viewing area is smaller than the time range of the data already collected, the scroll bar below the graphs can be used to scroll through graph history. All graph history information is maintained by the program. Graph settings can be changed at any time without losing data.



Figure 9. Graphs Tab

Registers Tab

The **Registers** tab allows the user access to all fuel gauge related registers of the IC. [Figure 10](#) shows the format of the **Registers** tab. By using the two buttons on the left side of the tab, the user can sort the registers either by function or by their internal address. Each line of data contains the register name, register address, hexadecimal

representation of the data stored in the register, and if applicable a conversion to application units. To write a register location click on the button containing the register name. A pop-up window allows the user to enter a new value in either hexadecimal units or application units. The main read loop temporarily pauses while the register updates.

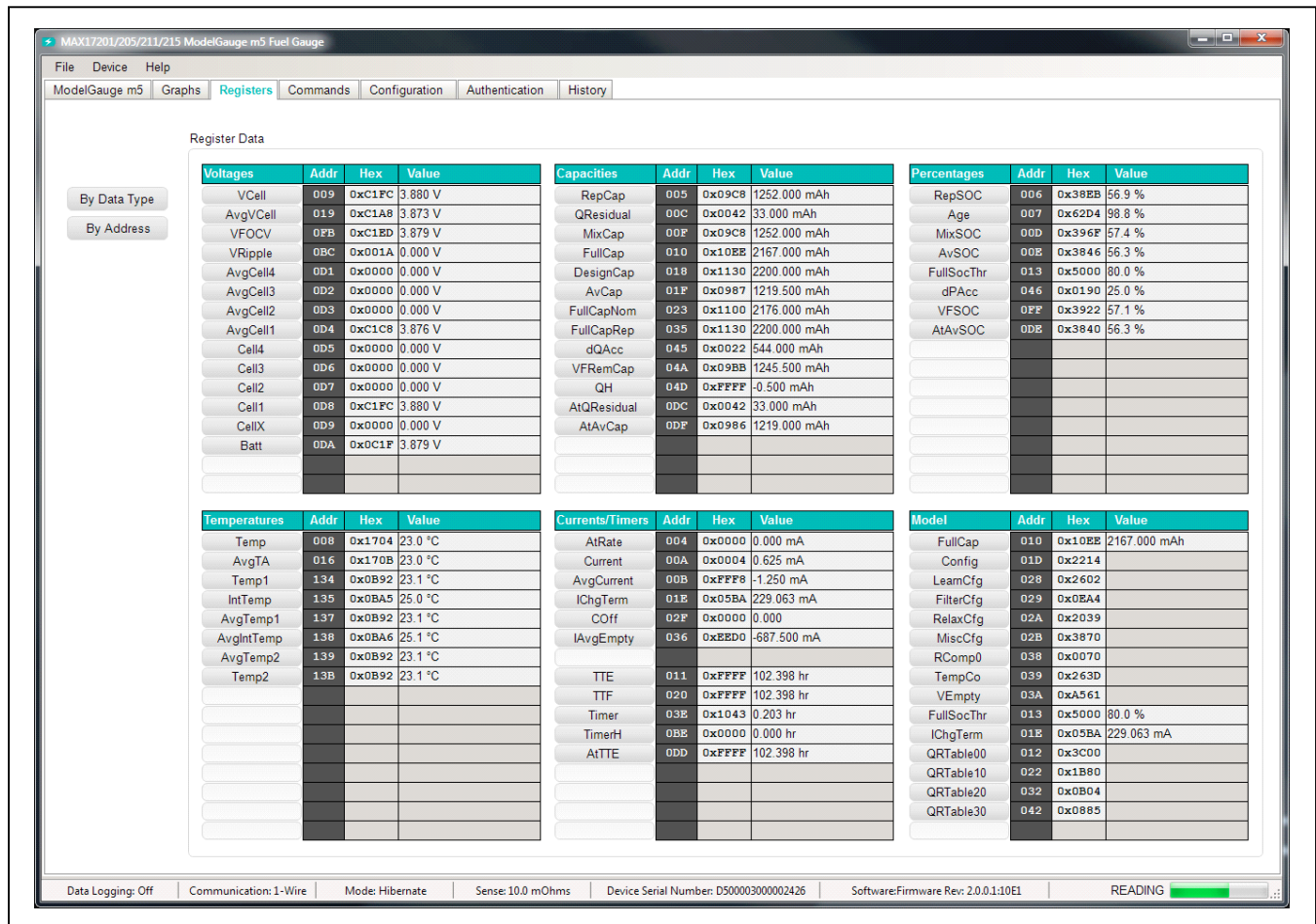

Figure 10. Registers Tab

MAX17201/MAX17205/MAX17211/ MAX17215 Evaluation Kits

Evaluates: MAX17201/MAX17205/ MAX17211/MAX17215

SBS Registers Tab

The **SBS** registers tab is visible only if SBS functions of the IC are enabled. The **SBS** registers tab has the same formatting as the standard **Registers** tab as shown in [Figure 11](#). By using the two buttons on the left side of the tab, the user can sort the registers either by function or by their internal address. Each line of data contains the register

name, register address, hexadecimal representation of the data stored in the register, and if applicable a conversion to application units. To write a register location click on the button containing the register name. A pop-up window allows the user to enter a new value in either hexadecimal units or application units. The main read loop temporarily pauses while the register updates.

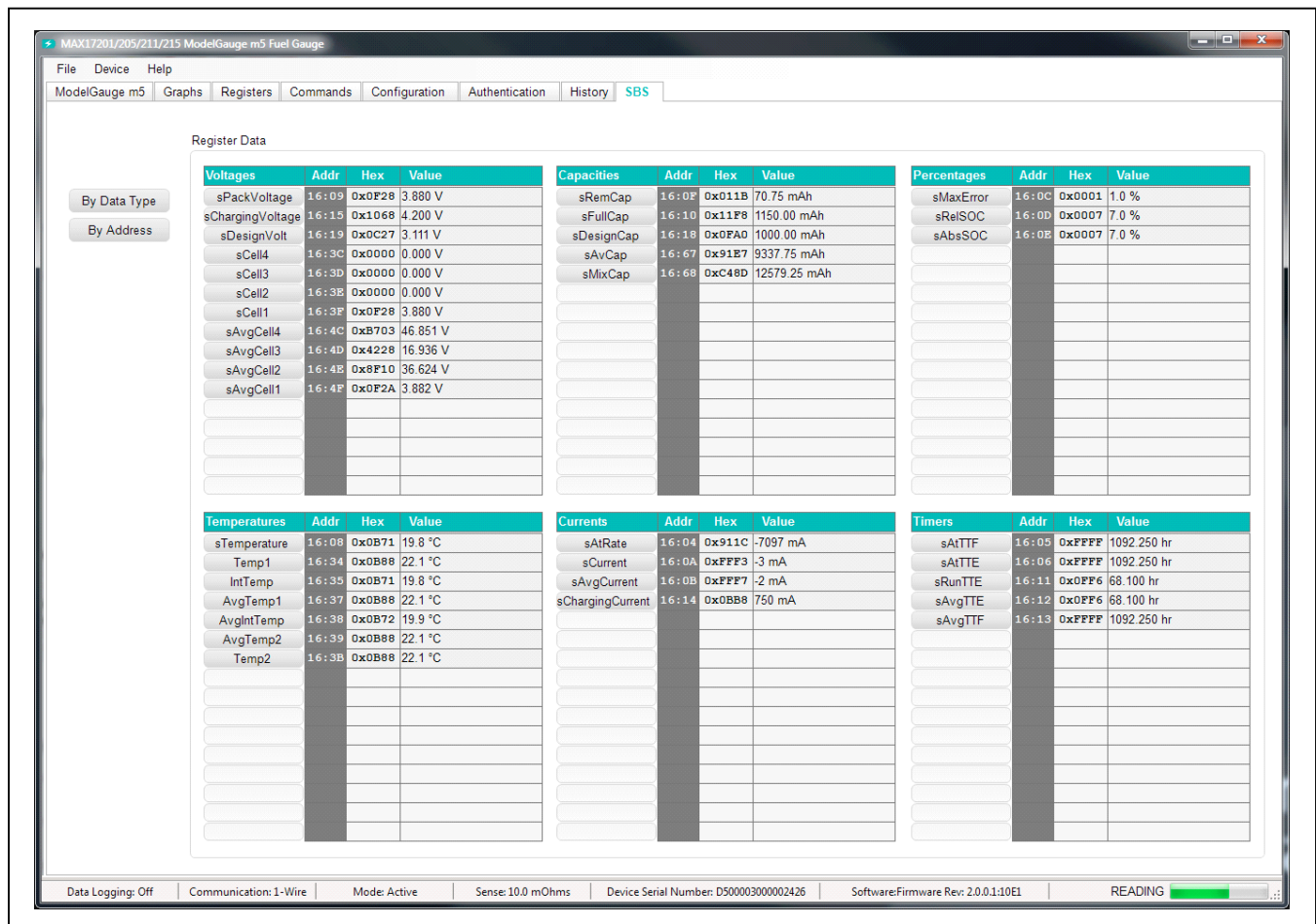

Figure 11. SBS Registers Tab

Commands Tab

The **Commands** tab allows the user to access any general IC functions not related to normal writing and reading of register locations. [Figure 12](#) shows the format of the **Commands** tab. Each group box of the **Commands** tab is described in detail in the following sections.

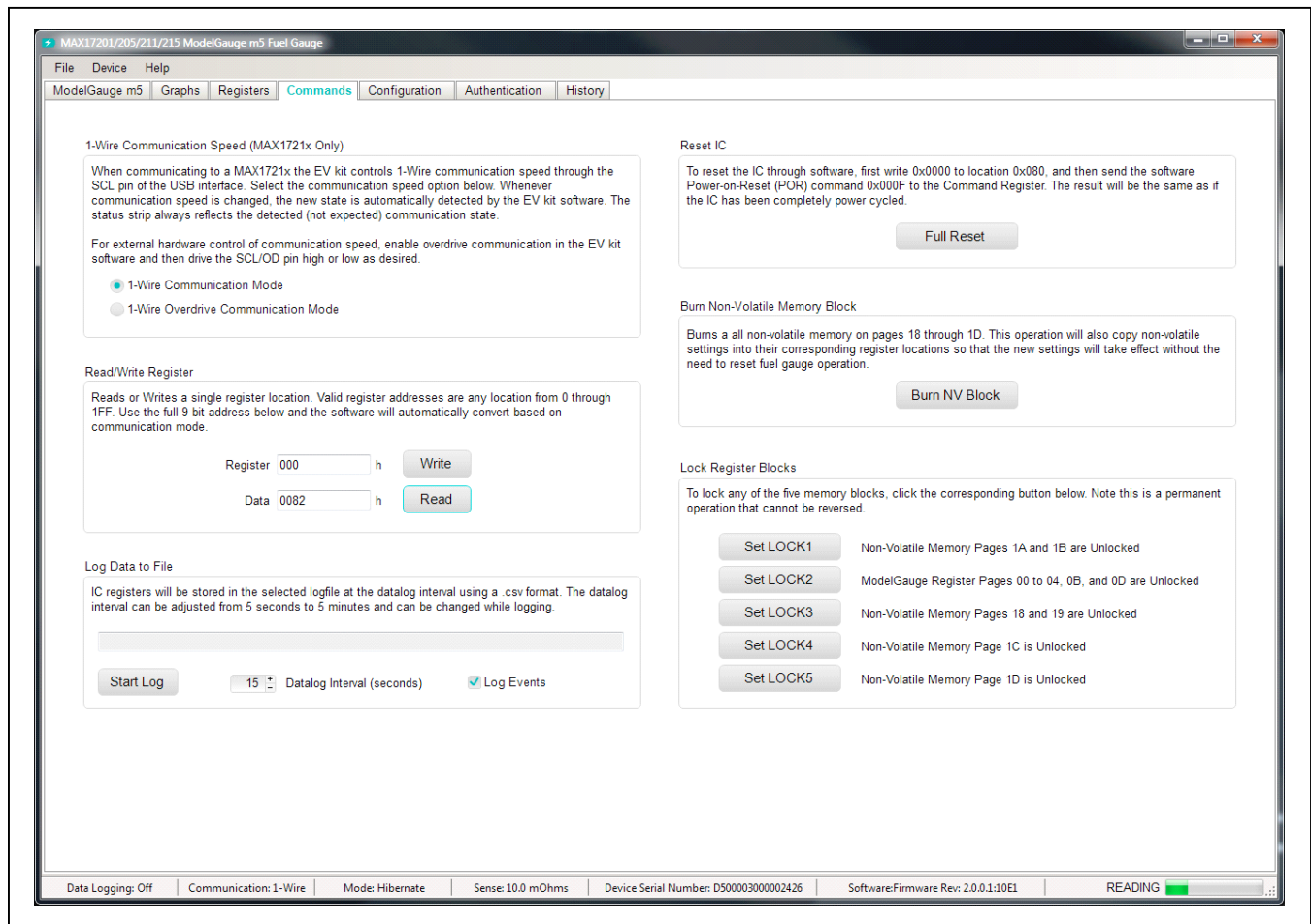

Figure 12. Commands Tab

1-Wire Communication Speed

This option affects 1-wire ICs only. The user can select either standard or overdrive communication speed. Communication speed is controlled by the EV kit software by driving the OD pin of the IC high or low. Regardless of the desired communication rate, the kit software communicates with any IC it discovers at either communication speed. The actual communication speed is displayed in the bottom status bar of the EV kit window.

Read/Write Register

The user can read a single register location by entering the address in hex and clicking the **Read** button. The user can write a single register location by entering the address and data in hex and clicking the **Write** button. The read loop is temporarily paused each time to complete this action.

Log Data to File

The user can log IC register information to file by clicking the **Start Log** button. The user is prompted to select a filename at this time. Whenever data logging is active, it is displayed on the bottom status bar of the EV kit window. All user available IC registers are logging in a .csv formatted file. The user can adjust the logging interval at any time. The user can also enable or disable the event logging at any time. When event logging is enabled, the data log also stores any IC write or reads that are not part of the normal read data loop and indicates any time communication to the IC is lost.

Burn Nonvolatile Memory Block

Clicking the **Burn NV Block** button sends the Copy NV Block command to the command register that causes all register locations from 180h to 1DFh to be stored to nonvolatile memory. Nonvolatile memory has a limited number of copies and the user is prompted to confirm prior to executing the copy.

Reset IC

Clicking the **Full Reset** button sends the software POR command to the command register and sets the POR_CMD bit of the Config2 register to fully reset operation the same as if the IC had been power cycled. Note that resetting the IC when the cell is not relaxed causes fuel gauge error.

Lock Register Blocks

Clicking one of the five lock buttons locks a page or pages of memory as listed to the right of each button. This is a permanent operation so the user is prompted to confirm the operation prior to setting the lock.

Configuration Tab

The **Configuration** tab has similar formatting to the standard **Registers** tab as shown in [Figure 13](#), but there are some major differences. When the user changes a register value on the **Configuration** tab, only the RAM value of that location is changed. The nonvolatile value remains unchanged. Register text changes to **BLUE** to indicate the RAM and nonvolatile values do not match. The user must complete a nonvolatile burn on the **Commands** tab or run the Configuration Wizard to change the nonvolatile value.

The nonvolatile memory has a limited number of updates that is shown in a box on the left-hand side of the tab. Maxim recommends using the Configuration Wizard to make any changes to nonvolatile memory instead of changing registers manually. The wizard can be launched through the **Device** drop-down menu at the top of the EV kit software window or by the button on the left-hand side of the **Configuration** tab. See the [Configuration Wizard](#) section for details.

Note any register information that is displayed in **RED** text indicates a nonvolatile burn error where the data read back after a burn does not match the expected value.

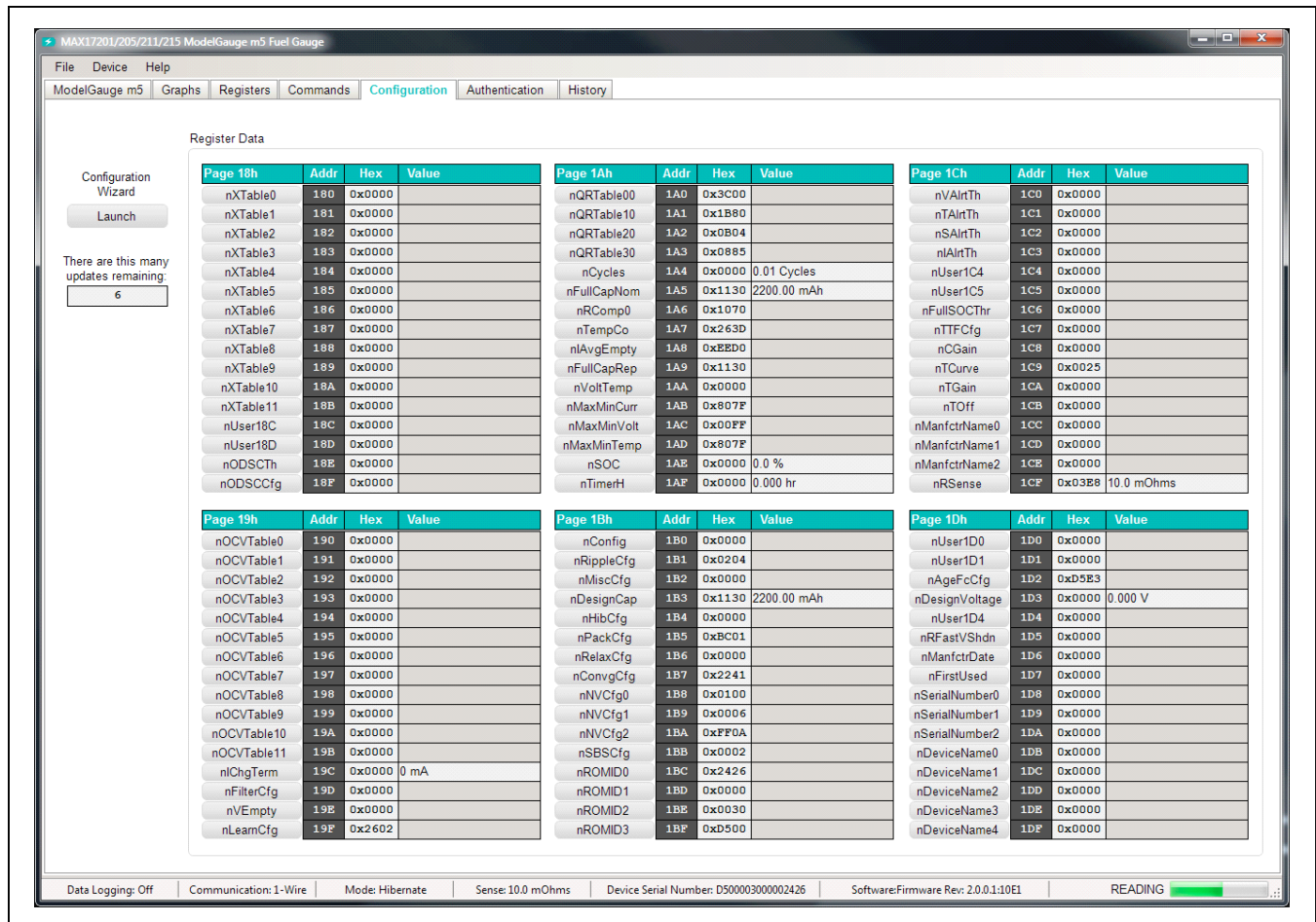

Figure 13. Configuration Tab

Authentication Tab

The **Authentication** tab allows the user to perform any action related to the SHA 256 authentication feature of the IC. Figure 14 shows the format of the **Authentication** tab. Each group box of the **Authentication** tab is described in detail in the following sections.

SHA Challenge/ROM ID

Enter values into the challenge registers directly or click the **Randomize Challenge** button to fill the challenge registers with a completely random value. The challenge value is not written to the IC until one of the **Compute MAC** buttons is clicked. The ROM ID is used in some SHA calculations so it is displayed here for reference.

SHA Secret

Enter the secret value here to allow software to verify the SHA calculations of the IC. The EV kit software updates

these values after a compute next secret command to what it believes the secret value should be. The secret value cannot be written directly or read from the IC. The secret value has a limited number of updates that are displayed in the changes remaining box. Note that once the secret is locked or if the number of remaining updates reaches 0, it can no longer be changed.

SHA Authentication Results

After a SHA operation occurs, the output is displayed in the **Reported MAC** column. The EV kit software calculates its own hash and displays the result in the **Expected MAC** column. If the results match, the operation is a success. If the results do not match, it is most likely because the secret inside the IC does not match the secret value entered into the EV kit software.

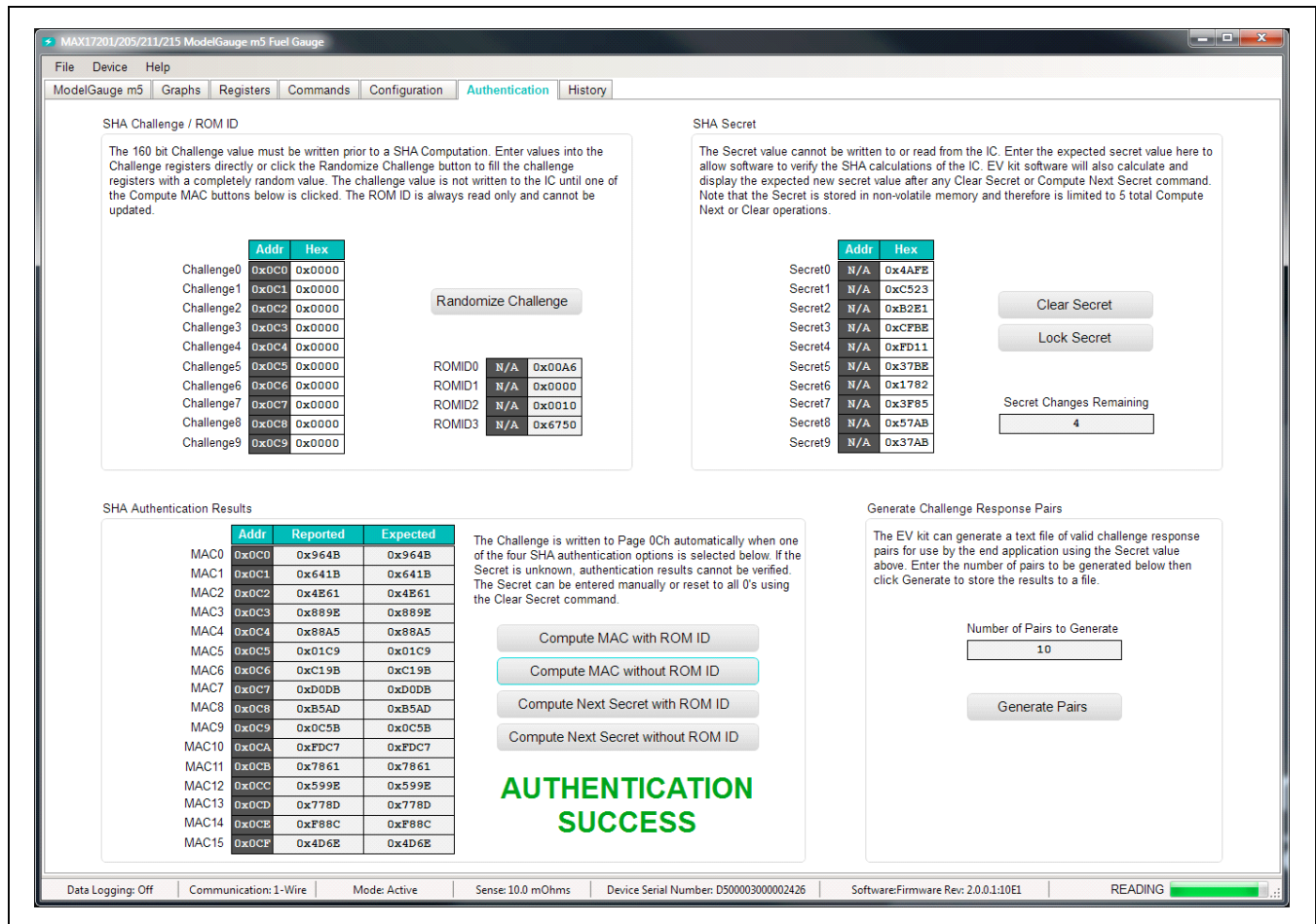

Figure 14. Authentication Tab

Generate Challenge/Response Pairs

Some applications use challenge-response pairs to confirm battery pack authenticity instead of maintaining the secret on the host side. The EV kit software can generate a file of any length of random challenge-response pairs for use by the application. Ensure to have the correct secret entered before generating the pairs.

History Tab

The **History** tab allows the user to see all battery history logging information stored inside the IC. When the EV kit software is loaded, this page is blank. History information is not automatically read from the IC. The user must click either the **Read Battery History** button to display history data or the **Read History and Save to File** button to store history data in a tab delimited .csv file and then display the data. After history data has been read from the IC,

it is displayed to the user starting with page 1. [Figure 15](#) shows the history tab format.

Each history page has a status of “BLANK” if it has not yet been written, “WRITTEN” if it contains good history data, or “SKIPPED” if the IC experienced a write error while storing the data. Each history page contains 16 words of data. The user can click through each of the 203 history pages or enter a page number directly into the box to jump to a certain page.

If a page has been written, all page data is displayed as hexadecimal values. Some history information can be converted into application units. Those locations contain one or two additional boxes of information showing the converted values. Value boxes can display “User Data” if that location has been configured to store user data instead of history information or “A.F. Data” if that location is being used for cycle+ age forecasting information.

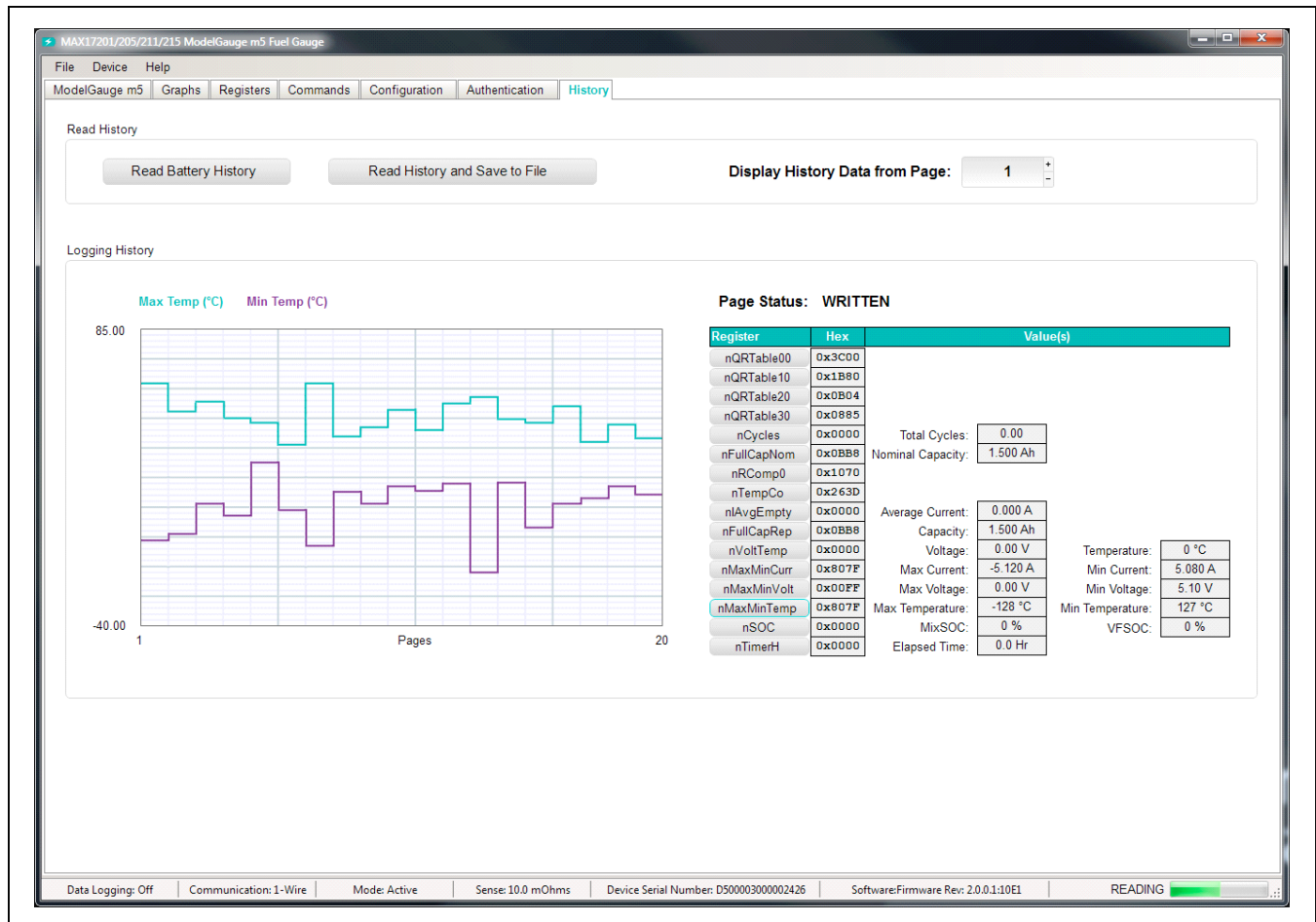

Figure 15. History Tab

The history information is also displayed in a graph on the left side of the tab. The graph displays data only from history pages that have been written by the IC. Click on the corresponding register name button to change the data shown by the graph.

ModelGauge m5 EZ Configuration

Before the IC accurately fuel gauges the battery pack, it must be configured with characterization information. This can be accomplished two ways.

The first is through a custom characterization procedure that can be performed by Maxim under certain conditions. The result is an .INI summary file that contains

information that can be programmed into the IC using the **Configuration Wizard** tool. Contact Maxim for details on this procedure.

The second method is ModelGauge m5 EZ configuration. This is the default characterization information shipped inside every IC. This default model produces accurate results for most applications under most operating conditions. It is the recommended method for new designs as it bypasses the custom cell characterization procedure. Some additional information is required from the user for EZ configuration initialization. The **Configuration Wizard** tool handles this as well.

Configuration Wizard

The EV kit software contains a fuel gauge Configuration Wizard that can be launched either on the **Configuration** tab or from the **Device** drop-down menu. The Configuration Wizard is the recommended way to change any nonvolatile settings inside the IC. The wizard allows user to:

- Open a custom INI file or generate a ModelGauge m5 EZ configuration.
- Make any adjustments specific to the application.
- Load the final configuration into the IC.
- Export the generated configuration to a new INI file.

The Configuration Wizard walks users through an 18 step process to configure the IC. [Figure 16](#) shows the first page of the wizard. Each step is detailed below. The user

can click the previous button in the bottom left corner of any page to return to any previous step if desired. Once the last step is completed, the wizard closes, the IC is configured, and a new INI file is saved (if selected).

Step 1: Starting the Template

Choose between the existing nonvolatile memory data already inside the IC or revert back to the factory default values (ModelGauge m5 EZ).

Step 2: Cell Model Selection

Choose between existing model already in the IC's non-volatile memory, the ModelGauge m5 EZ model, or a custom model from an INI file by using the **Select File** button. Note that ModelGauge m5 EZ is recommended if a custom model is not available.

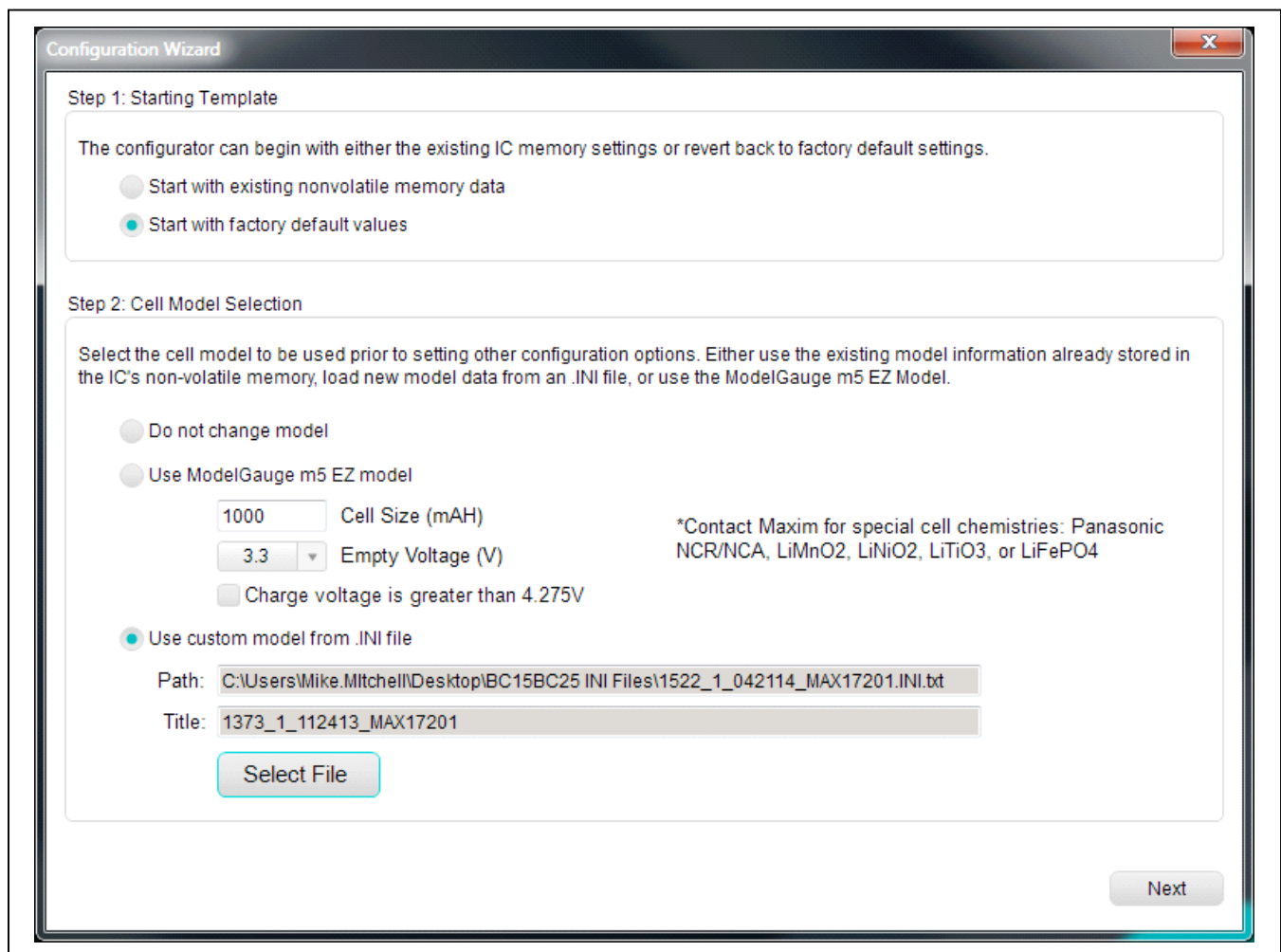

Figure 16. Configuration Wizard Steps 1 and 2

Step 3: General Pack Configuration

Select the configuration that most closely resembles the application circuit. The choice made in step 3 determines which options are available in step 4 as certain functions and ADC channels are not available in certain pack configurations.

Step 4: Specific Pack Configuration Details

Select the number of series cells in the pack configuration as well as which ADC channels are used to measure pack voltages. If Multicell Inside Protector configuration was selected in step 3, cell balancing is possible. The cell balancing threshold can be selected from the drop-down box. If the application has more than 15 cells in series, contact Maxim about configuration options.

Step 5: Shutdown Mode

Select the checkbox if the user intends for the IC to enter shutdown mode any time the battery pack is removed from the application (communication lines low).

Step 6: SBS Compliant Functionality

Select the checkbox if user intends to use IC in smart battery system (SBS) compliant mode. If SBS mode is not used, these device registers are available for general-purpose data storage in step 16. If SBS mode is enabled, all SBS-related configuration settings can be adjusted here.

Step 7: Sense Resistor Selection

Choose the value of the sense resistor to be used in the application. Also, select the resistor temperature compensation. Maxim recommends disabling temperature compensation when using a chip sense resistor. If using a PCB signal trace as the sense resistor, the default temperature coefficient value of 0.4% per °C is ideal for copper.

Step 8: Current Measurement Calibration (Optional)

Current measurement gain calibration is not required for proper operation of the fuel gauge. Perform this operation calibration step only if the application requires it. To calibrate current, first force a known current of at least one half the full-scale value through the sense resistor and enter that value into the **Forced Current** text box. When the Current register and AvgCurrent register readings become stable, the **Auto Calibrate** button is enabled to allow calibration to occur. Alternatively, the user can adjust gain manually by entering a value into the **Gain Adjust** text box. The default value for gain adjust is 1.000 or 100%.

Step 9: Temperature Measurement Channels

Select which temperature measurements are used by the application. Die temperature measurement is recommended for all

applications. Die temperature measurements are enabled by default if no other measurement channels are enabled..

Step 10: Temperature Measurement Details

Selections made in step 9 determine which options are available in this step. The user must select which temperature input is used by the fuel gauge. See the nPack-Cfg register definition for details. If a thermistor channel is enabled then gain, offset, and curve scaling values must be used to convert the ADC reading to temperature. If the application uses a common thermistor type found in the pulldown menu, select that thermistor and the scaling values are automatically populated. If the application does not use one of these common thermistors, select other and enter the scaling values manually.

Step 11: Alert Configuration

Enable the desired alert conditions and then select the desired alert thresholds. Note that the current related alert thresholds scale based on the sense resistor selection from step 7.

Step 12: Overcurrent Detection

Choose the over-discharge (OD) and short-circuit (SC) detection settings for the application. Each can be enabled independently of other alerts. The user then selects a threshold and delay setting. Threshold values scale depending on the sense resistor selection from step 7.

Step 13: ALRT Pin Polarity

Choose between active high and active low for the ALRT pin's polarity. ALRT pin polarity is forced to active low if either OD or SC comparators are enabled.

Step 14: Cycle+ Age Forecasting

Enable age forecasting here and then choose the DeadTargetRatio and CycleStart for the age forecasting function. Note that if age forecasting is enabled, the nVolt-Temp and nSOC registers are used to store age forecasting information and are not available in step 15.

Step 15: Battery Life Logging

Enable or disable any of the registers used for Battery Life Logging. Any unchecked registers not otherwise used by age forecasting are available for general-purpose data storage during step 16. The **Cycles Per Save** box sets the rate at which cell history information is data logged by the IC.

Step 16: General-Purpose Data Storage

Configuration choices in steps 1–15 determine which registers are available for general-purpose data storage. The user can now enter any data they wish into any nongrey register location.

Step 17: Summary of Changes

After all desired nonvolatile configuration settings have been entered by the user, the table in step 17 shows a color-coded summary of how the nonvolatile memory settings are changed by the new configuration. Note the **Configuration Wizard** automatically converts any memory location that matches its alternate default value into general-purpose data storage. This can cause changes to the nNVCfg0 to nNVCfg2 registers not selected by the user, but does not affect IC operation. [Figure 17](#) shows an example of the Configuration Wizard summary table.

Step 18: Update IC and Save New Configuration

In the final step, the user is given options of how to use the new configuration. [Figure 18](#) shows step 18 of the configuration wizard. Option one is to discard all changes which has no effect on the IC. Option two is to write the IC configuration shadow RAM only. This does not use one of the limited nonvolatile copies and does not change

the functional operation of the IC. Option three is to write configuration shadow RAM and then restart firmware so that those changes take effect. This allows the user to experience the new operation of the IC without using one of the limited nonvolatile copies. Finally, option four writes the new configuration to the IC, burns the configuration into nonvolatile memory, and then restarts the IC so those changes take effect. This option is not available if the IC already used up all of the available configuration copies. Additionally, the user can store the new configuration options into a new INI file for easy programming of additional units. Select the desired path name for the new INI file.

The Configuration Wizard completes once the user clicks the **Done** button below step 18. The desired actions from step 18 occur after **Done** is clicked and the wizard closes. Click the window close button in the upper right corner of the wizard to exit at any time without performing any of the actions from step 18.

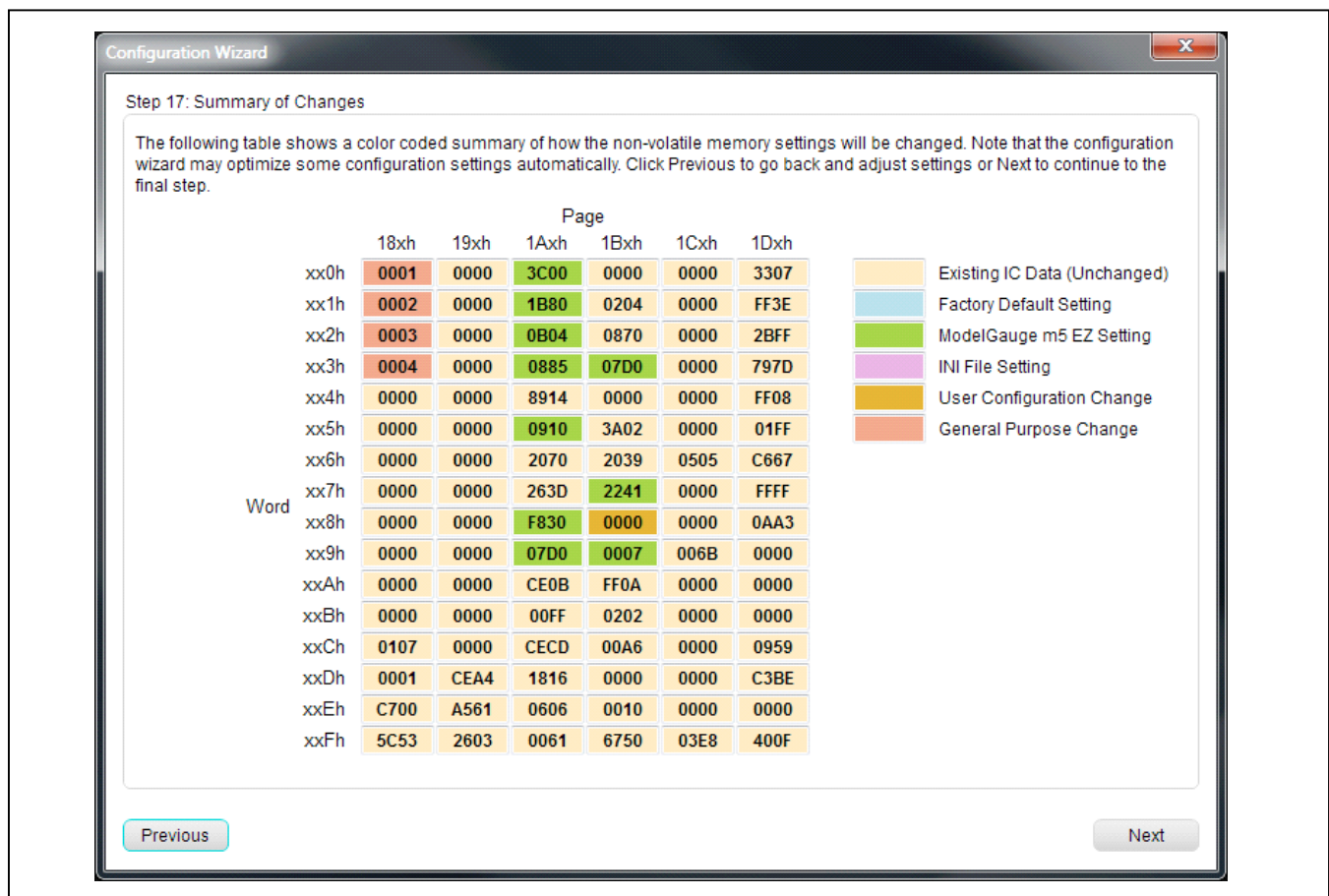

Figure 17. Configuration Wizard Step 17

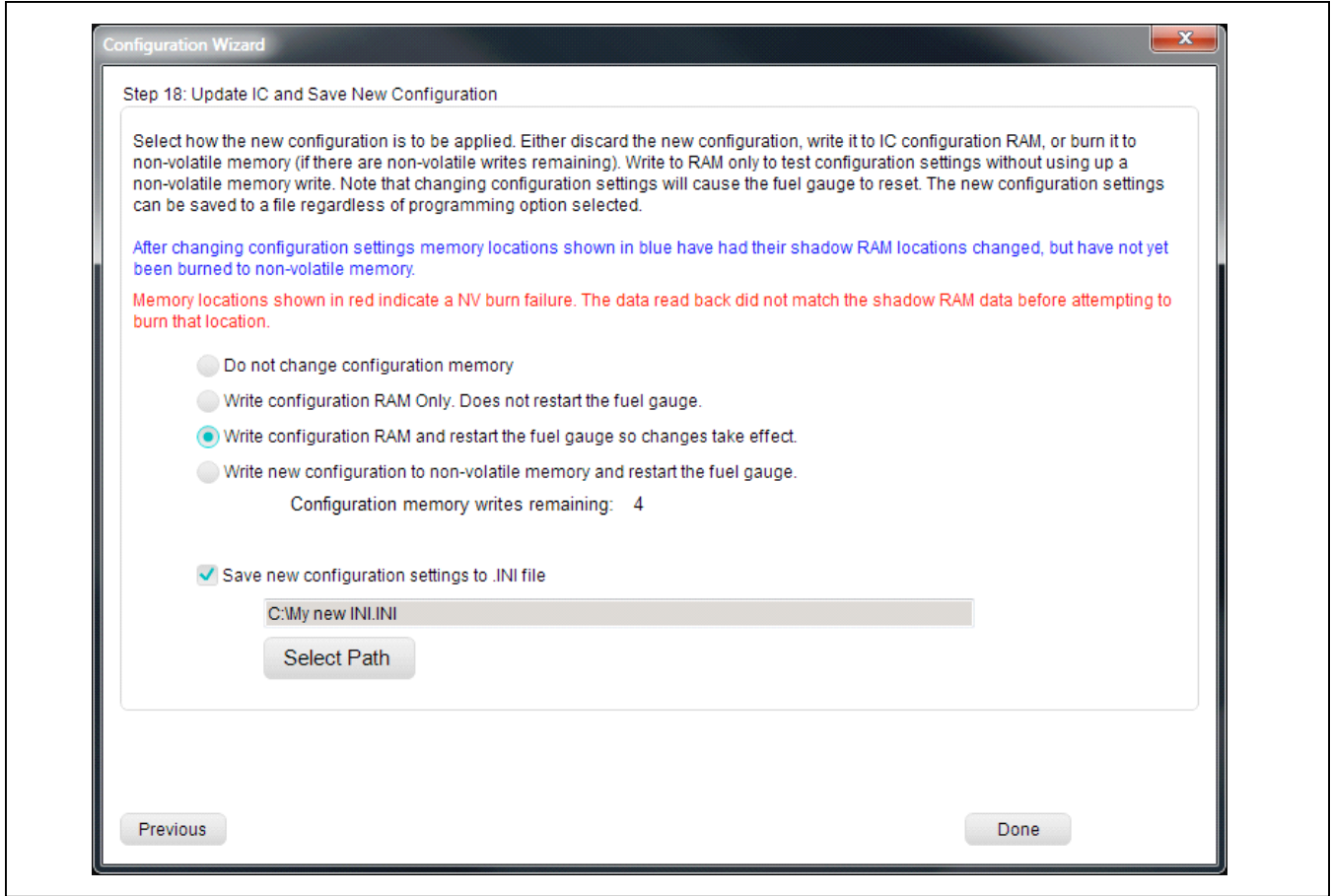

Figure 18. Configuration Wizard Step 18

Component Suppliers

SUPPLIER	PHONE	WEBSITE
Murata Electronics North America, Inc.	770-436-1300	www.murata.com/en-us
TDK Corp.	847-803-6100	www.component.tdk.com
Vishay	402-563-6866	www.vishay.com

Note: Indicate that you are using the MAX17201/MAX17205/MAX17211/MAX17215 when contacting these component suppliers.

Component List, Schematics, and PCBs

See the following links for the components, schematics, and PCBs.

Note the schematic and layout are identical for the MAX17201 and MAX17211 EV kit boards. The only difference between boards is IC type and board name silk-screen. The MAX17201 is shown in the following figures.

Note the schematic and layout are identical for the MAX17205 and MAX17215 EV kit boards. The only difference between boards is IC type and board name silk-screen. The MAX17205 is shown in the following figures.

- [MAX17201/MAX17211 BOM](#)
- [MAX17201/MAX17211 schematics](#)
- [MAX17201/MA17211 PCB](#)
- [MAX17205/MAX17215 BOM](#)
- [MAX17205/MAX17215 schematics](#)
- [MAX17205/MAX17215 PCB](#)

Ordering Information

PART	TYPE
MAX17201GEVKIT#	EV Kit
MAX17205GEVKIT#	EV Kit
MAX17211GEVKIT#	EV Kit
MAX17215GEVKIT#	EV Kit

#Denotes RoHS compliant.

MAX17201/MAX17205/MAX17211/
MAX17215 Evaluation Kits

Evaluates: MAX17201/MAX17205/
MAX17211/MAX17215

Revision History

REVISION NUMBER	REVISION DATE	DESCRIPTION	PAGES CHANGED
0	3/16	Initial release	—

For pricing, delivery, and ordering information, please contact Maxim Direct at 1-888-629-4642, or visit Maxim Integrated's website at www.maximintegrated.com.

Maxim Integrated cannot assume responsibility for use of any circuitry other than circuitry entirely embodied in a Maxim Integrated product. No circuit patent licenses are implied. Maxim Integrated reserves the right to change the circuitry and specifications without notice at any time.

MAX17201 BILL OF MATERIALS REV 0; 2/16

PART	QTY	DESCRIPTION
C1	1	0.1uF ±10%, 50V X7R ceramic capacitor (0402)
C2	1	1000pF ±10%, 50V X7R ceramic capacitor (0402), not populated
C3	1	1000pF ±10%, 50V X7R ceramic capacitor (0402)
C4	1	0.47uF ±10%, 25V X5R ceramic capacitor (0402)
C5, C6	2	0.01uF ±10%, 25V X7R ceramic capacitor (0402)
R1	1	10Ω ±1%, resistor (0402)
R2	1	51.1KΩ ±1%, resistor (0402)
R3	1	50Ω ±1%, resistor (0402), not populated
R4, R5	2	1KΩ ±1%, resistor (0402)
R6-R10	5	150Ω ±1%, resistor (0402)
R11, R12	2	10kΩ ±1%, resistor (0402)
R13	1	0Ω resistor (0402)
R14	1	0Ω resistor (0402), not populated
R15	1	0.010Ω ±1%, resistor (0805)
R16	1	0Ω resistor (0805), not populated
RT1, RT2	2	Thermistor 10K NTC (0402) Murata NCP15XH103F03
D2, D3	2	5.6V Zener Diode (SOD323)
J1-J2, J4-J8, J10-J14	12	Plated through hole solder pad (16g wire)
J9	1	RJ-11,R/A,6-POSITION/6-CONTACTS
J15	1	Exposed copper trace jumper
U1	1	Li+ fuel gauge IC 3x3 TDFN 14 pin
	1	PCB: MAX17201EVKIT/MAX17211EVKIT
	1	USB-to-RJ11 board DS91230+
	1	RJ11 6pos-6pos reverse modular cord 6ft.

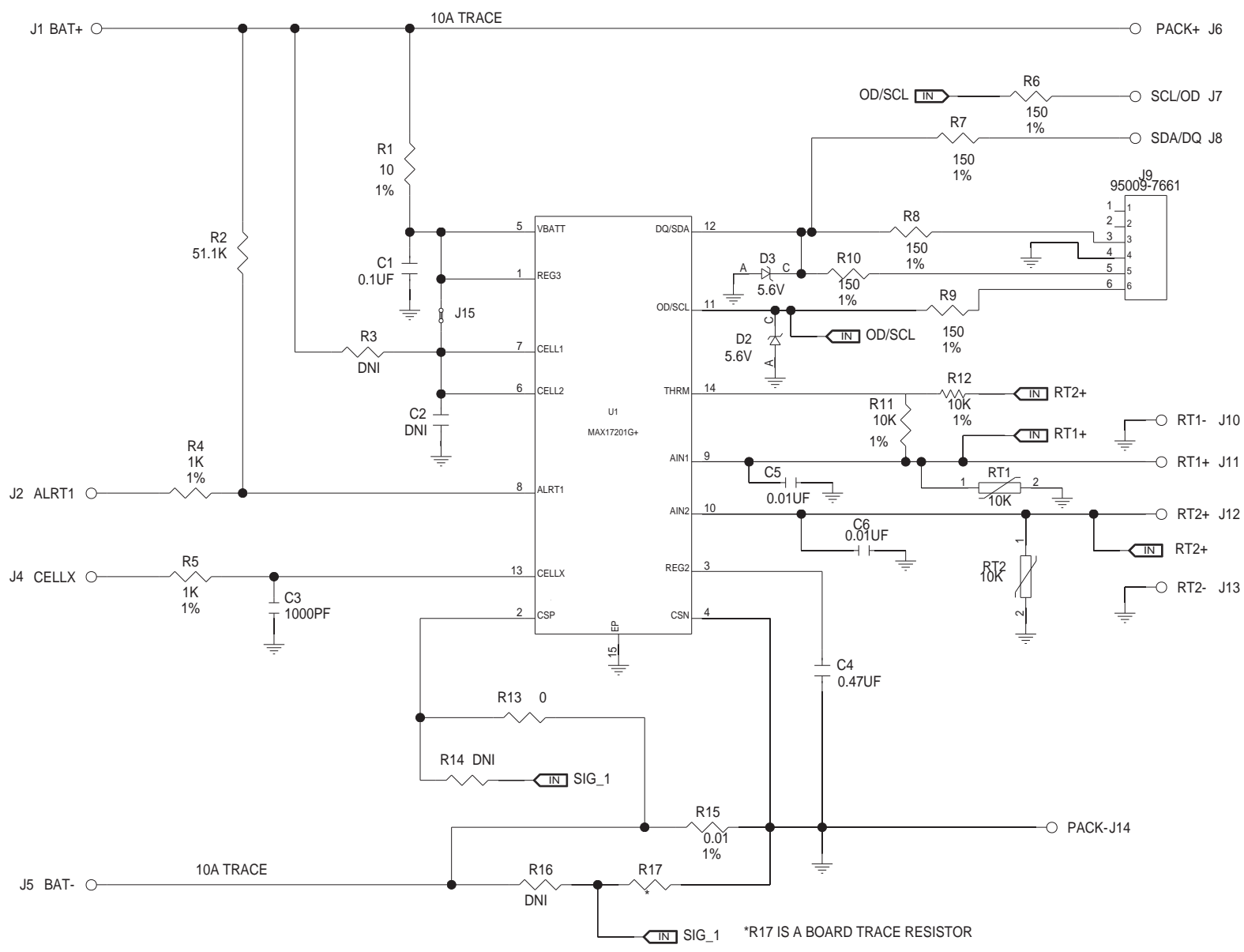

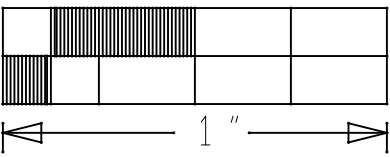
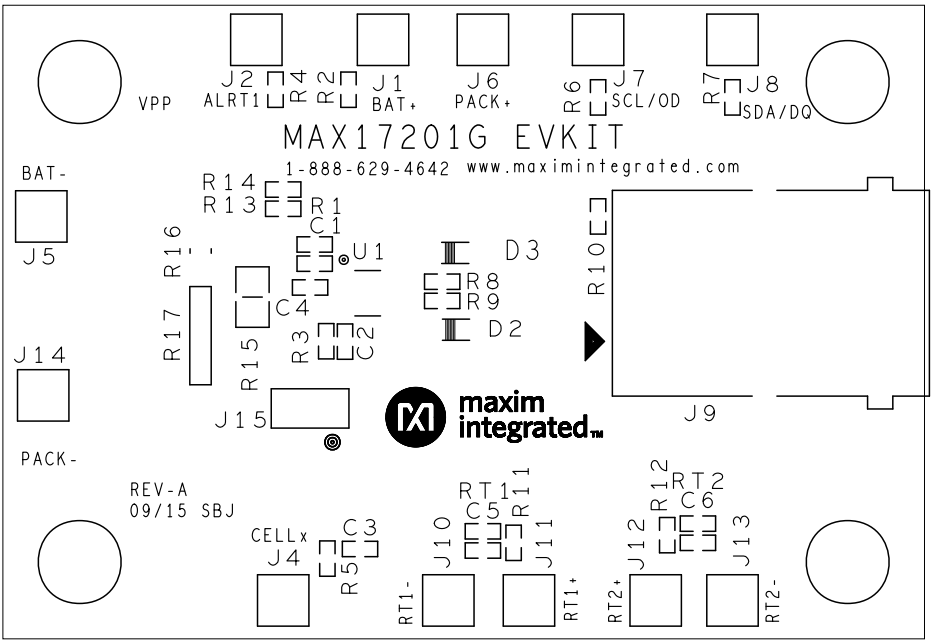

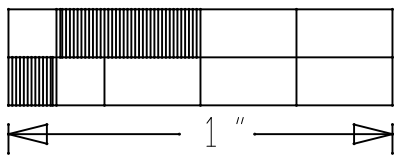
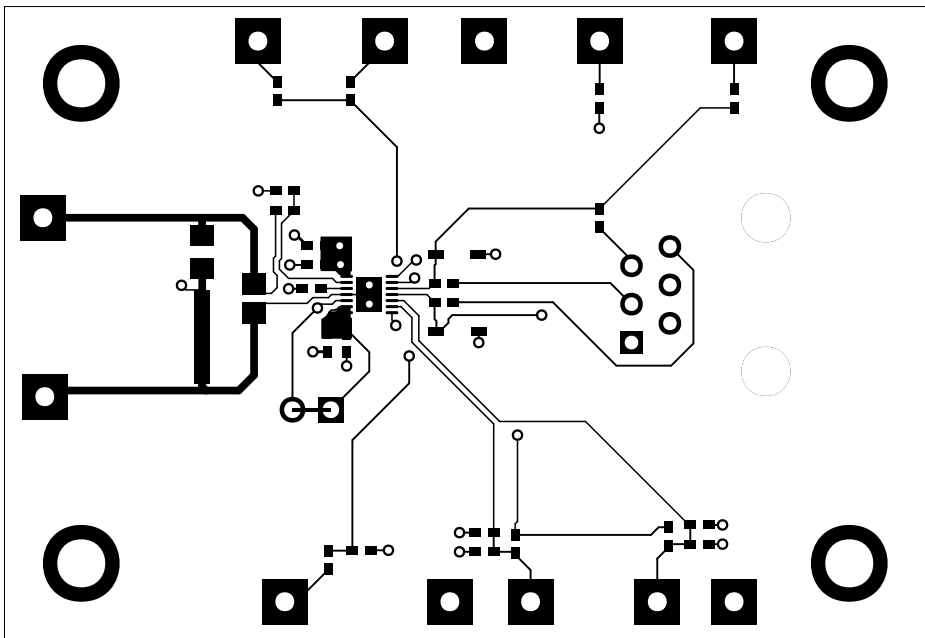

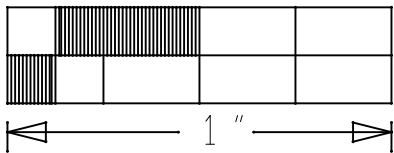
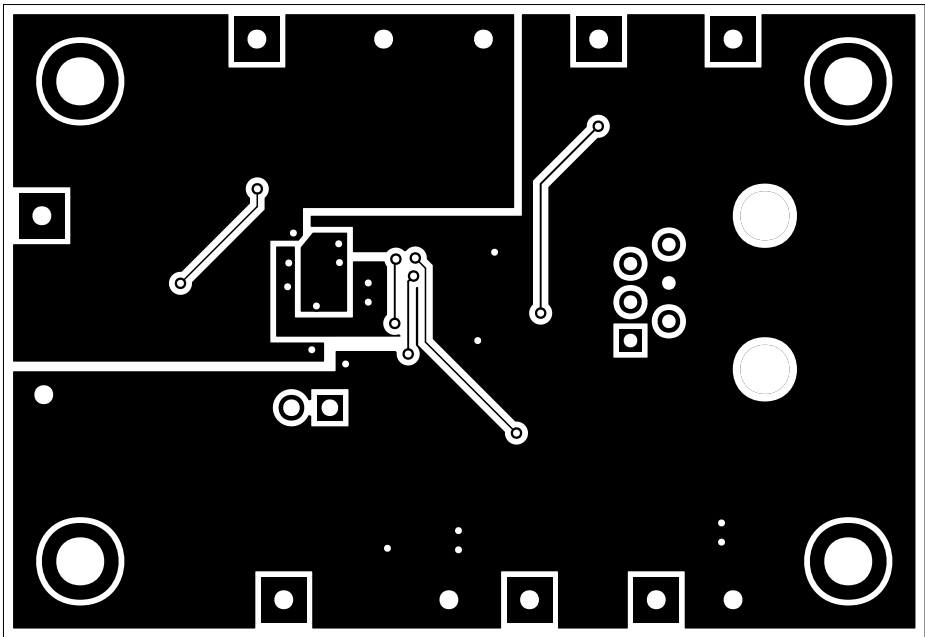

MAX172015 BILL OF MATERIALS REV 0; 2/16

PART	QTY	DESCRIPTION
C1	1	1uF ±20%, 25V X5R ceramic capacitor (0603)
C2	1	0.1uF ±10%, 50V X7R ceramic capacitor (0402)
C3-C6	4	1000pF ±10%, 50V X7R ceramic capacitor (0402)
C7, C8	2	0.47uF ±10%, 25V X5R ceramic capacitor (0402)
C9-C11	3	0.47uF ±10%, 25V X5R ceramic capacitor (0402), not populated
C12, C13	2	0.01uF ±10%, 25V X7R ceramic capacitor (0402)
R1	1	510KΩ ±5%, resistor (0402)
R2, R4	2	1MΩ ±0.1%, resistor (0805)
R3	1	2MΩ ±0.1%, resistor (0805)
R5	1	1.5MΩ ±0.1%, resistor (0805)
R6	1	300KΩ ±0.1%, resistor (0805)
R7	1	200KΩ ±0.1%, resistor (0805)
R8	1	1MΩ ±1%, resistor (0402)
R9	1	10Ω ±5%, resistor (0805)
R10, R11	2	100Ω ±5%, resistor (0805)
R12, R17	2	1KΩ ±1%, resistor (0402)
R13-R15	3	150Ω ±1%, resistor (0402)
R16	1	51.1KΩ ±1%, resistor (0402)
R18, R19	2	10kΩ ±1%, resistor (0402)
R20	1	0.010Ω ±1%, resistor (0805)
R21	1	0Ω resistor (0805), not populated
R23	1	0Ω resistor (0402)
R24	1	0Ω resistor (0402), not populated
RT1, RT2	2	Thermistor 10K NTC (0402) Murata NCP15XH103F03
D1	1	18V Zener Diode (SOD123)
D2, D4	2	5.6V Zener Diode (SOD323)
D3, D5	2	Schottky Diode (SOD323), not populated
Q1, Q2	2	2N7002 FET (SOT-23)
SW1	1	Switch block 4PDT
J1-J12,J14,J16-J21	19	Plated through hole solder pad (16g wire)
J13	1	RJ-11,R/A,6-POSITION/6-CONTACTS
U1	1	Li+ fuel gauge IC 3x3 TDFN 14 pin
	1	PCB: MAX17205EVKIT/MAX17215EVKIT
	1	USB-to-RJ11 board DS91230+
	1	RJ11 6pos-6pos reverse modular cord 6ft.

(10A TRACE)

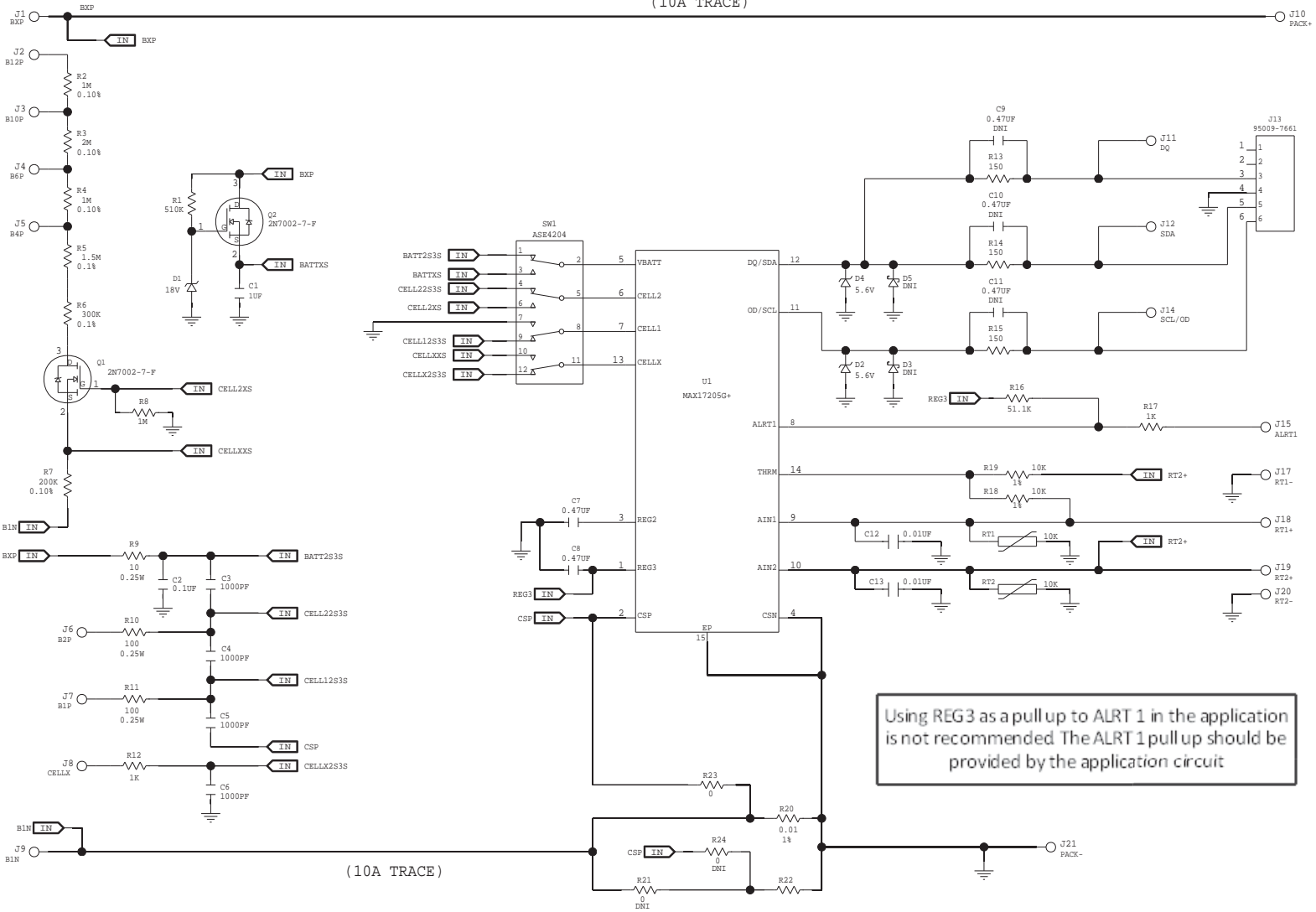

(10A TRACE)

Using REG3 as a pull up to ALRT1 in the application is not recommended. The ALRT1 pull up should be provided by the application circuit

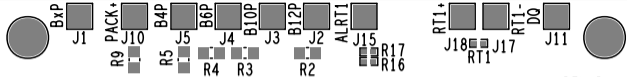

REV-B
01/16 RBJ

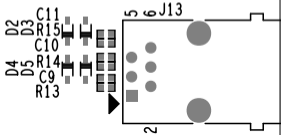
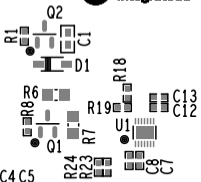
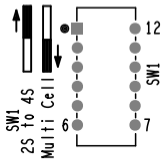

MAX17205G EVKIT
 1-888-629-4642
www.maximintegrated.com

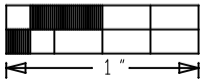
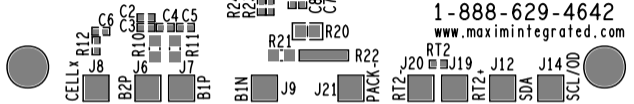

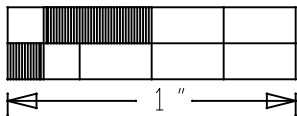
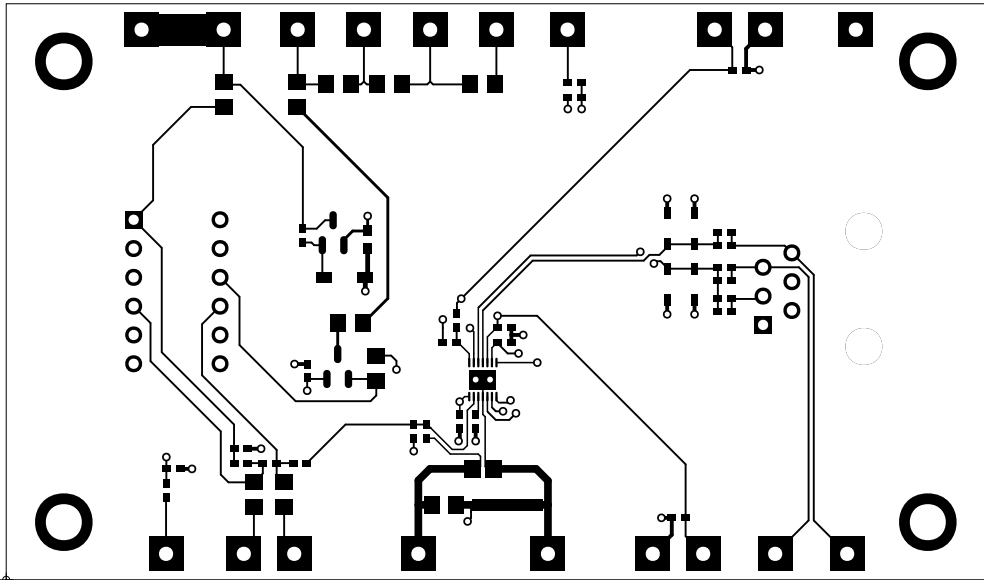



Компания «ЭлектроПласт» предлагает заключение долгосрочных отношений при поставках импортных электронных компонентов на взаимовыгодных условиях!

Наши преимущества:

- Оперативные поставки широкого спектра электронных компонентов отечественного и импортного производства напрямую от производителей и с крупнейших мировых складов;
- Поставка более 17-ти миллионов наименований электронных компонентов;
- Поставка сложных, дефицитных, либо снятых с производства позиций;
- Оперативные сроки поставки под заказ (от 5 рабочих дней);
- Экспресс доставка в любую точку России;
- Техническая поддержка проекта, помощь в подборе аналогов, поставка прототипов;
- Система менеджмента качества сертифицирована по Международному стандарту ISO 9001;
- Лицензия ФСБ на осуществление работ с использованием сведений, составляющих государственную тайну;
- Поставка специализированных компонентов (Xilinx, Altera, Analog Devices, Intersil, Interpoint, Microsemi, Aeroflex, Peregrine, Syfer, Eurofarad, Texas Instrument, Miteq, Cobham, E2V, MA-COM, Hittite, Mini-Circuits, General Dynamics и др.);

Помимо этого, одним из направлений компании «ЭлектроПласт» является направление «Источники питания». Мы предлагаем Вам помощь Конструкторского отдела:

- Подбор оптимального решения, техническое обоснование при выборе компонента;
- Подбор аналогов;
- Консультации по применению компонента;
- Поставка образцов и прототипов;
- Техническая поддержка проекта;
- Защита от снятия компонента с производства.



Как с нами связаться

Телефон: 8 (812) 309 58 32 (многоканальный)

Факс: 8 (812) 320-02-42

Электронная почта: org@eplast1.ru

Адрес: 198099, г. Санкт-Петербург, ул. Калинина, дом 2, корпус 4, литера А.