

# E3JM/E3JK



## Two Models Contribute to Overall Cost Reduction

### E3JM Terminal Block Models

- Easy to wire and adjust.

### E3JK Pre-wired Models

- Slim body is economically priced and full of functions.



Be sure to read *Safety Precautions* on page 10.

For the most recent information on models that have been certified for safety standards, refer to your OMRON website.

## Ordering Information

**Sensors** (Refer to *Dimensions* on page 12.)

### E3JM

Red light Infrared light

Sensing method	Appearance	Connection method	Sensing distance	Operation mode	Output configuration	Functions	Model
Through-beam (Emitter + Receiver) *		Terminal block		Light-ON Dark-ON (switch selectable)	Relay	---	<b>E3JM-10M4-N</b> Emitter: E3JM-10L-N Receiver: E3JM-10DM4-N
							<b>E3JM-10M4T-N</b> Emitter: E3JM-10L-N Receiver: E3JM-10DM4T-N
Retro-reflective with MSR function	 E39-R1 (provided)	Terminal block		Light-ON Dark-ON (switch selectable)	DC SSR	---	<b>E3JM-10S4-N</b> Emitter: E3JM-10L-N Receiver: E3JM-10DS4-N
							<b>E3JM-10S4T-N</b> Emitter: E3JM-10L-N Receiver: E3JM-10DS4T-N
Diffuse-reflective		Terminal block		Light-ON Dark-ON (switch selectable)	Relay	---	<b>E3JM-R4M4</b>
							<b>E3JM-R4M4T</b>
					DC SSR	---	<b>E3JM-R4S4</b>
							<b>E3JM-R4S4T</b>
Diffuse-reflective		Terminal block		Light-ON Dark-ON (switch selectable)	Relay	---	<b>E3JM-DS70M4</b>
							<b>E3JM-DS70M4T</b>
Diffuse-reflective		Terminal block		Light-ON Dark-ON (switch selectable)	DC SSR	---	<b>E3JM-DS70S4</b>
							<b>E3JM-DS70S4T</b>

\* Through-beam Sensors are sold in sets that include both the Emitter and Receiver.

## E3JK

Sensing method	Appearance	Connection method	Sensing distance	Operation mode	Output configuration	Model	
Through-beam (Emitter + Receiver) *1		Pre-wired (2 m)		Light-ON	Relay	E3JK-5M1-N 2M	
				Dark-ON		E3JK-5M2-N 2M	
Retro-reflec- tive with MSR function				Light-ON	Relay	E3JK-R2M1 2M	
				Dark-ON		E3JK-R2M2 2M	
Retro-reflec- tive without MSR function	E39-R1 (provided)			Light-ON	Relay	E3JK-R4M1 2M	
				Dark-ON		E3JK-R4M2 2M	
Diffuse- reflective				Light-ON	Relay	E3JK-DS30M1 2M	
				Dark-ON		E3JK-DS30M2 2M	
				Light-ON	Both selectable	DC SSR	E3JK-5S3-N 2M
				Dark-ON			E3JK-R2S3 2M
			Light-ON	Both selectable	DC SSR	E3JK-R4S3 2M	
			Dark-ON			E3JK-DS30S3 2M	

Note: UL-listed models have the -US suffix. The model number for an E3JM Through-beam Sensor ends in "-US" (and not in "-N"). (Example: E3JM-10M4-US). The model number for an E3JK Through-beam Sensor has "-US" after "-N". (Example: E3JK-5M1-N-US 2M). Tightening nuts, washers, and rubber bushings are not provided with these models.

Change: Shape of the E3JM conduit socket

Note, however, that DC-type E3JK SSR Output Models are not UL-listed.

\*1. Through-beam Sensors are sold in sets that include both the Emitter and Receiver.

\*2. Values in parentheses indicate the sensing distance when using E39-R2 Reflectors.

## Accessories (Order Separately)

**Slit** (A Slit is not provided with the Sensor for through-beam. Order a Slit separately if required.) (Refer to *Dimensions* on page 12.)

Slit width	Sensing distance	Minimum detect- able object (reference value)	Model	Quantity	Remarks
1 mm × 20 mm	E3JM-10□4(T)-N	1.2 m	E39-S39	1 Slit each for the Emitter and Receiver (2 Slits total)	(Seal-type long slit) Can be used with the E3JM-10□4(T)-N and E3JK-5□□-N Through-beam Models.
	E3JK-5□□-N	0.7 m			

## Reflectors (A Reflector is required for Retroreflective Sensors.)



A Reflector is provided with the E39-R1 Sensor. For other Sensors, order a Reflector separately if required. (Refer to *Dimensions* on E39-L/E39-S/E39-R.)

Name	Sensing distance	Model	Quantity	Remarks	
Reflectors	E3JM-R4□4(T)	4 m	E39-R1	1	Provided with the E3JM-R4□4(T) Provided with the E3JK-R2□□ Provided with the E3JK-R4□□
	E3JK-R2□□	2.5 m			
	E3JK-R4□□	4 m			

Note: Refer to *Reflectors* on E39-L/F39-L/E39-S/E39-R for details.

### Mounting Bracket

Some Mounting Brackets are provided with the Sensor. Order other Mounting Brackets separately if required. (Refer to E39-L/E39-S/E39-R)

Appearance	Model	Quantity	Remarks
	<b>E39-L53</b>	1	Provided with the E3JM.
	<b>E39-L40</b>	1	Provided with the E3JK.
	<b>E39-L51</b>	1	Mounting Bracket designed for changing from the E3A-M, E3A2, E3A3, OA-5, or OA-5N to the E3JM.

Note: 1. When using a Through-beam Sensor, order one Connector for the Receiver and one for the Emitter.  
2. Refer to *Mounting Brackets* on E39-L/E39-S/E39-R for details.

## Ratings and Specifications

## E3JM

Sensing method		Through-beam model	Retro-reflective model (with MSR function)	Diffuse-reflective model
Item	Model	E3JM-10□4(T)-N	E3JM-R4□4(T)	E3JM-DS70□4(T)
Sensing distance		10 m	4 m (When using E39-R1)	White paper (200 × 200 mm): 700 mm
Standard sensing object		Opaque: 14.8-mm dia. min.	Opaque: 75-mm dia. min.	---
Differential travel		---		20% max. of sensing distance
Directional angle		Both Emitter and Receiver 3° to 20°	1° to 5°	---
Light source (wavelength)		Infrared LED (950 nm)	Red LED (660 nm)	Infrared LED (950 nm)
Power supply voltage		12 to 240 VDC±10%, ripple (p-p): 10% max. 24 to 240 VAC±10%, 50/60 Hz		
Power consumption	DC	3 W max. (Emitter 1.5 W max. Receiver 1.5 W max.)	2 W max.	
	AC	3 W max. (Emitter 1.5 W max. Receiver 1.5 W max.)	2 W max.	
Control output		Relay output (E3JM-□□M4 (T) model): SPDT, 250 VAC, 3A (cosφ=1) max., 5 VDC, 10 mA min. DC SSR output (E3JM-□□S4 (T) model): 48 VDC, 100 mA max. (residual voltage: 2 V max.) Light-ON/Dark-ON selectable		
Life expectancy (relay output)	Mechanical	50,000,000 times min. (switching frequency: 18,000 times/h)		
	Electrical	100,000 times min. (switching frequency: 1,800 times/h)		
Response time	Relay output	(E3JM-□□M4 (T) models) Operate or reset: 30 ms max.		
	DC SSR output	(E3JM-□□S4 (T) models) Operate or reset: 5 ms max.		
Sensitivity adjustment		---		One-turn adjuster
Timer function *		ON-delay/OFF-delay/One-shot delay switch selectable Delay time: 0.1 to 5 s (adjustable), only for E3JM-□□□4T		
Ambient illumination (Receiver side)		Incandescent lamp: 3,000 lx max.		
Ambient temperature range		Operating: -25°C to 55°C, Storage: -30°C to 70°C (with no icing or condensation)		
Ambient humidity range		Operating: 45% to 85% (with no condensation), Storage: 35% to 95% (with no condensation)		
Insulation resistance		20 MΩ min. at 500 VDC		
Dielectric strength		2,000 VAC, 50/60 Hz for 1 min.		
Vibration resistance	Destruction	10 to 55 Hz, 1.5-mm double amplitude for 2 hours each in X, Y, and Z directions		
	Malfunction	10 to 55 Hz, 1.5-mm double amplitude for 2 hours each in X, Y, and Z directions		
Shock resistance	Destruction	500 m/s <sup>2</sup> 3 times each in X, Y, and Z directions		
	Malfunction	100 m/s <sup>2</sup> 3 times each in X, Y, and Z directions		
Degree of protection		IEC 60529: IP66		
Connection method		Terminal block		
Weight (packed state)		Approx. 270 g	Approx. 160 g	
Material	Case	ABS (Acrylonitril Butadiene Styrene)		
	Lens	Methacrylic resin		
	Cover	Polycarbonate		
	Mounting Bracket	Iron		
Accessories		Mounting Bracket (with screw), Nuts, Terminal Protection Cover, One set of cable connection nuts (excluding -US Models), Instruction manual, Reflector (E39-R1: only for Retro-reflective Sensors)		

\* The timer cannot be disabled for models with timer functions (E3JM-□□□4T).

## E3JK

Sensing method		Through-beam model		Retro-reflective model (with MSR function)		Retro-reflective model (without MSR function)		Diffuse-reflective model	
Item	Model	E3JK -5M□-N	E3JK -5S3-N	E3JK -R2M□	E3JK -R2S3	E3JK -R4M□	E3JK -R4S3	E3JK -DS30M□	E3JK -DS30S3
Sensing distance		5 m		2.5 m (When using E39-R1)		4 m (When using E39-R1)		White paper (100 × 100 mm): 300 mm	
Standard sensing object		Opaque: 14.8-mm dia. min.		Opaque: 75-mm dia. min.				---	
Differential travel				---				20% max. of sensing distance	
Directional angle		Both Emitter and Receiver 3° to 20°		1° to 5°				---	
Light source (wavelength)		Infrared LED (950 nm)		Red LED (660 nm)				Infrared LED (950 nm)	
Power supply voltage		12 to 240 VDC±10%, ripple (p-p): 10% max. 24 to 240 VAC±10%, 50/60 Hz							
Power consumption	DC	3 W max. (Emitter 1.5 W max. Receiver 1.5 W max.)		2 W max.					
	AC	3 W max. (Emitter 1.5 W max. Receiver 1.5 W max.)		2 W max.					
Control output		Relay output SPDT, 250 VAC, 3 A max. (cosφ= 1) 5 VDC, 10 mA min.	DC SSR output, Negative: common 48 VDC, 100 mA max. Leakage current: 0.1 mA max. With load short-circuit protection	Relay output SPDT, 250 VAC, 3 A max. (cosφ= 1) 5 VDC, 10 mA min.	DC SSR output, Negative: common 48 VDC, 100 mA max. Leakage current: 0.1 mA max. With load short-circuit protection	Relay output SPDT, 250 VAC, 3 A max. (cosφ= 1) 5 VDC, 10 mA min.	DC SSR output, Negative: common 48 VDC, 100 mA max. Leakage current: 0.1 mA max. With load short-circuit protection	Relay output SPDT, 250 VAC, 3 A max. (cosφ= 1) 5 VDC, 10 mA min.	DC SSR output, Negative: common 48 VDC, 100 mA max. Leakage current: 0.1 mA max. With load short-circuit protection
Life expectancy (relay output)	Mechanical	50,000,000 times min. (switching frequency: 18,000 times/h)							
	Electrical	100,000 times min. (switching frequency: 1,800 times/h)							
Response time		30 ms max.	10 ms max.	30 ms max.	5 ms max.	30 ms max.	5 ms max.	30 ms max.	5 ms max.
Sensitivity adjustment		---						One-turn adjuster	
Ambient illumination (Receiver side)		Incandescent lamp: 3,000 lx max.							
Ambient temperature range		Operating: -25°C to 55°C, Storage: -30°C to 70°C (with no icing or condensation)							
Ambient humidity range		Operating: 45% to 85% (with no condensation), Storage: 35% to 95% (with no condensation)							
Insulation resistance		20 MΩ min. at 500 VDC							
Dielectric strength		1,500 VAC, 50/60 Hz for 1 min.							
Vibration resistance	Destruction	10 to 55 Hz, 1.5-mm double amplitude for 2 hours each in X, Y, and Z directions							
	Malfun-ction	10 to 55 Hz, 1.5-mm double amplitude for 2 hours each in X, Y, and Z directions							
Shock resistance	Destruction	500 m/s <sup>2</sup> 3 times each in X, Y, and Z directions							
	Malfun-ction	100 m/s <sup>2</sup> 3 times each in X, Y, and Z directions	500 m/s <sup>2</sup> 3 times each in X, Y, and Z directions	100 m/s <sup>2</sup> 3 times each in X, Y, and Z directions	500 m/s <sup>2</sup> 3 times each in X, Y, and Z directions	100 m/s <sup>2</sup> 3 times each in X, Y, and Z directions	500 m/s <sup>2</sup> 3 times each in X, Y, and Z directions	100 m/s <sup>2</sup> 3 times each in X, Y, and Z directions	500 m/s <sup>2</sup> 3 times each in X, Y, and Z directions
Degree of protection		IEC 60529 IP64							
Connection method		Pre-wired (standard length: 2 m)							
Weight (packed state)		Approx. 420 g		Approx. 250 g					
Material	Case	ABS (Acrylonitril Butadiene Styrene)							
	Lens	Methacrylic resin							
	Mounting Bracket	Iron							
Accessories		Mounting Bracket (with screws), Nuts, Instruction manual, Reflector (Retro-reflective Models only)							

Engineering Data (Reference Value)

Parallel Operating Range

Through-beam

E3JM-10□4(T)-N

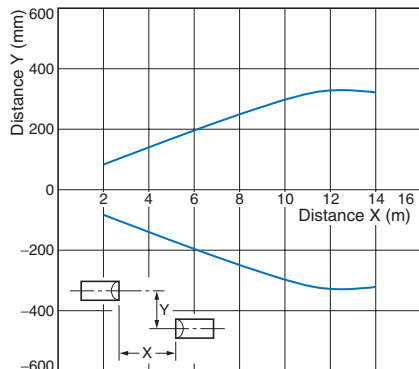

Through-beam

E3JM-10□4(T)-N + E39-S39 (Optional Slit)  
(A Slit is mounted to the Emitter and Receiver.)

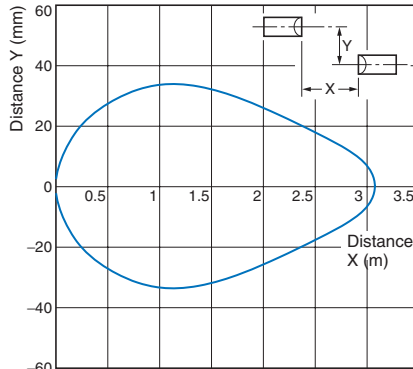

Retro-reflective

E3JM-R4□4(T) + E39-R1  
(Supplied Reflector)

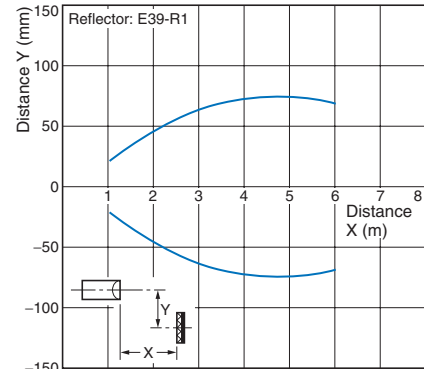

Operating Range

Diffuse-reflective

E3JM-DS70□4(T)

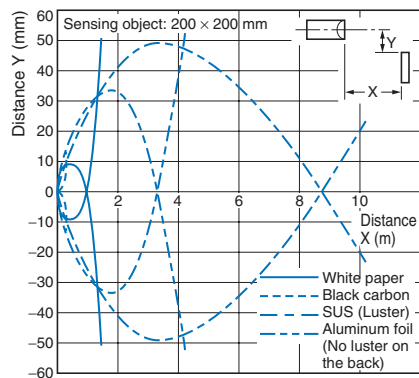

Excess Gain Ratio vs. Set Distance

Through-beam

E3JM-10□4(T)-N

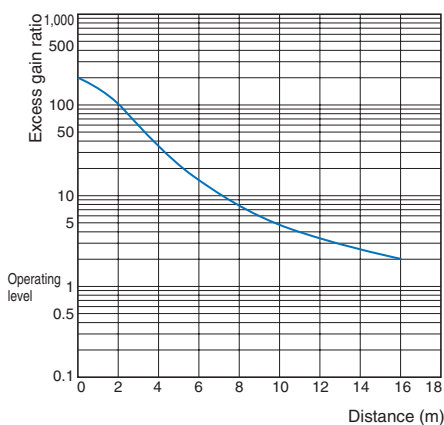

Retro-reflective

E3JM-R4□4(T) + E39-R1  
(Supplied Reflector)

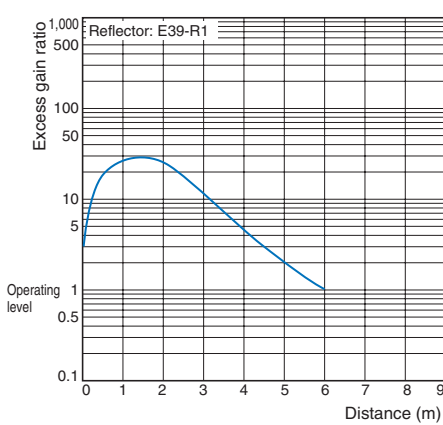

E3JM-R4□4(T) + E39-R3  
(Optional Reflector)

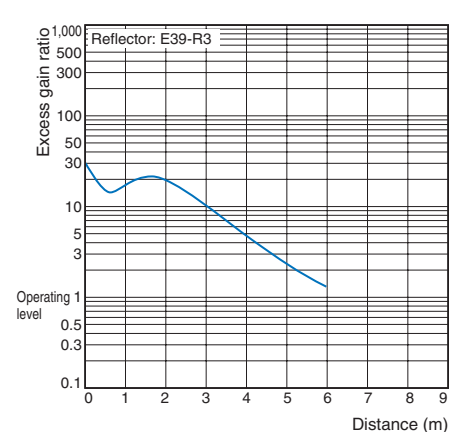

**Diffuse-reflective**

**E3JM-DS70□4(T)**

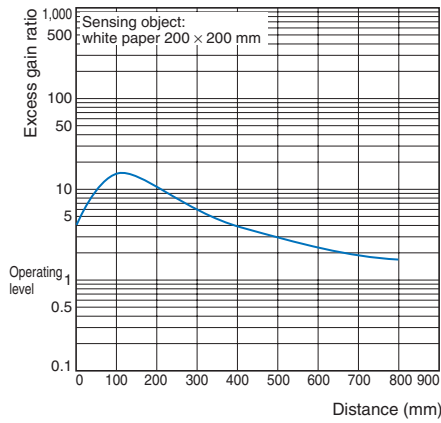

**Sensing Object Size vs. Sensing Distance**

**E3JM-DS70□4(T)**

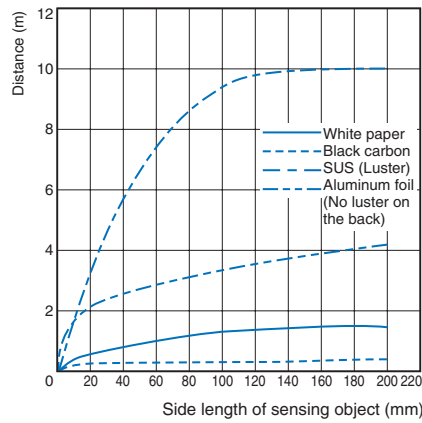

**Parallel Operating Range**

**Through-beam**

**E3JK-5□□-N**

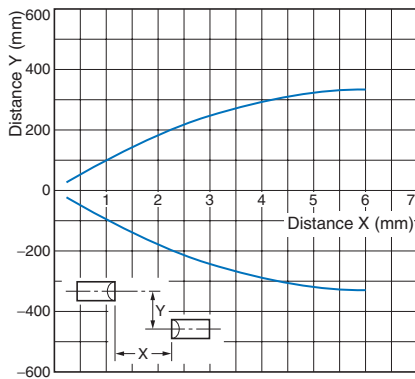

**E3JK-5□□-N + E39-S39 (Optional Slit)**

(A Slit is mounted to the Emitter and Receiver.)

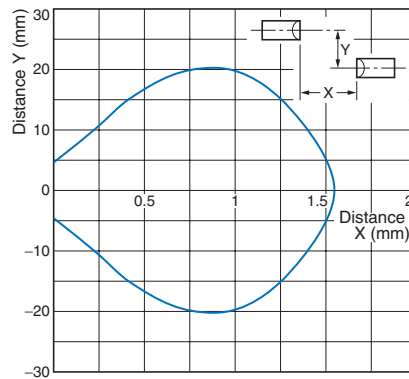

**Retro-reflective**

**E3JK-R2□□ + E39-R1**

(Supplied Reflector)

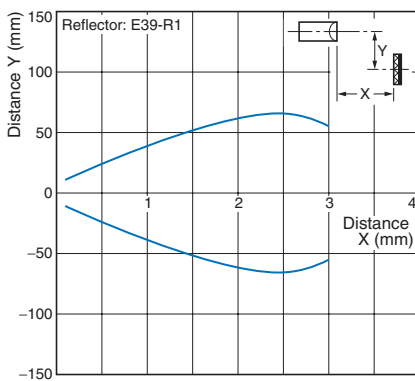

**E3JK-R4□□ + E39-R1**

(Supplied Reflector)

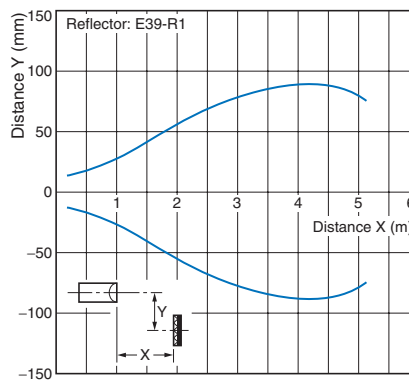

**Operating Range**

**Diffuse-reflective**

E3JK-DS30□□

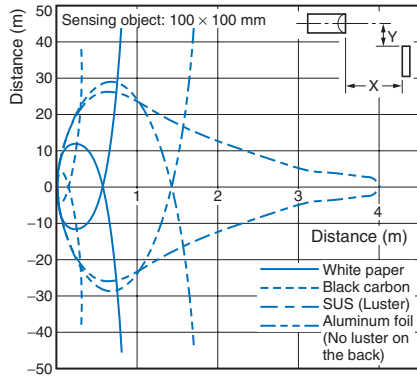

**Sensing Object Size vs. Sensing Distance**

**Diffuse-reflective**

E3JK-DS30□□

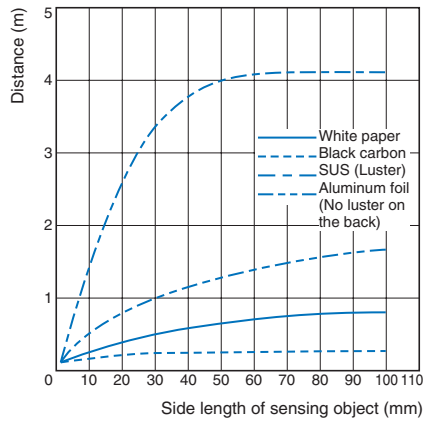

**Excess Gain Ratio vs. Set Distance**

**Through-beam**

E3JK-5□□-N

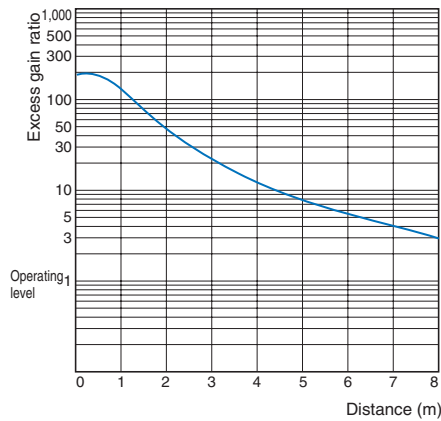

**Retro-reflective**

E3JK-R2□□ + E39-R1 (Supplied Reflector)

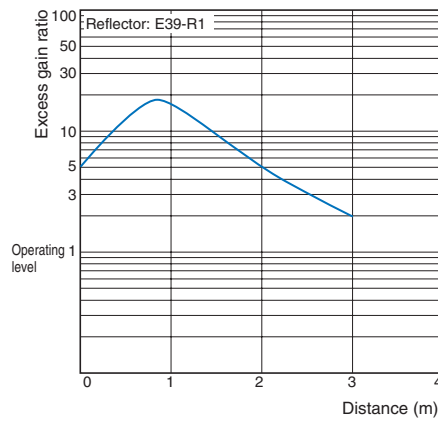

E3JK-R4□□ + E39-R1 (Supplied Reflector)

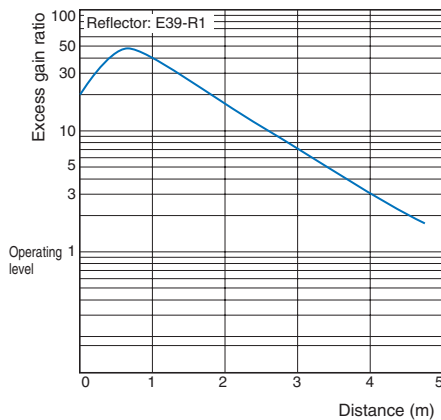

**Diffuse-reflective**

E3JK-DS30□□

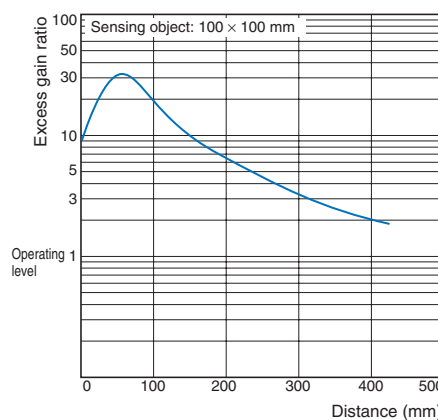



## I/O Circuit Diagrams

### E3JM

#### Relay Output Models

Model	Timing chart	Output circuit
E3JM-10M4(T)-N *1 E3JM-R4M4(T) E3JM-DS70M4(T)	<p>Incident light No incident light Indicator (red) *2 L-ON (Ta) D-ON (Ta)</p> <p>ON OFF ON OFF ON OFF</p> <p>Refer to page 10 for information on Sensors with timers (T).</p>	<p>24 to 240 VAC 12 to 240 VDC Power Source No polarity Tb Tc Ta Contact output (Built-in Relay: G6C)</p>

#### DC SSR Output Models

Model	Timing chart	Output circuit
E3JM-10S4(T)-N *1 E3JM-R4S4(T) E3JM-DS70S4(T)	<p>Incident light No incident light Indicator (red) *2 L-ON (Ta) D-ON (Ta)</p> <p>ON OFF ON OFF ON OFF</p> <p>Refer to page 10 for information on Sensors with timers (T).</p>	<p>24 to 240 VAC 12 to 240 VDC Power Source No polarity L/ON NO I1 D/ON NC I2 COM 48 VDC max. <math>I_1 + I_2 &lt; 100 \text{ mA}</math></p>

Note: Connect terminal 1 to any polarity and terminal 2 to the power supply because there is no polarity on the Emitter side.

\*1. Models numbers for Through-beam Sensors (E3JM-10□4(T)-N) are for sets that include both the Emitter and Receiver.

The model number of the Emitter is always E3JM-10L-N. Add a "D" to get the model number of the Receiver (example: E3JM-10DM4-N). Confirm the model numbers of the Emitter and Receiver in *Ordering Information*.

\*2. This is the light indicator on Sensors without a timer and the operation indicator on Sensors with a timer.

### E3JK

#### Relay Output Models

Model	Timing chart	Output circuit
E3JK-5M1-N * E3JK-5M2-N *	<p>Incident light No incident light Light indicator (red) L-ON (Ta) D-ON (Ta)</p> <p>ON OFF ON OFF ON OFF</p>	<p>24 to 240 VAC 12 to 240 VDC Power Source No polarity Brown Blue White Black Gray Tc Tb Ta Contact output (Built-in Relay: G6C)</p>

#### DC SSR Output Models

Model	Timing chart	Output circuit
E3JK-5S3-N * E3JK-R2S3 E3JK-R4S3 E3JK-DS30S3	<p>Incident light No incident light Light indicator (red) L-ON output D-ON output</p> <p>ON OFF ON OFF ON OFF</p>	<p>24 to 240 VAC 12 to 240 VDC Power Source No polarity Brown Blue White Black Gray D/ON L/ON I1 I2 48 VDC max. <math>I_1 + I_2 &lt; 100 \text{ mA}</math></p> <p>Note: The output stage leakage currents are 0.1 mA max., respectively.</p>

Note: Connect the brown cable to any polarity and the blue cable to the power supply because there is no polarity on the Emitter side.

\* Models numbers for Through-beam Sensors (E3JK-5□□-N 2M) are for sets that include both the Emitter and Receiver.

The model number of the Emitter is always E3JK-5L-N 2M. Add a "D" to get the model number of the Receiver (example: E3JK-5DM1-N 2M). Confirm the model numbers of the Emitter and Receiver in *Ordering Information*.

## Safety Precautions

Refer to *Warranty and Limitations of Liability*.

**⚠ WARNING**

This product is not designed or rated for ensuring safety of persons either directly or indirectly. Do not use it for such purposes.



**Precautions for Correct Use**

Do not use the product in atmospheres or environments that exceed product ratings.

**E3JM**

● **Designing**

**Operation**

Note: The white part of the DIP switch indicates which setting is selected.

	Switch configuration	Switch selection	Timing charts												
<b>Models without timer</b>	<p>MODE 0 ↔ 1</p> <p>D-ON  L-ON</p> <p>↑</p> <p>Operation selector</p>	<p>MODE 0 ↔ 1</p> <p>D-ON  L-ON ← Light-ON, Relay ON, DC output switching element ON</p> <p>MODE 0 ↔ 1</p> <p>D-ON  L-ON ← Dark-ON, Relay ON, DC output switching element ON</p>													
<b>Models with timer</b>	<p>MODE 0 ↔ 1</p> <p>D-ON  L-ON</p> <p>SW1 </p> <p>SW2 </p> <p>Operation Selector</p> <p>Selector switch for timer mode</p>	<table border="1"> <thead> <tr> <th>ON-delay</th> <th>OFF-delay</th> <th>One-shot delay</th> </tr> </thead> <tbody> <tr> <td> <p>MODE 0 ↔ 1</p> <p>D-ON  L-ON</p> <p>SW1 </p> <p>SW2 </p> <p>TIMER</p> <p>Both SW1 and SW2 at "0."</p> </td> <td> <p>MODE 0 ↔ 1</p> <p>D-ON  L-ON</p> <p>SW1 </p> <p>SW2 </p> <p>TIMER</p> <p>Only SW2 at "1."</p> </td> <td> <p>MODE 0 ↔ 1</p> <p>D-ON  L-ON</p> <p>SW1 </p> <p>SW2 </p> <p>TIMER</p> <p>Only SW1 at "1," which overrides either setting of SW2.</p> </td> </tr> </tbody> </table> <p>Note: The operation selector is the same as that for models without a timer.</p>	ON-delay	OFF-delay	One-shot delay	<p>MODE 0 ↔ 1</p> <p>D-ON  L-ON</p> <p>SW1 </p> <p>SW2 </p> <p>TIMER</p> <p>Both SW1 and SW2 at "0."</p>	<p>MODE 0 ↔ 1</p> <p>D-ON  L-ON</p> <p>SW1 </p> <p>SW2 </p> <p>TIMER</p> <p>Only SW2 at "1."</p>	<p>MODE 0 ↔ 1</p> <p>D-ON  L-ON</p> <p>SW1 </p> <p>SW2 </p> <p>TIMER</p> <p>Only SW1 at "1," which overrides either setting of SW2.</p>	<table border="1"> <thead> <tr> <th>ON-delay</th> <th>OFF-delay</th> <th>One-shot delay</th> </tr> </thead> <tbody> <tr> <td> </td> <td> </td> <td> </td> </tr> </tbody> </table>	ON-delay	OFF-delay	One-shot delay			
ON-delay	OFF-delay	One-shot delay													
<p>MODE 0 ↔ 1</p> <p>D-ON  L-ON</p> <p>SW1 </p> <p>SW2 </p> <p>TIMER</p> <p>Both SW1 and SW2 at "0."</p>	<p>MODE 0 ↔ 1</p> <p>D-ON  L-ON</p> <p>SW1 </p> <p>SW2 </p> <p>TIMER</p> <p>Only SW2 at "1."</p>	<p>MODE 0 ↔ 1</p> <p>D-ON  L-ON</p> <p>SW1 </p> <p>SW2 </p> <p>TIMER</p> <p>Only SW1 at "1," which overrides either setting of SW2.</p>													
ON-delay	OFF-delay	One-shot delay													

**Output Relay Contact**

If E3JM/E3JK is connected to a load with contacts that spark when the load is turned OFF (e.g., a contactor or valve), the normally-closed side may be turned ON before the normally-open side is turned OFF or vice-versa. If both normally-open output and normally-closed output are used simultaneously, apply a surge suppressor to the load.

Refer to *OMRON's PCB Relays Catalog (X33)* for typical examples of surge suppressors.

## ● Wiring

### Connecting and Wiring

- We recommend connecting a cable with a conductor cross-section of 0.3 mm<sup>2</sup> and an outer diameter of 6 to 8 mm.
- Be sure to firmly tighten the cover in order to maintain waterproof and dustproof properties. The screw size of the conduit sockets is shown in the following table.

Model	Conduit socket thread size
E3JM-□	PF1/2

### Cable End Treatment

Adjust the four wires to the same length when the Ta output is to be used only. If both the Ta and Tb outputs are to be used, treat them as shown in the following diagram.

#### Recommended example

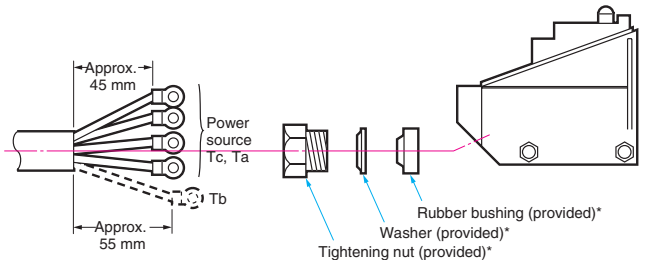

\* These parts are not provided with models with a -US suffix.

### Recommended Crimp Terminal Dimensions (Unit: mm)

Round type	Fork type
<p>(After crimping)</p>	<p>(After crimping)</p>

Note: Use terminals with insulation tube (recommended crimp terminal: 1.25 to 3.5).

## ● Others

### Terminal Protection Cover (Provided)

The terminal protection cover is designed to improve safety by maintaining the sensitivity properties of the product and by preventing any contact with charged sections while it is being operated with the mode set to the timer mode. Mount the product as shown in the following diagram (mount the Through-beam Model on the Receiver side).

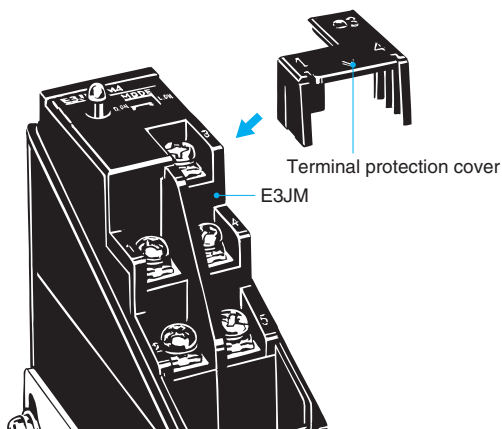

## E3JK

## ● Designing

### Power Reset Time

The Sensor is ready to detect within 200 ms after it is turned ON. If the Sensor and load are connected to separate power supplies, be sure to turn ON the Sensor first.

## Items Common to E3JM and E3JK

## ● Wiring

### Connecting and Wiring DC SSR Output Models

When using the DC SSR output model, the total of the load current for the Light-ON output (NO) and that for the Dark-ON (NC) should be 100 mA max. If the total exceeds 100 mA, the load short-circuit protection function will be activated (this function will be reset when the power of the Photoelectric Sensor is turned OFF).

## ● Others

### Ambient Conditions (Installation Area)

The E3JM will malfunction if installed in the following places.

- Places where the E3JM is exposed to a dusty environment.
- Places where corrosive gases are produced.

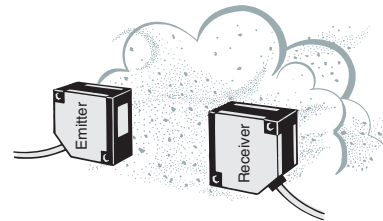

- Places where the E3JM is directly exposed to water, oil, or chemicals.

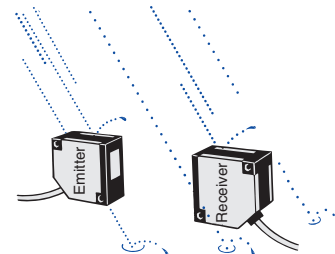

## Dimensions

### Sensors

#### E3JM-10□4(T)-N \*1

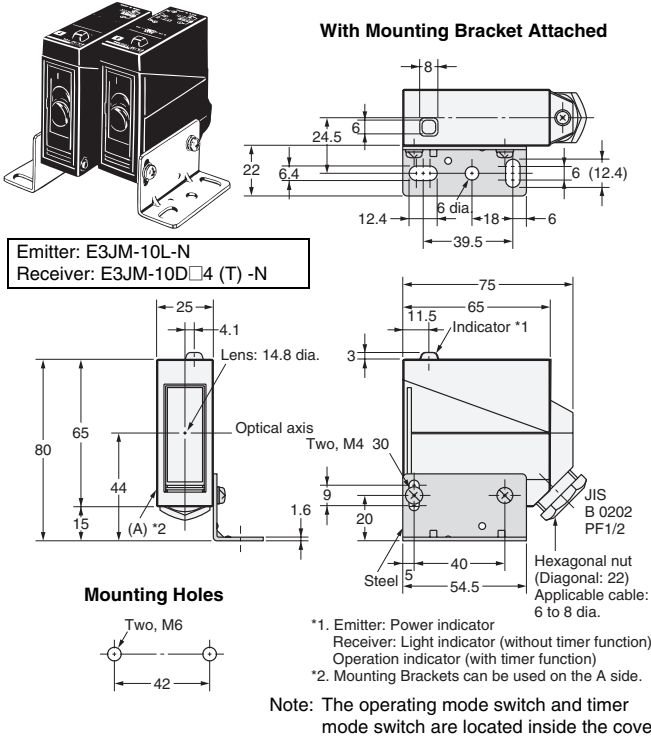

#### E3JM-R4□4(T) E3JM-DS70□4(T)

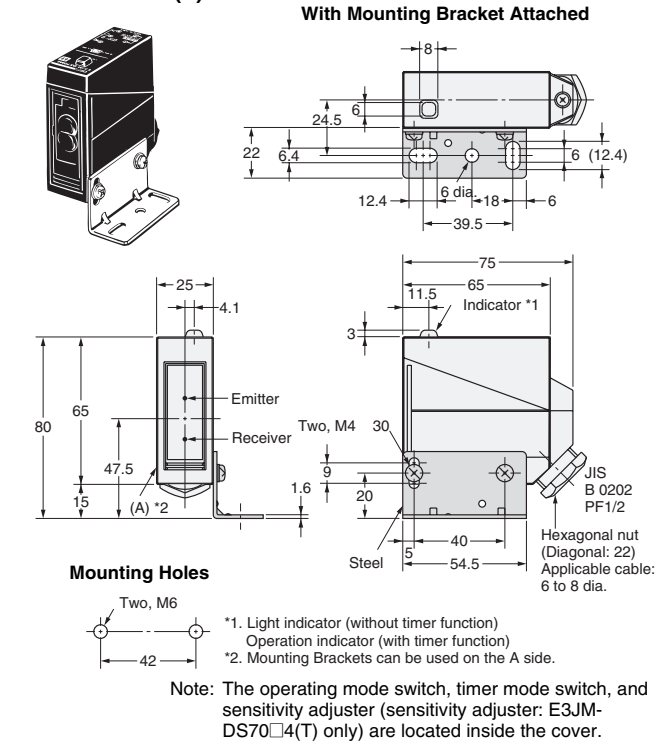

#### E3JK-5□□-N \*2

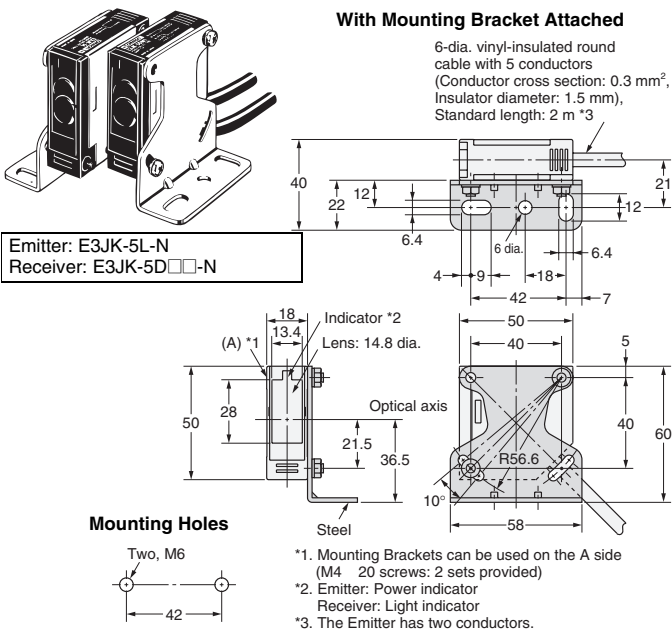

#### E3JK-R2□□ E3JK-R4□□ E3JK-DS30□□

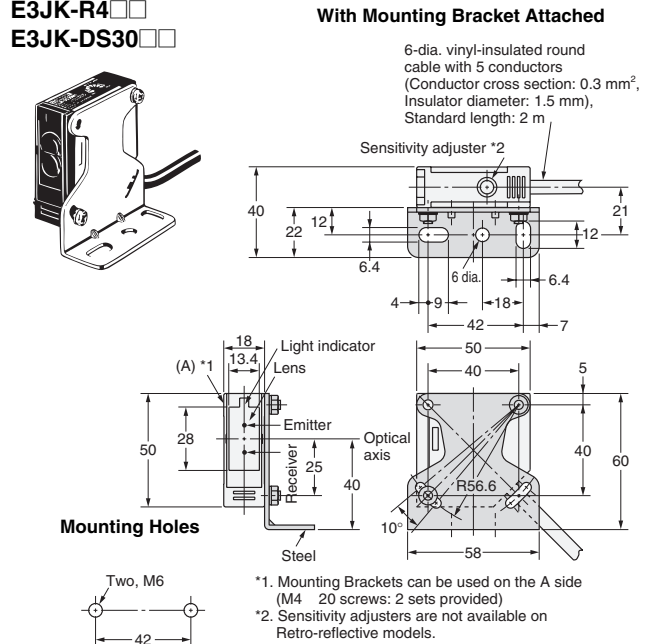

\*1. Models numbers for Through-beam Sensors (E3JM-10□4(T)-N) are for sets that include both the Emitter and Receiver.

The model number of the Emitter is always E3JM-10L-N. Add a "D" to get the model number of the Receiver (example: EE3JM-10DM4-N). Confirm the model numbers of the Emitter and Receiver in *Ordering Information*.

\*2. Models numbers for Through-beam Sensors (E3JK-5□□-N) are for sets that include both the Emitter and Receiver.

The model number of the Emitter is always E3JK-5L-N 2M. Add a "D" to get the model number of the Receiver (example: E3JK-5DM1-N 2M). Confirm the model numbers of the Emitter and Receiver in *Ordering Information*.

## Accessories (Order separately)

### Seal-type Long Slit (For E3JM/E3JK)

#### E39-S39



Materials: Polyester  
0.1-mm thick

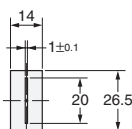

### Mounting Brackets

Refer to E39-L/E39-S/E39-R for details.

## Read and Understand This Catalog

Please read and understand this catalog before purchasing the products. Please consult your OMRON representative if you have any questions or comments.

## Warranty and Limitations of Liability

### WARRANTY

OMRON's exclusive warranty is that the products are free from defects in materials and workmanship for a period of one year (or other period if specified) from date of sale by OMRON.

OMRON MAKES NO WARRANTY OR REPRESENTATION, EXPRESS OR IMPLIED, REGARDING NON-INFRINGEMENT, MERCHANTABILITY, OR FITNESS FOR PARTICULAR PURPOSE OF THE PRODUCTS. ANY BUYER OR USER ACKNOWLEDGES THAT THE BUYER OR USER ALONE HAS DETERMINED THAT THE PRODUCTS WILL SUITABLY MEET THE REQUIREMENTS OF THEIR INTENDED USE. OMRON DISCLAIMS ALL OTHER WARRANTIES, EXPRESS OR IMPLIED.

### LIMITATIONS OF LIABILITY

OMRON SHALL NOT BE RESPONSIBLE FOR SPECIAL, INDIRECT, OR CONSEQUENTIAL DAMAGES, LOSS OF PROFITS OR COMMERCIAL LOSS IN ANY WAY CONNECTED WITH THE PRODUCTS, WHETHER SUCH CLAIM IS BASED ON CONTRACT, WARRANTY, NEGLIGENCE, OR STRICT LIABILITY.

In no event shall the responsibility of OMRON for any act exceed the individual price of the product on which liability is asserted.

IN NO EVENT SHALL OMRON BE RESPONSIBLE FOR WARRANTY, REPAIR, OR OTHER CLAIMS REGARDING THE PRODUCTS UNLESS OMRON'S ANALYSIS CONFIRMS THAT THE PRODUCTS WERE PROPERLY HANDLED, STORED, INSTALLED, AND MAINTAINED AND NOT SUBJECT TO CONTAMINATION, ABUSE, MISUSE, OR INAPPROPRIATE MODIFICATION OR REPAIR.

## Application Considerations

### SUITABILITY FOR USE

OMRON shall not be responsible for conformity with any standards, codes, or regulations that apply to the combination of products in the customer's application or use of the products.

At the customer's request, OMRON will provide applicable third party certification documents identifying ratings and limitations of use that apply to the products. This information by itself is not sufficient for a complete determination of the suitability of the products in combination with the end product, machine, system, or other application or use.

The following are some examples of applications for which particular attention must be given. This is not intended to be an exhaustive list of all possible uses of the products, nor is it intended to imply that the uses listed may be suitable for the products:

- Outdoor use, uses involving potential chemical contamination or electrical interference, or conditions or uses not described in this catalog.
- Nuclear energy control systems, combustion systems, railroad systems, aviation systems, medical equipment, amusement machines, vehicles, safety equipment, and installations subject to separate industry or government regulations.
- Systems, machines, and equipment that could present a risk to life or property.

Please know and observe all prohibitions of use applicable to the products.

NEVER USE THE PRODUCTS FOR AN APPLICATION INVOLVING SERIOUS RISK TO LIFE OR PROPERTY WITHOUT ENSURING THAT THE SYSTEM AS A WHOLE HAS BEEN DESIGNED TO ADDRESS THE RISKS, AND THAT THE OMRON PRODUCTS ARE PROPERLY RATED AND INSTALLED FOR THE INTENDED USE WITHIN THE OVERALL EQUIPMENT OR SYSTEM.

### PROGRAMMABLE PRODUCTS

OMRON shall not be responsible for the user's programming of a programmable product, or any consequence thereof.

## Disclaimers

### CHANGE IN SPECIFICATIONS

Product specifications and accessories may be changed at any time based on improvements and other reasons.

It is our practice to change model numbers when published ratings or features are changed, or when significant construction changes are made. However, some specifications of the products may be changed without any notice. When in doubt, special model numbers may be assigned to fix or establish key specifications for your application on your request. Please consult with your OMRON representative at any time to confirm actual specifications of purchased products.

### DIMENSIONS AND WEIGHTS

Dimensions and weights are nominal and are not to be used for manufacturing purposes, even when tolerances are shown.

### PERFORMANCE DATA

Performance data given in this catalog is provided as a guide for the user in determining suitability and does not constitute a warranty. It may represent the result of OMRON's test conditions, and the users must correlate it to actual application requirements. Actual performance is subject to the OMRON Warranty and Limitations of Liability.

### ERRORS AND OMISSIONS

The information in this document has been carefully checked and is believed to be accurate; however, no responsibility is assumed for clerical, typographical, or proofreading errors, or omissions.

2012.8

In the interest of product improvement, specifications are subject to change without notice.

**OMRON Corporation**  
Industrial Automation Company

<http://www.ia.omron.com/>

(c)Copyright OMRON Corporation 2012 All Right Reserved.

# Mouser Electronics

Authorized Distributor

Click to View Pricing, Inventory, Delivery & Lifecycle Information:

Omron:

[E39-L40](#) [E39-L53](#) [E3JK-DS30S3 2M](#) [E3JK-5S3-N 2M](#) [E3JK-R2S3 2M](#) [E39-L51](#) [E3JM-10M4-N](#) [E3JK-5M1-N-US](#)



Компания «ЭлектроПласт» предлагает заключение долгосрочных отношений при поставках импортных электронных компонентов на взаимовыгодных условиях!

Наши преимущества:

- Оперативные поставки широкого спектра электронных компонентов отечественного и импортного производства напрямую от производителей и с крупнейших мировых складов;
- Поставка более 17-ти миллионов наименований электронных компонентов;
- Поставка сложных, дефицитных, либо снятых с производства позиций;
- Оперативные сроки поставки под заказ (от 5 рабочих дней);
- Экспресс доставка в любую точку России;
- Техническая поддержка проекта, помощь в подборе аналогов, поставка прототипов;
- Система менеджмента качества сертифицирована по Международному стандарту ISO 9001;
- Лицензия ФСБ на осуществление работ с использованием сведений, составляющих государственную тайну;
- Поставка специализированных компонентов (Xilinx, Altera, Analog Devices, Intersil, Interpoint, Microsemi, Aeroflex, Peregrine, Syfer, Eurofarad, Texas Instrument, Miteq, Cobham, E2V, MA-COM, Hittite, Mini-Circuits, General Dynamics и др.);

Помимо этого, одним из направлений компании «ЭлектроПласт» является направление «Источники питания». Мы предлагаем Вам помощь Конструкторского отдела:

- Подбор оптимального решения, техническое обоснование при выборе компонента;
- Подбор аналогов;
- Консультации по применению компонента;
- Поставка образцов и прототипов;
- Техническая поддержка проекта;
- Защита от снятия компонента с производства.



#### Как с нами связаться

**Телефон:** 8 (812) 309 58 32 (многоканальный)

**Факс:** 8 (812) 320-02-42

**Электронная почта:** [org@eplast1.ru](mailto:org@eplast1.ru)

**Адрес:** 198099, г. Санкт-Петербург, ул. Калинина, дом 2, корпус 4, литера А.