

# General Specifications

## B Electrical Capacity (Resistive Load)

**Power Level (silver):** 6A @ 125V AC & 3A @ 250V AC  
4A @ 30V DC for On-None-On; 3A @ 30V DC for all other circuits

**Logic Level (gold):** 0.4VA maximum @ 28V AC/DC maximum  
(Applicable Range 0.1mA ~ 0.1A @ 20mV ~ 28V)

**Logic/Power Level (gold over silver):** Combines silver & gold ratings  
Note: Find additional explanation of dual rating & operating range in Supplement section.

## Other Ratings

**Contact Resistance:** 10 milliohms maximum for silver; 20 milliohms maximum for gold

**Insulation Resistance:** 1,000 megohms minimum @ 500V DC

**Dielectric Strength:** 1,000V AC minimum between contacts for 1 minute minimum;  
1,500V AC minimum between contacts and case for 1 minute minimum

**Mechanical Life:** 50,000 operations minimum

**Electrical Life:** 25,000 operations minimum for silver; 50,000 operations minimum for gold;  
50,000 operations minimum for silver at 3A @ 125V AC

**Angle of Throw:** 25°

## Materials & Finishes

**Actuator Clip & Mounting Frame:** Stainless Steel

**Body Frame:** Stainless steel

**Case:** Diallyl phthalate resin (UL94V-0)

**Movable Contactor:** Phosphor bronze with silver or gold plating

**Movable Contacts:** Silver alloy (code W); copper with gold plating (code G); or silver alloy with gold plating (code A)

**Stationary Contacts:** Silver with silver plating (code W); copper or brass with gold plating (code G);  
or silver with gold plating (code A)

**Terminals:** Copper or brass with silver plating; or copper or brass with gold plating

## Environmental Data

**Operating Temp Range:** -30°C through +85°C (-22°F through +185°F)

**Humidity:** 90 ~ 95% humidity for 96 hours @ 40°C (104°F)

**Vibration:** 10 ~ 55Hz with peak-to-peak amplitude of 1.5mm traversing the frequency range & returning  
in 1 minute; 3 right angled directions for 2 hours

**Shock:** 50G (490m/s<sup>2</sup>) acceleration (tested in 6 right angled directions, with 5 shocks in each direction)

## Processing

**Soldering:** Wave Soldering (PC version) for Gold: See Profile A in Supplement section.

Manual Soldering for Gold: See Profile A in Supplement section.

Wave Soldering (PC version) for Silver: See Profile B in Supplement section.

Manual Soldering for Silver: See Profile B in Supplement section.

Note: Actuator must be in OFF (center) position while soldering.

**Cleaning:** These devices are not process sealed. Hand clean locally using alcohol based solution.

## Standards & Certifications

**Flammability Standards:** UL94V-0 for case

**UL:** File No. E44145 - Recognized only when ordered with marking on switch.

Add "/U" before first dash in part number to order UL recognized switch.

All models recognized at 6A @ 125V AC, 3A @ 250V AC or 0.4VA maximum @ 28V DC maximum.

**CSA:** File No. 023535\_0\_000 - Certified only when ordered with marking on switch.

Add "/C" before first dash in part number to order CSA certified switch.

All models certified at 6A @ 125V AC or 3A @ 250V AC or 0.4VA maximum @ 28V maximum.

# Distinctive Characteristics

Three methods of panel mounting: flat frame for flush with face or subpanel, snap-in, and PCB.

High insulating barriers increase isolation of circuits in multipole devices and provide added protection to contact points.

The molded diallyl phthalate case has a UL 94V-0 flammability rating.

Epoxy sealed terminals prevent entry of solder flux and other contaminants.

Prominent external insulating barriers increase insulation resistance and dielectric strength.

Bias guard prevents misalignment of contacts; interlocking of actuator block with rocker and internal guide does not allow transmission of diagonal force on rocker to reach contact mechanism.

Clinching of the frame to the case well above the base and terminals provides 1,500V dielectric strength.



Actual Size



- Toggle
- B** Rockers
- Pushbuttons
- Illuminated PB
- Programmable
- Keylocks
- Rotaries
- Slides
- Tactiles
- Tilt
- Touch
- Indicators
- Accessories
- Supplement

## TYPICAL SWITCH

## ORDERING EXAMPLE

**M20** — **1** — **3** — **TX** — **G**

Poles	
1	SPDT
2	DPDT SP3T
3	3PDT (used only with terminal codes 30 & 41 & frame code TX)
4	4PDT DP3T (used only with terminal code 41 & frame code TX)

Mounting Frames	
TX	Narrow Frame for Small Actuator
TZ	Wide Frame for Large Actuator

Circuits			
2	ON	NONE	ON
3	ON	OFF	ON
5	ON	NONE	(ON)
8	(ON)	OFF	(ON)
9	ON	OFF	(ON)
*4	ON	ON	ON
*6	(ON)	ON	(ON)
*7	ON	ON	(ON)

( ) = Momentary  
\* 3-ON circuits

Contact Materials & Ratings	
W	Silver; Rated 6A @ 125V AC & 3A @ 250V AC
G	Gold; Rated 0.4VA max @ 28V AC/DC max
A	Gold over Silver; Rated 6A @ 125V AC & 0.4VA max @ 28V AC/DC max

**41** — **D** — **C**

Terminals For TX & TZ Frames	
Straight PC with Bracket (1-2 Pole only)	
13	.250" (6.35mm) Straight PC with .465" (11.8mm) Bracket
15	.425" (10.8mm) Straight PC with .630" (16.0mm) Bracket
17	.964" (24.5mm) Straight PC with 1.150" (29.2mm) Bracket
Straight PC with Reinforced Bracket (1-2 Pole only)	
23	.250" (6.35mm) Straight PC with .465" (11.8mm) Bracket
25	.425" (10.8mm) Straight PC with .630" (16.0mm) Bracket
26	.750" (19.05mm) Straight PC with .953" (24.2mm) Bracket
Terminals For TX Frame Only	
Right Angle PC with Support (1-3 Pole only)	
30	.150" (3.81mm) Right Angle PC
Vertical PC with Support (1-4 Pole)	
41	.150" (3.81mm) Vertical PC

Rockers & Paddles	
Small Actuators (TX Frame)	
D	.365" (9.27mm) Wide Rocker
E	.365" (9.27mm) Wide Paddle
F	.450" (11.43mm) Wide Rocker
G	.450" (11.43mm) Wide Paddle
Large Actuators (TZ Frame)	
J	.595" (15.11mm) Wide Rocker
H	.595" (15.11mm) Wide Paddle

Rocker & Paddle Colors	
A	Black
B	White
C	Red
E	Yellow
F	Green
G	Blue
H	Gray

**IMPORTANT:**

Switches are supplied without UL & CSA marking unless specified. **UL & CSA recognized only when ordered with marking on the switch.** Specific models, ratings, & ordering instructions are noted on General Specifications page.

### DESCRIPTION FOR TYPICAL ORDERING EXAMPLE

**M2013TXG41-DC**



### DESCRIPTION FOR TYPICAL ORDERING EXAMPLE

**M2022TZG23-JC**

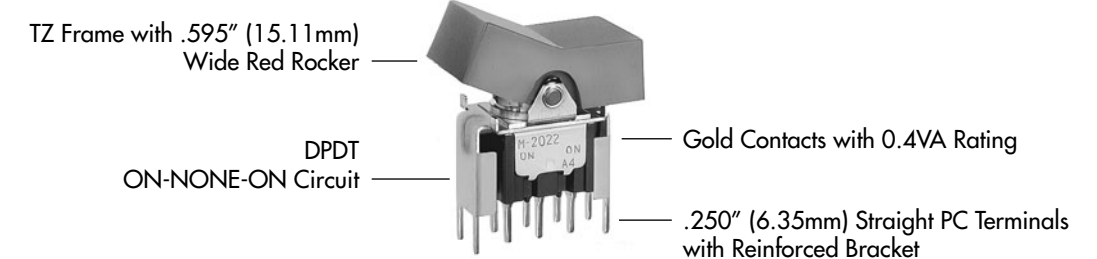

## POLES & CIRCUITS

Pole	Model	Rocker Position ( ) = Momentary			Connected Terminals			Throw & Schematics
		Down	Center	Up	Down	Center	Up	
SP	M2012 M2013 *M2015 M2018 *M2019	ON ON ON (ON) ON	NONE OFF NONE OFF OFF	ON ON (ON) (ON) (ON)	2-3	OPEN	2-1	Note: Terminal numbers are not actually on the switch. * Reverse circuits available for vertical mount SP & DP upon request.  SPDT 
DP	M2022 M2023 *M2025 M2028 *M2029	ON ON ON (ON) ON	NONE OFF NONE OFF OFF	ON ON (ON) (ON) (ON)	2-3 5-6	OPEN	2-1 5-4	DPDT 
3P	M2022 M2023 *M2025 M2028 *M2029	ON ON ON (ON) ON	NONE OFF NONE OFF OFF	ON ON (ON) (ON) (ON)	2-3 5-6 8-9	OPEN	2-1 5-4 8-7	3PDT 
4P	M2042 M2043 *M2045 M2048 *M2049	ON ON ON (ON) ON	NONE OFF NONE OFF OFF	ON ON (ON) (ON) (ON)	2-3 5-6 8-9 11-12	OPEN	2-1 5-4 8-7 11-10	4PDT 

For 3 Throw (3-On)

### Connected Terminals & Schematics

Pole	Model	Down	Center	Up	Down	Center	Up
SP	M2024 M2026 M2027	ON (ON) ON	ON ON ON	ON (ON) (ON)	 2-3 5-6	 2-3 5-4	 2-1 5-4
DP	M2044 M2046 M2047	ON (ON) ON	ON ON ON	ON (ON) (ON)	 2-3 5-6 8-9 11-12	 2-3 5-4 8-9 11-10	 2-1 5-4 8-7 11-10

The SP3T model utilizes a double pole base.



External connection must be made during field installation.

The DP3T model utilizes a four pole base.



External connection must be made during field installation.

MOUNTING FRAMES

**TX** Narrow Mounting Frame for Small Actuators with Straight PC Terminals (codes 13, 15, 17, 23, 25, & 26) or with Angle PC Terminals (codes 30 & 41)

Straight PC Mounting



Right Angle PC Mounting

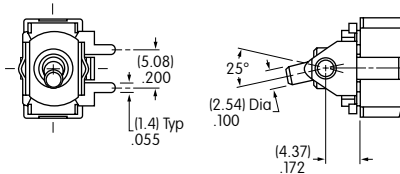

Vertical PC Mounting



Small Actuators & Panel Cutouts for TX Frame (actuator details on the following pages)

AT4148

AT4149

AT4150

AT4151



**TZ** Wide Mounting Frame for Large Actuators with Straight PC Terminals (codes 13, 15, 17, 23, 25, & 26)

Large Actuators & Panel Cutouts for TZ Frame (actuator details on the following pages)

AT4156

AT4157

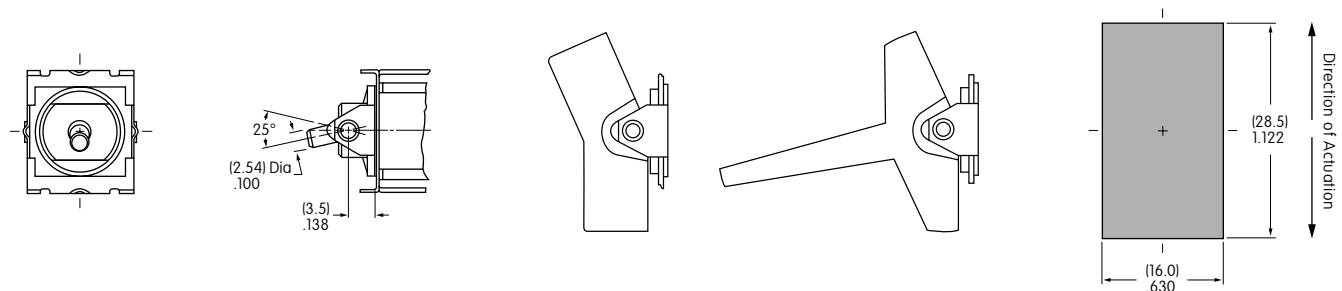

CONTACT MATERIALS & RATINGS

<b>W</b>	Silver over Silver	Power Level	6A @ 125V AC & 3A @ 250V AC
<b>G</b>	Gold over Brass or Copper	Logic Level	0.4VA maximum @ 28V AC/DC maximum
Note: See Supplement section to find complete explanation of operating range.			
<b>A</b>	Gold over Silver	Power Level or Logic Level	6A @ 125V AC or 0.4VA maximum @ 28V AC/DC maximum

Note: This dual rated option is suitable when two or more identical switches are used in logic and in power circuits within the same application. See Supplement section to find complete explanation of dual rating and operating range.

Toggles

Rockers **B**

Pushbuttons

Programmable Illuminated PB

Keylocks

Rotaries

Slides

Tactiles

Tilt

Touch

Indicators

Accessories

Supplement

## TERMINALS

For TX and TZ 1-2 Pole  
Straight PC Mount with Bracket

For TX and TZ 1-2 Pole  
Straight PC Mount with Reinforced Bracket

**13**

.250" (6.35mm)  
Terminal with  
.465" (11.8mm)  
Bracket

**15**

.425" (10.8mm)  
Terminal with  
.630" (16.0mm)  
Bracket

**17**

.964" (24.5mm)  
Terminal with  
1.150" (29.2mm)  
Bracket

**23**

.250" (6.35mm)  
Terminal with  
.465" (11.8mm)  
Bracket

**25**

.425" (10.8mm)  
Terminal with  
.630" (16.0mm)  
Bracket

**26**

.750" (19.05mm)  
Terminal with  
.953" (24.2mm)  
Bracket



PCB footprints are on the following Typical Switch Dimension pages.

For TX 1-3 Pole Right Angle PC Mount

For TX 1-4 Pole Vertical PC Mount

**30**

.150" (3.81mm)  
Right Angle PC



**41**

.150" (3.81mm)  
Vertical PC

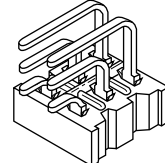

## ROCKERS & PADDLES FOR TX MOUNTING FRAMES

**D**

AT4148 .365" (9.27mm)  
Wide Rocker

Material: Polyamide  
Finish: Matte

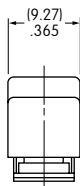

**E**

AT4149 .365" (9.27mm)  
Wide Paddle

Material: Polyamide  
Finish: Matte

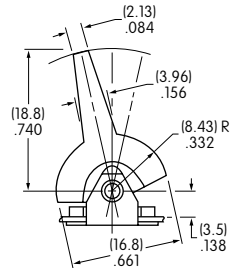

**F**

AT4150 .450" (11.43mm)  
Wide Rocker

Material: Polyamide  
Finish: Matte



**G**

AT4151 .450" (11.43mm)  
Wide Paddle

Material: Polyamide  
Finish: Matte

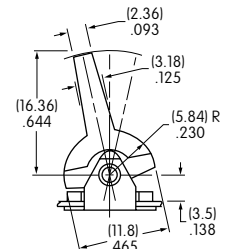

Cap Colors  
Available:

**A**

Black

**B**

White

**C**

Red

**E**

Yellow

**F**

Green

**G**

Blue

**H**

Gray

## ROCKERS & PADDLES FOR TZ MOUNTING FRAMES

### J AT4156 .595" (15.11mm) Wide Rocker

Material: Polyamide  
Finish: Matte



### H AT4157 .595" (15.11mm) Wide Paddle

Material: Polyamide  
Finish: Matte

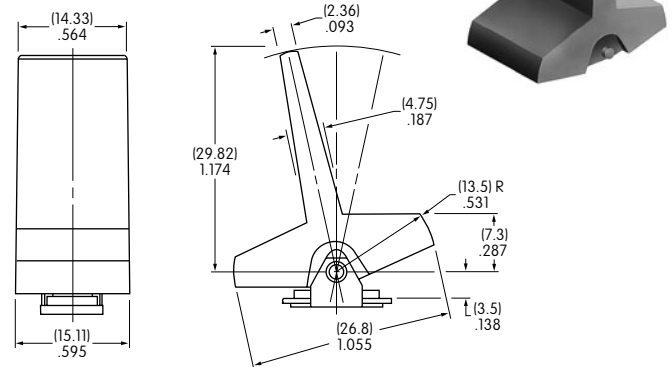

Cap Colors Available:



Black



White



Red



Yellow



Green



Blue



Gray

## OPTIONAL SNAP-IN PANEL FRAMES

Used with AT4148 Rocker and AT4149 Paddle

### AT064-1

Accommodates .047" ~ .090"  
(1.2 ~ 2.3mm) panel thickness

Material: Polyamide  
Finish: Matte  
Color: Black

Mounted separately from switches

Cutout Tolerances:

Dimension A:  
.797" ~ .803" (20.24 ~ 20.4mm)

Dimension B:  
.495" ~ .505" (12.57 ~ 12.83mm)

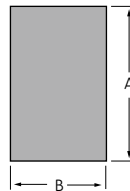

### AT064-2

Accommodates .062" ~ .125"  
(1.57 ~ 3.18mm) panel thickness

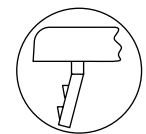
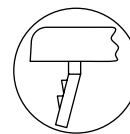
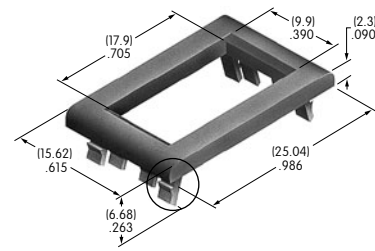

AT064-1 Enlarged Detail

Used with AT4150 Rocker and AT4151 Paddle

### AT065-1

Accommodates .047" ~ .090"  
(1.2 ~ 2.3mm) panel thickness

Material: Polyamide  
Finish: Matte  
Color: Black

Mounted separately from switches

Cutout Tolerances:

Dimension A:  
.595" ~ .605" (15.11 ~ 15.37mm)

Dimension B:  
.495" ~ .500" (12.57 ~ 12.7mm)



### AT065-2

Accommodates .062" ~ .125"  
(1.57 ~ 3.18mm) panel thickness

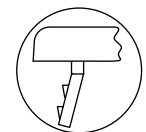
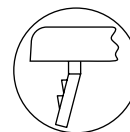
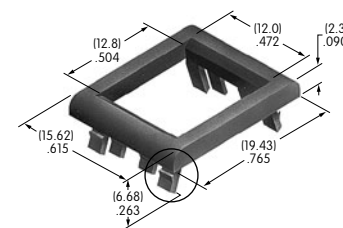

AT065-1 Enlarged Detail

AT065-2 Enlarged Detail

## TYPICAL SWITCH DIMENSIONS

### Straight PC • Bracket



**M2012TXG13-DC**

Terminal Code:	Terminal Length:	Bracket Length:
<b>13</b>	.250" (6.35mm)	.465" (11.8mm)
<b>15</b>	.425" (10.8mm)	.630" (16.0mm)
<b>17</b>	.964" (24.5mm)	1.150" (29.2mm)



### Straight PC • Reinforced Bracket



**M2012TXG23-DC**

Terminal Code:	Terminal Length:	Bracket Length:
<b>23</b>	.250" (6.35mm)	.465" (11.8mm)
<b>25</b>	.425" (10.8mm)	.630" (16.0mm)
<b>26</b>	.750" (19.05mm)	.953" (24.2mm)





## TYPICAL SWITCH DIMENSIONS

### Single Pole

### .150" (3.81 mm) Right Angle PC

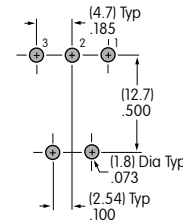

M2012TXG30-DC

### Double Pole

### .150" (3.81 mm) Right Angle PC

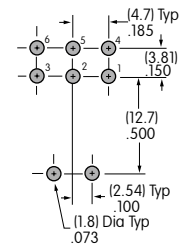
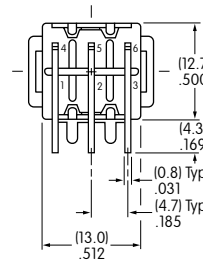
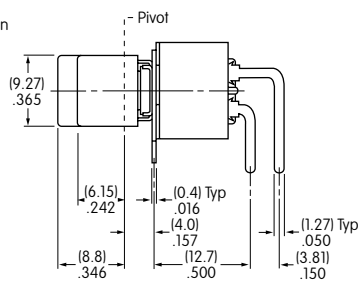
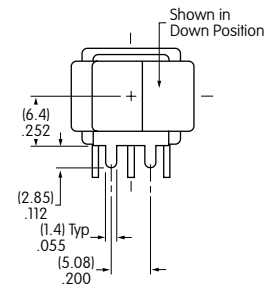

M2022TXG30-DC

### Three Pole

### .150" (3.81 mm) Right Angle PC

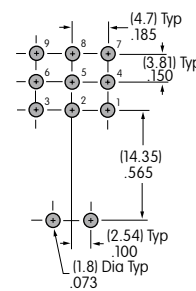
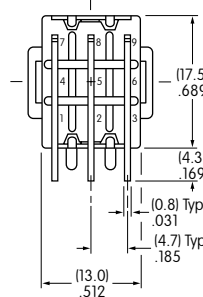
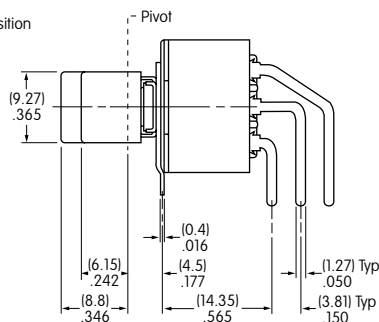
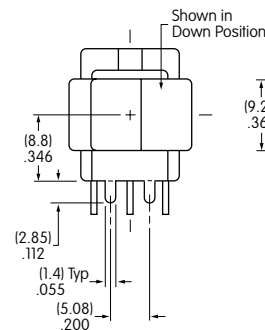

M2032TXG30-DC

## TYPICAL SWITCH DIMENSIONS

### .150" (3.81mm) Vertical PC

### Single Pole

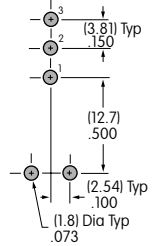
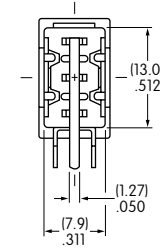
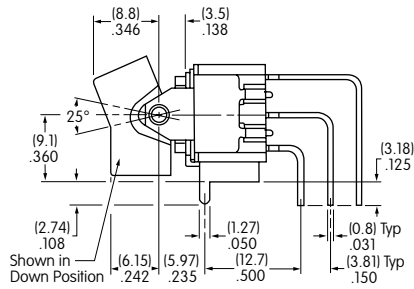
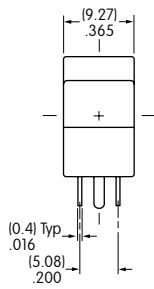

M2012TXG41-DC

### .150" (3.81mm) Vertical PC

### Double Pole

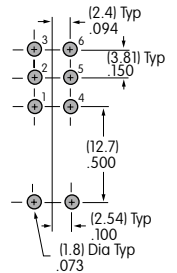
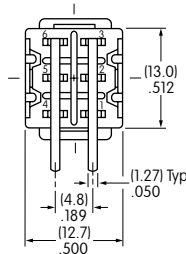
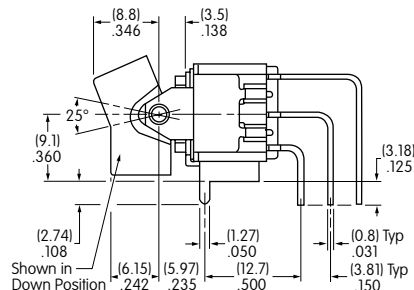
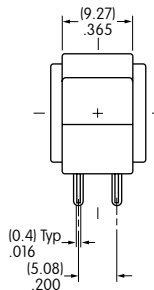

M2022TXG41-DC

### .150" (3.81mm) Vertical PC

### Three Pole

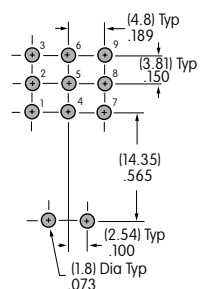
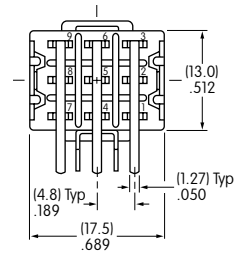
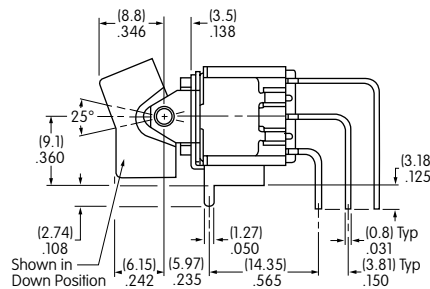
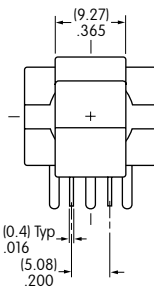

M2032TXG41-DC

### .150" (3.81mm) Vertical PC

### Four Pole

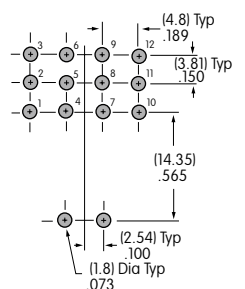
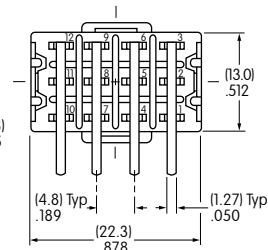
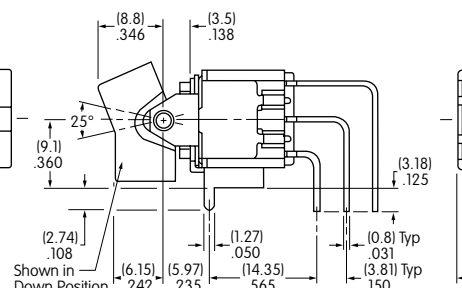
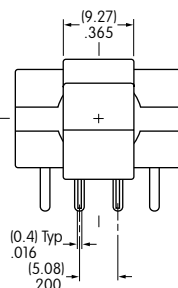

M2042TXG41-DC

Toggles

Rockers **B**

Pushbuttons

Illuminated PB

Programmable

Keylocks

Rotaries

Slides

Tactiles

Tilt

Touch

Indicators

Accessories

Supplement

## TYPICAL SWITCH DIMENSIONS

### Straight PC • Bracket

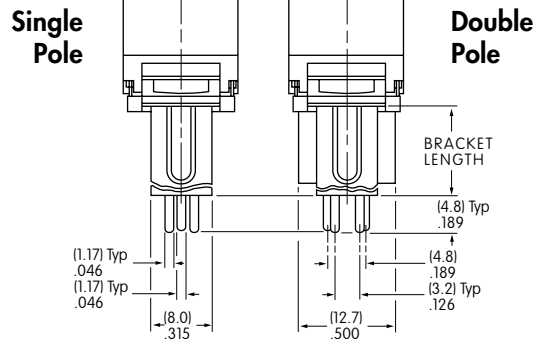
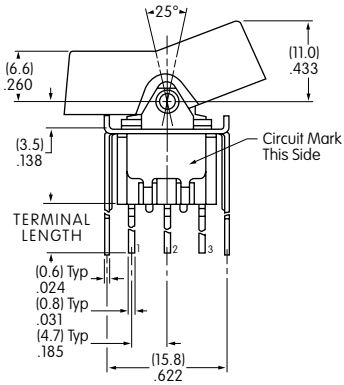

**M2012TZG13-JC**



Terminal Code:	Terminal Length:	Bracket Length:
<b>13</b>	.250" (6.35mm)	.465" (11.8mm)
<b>15</b>	.425" (10.8mm)	.630" (16.0mm)
<b>17</b>	.964" (24.5mm)	1.150" (29.2mm)

### Straight PC • Reinforced Bracket

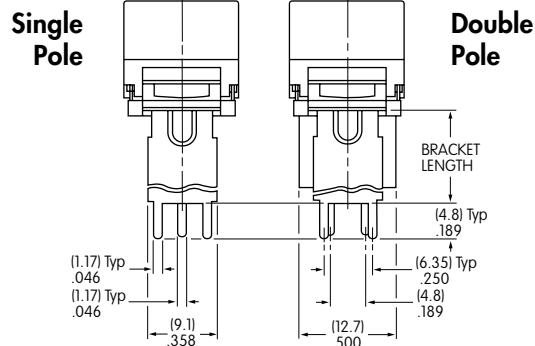
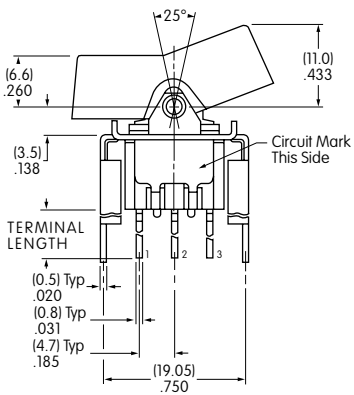

**M2012TZG23-JC**

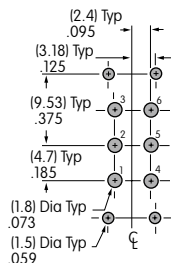
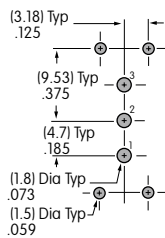

Terminal Code:	Terminal Length:	Bracket Length:
<b>23</b>	.250" (6.35mm)	.465" (11.8mm)
<b>25</b>	.425" (10.8mm)	.630" (16.0mm)
<b>26</b>	.750" (19.05mm)	.953" (24.2mm)

## LEGENDS

NKK Switches can provide custom legends for caps. Contact factory for more information.

### Suggested Printable Area for Cap

AT4148



AT4150



AT4156

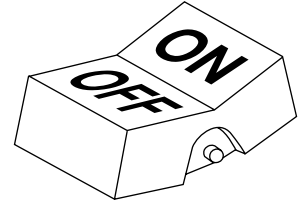

Shaded areas are printable areas.

### Recommended Print Method:

Pad Print

Epoxy based ink is recommended.



Компания «ЭлектроПласт» предлагает заключение долгосрочных отношений при поставках импортных электронных компонентов на взаимовыгодных условиях!

Наши преимущества:

- Оперативные поставки широкого спектра электронных компонентов отечественного и импортного производства напрямую от производителей и с крупнейших мировых складов;
- Поставка более 17-ти миллионов наименований электронных компонентов;
- Поставка сложных, дефицитных, либо снятых с производства позиций;
- Оперативные сроки поставки под заказ (от 5 рабочих дней);
- Экспресс доставка в любую точку России;
- Техническая поддержка проекта, помощь в подборе аналогов, поставка прототипов;
- Система менеджмента качества сертифицирована по Международному стандарту ISO 9001;
- Лицензия ФСБ на осуществление работ с использованием сведений, составляющих государственную тайну;
- Поставка специализированных компонентов (Xilinx, Altera, Analog Devices, Intersil, Interpoint, Microsemi, Aeroflex, Peregrine, Syfer, Eurofarad, Texas Instrument, Miteq, Cobham, E2V, MA-COM, Hittite, Mini-Circuits, General Dynamics и др.);

Помимо этого, одним из направлений компании «ЭлектроПласт» является направление «Источники питания». Мы предлагаем Вам помощь Конструкторского отдела:

- Подбор оптимального решения, техническое обоснование при выборе компонента;
- Подбор аналогов;
- Консультации по применению компонента;
- Поставка образцов и прототипов;
- Техническая поддержка проекта;
- Защита от снятия компонента с производства.



#### Как с нами связаться

**Телефон:** 8 (812) 309 58 32 (многоканальный)

**Факс:** 8 (812) 320-02-42

**Электронная почта:** [org@eplast1.ru](mailto:org@eplast1.ru)

**Адрес:** 198099, г. Санкт-Петербург, ул. Калинина, дом 2, корпус 4, литера А.