

# Common Mode Filters

For power line

## ACM series

Type:	<b>ACM4520</b>	<b>[1808 inch]*</b>
	<b>ACM7060</b>	<b>[2824 inch]</b>
	<b>ACM9070</b>	<b>[3628 inch]</b>
	<b>ACM1211</b>	<b>[4844 inch]</b>
	<b>ACM1513</b>	<b>[6052 inch]</b>

\* Dimensions Code [EIA]

Issue date: March 2013

- All specifications are subject to change without notice.
- Conformity to RoHS Directive: This means that, in conformity with EU Directive 2002/95/EC, lead, cadmium, mercury, hexavalent chromium, and specific bromine-based flame retardants, PBB and PBDE, have not been used, except for exempted applications.

# Common Mode Filters For Power Line

Conformity to RoHS Directive

## ACM Series ACM4520

### FEATURES

- Several large current products are prepared to correspond to the various applications.
- Low profile and compact shape, it is suited for surface mounting.
- It shows high common mode impedance despite of its compact shape.

### APPLICATIONS

Radiation noise suppression for power line (DVC, DVD cam, DSC, etc.)

### TEMPERATURE RANGES

Operating	-40 to +85°C
Storage(After mount)	-40 to +85°C

### PACKAGING STYLE AND QUANTITIES

Packaging style	Reel	Quantity
Taping	ø180mm	800 pieces/reel
	ø330mm	2500 pieces/reel

### PRODUCT IDENTIFICATION

ACM	4520	-	901	-	2P	-	T	-	□□□
(1)	(2)	(3)	(4)	(5)	(6)				

- (1) Series name
- (2) Dimensions W×T  
4520: 4.5×2.0mm
- (3) Impedance [at 100MHz]  
901: 900Ω
- (4) Numbers of lines  
2P: 2-line
- (5) Packaging style  
T: ø180mm reel taping  
TL: ø330mm reel taping
- (6) TDK internal code

### RECOMMENDED SOLDERING CONDITIONS

#### RECOMMENDED TEMPERATURE PROFILE FOR LEAD-FREE SOLDER

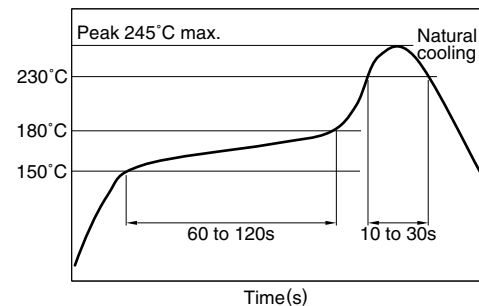

#### REFLOW PROFILE FOR SOLDER HEAT RESISTANCE

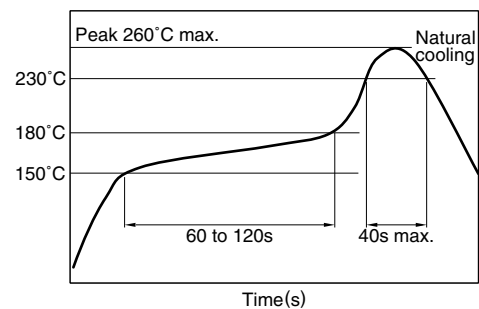

• Conformity to RoHS Directive: This means that, in conformity with EU Directive 2002/95/EC, lead, cadmium, mercury, hexavalent chromium, and specific bromine-based flame retardants, PBB and PBDE, have not been used, except for exempted applications.

• All specifications are subject to change without notice.

## SHAPES AND DIMENSIONS

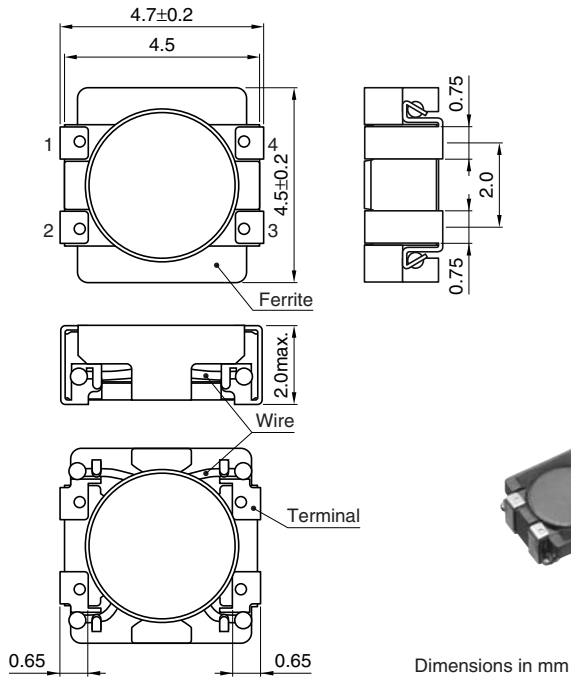

## CIRCUIT DIAGRAM

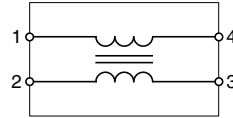

• No polarity

## RECOMMENDED PC BOARD PATTERN

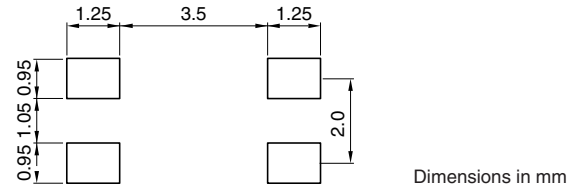

## ELECTRICAL CHARACTERISTICS

Part No.	Common mode impedance ( $\Omega$ )[at 100MHz]		DC resistance ( $\Omega$ )max. [1 line]	Rated current $I_{dc}$ (A)max.		Rated voltage $E_{dc}$ (V)max.	Insulation resistance ( $M\Omega$ )min.
	min.	typ.		60°C	85°C		
ACM4520-231-2P	180	230	0.05	3.0	2.6	50	10
ACM4520-421-2P	300	420	0.055	2.8	2.4	50	10
ACM4520-901-2P	650	900	0.06	2.3	2.0	50	10
ACM4520-142-2P	1000	1400	0.08	1.7	1.5	50	10

**TYPICAL ELECTRICAL CHARACTERISTICS**  
**IMPEDANCE vs. FREQUENCY CHARACTERISTICS**  
**ACM4520-231-2P**

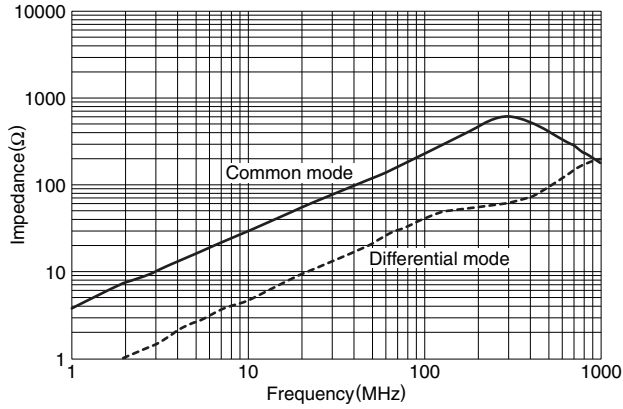

**ACM4520-421-2P**

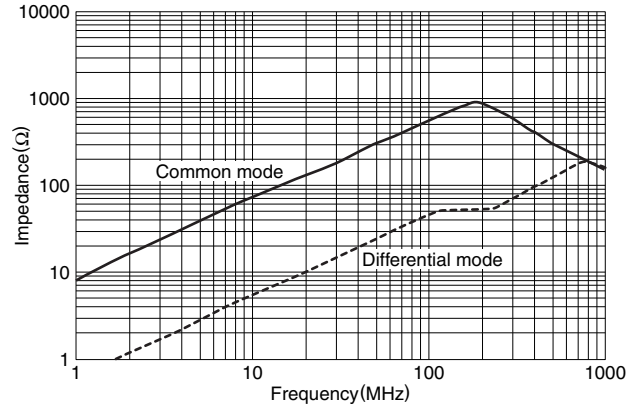

**ACM4520-901-2P**

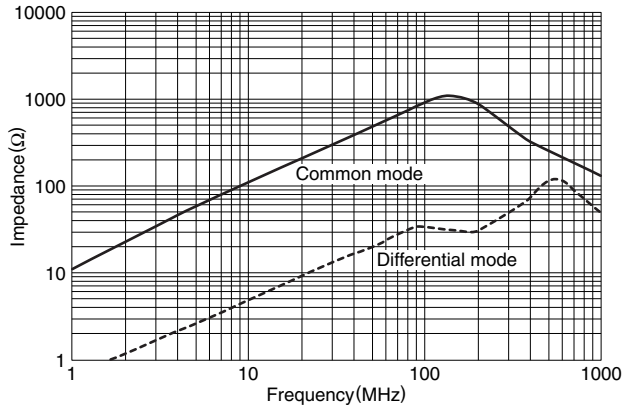

**ACM4520-142-2P**

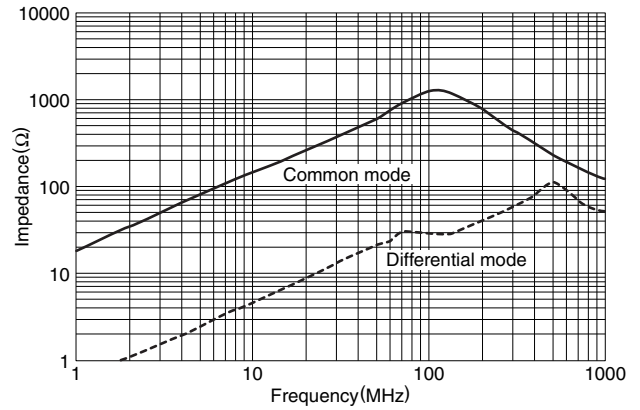

# Common Mode Filters For Power Line

Conformity to RoHS Directive

## ACM Series ACM7060, 9070, 1211, 1513

### FEATURES

- A chip-type common mode filter for large current applications. Common mode impedance surpasses 300 to 1000Ω at 100MHz. Noise is greatly suppressed.
- Capable of handling the highest current (up to 10A) of any chip-type common mode filter.
- Height and size have been considered, resulting in a compact and light-weight choke coil. Applicable for the miniaturization required to reduce the size and weight of portable equipment.
- The products contain no lead and also support lead-free soldering.
- This product does not contain regulated substances that are slated to be included in RoHS.

### APPLICATIONS

Used for power line noise suppression for any electronic devices  
Used to counter adapter/battery line noise for relatively large electronic devices such as notebook PCs, stand-alone word processors, etc

### TEMPERATURE RANGES

Operating	-40 to +85°C
Storage(After mount)	-40 to +85°C

### PACKAGING STYLE AND QUANTITIES

Packaging style	Type	Reel	Quantity
Taping	ACM7060	ø330mm	1500 pieces/reel
	ACM9070	ø330mm	800 pieces/reel
	ACM1211	ø330mm	500 pieces/reel
	ACM1513	ø330mm	500 pieces/reel

### PRODUCT IDENTIFICATION

ACM 7060 - 701 - 2PL - TL □□□  
(1) (2) (3) (4) (5) (6)

- (1) Series
- (2) Dimensions L×W  
7060: 7.0×6.0mm
- (3) Impedance[at 100MHz]  
701: 700Ω
- (4) Number of lines  
2PL: 2-line
- (5) Packaging style  
T: ø180mm reel taping  
TL: ø330mm reel taping
- (6) TDK internal code

### RECOMMENDED SOLDERING CONDITIONS RECOMMENDED TEMPERATURE PROFILE FOR LEAD-FREE SOLDER

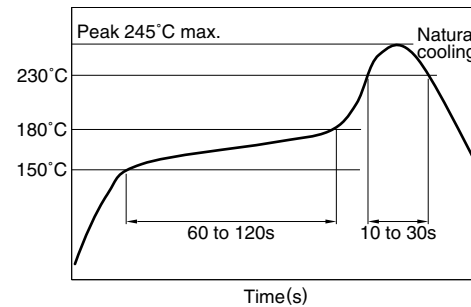

### REFLOW PROFILE FOR SOLDER HEAT RESISTANCE

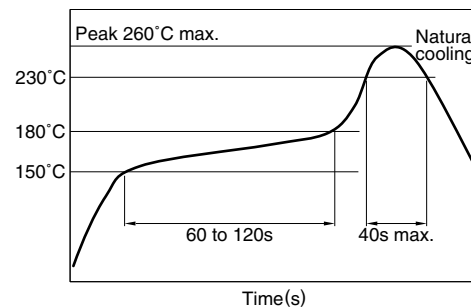

• Conformity to RoHS Directive: This means that, in conformity with EU Directive 2002/95/EC, lead, cadmium, mercury, hexavalent chromium, and specific bromine-based flame retardants, PBB and PBDE, have not been used, except for exempted applications.

• All specifications are subject to change without notice.

SHAPES AND DIMENSIONS/CIRCUIT DIAGRAM/RECOMMENDED PC BOARD PATTERN(REFLOW SOLDERING)

ACM7060 TYPE

ACM7060-301-2PL-TL01

ACM7060-701-2PL-TL01

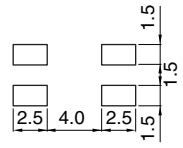
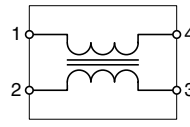
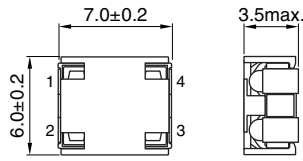
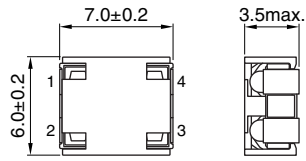

Dimensions in mm

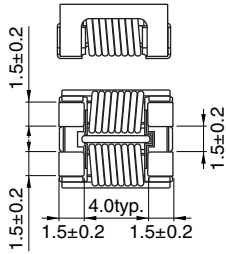
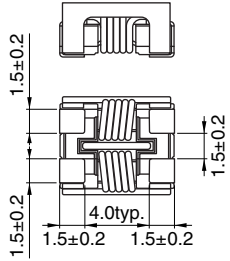

Weight: 0.35g  
Dimensions in mm



ACM9070 TYPE

ACM9070-701-2PL-TL01

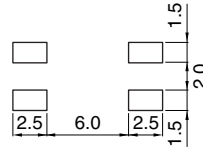
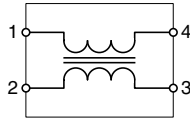
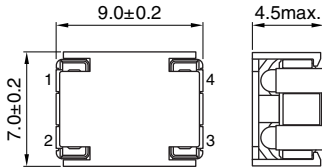

Dimensions in mm

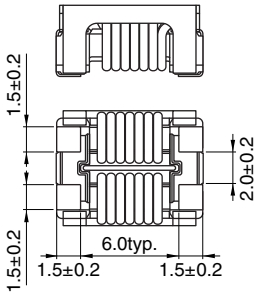

Weight: 0.82g  
Dimensions in mm



SHAPES AND DIMENSIONS/CIRCUIT DIAGRAM/RECOMMENDED PC BOARD PATTERN(REFLOW SOLDERING)

ACM1211 TYPE

ACM1211-701-2PL-TL01

ACM1211-102-2PL-TL01

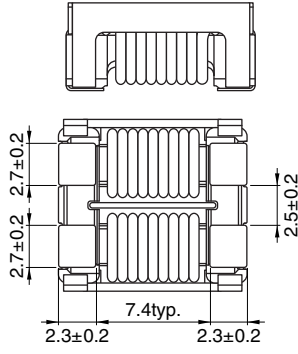
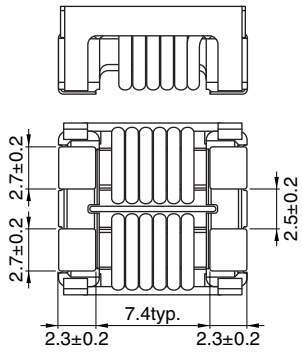
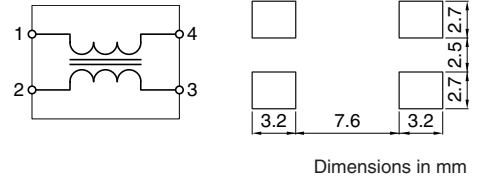
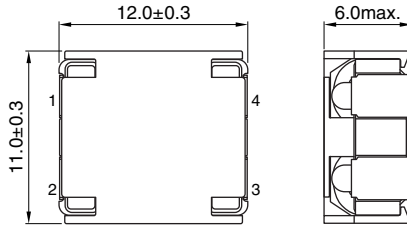
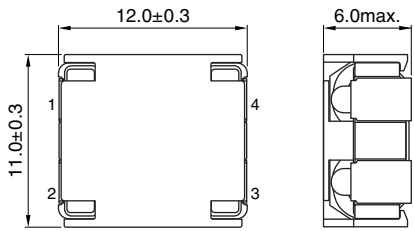

Weight: 2.20g  
Dimensions in mm

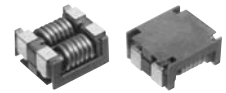

ACM1513 TYPE

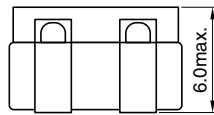
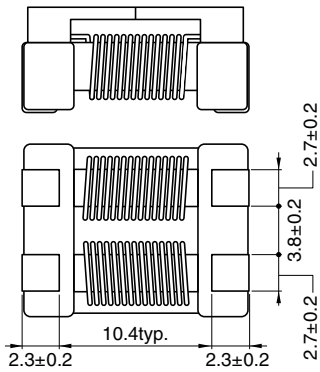
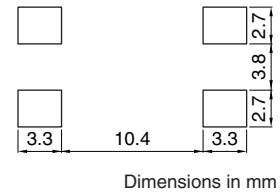
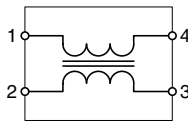
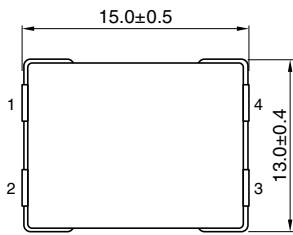

Weight: 3.15g  
Dimensions in mm

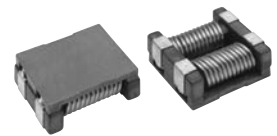

• All specifications are subject to change without notice.

## ELECTRICAL CHARACTERISTICS

Part No.	Impedance ( $\Omega$ ) [at 100MHz]		DC resistance ( $m\Omega$ ) max.	Rated current $I_{dc}$ (A) max.	Insulation resistance ( $M\Omega$ ) min.	Rated voltage $E_{dc}$ (V) max.
	min.	typ.				
ACM7060-301-2PL-TL01	225	300	10	5	10	80
ACM7060-701-2PL-TL01	500	700	15	4	10	80
ACM9070-701-2PL-TL01	500	700	10	5	10	80
ACM1211-701-2PL-TL01	500	700	6	8	10	80
ACM1211-102-2PL-TL01	750	1000	14	6	10	80
ACM1513-551-2PL-TLHF	450	550	4	10	10	50

## TYPICAL ELECTRICAL CHARACTERISTICS

### IMPEDANCE vs. FREQUENCY CHARACTERISTICS

ACM7060-301-2PL-TL01

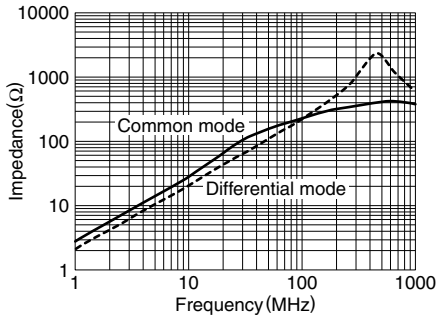

ACM7060-701-2PL-TL01

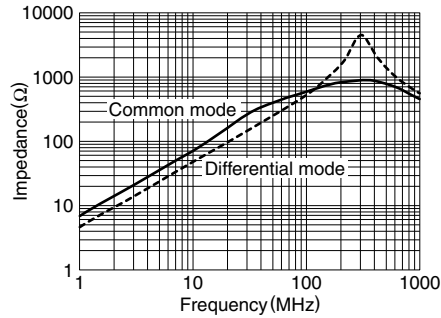

ACM9070-701-2PL-TL01

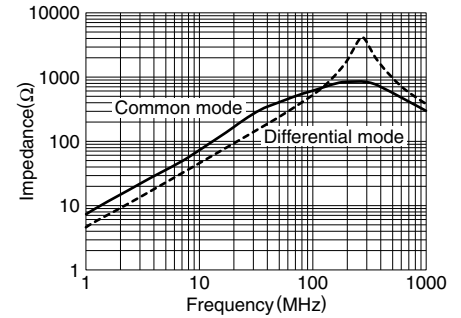

ACM1211-701-2PL-TL01

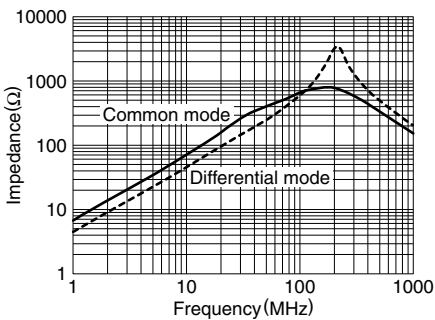

ACM1211-102-2PL-TL01

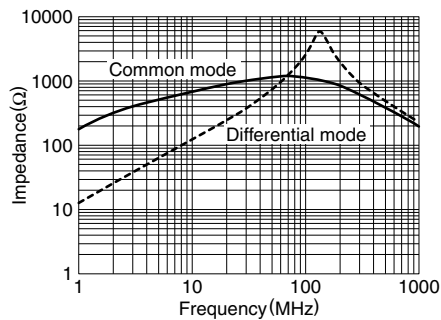

ACM1513-551-2PL-TLHF

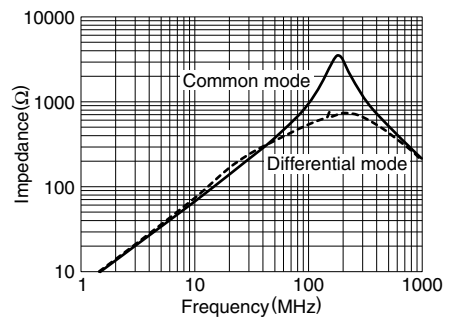

## MEASURING CIRCUITS

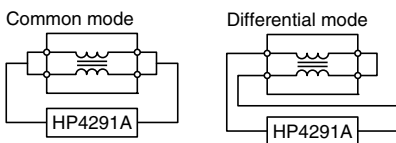





Компания «ЭлектроПласт» предлагает заключение долгосрочных отношений при поставках импортных электронных компонентов на взаимовыгодных условиях!

Наши преимущества:

- Оперативные поставки широкого спектра электронных компонентов отечественного и импортного производства напрямую от производителей и с крупнейших мировых складов;
- Поставка более 17-ти миллионов наименований электронных компонентов;
- Поставка сложных, дефицитных, либо снятых с производства позиций;
- Оперативные сроки поставки под заказ (от 5 рабочих дней);
- Экспресс доставка в любую точку России;
- Техническая поддержка проекта, помощь в подборе аналогов, поставка прототипов;
- Система менеджмента качества сертифицирована по Международному стандарту ISO 9001;
- Лицензия ФСБ на осуществление работ с использованием сведений, составляющих государственную тайну;
- Поставка специализированных компонентов (Xilinx, Altera, Analog Devices, Intersil, Interpoint, Microsemi, Aeroflex, Peregrine, Syfer, Eurofarad, Texas Instrument, Miteq, Cobham, E2V, MA-COM, Hittite, Mini-Circuits, General Dynamics и др.);

Помимо этого, одним из направлений компании «ЭлектроПласт» является направление «Источники питания». Мы предлагаем Вам помощь Конструкторского отдела:

- Подбор оптимального решения, техническое обоснование при выборе компонента;
- Подбор аналогов;
- Консультации по применению компонента;
- Поставка образцов и прототипов;
- Техническая поддержка проекта;
- Защита от снятия компонента с производства.



#### Как с нами связаться

**Телефон:** 8 (812) 309 58 32 (многоканальный)

**Факс:** 8 (812) 320-02-42

**Электронная почта:** [org@eplast1.ru](mailto:org@eplast1.ru)

**Адрес:** 198099, г. Санкт-Петербург, ул. Калинина, дом 2, корпус 4, литера А.