

Common Mode Filters

For power line

ACM series

| | | |
|-------|----------------|---------------------|
| Type: | ACM4520 | [1808 inch]* |
| | ACM7060 | [2824 inch] |
| | ACM9070 | [3628 inch] |
| | ACM1211 | [4844 inch] |
| | ACM1513 | [6052 inch] |

* Dimensions Code [EIA]

Issue date: March 2013

- All specifications are subject to change without notice.
- Conformity to RoHS Directive: This means that, in conformity with EU Directive 2002/95/EC, lead, cadmium, mercury, hexavalent chromium, and specific bromine-based flame retardants, PBB and PBDE, have not been used, except for exempted applications.

Common Mode Filters For Power Line

Conformity to RoHS Directive

ACM Series ACM4520

FEATURES

- Several large current products are prepared to correspond to the various applications.
- Low profile and compact shape, it is suited for surface mounting.
- It shows high common mode impedance despite of its compact shape.

APPLICATIONS

Radiation noise suppression for power line (DVC, DVD cam, DSC, etc.)

TEMPERATURE RANGES

| | |
|----------------------|--------------|
| Operating | -40 to +85°C |
| Storage(After mount) | -40 to +85°C |

PACKAGING STYLE AND QUANTITIES

| Packaging style | Reel | Quantity |
|-----------------|--------|------------------|
| Taping | ø180mm | 800 pieces/reel |
| | ø330mm | 2500 pieces/reel |

PRODUCT IDENTIFICATION

| | | | | | | | | | |
|-----|------|-----|-----|-----|-----|---|---|---|-----|
| ACM | 4520 | - | 901 | - | 2P | - | T | - | □□□ |
| (1) | (2) | (3) | (4) | (5) | (6) | | | | |

- (1) Series name
- (2) Dimensions W×T
4520: 4.5×2.0mm
- (3) Impedance [at 100MHz]
901: 900Ω
- (4) Numbers of lines
2P: 2-line
- (5) Packaging style
T: ø180mm reel taping
TL: ø330mm reel taping
- (6) TDK internal code

RECOMMENDED SOLDERING CONDITIONS

RECOMMENDED TEMPERATURE PROFILE FOR LEAD-FREE SOLDER

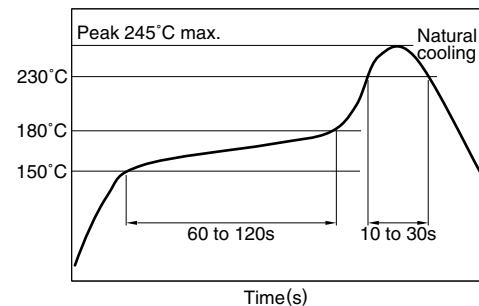

REFLOW PROFILE FOR SOLDER HEAT RESISTANCE

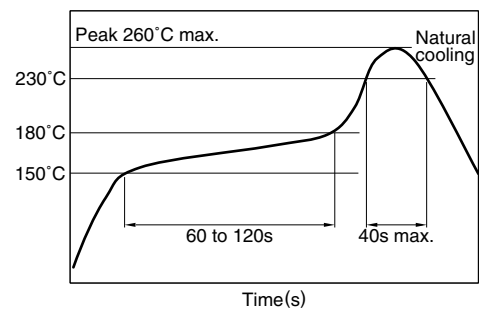

• Conformity to RoHS Directive: This means that, in conformity with EU Directive 2002/95/EC, lead, cadmium, mercury, hexavalent chromium, and specific bromine-based flame retardants, PBB and PBDE, have not been used, except for exempted applications.

• All specifications are subject to change without notice.

SHAPES AND DIMENSIONS

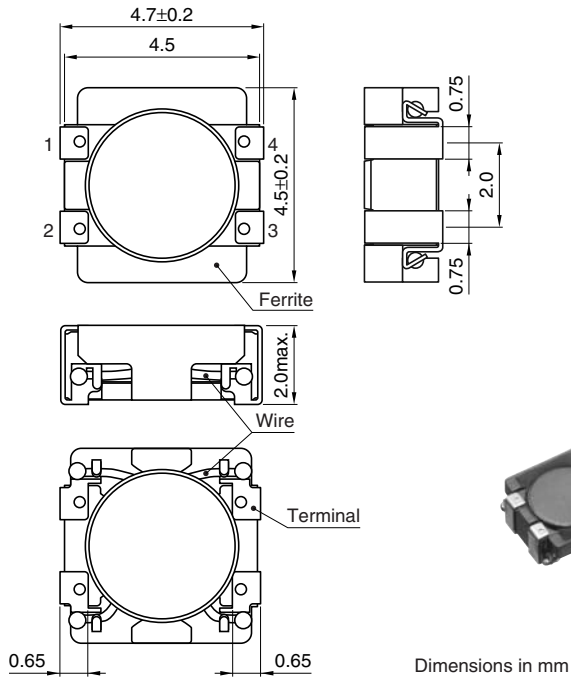

CIRCUIT DIAGRAM

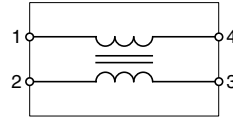

• No polarity

RECOMMENDED PC BOARD PATTERN

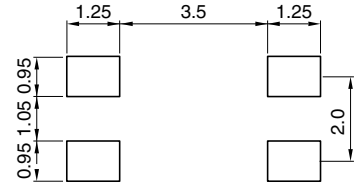

Dimensions in mm

ELECTRICAL CHARACTERISTICS

| Part No. | Common mode impedance (Ω)[at 100MHz] | | DC resistance (Ω)max. [1 line] | Rated current I_{dc} (A)max. | | Rated voltage E_{dc} (V)max. | Insulation resistance ($M\Omega$)min. |
|----------------|---|------|---|--------------------------------|------|--------------------------------|---|
| | min. | typ. | | 60°C | 85°C | | |
| ACM4520-231-2P | 180 | 230 | 0.05 | 3.0 | 2.6 | 50 | 10 |
| ACM4520-421-2P | 300 | 420 | 0.055 | 2.8 | 2.4 | 50 | 10 |
| ACM4520-901-2P | 650 | 900 | 0.06 | 2.3 | 2.0 | 50 | 10 |
| ACM4520-142-2P | 1000 | 1400 | 0.08 | 1.7 | 1.5 | 50 | 10 |

TYPICAL ELECTRICAL CHARACTERISTICS
IMPEDANCE vs. FREQUENCY CHARACTERISTICS
ACM4520-231-2P

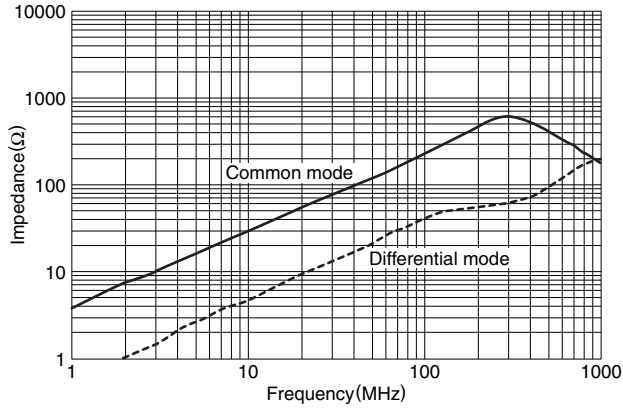

ACM4520-421-2P

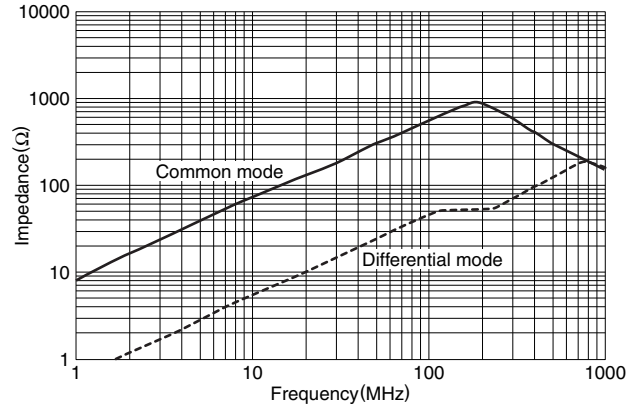

ACM4520-901-2P

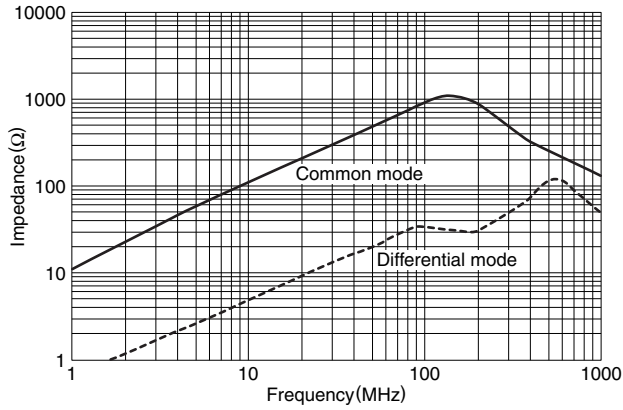

ACM4520-142-2P

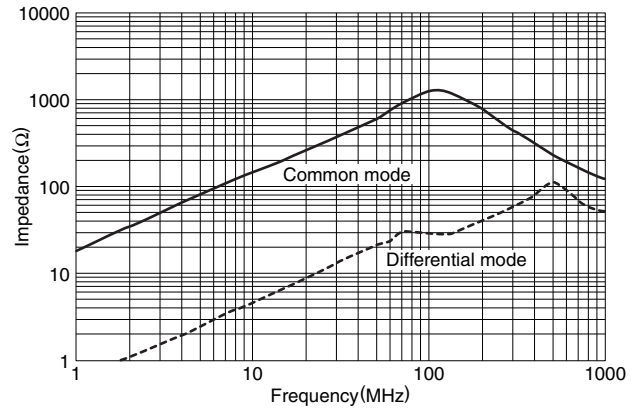

Common Mode Filters For Power Line

Conformity to RoHS Directive

ACM Series ACM7060, 9070, 1211, 1513

FEATURES

- A chip-type common mode filter for large current applications. Common mode impedance surpasses 300 to 1000Ω at 100MHz. Noise is greatly suppressed.
- Capable of handling the highest current (up to 10A) of any chip-type common mode filter.
- Height and size have been considered, resulting in a compact and light-weight choke coil. Applicable for the miniaturization required to reduce the size and weight of portable equipment.
- The products contain no lead and also support lead-free soldering.
- This product does not contain regulated substances that are slated to be included in RoHS.

APPLICATIONS

Used for power line noise suppression for any electronic devices
Used to counter adapter/battery line noise for relatively large electronic devices such as notebook PCs, stand-alone word processors, etc

TEMPERATURE RANGES

| | |
|----------------------|--------------|
| Operating | -40 to +85°C |
| Storage(After mount) | -40 to +85°C |

PACKAGING STYLE AND QUANTITIES

| Packaging style | Type | Reel | Quantity |
|-----------------|---------|--------|------------------|
| Taping | ACM7060 | ø330mm | 1500 pieces/reel |
| | ACM9070 | ø330mm | 800 pieces/reel |
| | ACM1211 | ø330mm | 500 pieces/reel |
| | ACM1513 | ø330mm | 500 pieces/reel |

PRODUCT IDENTIFICATION

ACM 7060 - 701 - 2PL - TL □□□
(1) (2) (3) (4) (5) (6)

- (1) Series
- (2) Dimensions L×W
7060: 7.0×6.0mm
- (3) Impedance[at 100MHz]
701: 700Ω
- (4) Number of lines
2PL: 2-line
- (5) Packaging style
T: ø180mm reel taping
TL: ø330mm reel taping
- (6) TDK internal code

RECOMMENDED SOLDERING CONDITIONS RECOMMENDED TEMPERATURE PROFILE FOR LEAD-FREE SOLDER

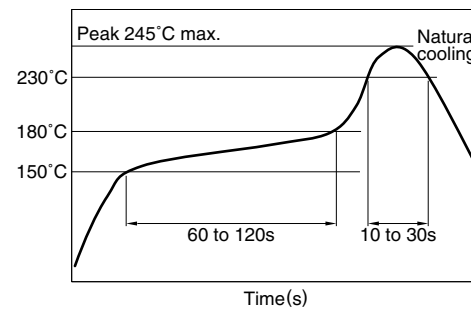

REFLOW PROFILE FOR SOLDER HEAT RESISTANCE

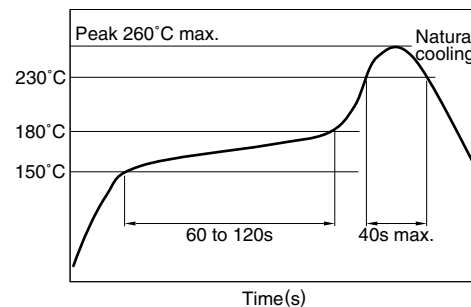

• Conformity to RoHS Directive: This means that, in conformity with EU Directive 2002/95/EC, lead, cadmium, mercury, hexavalent chromium, and specific bromine-based flame retardants, PBB and PBDE, have not been used, except for exempted applications.

• All specifications are subject to change without notice.

SHAPES AND DIMENSIONS/CIRCUIT DIAGRAM/RECOMMENDED PC BOARD PATTERN(REFLOW SOLDERING)

ACM7060 TYPE

ACM7060-301-2PL-TL01

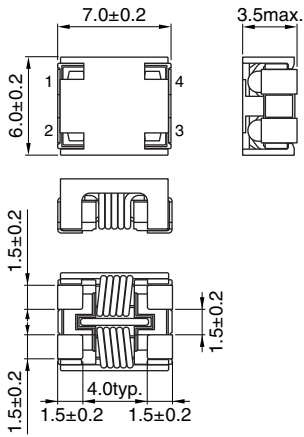

ACM7060-701-2PL-TL01

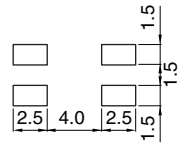
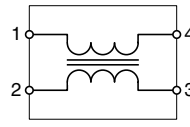
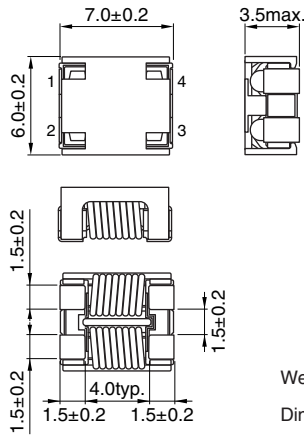

Dimensions in mm



Weight: 0.35g

Dimensions in mm

ACM9070 TYPE

ACM9070-701-2PL-TL01

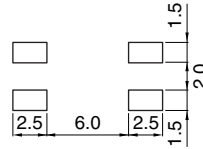
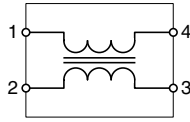
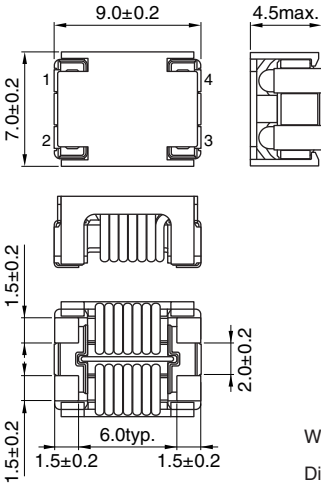

Dimensions in mm



Weight: 0.82g

Dimensions in mm

SHAPES AND DIMENSIONS/CIRCUIT DIAGRAM/RECOMMENDED PC BOARD PATTERN(REFLOW SOLDERING)

ACM1211 TYPE

ACM1211-701-2PL-TL01

ACM1211-102-2PL-TL01

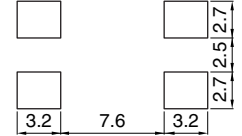
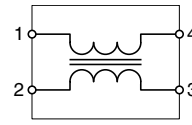
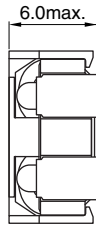
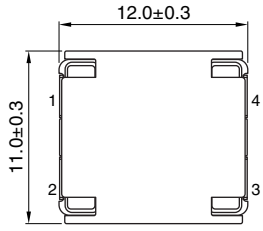
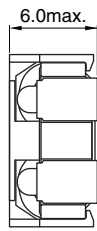
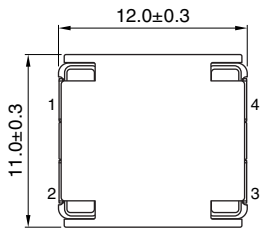

Dimensions in mm

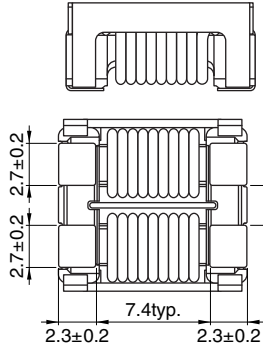
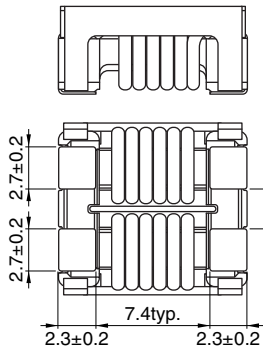

Weight: 2.20g

Dimensions in mm

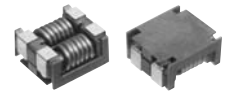

ACM1513 TYPE

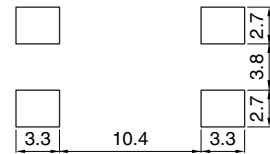
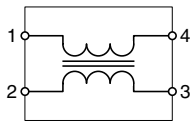
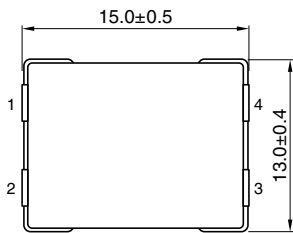

Dimensions in mm

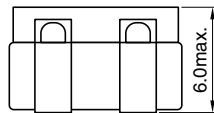
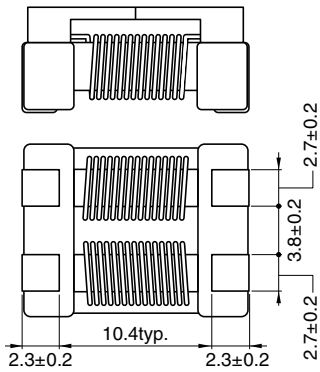

Weight: 3.15g

Dimensions in mm

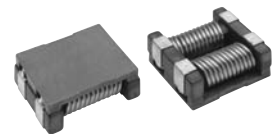

ELECTRICAL CHARACTERISTICS

| Part No. | Impedance (Ω) [at 100MHz] | | DC resistance ($m\Omega$) max. | Rated current I_{dc} (A) max. | Insulation resistance ($M\Omega$) min. | Rated voltage E_{dc} (V) max. |
|----------------------|------------------------------------|------|----------------------------------|---------------------------------|--|---------------------------------|
| | min. | typ. | | | | |
| ACM7060-301-2PL-TL01 | 225 | 300 | 10 | 5 | 10 | 80 |
| ACM7060-701-2PL-TL01 | 500 | 700 | 15 | 4 | 10 | 80 |
| ACM9070-701-2PL-TL01 | 500 | 700 | 10 | 5 | 10 | 80 |
| ACM1211-701-2PL-TL01 | 500 | 700 | 6 | 8 | 10 | 80 |
| ACM1211-102-2PL-TL01 | 750 | 1000 | 14 | 6 | 10 | 80 |
| ACM1513-551-2PL-TLHF | 450 | 550 | 4 | 10 | 10 | 50 |

TYPICAL ELECTRICAL CHARACTERISTICS

IMPEDANCE vs. FREQUENCY CHARACTERISTICS

ACM7060-301-2PL-TL01

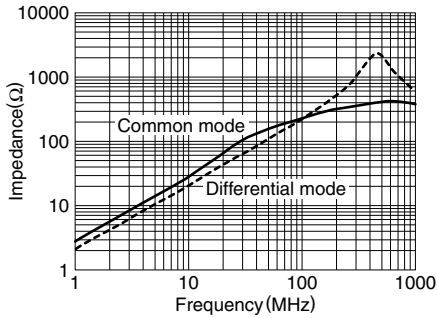

ACM7060-701-2PL-TL01

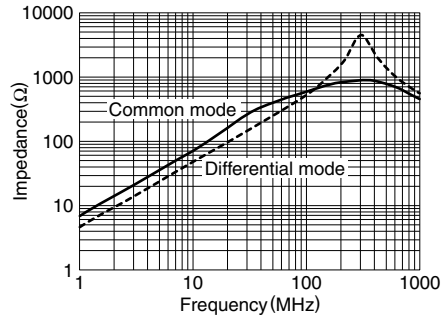

ACM9070-701-2PL-TL01

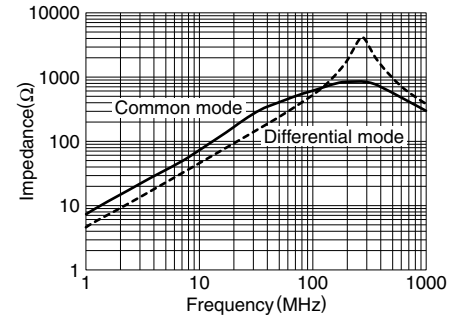

ACM1211-701-2PL-TL01

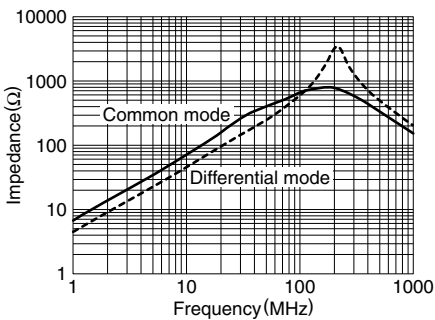

ACM1211-102-2PL-TL01

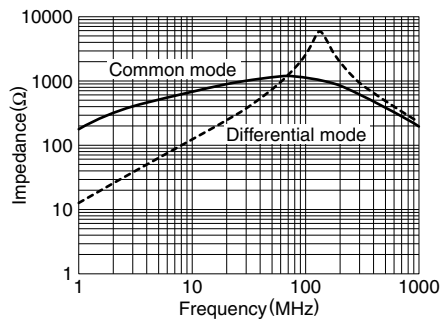

ACM1513-551-2PL-TLHF

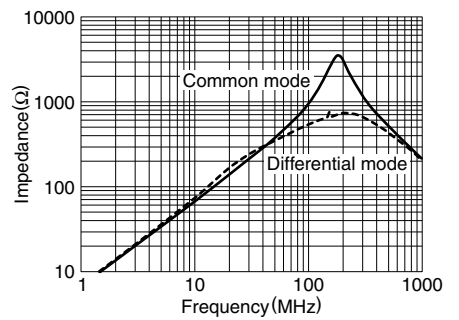

MEASURING CIRCUITS

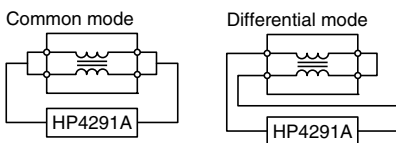



Компания «ЭлектроПласт» предлагает заключение долгосрочных отношений при поставках импортных электронных компонентов на взаимовыгодных условиях!

Наши преимущества:

- Оперативные поставки широкого спектра электронных компонентов отечественного и импортного производства напрямую от производителей и с крупнейших мировых складов;
- Поставка более 17-ти миллионов наименований электронных компонентов;
- Поставка сложных, дефицитных, либо снятых с производства позиций;
- Оперативные сроки поставки под заказ (от 5 рабочих дней);
- Экспресс доставка в любую точку России;
- Техническая поддержка проекта, помощь в подборе аналогов, поставка прототипов;
- Система менеджмента качества сертифицирована по Международному стандарту ISO 9001;
- Лицензия ФСБ на осуществление работ с использованием сведений, составляющих государственную тайну;
- Поставка специализированных компонентов (Xilinx, Altera, Analog Devices, Intersil, Interpoint, Microsemi, Aeroflex, Peregrine, Syfer, Eurofarad, Texas Instrument, Miteq, Cobham, E2V, MA-COM, Hittite, Mini-Circuits, General Dynamics и др.);

Помимо этого, одним из направлений компании «ЭлектроПласт» является направление «Источники питания». Мы предлагаем Вам помощь Конструкторского отдела:

- Подбор оптимального решения, техническое обоснование при выборе компонента;
- Подбор аналогов;
- Консультации по применению компонента;
- Поставка образцов и прототипов;
- Техническая поддержка проекта;
- Защита от снятия компонента с производства.



Как с нами связаться

Телефон: 8 (812) 309 58 32 (многоканальный)

Факс: 8 (812) 320-02-42

Электронная почта: org@eplast1.ru

Адрес: 198099, г. Санкт-Петербург, ул. Калинина, дом 2, корпус 4, литера А.