

# General Specifications

## Electrical Capacity (Resistive Load)

|  |   |
|--|---|
| <b>Power Level (silver):</b>                     | 1A @ 125V AC or 1A @ 30V DC   |
| <b>Logic Level (gold):</b>                       | 0.4VA maximum @ 28V AC/DC maximum<br>(Applicable Range 0.1mA ~ 0.1A @ 20mV ~ 28V) |
| <b>Logic/Power Level:<br/>(gold over silver)</b> | Combines silver & gold ratings  |

Note: Find additional explanation of dual rating & operating range in Supplement section.

## Other Ratings

|                                 |  |
|---------------------------------|--|
| <b>Contact Resistance:</b>      | 20 milliohms maximum for silver; 30 milliohms maximum for gold   |
| <b>Insulation Resistance:</b>   | 1,000 megohms minimum @ 500V DC  |
| <b>Dielectric Strength:</b>     | 1,000V AC minimum between contacts for 1 minute minimum;<br>1,500V AC minimum between contacts & case for 1 minute minimum |
| <b>Mechanical Life:</b>         | 200,000 operations minimum   |
| <b>Electrical Life:</b>         | 25,000 operations minimum for silver; 100,000 operations minimum for gold  |
| <b>Nominal Operating Force:</b> | Single pole 2.94N & double pole 4.90N  |
| <b>Contact Timing:</b>          | Nonshorting (break-before-make)  |
| <b>Travel:</b>                  | Pretravel .023" (0.6mm); Overtravel .016" (0.4mm); Total Travel .039" (1.0mm)  |

## Materials & Finishes

|                             |   |
|-----------------------------|---|
| <b>Plunger:</b>             | Brass with nickel plating   |
| <b>Support Bracket:</b>     | Brass with tin plating  |
| <b>Bushing/Housing:</b>     | Glass fiber reinforced polyamide (UL94V-0)  |
| <b>Sealing Ring:</b>        | Nitrile butadiene rubber  |
| <b>Base:</b>                | Glass fiber reinforced polyamide (UL94V-0)  |
| <b>Movable Contacts:</b>    | Silver alloy with silver plating (code W); copper with gold plating (code G);<br>or silver alloy with gold plating (code A) |
| <b>Stationary Contacts:</b> | Silver alloy with silver plating (code W); copper with gold plating (code G);<br>or silver alloy with gold plating (code A) |
| <b>Terminals:</b>           | Brass with silver or gold plating   |

## Environmental Data

|                              |  |
|------------------------------|--|
| <b>Operating Temp Range:</b> | -30°C through +85°C (-22°F through +185°F)   |
| <b>Humidity:</b>             | 90 ~ 95% humidity for 96 hours @ 40°C (104°F)  |
| <b>Vibration:</b>            | 10 ~ 55Hz with peak-to-peak amplitude of 1.5mm traversing the frequency range & returning in 1 minute; 3 right angled directions for 2 hours |
| <b>Shock:</b>                | 50G (490m/s <sup>2</sup> ) acceleration (tested in 6 right angled directions, with 5 shocks in each direction)                               |

## Installation

|                                |   |
|--------------------------------|---|
| <b>Cap Installation Force:</b> | 49.0N (11.0 lbf) for plunger A & 79.4N (17.9 lbf) for plunger B |
|--------------------------------|---|

## PCB Processing

|                   |  |
|-------------------|--|
| <b>Soldering:</b> | Wave Soldering Recommended: See Profile B in Supplement section.<br>Manual Soldering: See Profile B in Supplement section. |
| <b>Cleaning:</b>  | Automated cleaning. See Cleaning specifications in Supplement section.   |

## Standards & Certifications

|                                |  |
|--------------------------------|--|
| <b>Flammability Standards:</b> | UL94V-0 rated bushing/housing & base   |
| <b>UL:</b>                     | <b>File No. E44145 - Recognized only when ordered with marking on switch.</b><br>Add "/U" or "/CUL" before dash in part number to order UL recognized switch.<br>All models recognized at 1A @ 125V AC, 1A @ 30V DC, or 0.4A @ 28V DC. |
| <b>CSA:</b>                    | <b>File No. 023535_0_000 - Certified only when ordered with marking on switch.</b><br>Add "/C" before dash in part number to order CSA certified switch.<br>All models certified at 1A @ 125V AC, 1A @ 30V DC, or 0.4A @ 28V DC.       |

# Distinctive Characteristics

Snap-acting contact mechanism gives short travel, sensitive actuation, light touch, smooth feel, audible feedback, and a longer electrical life.

Single unit construction of the bushing and top of the housing gives protection from cleaning fluids or other liquids.

O-ring surrounding actuator at top of bushing interior prevents liquids from reaching switch mechanism.

Ultrasonic welding of upper and lower housing seals out contaminants and allows automated soldering and cleaning.

Terminals are epoxy sealed to prevent entry of flux, solvents, and other contaminants.

Bracketed models have crimped bracket legs to ensure secure PC mounting and prevent dislodging during automated soldering.

Logic level and power capabilities are available to suit varying applications.

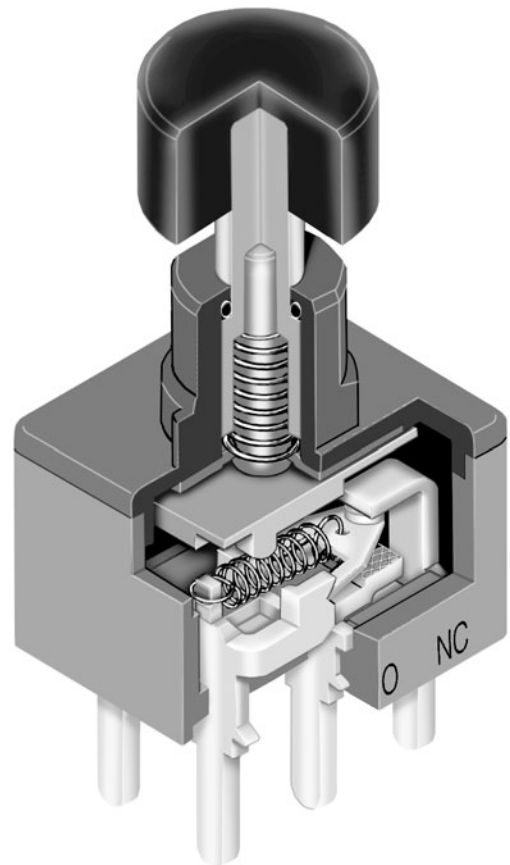

Actual Size

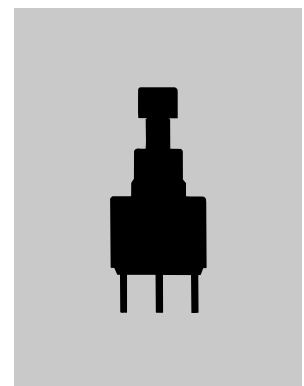

- Toggles
- Rockers
- Pushbuttons**
- Illuminated PB
- Programmable
- Keylocks
- Rotaries
- Slides
- Tactiles
- Tilt
- Touch
- Indicators
- Accessories
- Supplement

### TYPICAL SWITCH ORDERING EXAMPLE

**M2B**

**15**

**A**

**A5**

**G**

**30**

—

**F**

**C**

#### Poles & Circuits

|                 |      |    |      |
|-----------------|------|----|------|
| 15              | SPDT | ON | (ON) |
| 25              | DPDT | ON | (ON) |
| ( ) = Momentary |      |    |      |

#### Plungers

|          |  |
|----------|--|
| <b>A</b> | .282" (7.16mm) Long<br>for cap codes F & H |
| <b>B</b> | .307" (7.8mm) Long<br>for cap codes B & C  |

#### Bushing

|           |                                  |
|-----------|----------------------------------|
| <b>A5</b> | .250" (6.35mm)<br>Double Flatted |
|-----------|----------------------------------|

#### Contact Materials & Ratings

|          |  |
|----------|--|
| <b>W</b> | Silver;<br>Rated 1A @ 125V AC<br>& 1A @ 30V DC                         |
| <b>G</b> | Gold;<br>Rated 0.4VA maximum<br>@ 28V AC/DC maximum                    |
| <b>A</b> | Gold over Silver; Rated<br>1A @ 125V AC & 0.4VA<br>max @ 28V AC/DC max |

#### PC Terminals

|           |   |
|-----------|---|
| <b>03</b> | Straight                                |
| <b>13</b> | Straight with<br>.460" (11.7mm) Bracket |
| <b>30</b> | .150" (3.81mm) Right Angle              |
| <b>40</b> | .150" (3.81mm) Vertical                 |

#### Snap-on Caps

|               |                         |
|---------------|-------------------------|
| For Plunger A |                         |
| <b>F</b>      | .201" (5.1mm) Diameter  |
| <b>H</b>      | .295" (7.5mm) Diameter  |
| For Plunger B |                         |
| <b>B</b>      | .315" (8.0mm) Diameter  |
| <b>C</b>      | .394" (10.0mm) Diameter |

#### Cap Colors

|                               |        |
|-------------------------------|--------|
| <b>A</b>                      | Black  |
| <b>B</b>                      | White  |
| <b>C</b>                      | Red    |
| * <b>E</b>                    | Yellow |
| * <b>F</b>                    | Green  |
| * <b>G</b>                    | Blue   |
| * <b>H</b>                    | Gray   |
| * For cap codes<br>B & C only |        |

#### IMPORTANT:



Switches are supplied without UL, cULus & CSA marking unless specified.  
**UL, cULus & CSA recognized only when ordered with marking on the switch.**  
Specific models, ratings, & ordering instructions are noted on General Specifications page.

#### DESCRIPTION FOR TYPICAL ORDERING EXAMPLE

**M2B15AA5G30-FC**

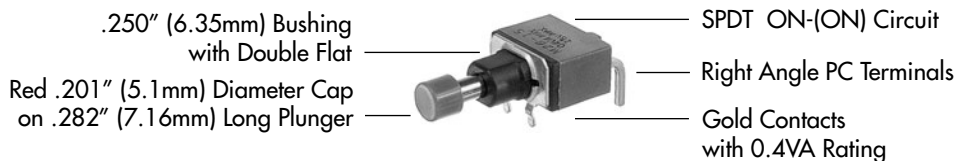

## POLES & CIRCUITS

| Pole | Model | Plunger Position<br>( ) = Momentary |      | Connected Terminals |         | Throw & Schematics                                     |
|------|-------|-------------------------------------|------|---------------------|---------|--|
|      |       | Normal                              | Down | Normal              | Down    |  |
|      |       |                                     |      |                     |         | Note: Terminal numbers are not actually on the switch. |
| SP   | M2B15 | ON                                  | (ON) | 1-3                 | 1-2     | SPDT   |
| DP   | M2B25 | ON                                  | (ON) | 1-3 4-6             | 1-2 4-5 | DPDT   |

## PLUNGERS

**A** .282" (7.16mm) Long

For cap codes F & H

Material:  
Chrome over brass

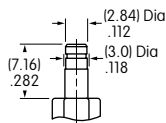

**B** .307" (7.8mm) Long

For cap codes B & C

Material:  
Chrome over brass

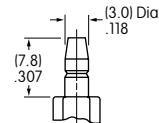

## BUSHING

**A5** .250" (6.35mm) Double Flatted

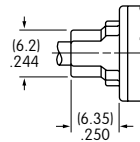
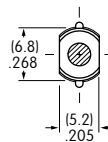

## CONTACT MATERIALS & RATINGS

**W** Silver over Silver      Power Level      1A @ 125V AC & 1A @ 30V DC

**G** Gold over Brass or Copper      Logic Level      0.4VA maximum @ 28V AC/DC maximum

Complete explanation of operating range in Supplement section.

**A** Gold over Silver      Power Level or Logic Level      1A @ 125V AC or 0.4VA maximum @ 28V AC/DC maximum

Note: This dual rated option is suitable when two or more identical switches are used in logic and in power circuits within the same application. See Supplement section for complete explanation of dual rating and operating range.

## PC TERMINALS

**03** Straight

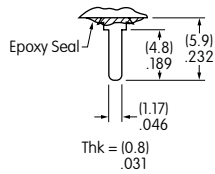

**13** Straight with .460" (11.7mm) Bracket

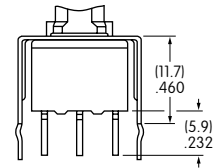

**30** .150" (3.81mm) Right Angle

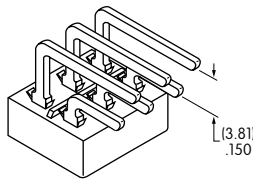

**40** .150" (3.81mm) Vertical

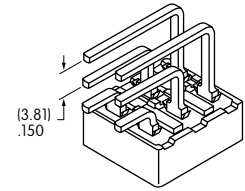

## SNAP-ON CAPS

### For Plunger Type A

**F** AT475  
.201" (5.1mm) Diameter

Material: Polyamide

Colors Available:  
A, B, C

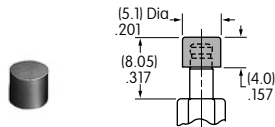

**H** AT496  
.295" (7.5mm) Diameter

Material: Polyamide

Colors Available:  
A, B, C

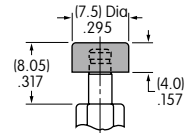

### For Plunger Type B

**B** AT443  
.315" (8.0mm) Diameter

Material: Polycarbonate

Colors Available:  
A, B, C, E, F, G, H

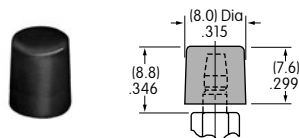

**C** AT442  
.394" (10.0mm) Diameter

Material: Polycarbonate

Colors Available:  
A, B, C, E, F, G, H

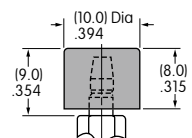

Cap Colors  
Codes:

**A** Black   **B** White   **C** Red   **E** Yellow   **F** Green   **G** Blue   **H** Gray

TYPICAL SWITCH DIMENSIONS

Single Pole

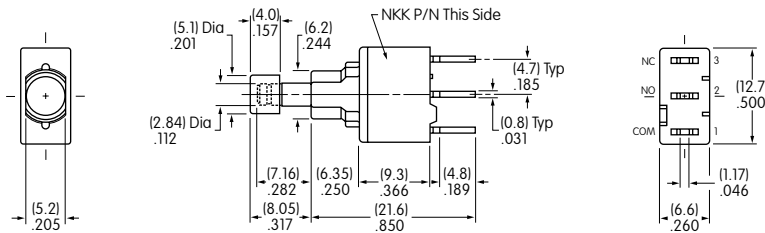

Straight PC

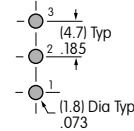

M2B15AA5G03-FC

Double Pole

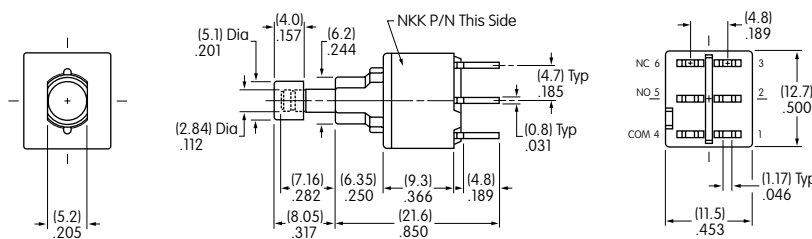

Straight PC

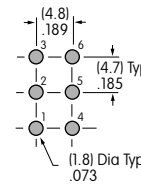

M2B25AA5G03-FC

Single & Double Pole

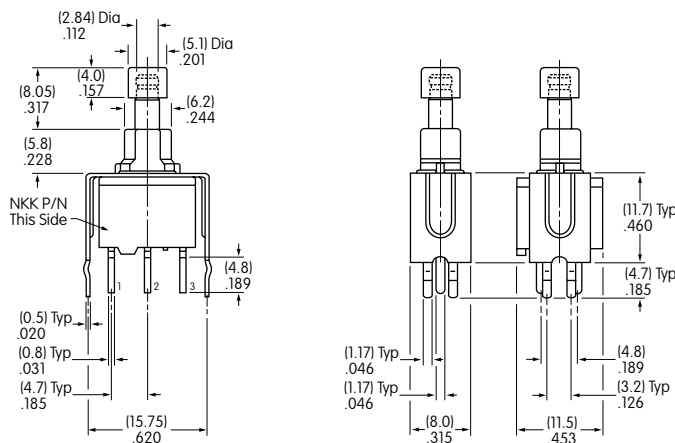

Straight PC • Bracket

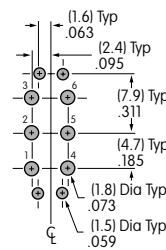
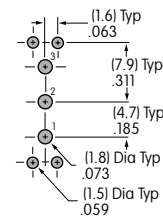

M2B15AA5G13-FC

## TYPICAL SWITCH DIMENSIONS

### Right Angle PC

### Single Pole

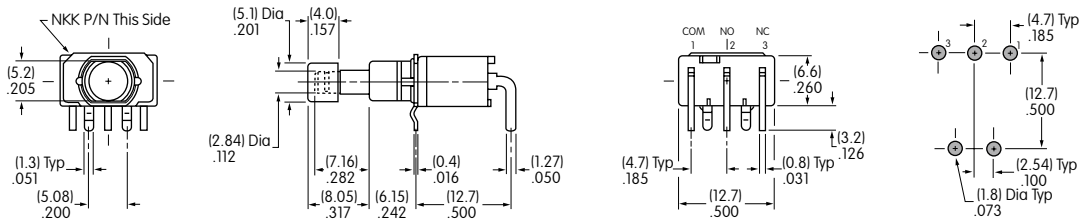

M2B15AA5G30-FC

### Right Angle PC

### Double Pole

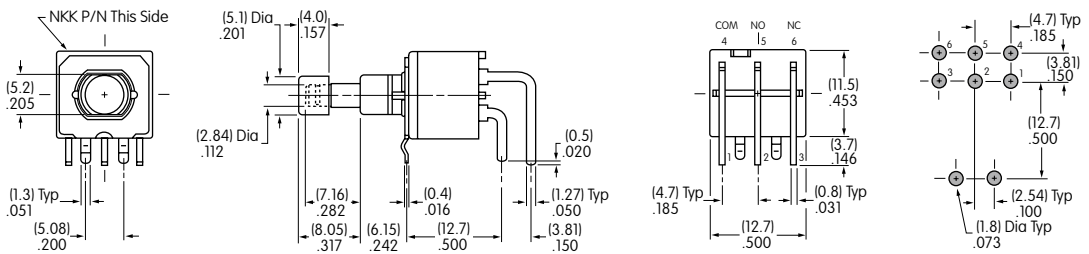

M2B25AA5G30-FC

### Vertical PC

### Single Pole

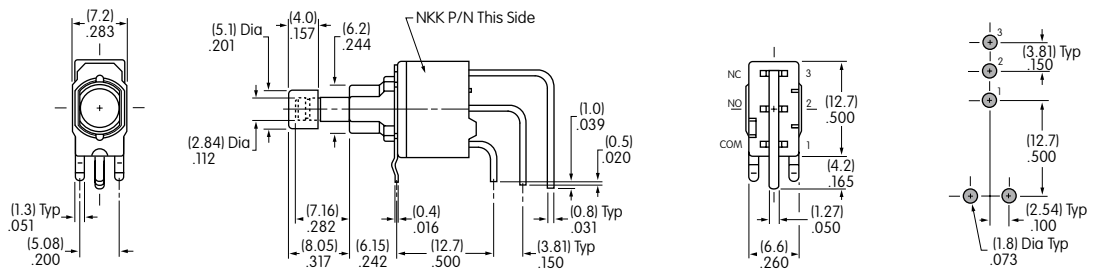

M2B15AA5G40-FC

### Vertical PC

### Double Pole

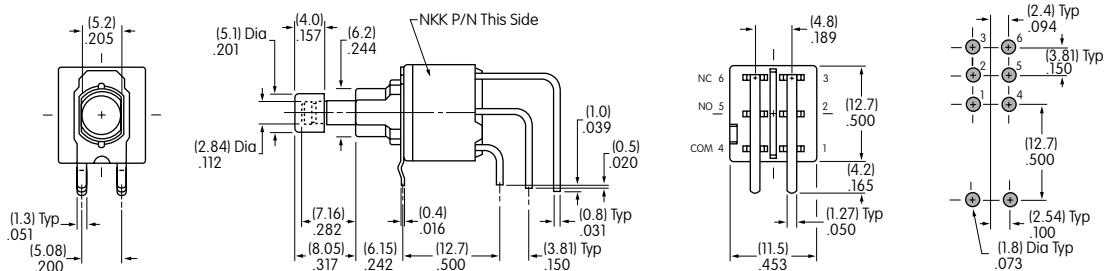

M2B25AA5G40-FC



Компания «ЭлектроПласт» предлагает заключение долгосрочных отношений при поставках импортных электронных компонентов на взаимовыгодных условиях!

Наши преимущества:

- Оперативные поставки широкого спектра электронных компонентов отечественного и импортного производства напрямую от производителей и с крупнейших мировых складов;
- Поставка более 17-ти миллионов наименований электронных компонентов;
- Поставка сложных, дефицитных, либо снятых с производства позиций;
- Оперативные сроки поставки под заказ (от 5 рабочих дней);
- Экспресс доставка в любую точку России;
- Техническая поддержка проекта, помощь в подборе аналогов, поставка прототипов;
- Система менеджмента качества сертифицирована по Международному стандарту ISO 9001;
- Лицензия ФСБ на осуществление работ с использованием сведений, составляющих государственную тайну;
- Поставка специализированных компонентов (Xilinx, Altera, Analog Devices, Intersil, Interpoint, Microsemi, Aeroflex, Peregrine, Syfer, Eurofarad, Texas Instrument, Miteq, Cobham, E2V, MA-COM, Hittite, Mini-Circuits, General Dynamics и др.);

Помимо этого, одним из направлений компании «ЭлектроПласт» является направление «Источники питания». Мы предлагаем Вам помощь Конструкторского отдела:

- Подбор оптимального решения, техническое обоснование при выборе компонента;
- Подбор аналогов;
- Консультации по применению компонента;
- Поставка образцов и прототипов;
- Техническая поддержка проекта;
- Защита от снятия компонента с производства.



#### Как с нами связаться

**Телефон:** 8 (812) 309 58 32 (многоканальный)

**Факс:** 8 (812) 320-02-42

**Электронная почта:** [org@eplast1.ru](mailto:org@eplast1.ru)

**Адрес:** 198099, г. Санкт-Петербург, ул. Калинина, дом 2, корпус 4, литера А.