



Package Style: QFN, 16-Pin, 0.9mm x 3mm x 3mm



**Features**

- Patented Circuit Architecture
- Broadband 50MHz to 6000MHz Frequency Range
- 30dB Attenuation Range
- +50dBm IIP3 Typical
- +80dBm IIP2 Typical
- High 1dB Compression Point >+30dBm
- Low Supply Current 1mA Typical
- 5V Power Supply
- Linear in dB Control Characteristic
- Internal Temperature Compensation
- Class 1C ESD (1000V)
- 3.3V Version Available (RFSA2023)
- Complete Solution in a Small 3mm x 3mm, QFN Package

**Applications**

- Cellular, 3G Infrastructure
- WiBro, WiMax, LTE
- Microwave Radio
- High Linearity Power Control

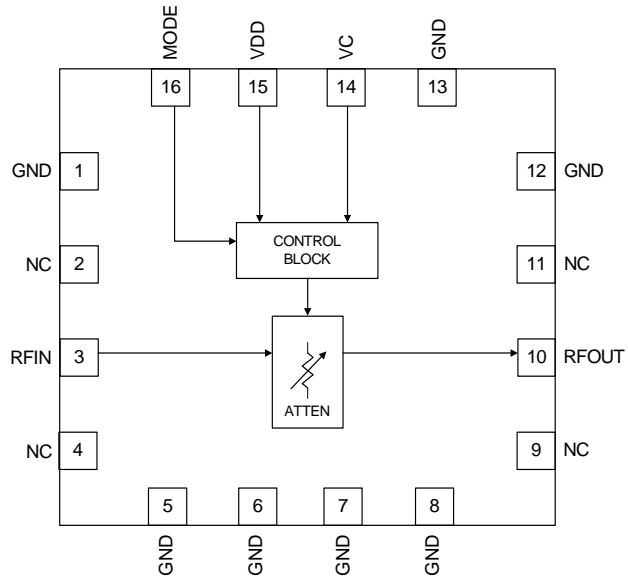

Functional Block Diagram

**Product Description**

RFMD's RFSA2013 is a fully monolithic analog voltage controlled attenuator (VCA) featuring exceptional linearity over a typical temperature compensated 30dB gain control range. It incorporates a revolutionary new circuit architecture to solve a long standing industry problem: high IP3, high attenuation range, low DC current, broad bandwidth and temperature compensated linear in dB control voltage characteristic. This voltage controlled attenuator is controlled by a single positive control voltage with on chip DC conditioning circuitry. The slope of the control voltage versus gain is selectable. The RFSA2013 draws a very low 1mA current and is packaged in a small 3mm x 3mm QFN. This attenuator is matched to 50Ω over its rated control range and frequency with no external matching components required. Typical VCA's in this performance category have poor inherent attenuation versus temperature and poor nonlinear attenuation versus control voltage characteristics. To correct these shortcomings, other VCA's require extensive off chip analog support circuitry that consume valuable PCB area and additional DC power. This game changing product incorporates the complete solution in a small 3mm x 3mm QFN package that reduces the footprint by 20X in area and reduces the DC power by 10X over conventional PIN diode approaches.

**Ordering Information**

- RFSA2013SR 7" Sample reel with 100 pieces
- RFSA2013SQ Sample bag with 25 pieces
- RFSA2013TR7 7" Reel with 2500 pieces
- RFSA2013PCK-410 50MHz to 6000MHz PCBA with 5-piece sample bag

**Optimum Technology Matching® Applied**

- |                                      |                                      |   |                                    |
|--------------------------------------|--------------------------------------|---|------------------------------------|
| <input type="checkbox"/> GaAs HBT    | <input type="checkbox"/> SiGe BiCMOS | <input type="checkbox"/> GaAs pHEMT         | <input type="checkbox"/> GaN HEMT  |
| <input type="checkbox"/> GaAs MESFET | <input type="checkbox"/> Si BiCMOS   | <input checked="" type="checkbox"/> Si CMOS | <input type="checkbox"/> BiFET HBT |
| <input type="checkbox"/> InGaP HBT   | <input type="checkbox"/> SiGe HBT    | <input type="checkbox"/> Si BJT             |                                    |

RF MICRO DEVICES®, RFMD®, Optimum Technology Matching®, Enabling Wireless Connectivity™, PowerStar®, POLARIS™ TOTAL RADIO™ and UltimateBlue™ are trademarks of RFMD, LLC. BLUETOOTH is a trademark owned by Bluetooth SIG, Inc., U.S.A. and licensed for use by RFMD. All other trade names, trademarks and registered trademarks are the property of their respective owners. ©2012, RF Micro Devices, Inc.

## Absolute Maximum Ratings

Parameter	Rating	Unit
Supply Voltage ( $V_{DD}$ )	-0.5 to +6	V
Control Voltage ( $V_C$ )	-0.5 to +6	V
Mode Pin Voltage (MODE)	-0.5 to +6	V
RF Input Power	+30	dBm
Storage Temperature	-65 to +150	°C
Junction Temperature	+125	°C
ESD Rating Human Body Model (HBM)	1000	V



**Caution!** ESD sensitive device.

Exceeding any one or a combination of the Absolute Maximum Rating conditions may cause permanent damage to the device. Extended application of Absolute Maximum Rating conditions to the device may reduce device reliability. Specified typical performance or functional operation of the device under Absolute Maximum Rating conditions is not implied.

The information in this publication is believed to be accurate and reliable. However, no responsibility is assumed by RF Micro Devices, Inc. ("RFMD") for its use, nor for any infringement of patents, or other rights of third parties, resulting from its use. No license is granted by implication or otherwise under any patent or patent rights of RFMD. RFMD reserves the right to change component circuitry, recommended application circuitry and specifications at any time without prior notice.



RFMD Green: RoHS compliant per EU Directive 2002/95/EC, halogen free per IEC 61249-2-21, < 1000ppm each of antimony trioxide in polymeric materials and red phosphorus as a flame retardant, and <2% antimony in solder.

Parameter	Specification			Unit	Condition
	Min.	Typ.	Max.		
<b>General</b>					
Supply Voltage	4.75	5	5.25	V	
Supply Current		1		mA	
Operating Temperature (RF Input Power Handling Derates Above 85 °C)	-40		+105	°C	
Thermal Resistance		45		°C/W	RF input must be RFIN pin
RF Input Power at 85 °C			27	dBm	RF input must be RFIN pin
<b>RF Performance</b>					
Frequency Range	50		6000	MHz	
Minimum Insertion Loss		2.6	3.5	dB	
Gain Control Range	30	33.2		dB	DC to 4GHz
Gain versus Temperature		1.7		dB	Peak to peak gain variation over temperature for fixed control voltage
Return Loss		15		dB	
Relative Phase		16.2		Deg	Insertion phase at 15dB attenuation relative to minimum insertion loss
Input 1dB Compression Point		30		dBm	
Input IP3	45	50		dBm	$PIN + (IM3_{dBc}/2)$
Input IP2		80		dBm	$PIN + IM2_{dBc}$ , IM2 is F1+F2
Input IH2		85		dBm	$PIN + H2_{dBc}$ , H2 is second harmonic
Input IH3		55		dBm	$PIN + (H3_{dBc}/2)$ , H3 is third harmonic
<b>Control</b>					
Voltage Control Range, Positive Attenuation Slope	0.5		4.5	V	4.5V control voltage is lowest insertion loss, MODE pin high
Voltage Control Range, Negative Attenuation Slope	0		3.3	V	0V control voltage is lowest insertion loss, MODE pin low
Voltage Control Pin Current (MODE High)		37		μA	VC Pin at 5V
Voltage Control Pin Current (MODE Low)		24		μA	VC Pin at 3.3V
MODE Pin Logic Low			0.4	V	
MODE Pin Logic High	1			V	
Settling Time		15		μsec	1dB attenuation change settling within 0.1dB

Note: Typical performance at nominal conditions unless otherwise noted: Supply voltage = 5.0V, Operating temperature = 25 °C, RF Frequency 2GHz

**Measured Positive Attenuation Slope Performance**

Data includes PCB and connector losses

**Insertion Loss versus Voltage Control**  
RF 2GHz, V<sub>DD</sub>=5V

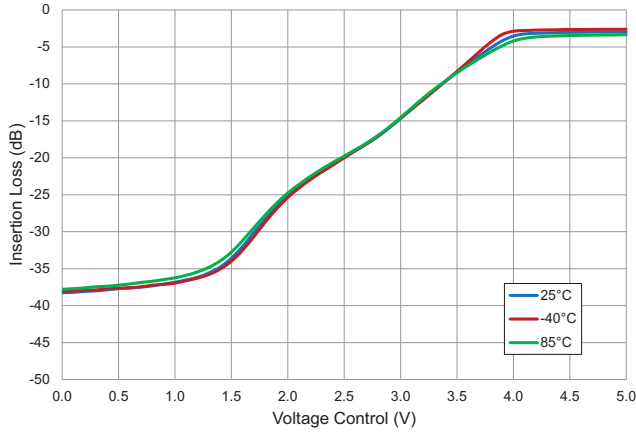

**Insertion Loss versus Frequency**  
V<sub>DD</sub>=5V, Temp=+25°C

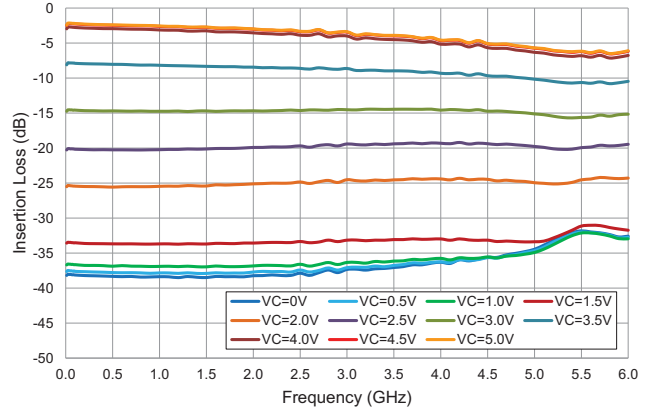

**Input Return Loss versus Frequency**  
V<sub>DD</sub>=5V, Temp=+25°C

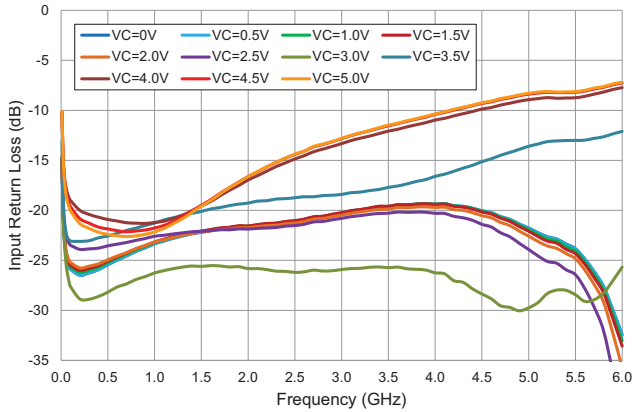

**Output Return Loss versus Frequency**  
V<sub>DD</sub>=5V, Temp=+25°C

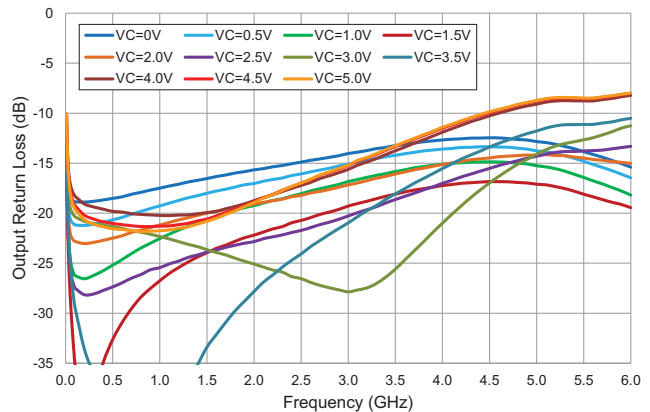

**Input Return Loss versus Voltage Control**  
RF 2GHz, V<sub>DD</sub>=5V

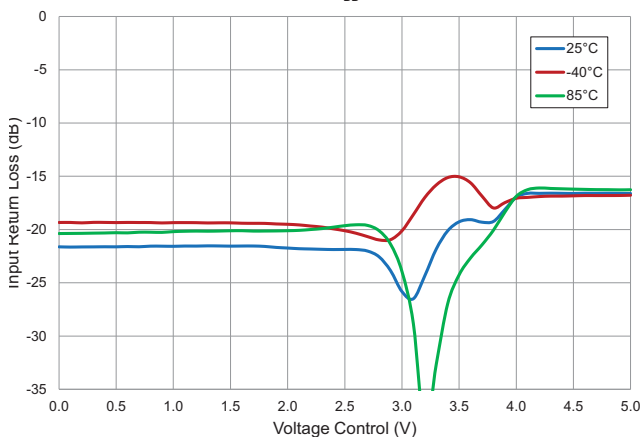

**Output Return Loss versus Voltage Control**  
RF 2GHz, V<sub>DD</sub>=5V

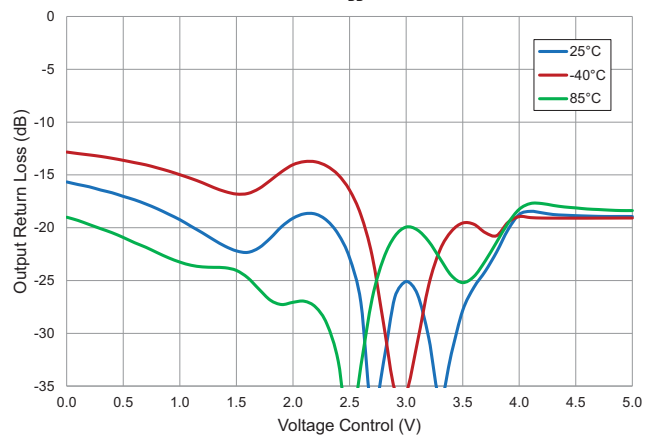

## Measured Positive Attenuation Slope Performance

Data includes PCB and connector losses

**Input IP3 versus Attenuation**  
RF 2GHz,  $V_{DD}=5V$ ,  $P_{in}=+20dBm/Tone$

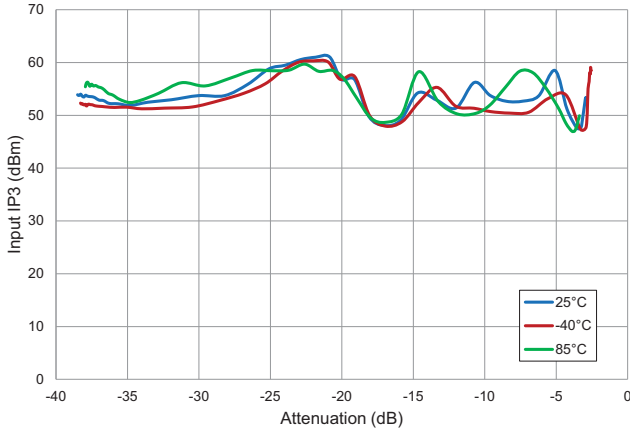

**Input IP3 versus Voltage Control**  
RF 2GHz,  $V_{DD}=5V$ ,  $P_{in}=+20dBm/Tone$

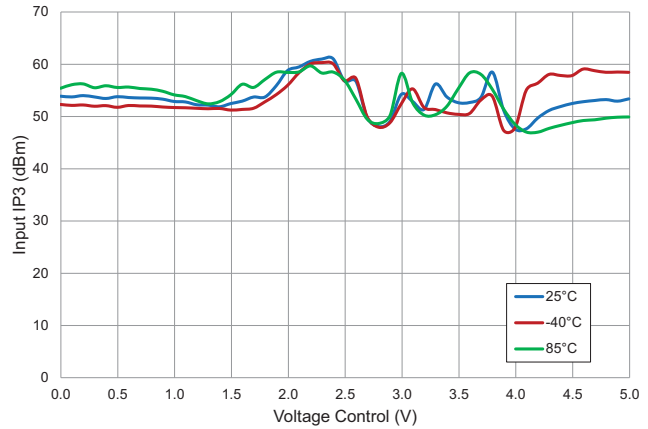

**Input IP3 versus Attenuation**  
 $V_{DD}=5V$ ,  $P_{in}=+20dBm/Tone$ , Temp= $+25^{\circ}C$

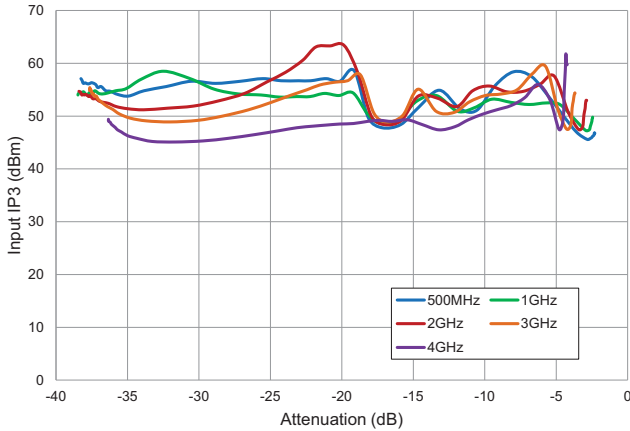

**Input IP3 versus Voltage Control**  
 $V_{DD}=5V$ ,  $P_{in}=+20dBm/Tone$ , Temp= $+25^{\circ}C$

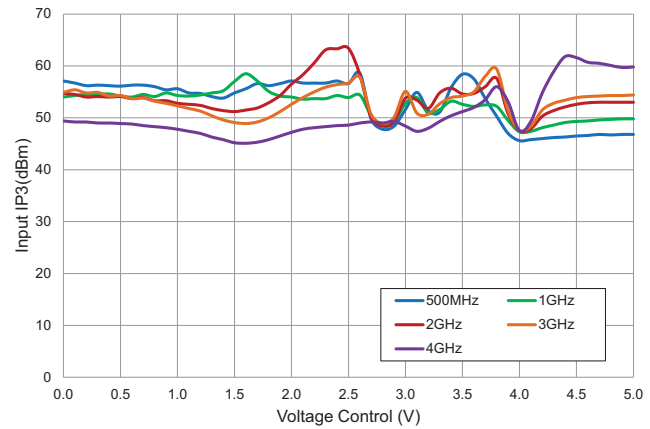

**Input IP2 versus Attenuation**  
RF 2GHz,  $V_{DD}=5V$ ,  $P_{in}=+20dBm/Tone$

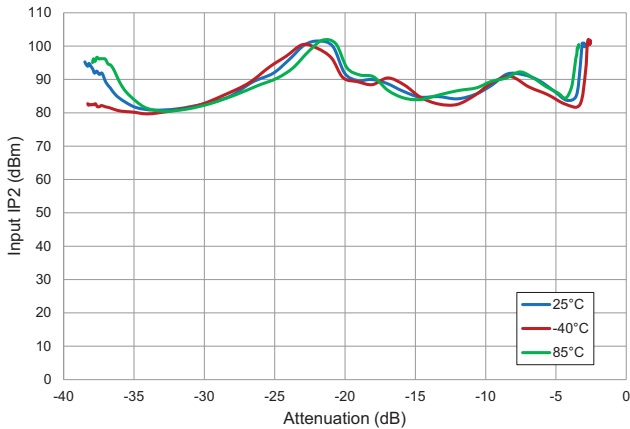

**Input IP2 versus Voltage Control**  
RF 2GHz,  $V_{DD}=5V$ ,  $P_{in}=+20dBm/Tone$

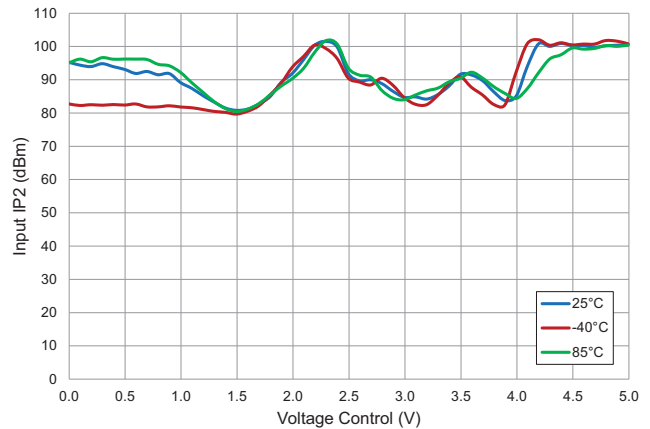

**Measured Positive Attenuation Slope Performance**

Data includes PCB and connector losses

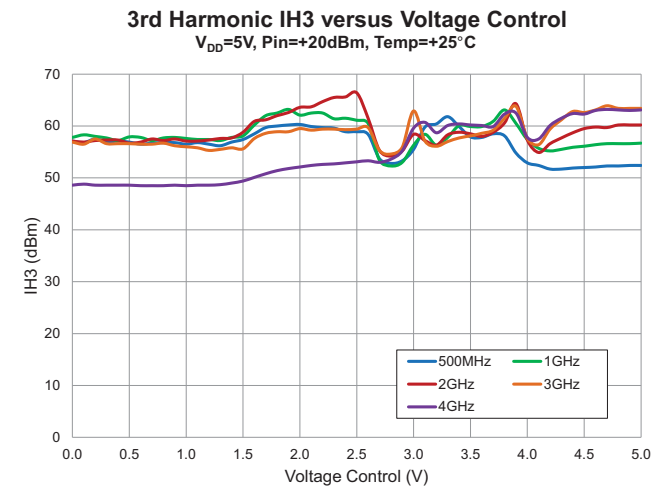
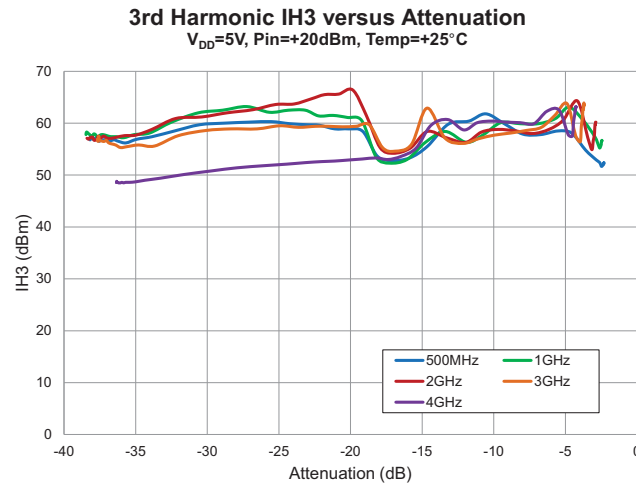
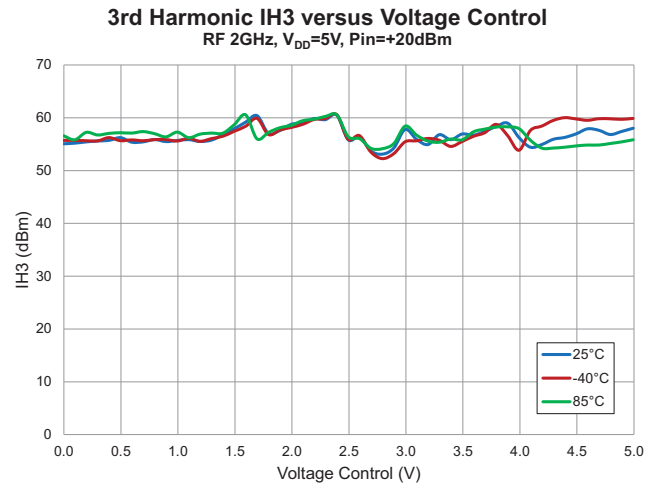
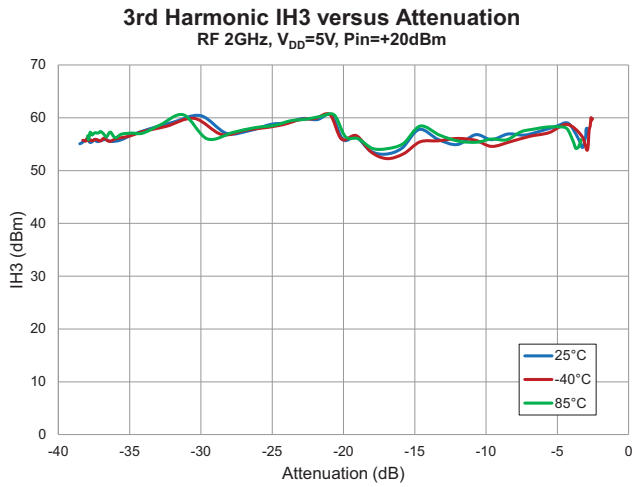
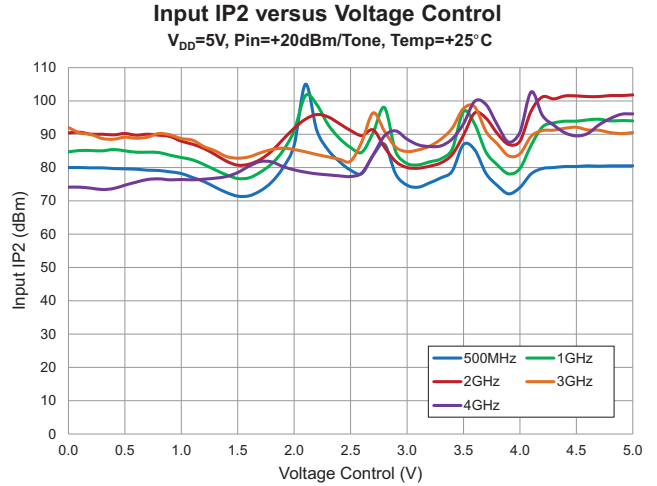
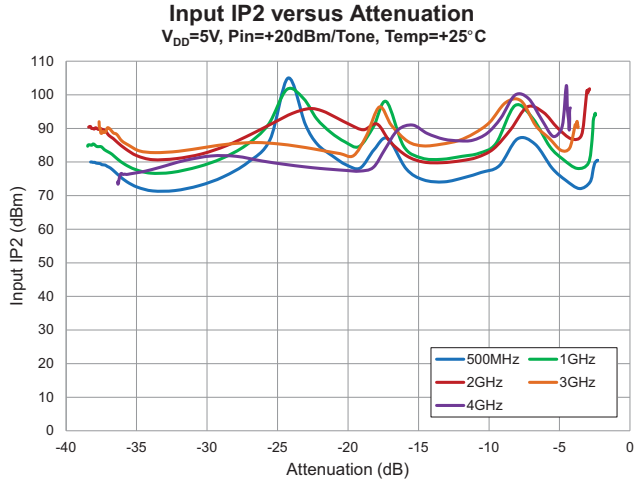

## Measured Positive Attenuation Slope Performance

Data includes PCB and connector losses

**2nd Harmonic IH2 versus Attenuation**  
RF 2GHz,  $V_{DD}=5V$ ,  $P_{in}=+20dBm$

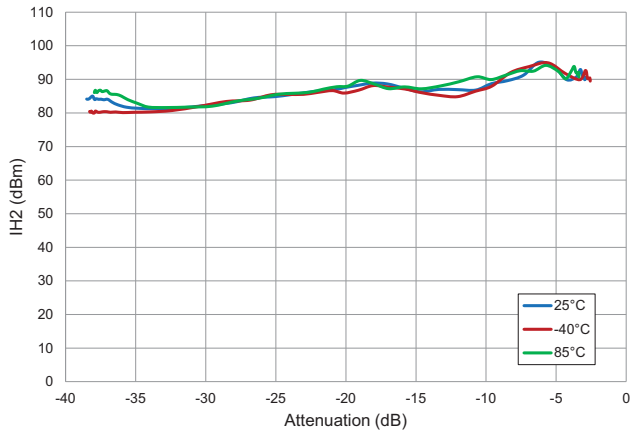

**2nd Harmonic IH2 versus Voltage Control**  
RF 2GHz,  $V_{DD}=5V$ ,  $P_{in}=+20dBm$

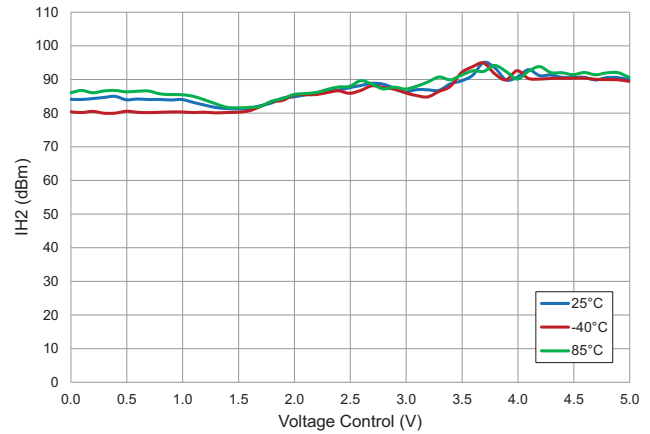

**2nd Harmonic IH2 versus Attenuation**  
 $V_{DD}=5V$ ,  $P_{in}=+20dBm$ , Temp= $+25^{\circ}C$

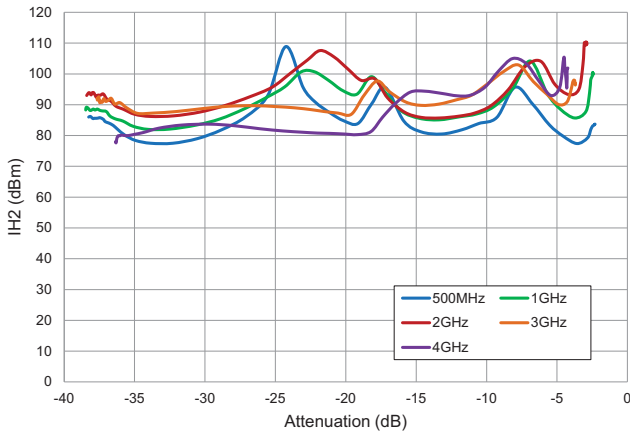

**2nd Harmonic IH2 versus Voltage Control**  
 $V_{DD}=5V$ ,  $P_{in}=+20dBm$ , Temp= $+25^{\circ}C$

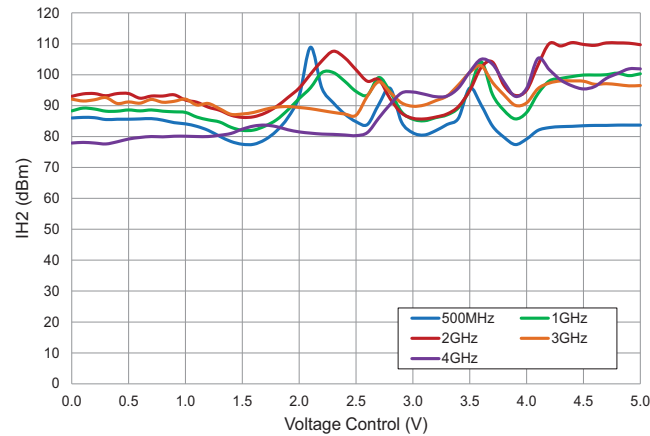

**Measured Positive Attenuation Slope Performance**

Data includes PCB and connector losses

**Relative Insertion Phase versus Voltage Control**  
 $V_{DD}=5V$ , Temp= $+25^{\circ}C$

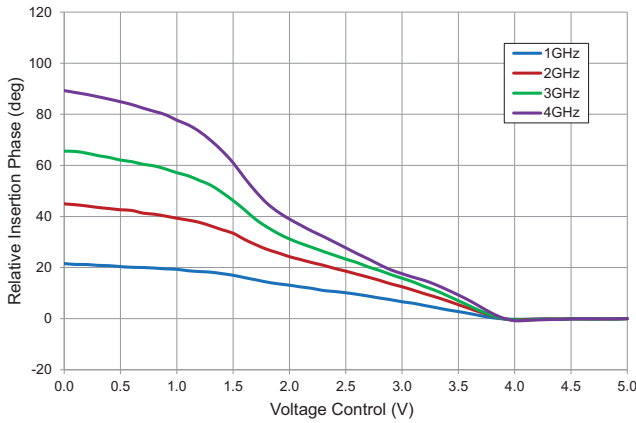

**Relative Insertion Phase versus Insertion Loss**  
 $V_{DD}=5V$ , Temp= $+25^{\circ}C$

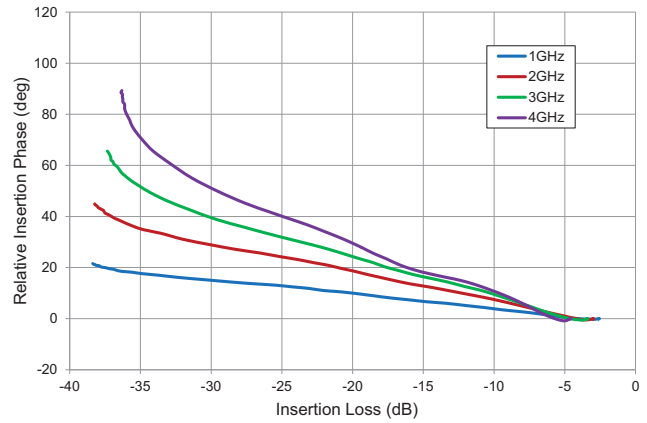

**Settling Time versus Insertion Loss**  
 1dB Steps, RF 2GHz,  $V_{DD}=5V$

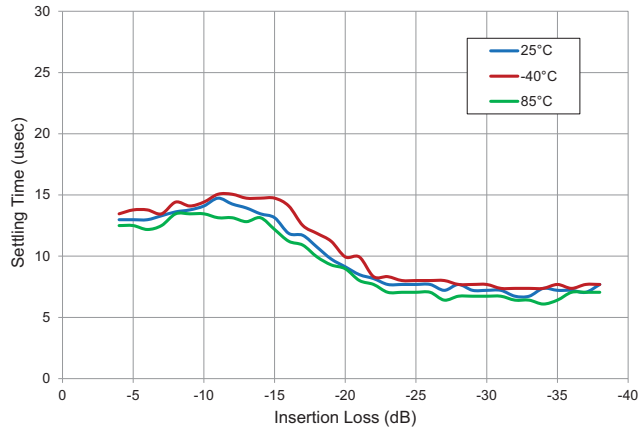

**Insertion Loss Relative to  $+25^{\circ}C$**   
 RF 2GHz,  $V_{DD}=5V$

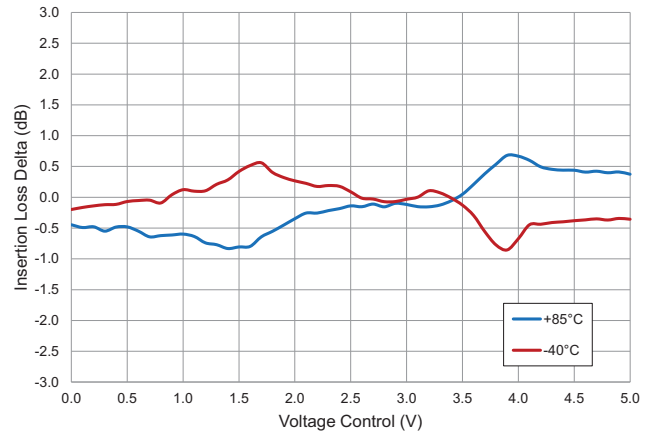

## Measured Negative Attenuation Slope Performance

Data includes PCB and connector losses

**Insertion Loss versus Voltage Control**  
RF 2GHz,  $V_{DD}=5V$

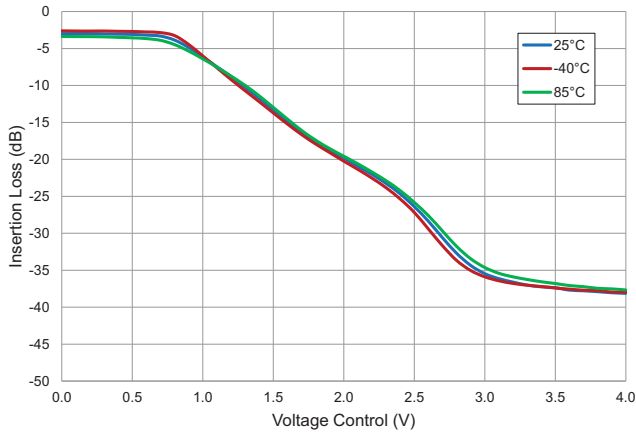

**Insertion Loss versus Frequency**  
 $V_{DD}=5V$ , Temp=+25°C

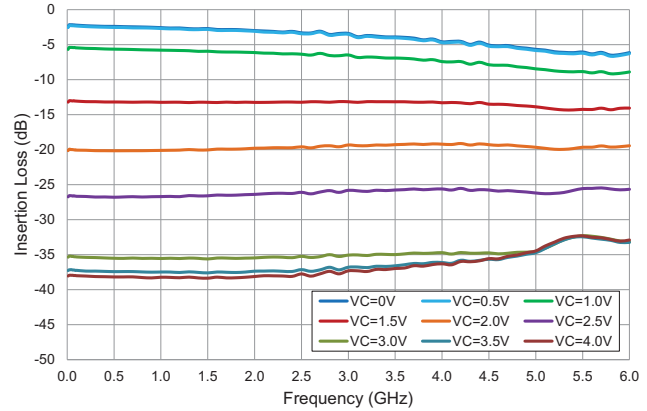

**Input Return Loss versus Frequency**  
RF 2GHz,  $V_{DD}=5V$ , Temp=+25°C

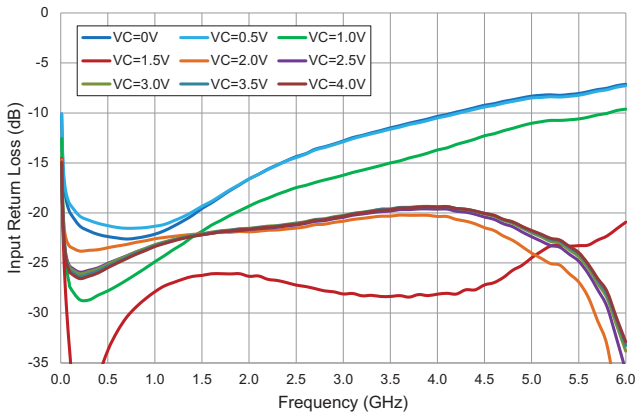

**Output Return Loss versus Frequency**  
RF 2GHz,  $V_{DD}=5V$ , Temp=+25°C

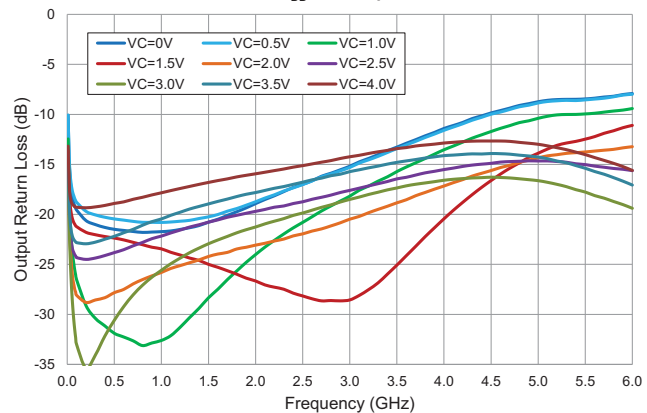

**Input Return Loss versus Voltage Control**  
RF 2GHz,  $V_{DD}=5V$

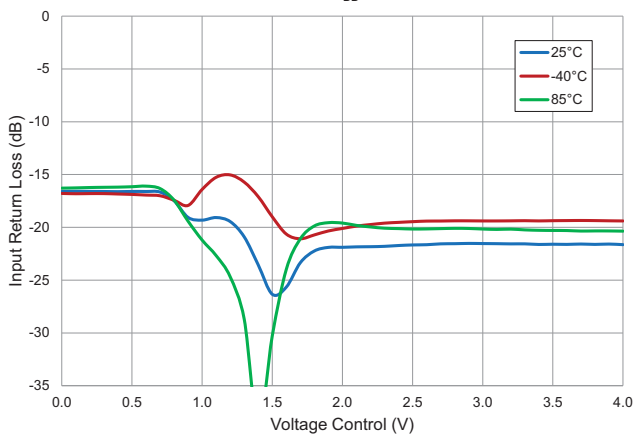

**Output Return Loss versus Voltage Control**  
RF 2GHz,  $V_{DD}=5V$

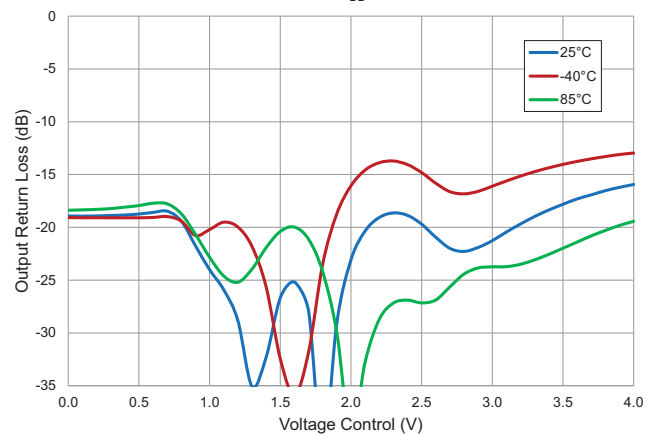



**Measured Negative Attenuation Slope Performance**

Data includes PCB and connector losses

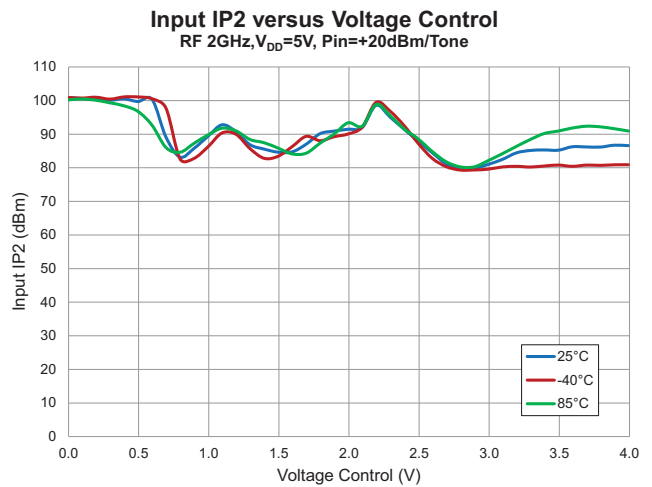
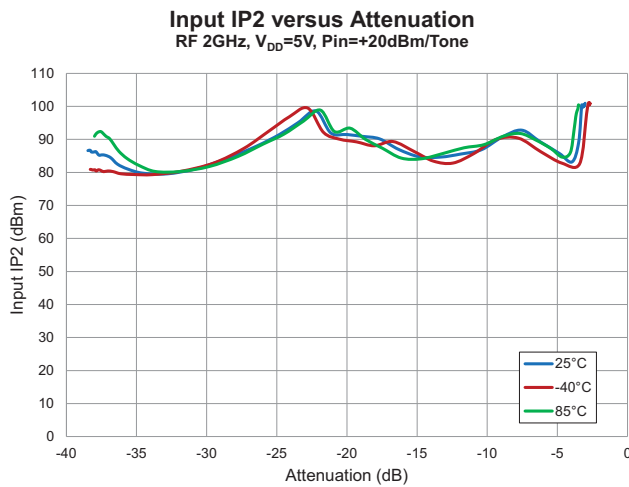
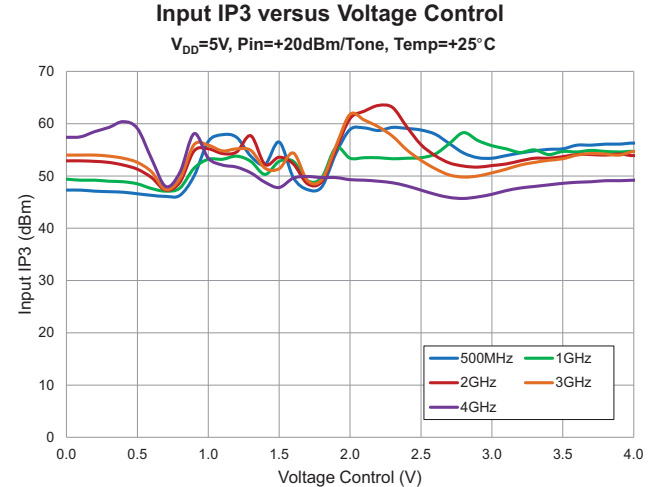
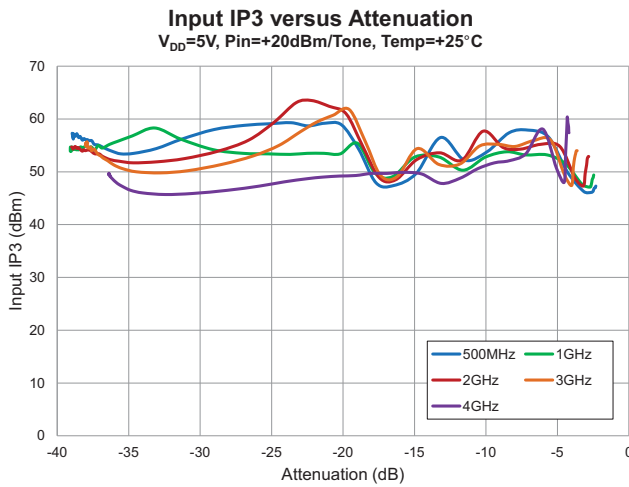
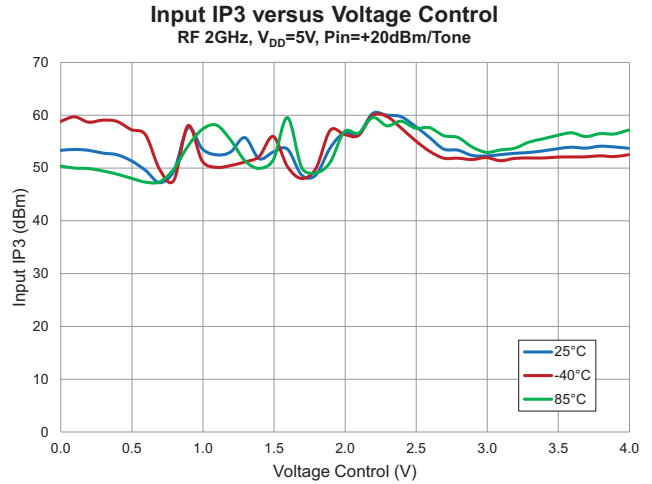
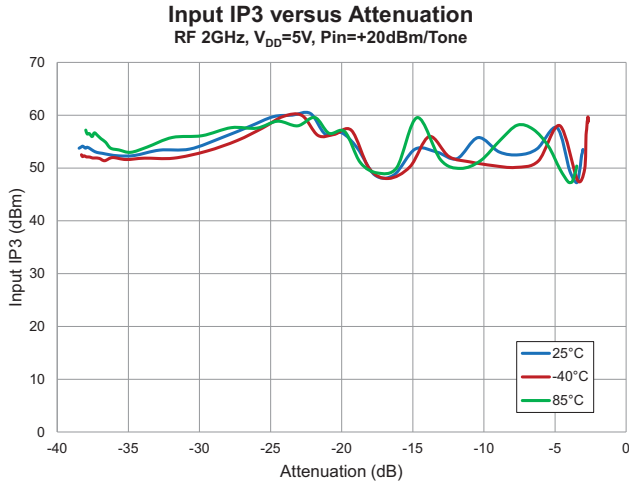

## Measured Negative Attenuation Slope Performance

Data includes PCB and connector losses

**Input IP2 versus Attenuation**  
 $V_{DD}=5V$ ,  $P_{in}=+20dBm/Tone$ ,  $Temp=+25^{\circ}C$

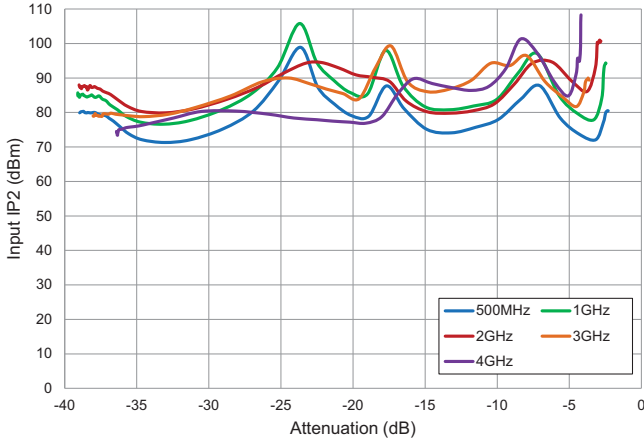

**Input IP2 versus Voltage Control**  
 $V_{DD}=5V$ ,  $P_{in}=+20dBm/Tone$ ,  $Temp=+25^{\circ}C$

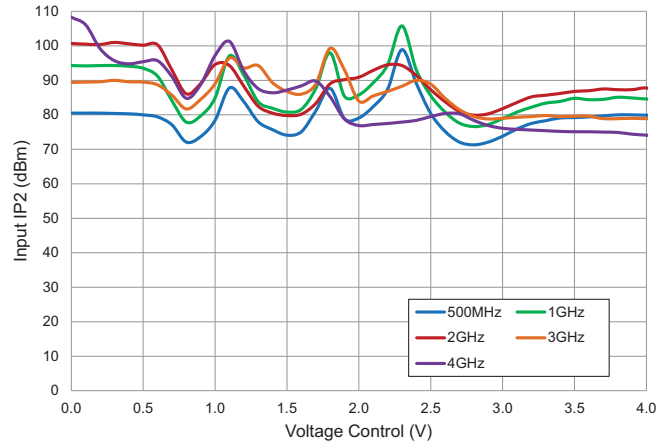

**3rd Harmonic IH3 versus Attenuation**  
 RF 2GHz,  $V_{DD}=5V$ ,  $P_{in}=+20dBm$

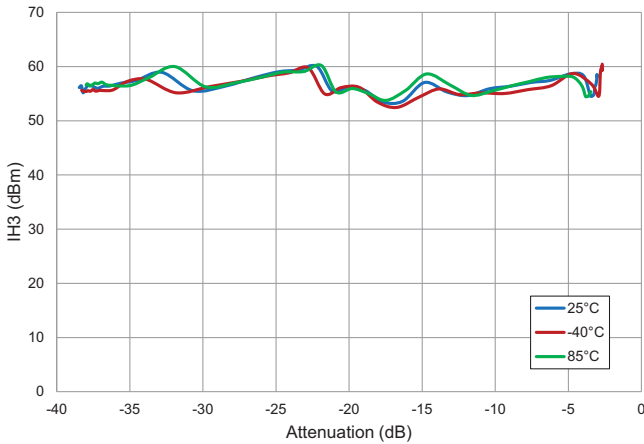

**3rd Harmonic IH3 versus Voltage Control**  
 RF 2GHz,  $V_{DD}=5V$ ,  $P_{in}=+20dBm$

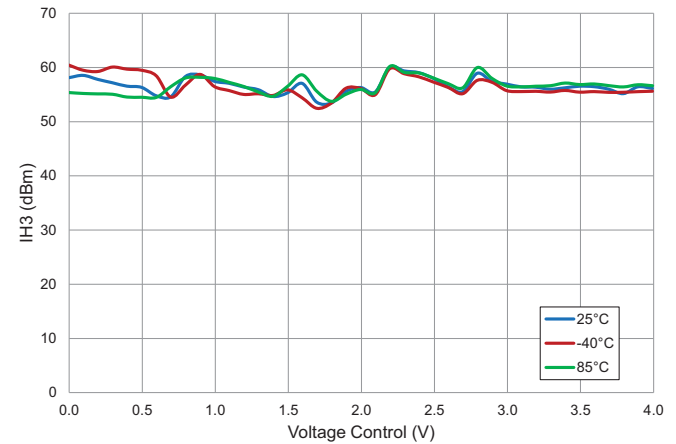

**3rd Harmonic IH3 versus Attenuation**  
 $V_{DD}=5V$ ,  $P_{in}=+20dBm$ ,  $Temp=+25^{\circ}C$

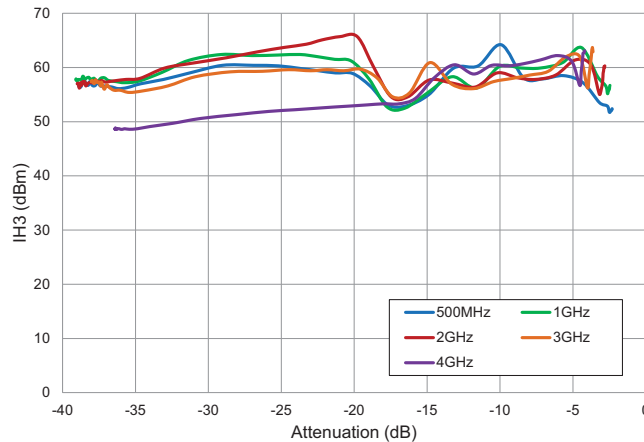

**3rd Harmonic IH3 versus Voltage Control**  
 $V_{DD}=5V$ ,  $P_{in}=+20dBm$ ,  $Temp=+25^{\circ}C$

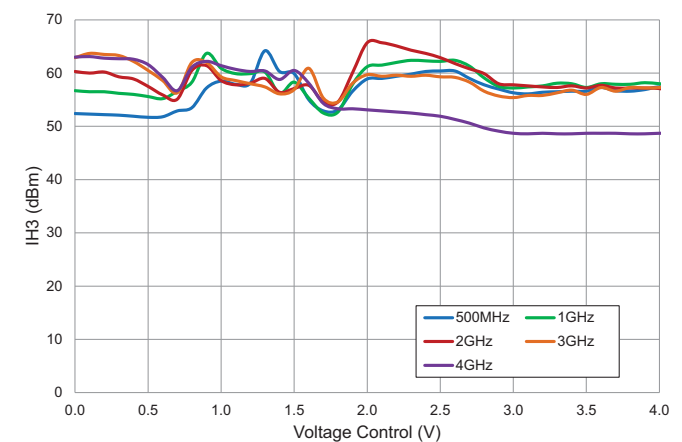

**Measured Negative Attenuation Slope Performance**

Data includes PCB and connector losses

**2nd Harmonic IH2 versus Attenuation**  
RF 2GHz, V<sub>DD</sub>=5V, Pin=+20dBm

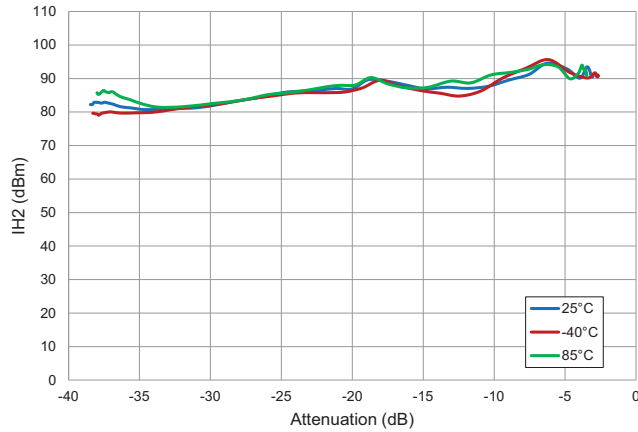

**2nd Harmonic IH2 versus Voltage Control**  
RF 2GHz, V<sub>DD</sub>=5V, Pin=+20dBm

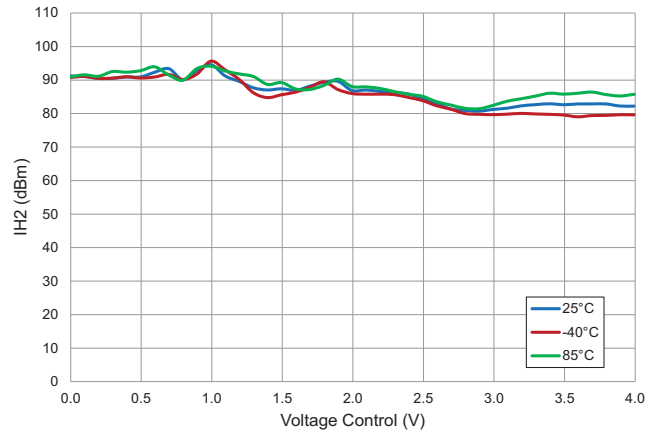

**2nd Harmonic IH2 versus Attenuation**  
V<sub>DD</sub>=5V, Pin=+20dBm, Temp=+25°C

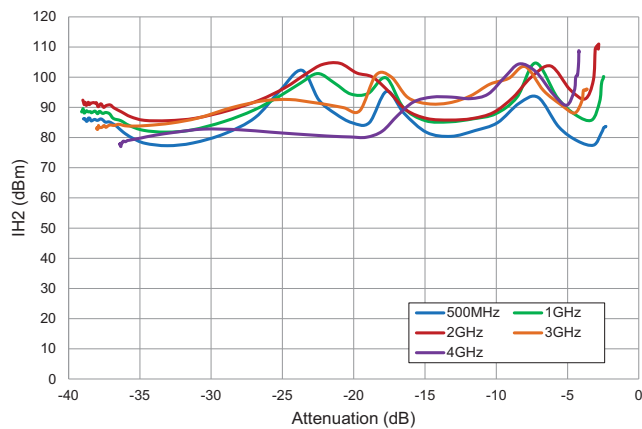

**2nd Harmonic IH2 versus Voltage Control**  
V<sub>DD</sub>=5V, Pin=+20dBm, Temp=+25°C

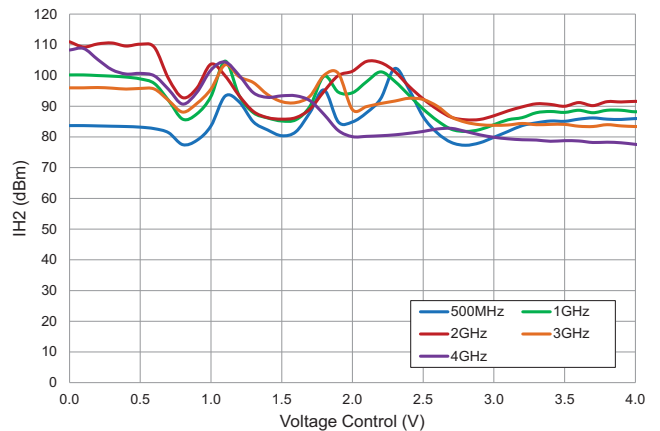

## Measured Negative Attenuation Slope Performance

Data includes PCB and connector losses

**Relative Insertion Phase versus Voltage Control**  
RF 2GHz,  $V_{DD}=5V$ , Temp= $+25^{\circ}C$

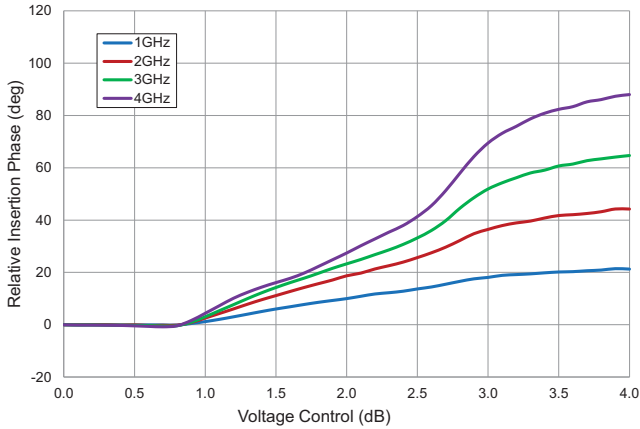

**Relative Insertion Phase versus Insertion Loss**  
RF 2GHz,  $V_{DD}=5V$ , Temp= $+25^{\circ}C$

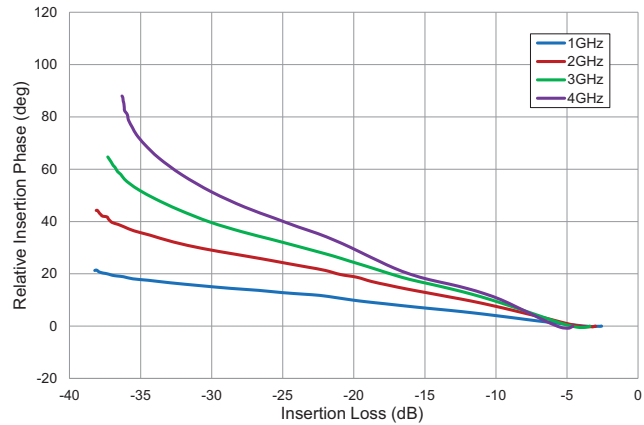

**Insertion Loss Relative to  $+25^{\circ}C$**   
RF 2GHz,  $V_{DD}=5V$

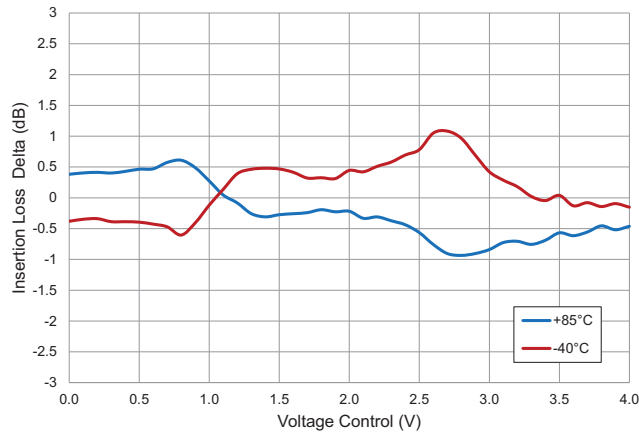

**Voltage Control Pin Current Performance**

Data includes PCB and connector losses

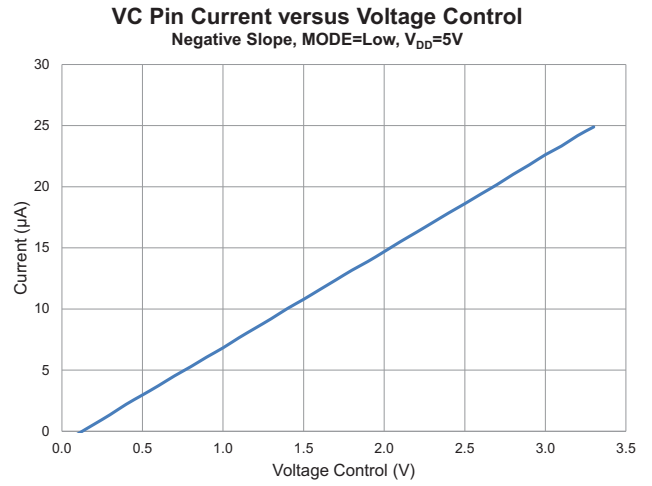
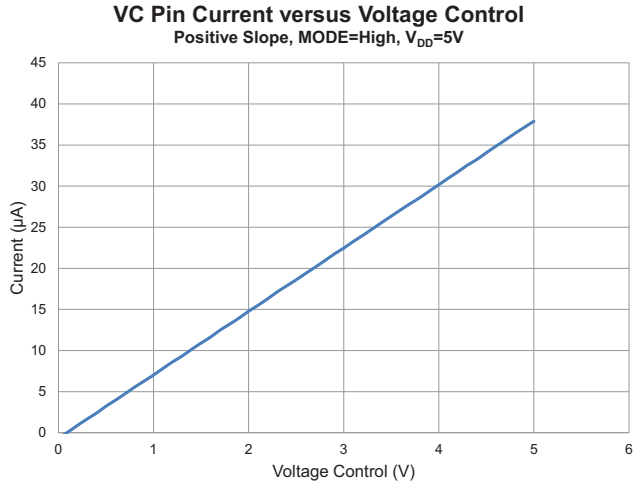

## Pin Names and Descriptions

Pin	Name	Description
1	GND	Ground Pin
2	NC	No Connection. Do Not Connect to PC Board Ground Plane.
3	RFIN	RF Input. Use External DC Block. RF input must be this pin to insure linearity and thermal resistance specifications.
4	NC	No Connection. Do Not Connect to PC Board Ground Plane.
5	GND	Ground Pin
6	GND	Ground Pin
7	GND	Ground Pin
8	GND	Ground Pin
9	NC	No Connection. Do Not Connect to PC Board Ground Plane.
10	RFOUT	RF Output. Use External DC Block. RF output must be this pin to insure linearity and thermal resistance specifications.
11	NC	No Connection. Do Not Connect to PC Board Ground Plane.
12	GND	Ground Pin
13	GND	Ground Pin
14	VC	Attenuator Control Voltage
15	VDD	Supply Voltage (5V)
16	MODE	Attenuation Slope Control Set to Logic Low to Enable Negative Attenuation Slope. Set to Logic High to Enable Positive Attenuation Slope.
GND	GND	Exposed Package Ground Paddle is RF and DC Ground

## PCB Patterns

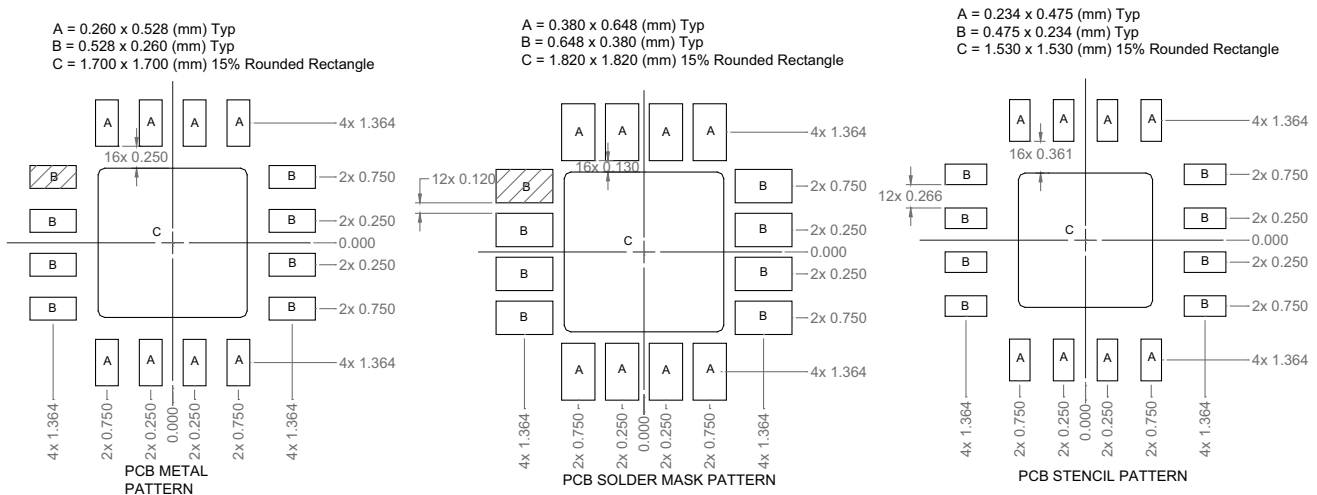

Thermal vias for center slug “C” should be incorporated into the PCB design. The number and size of thermal vias will depend on the application, the power dissipation and the electrical requirements. Example of the number and size of vias can be found on the RFMD evaluation board layout.

Evaluation Board Schematic

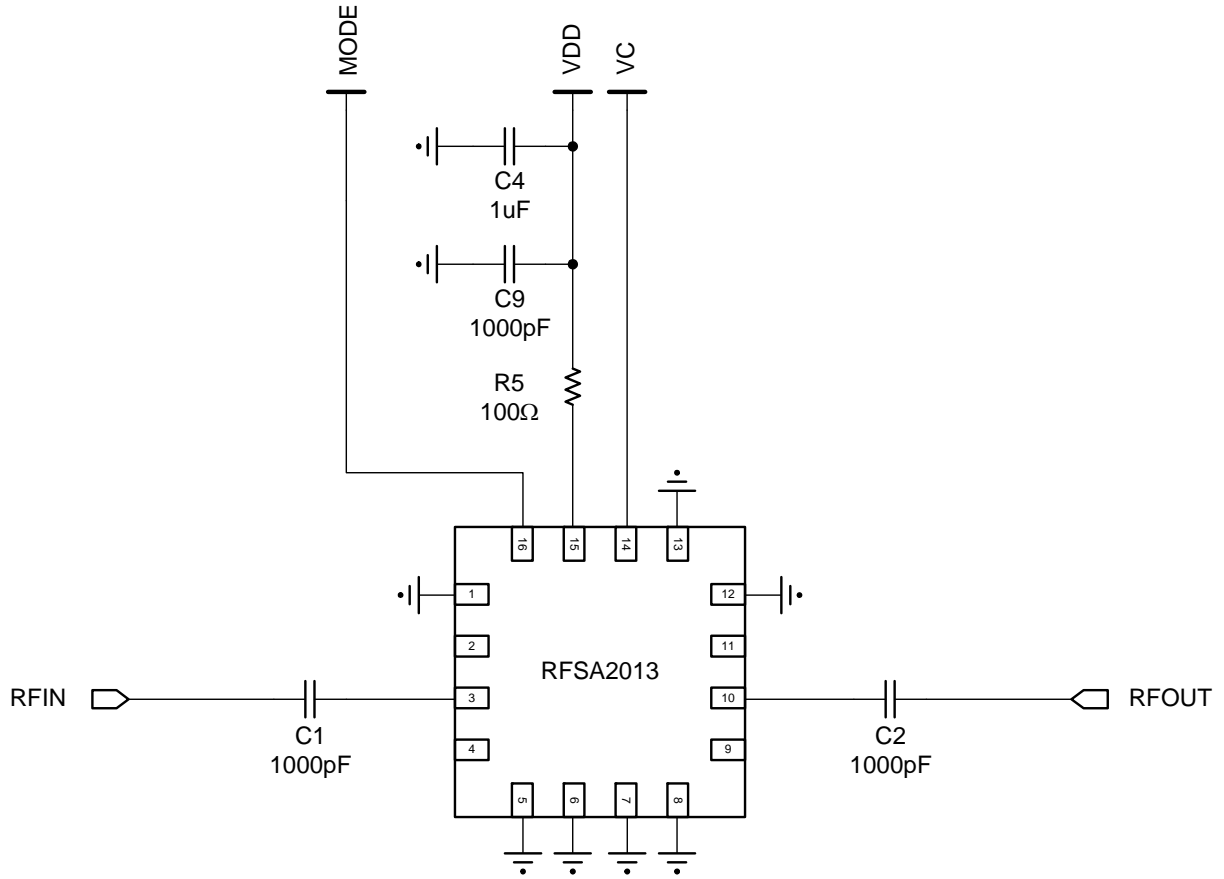

## Evaluation Board Assembly Drawing

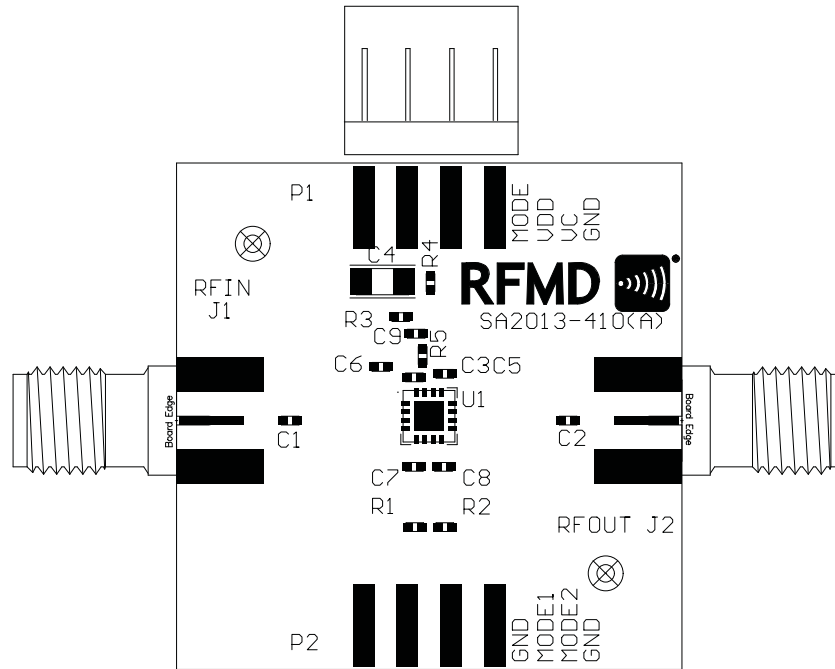

## Evaluation Board Bill of Materials (BOM)

Description	Reference Designator	Manufacturer	Manufacturer's P/N
Voltage Controlled Attenuator VCA, 5V	U1	RFMD	RFSA2013
CONN, SMA, END LNCH, MINI, FLT, 0.068"	J1-J2	Emerson Network Power	142-0741-851
CONN, HDR, SR, 4-PIN, 0.100", T/H	P1	MOLEX	22-28-4043
PCB, SA2013-410		DDI	SA2013-410
CAP, 1000pF, 10%, 25V, X7R, 0402	C1-C2, C9	Murata Electronics	GRM155R71H102KA01D
CAP, 1μF, 10%, 16V, X7R, 1206	C4	Murata Electronics	GRM31MR71E105KC01L
RES, 100Ω, 5%, 1/16W, 0402	R5	Kamaya, Inc	RMC1/16S-101JTH
DNP	C3, C5-C8	N/A	N/A
DNP	R1-R4	N/A	N/A
DNP	P2	N/A	N/A

### Notes:

1. Manufacturers' P/Ns are subject to change by the manufacturers following the issue of this document and are thereby included for reference only.
2. Contact RFMD Corporate Engineering Materials with questions regarding specific Manufacturers' P/Ns.



**Package Drawing**  
(0.9mm x 3mm x 3mm)

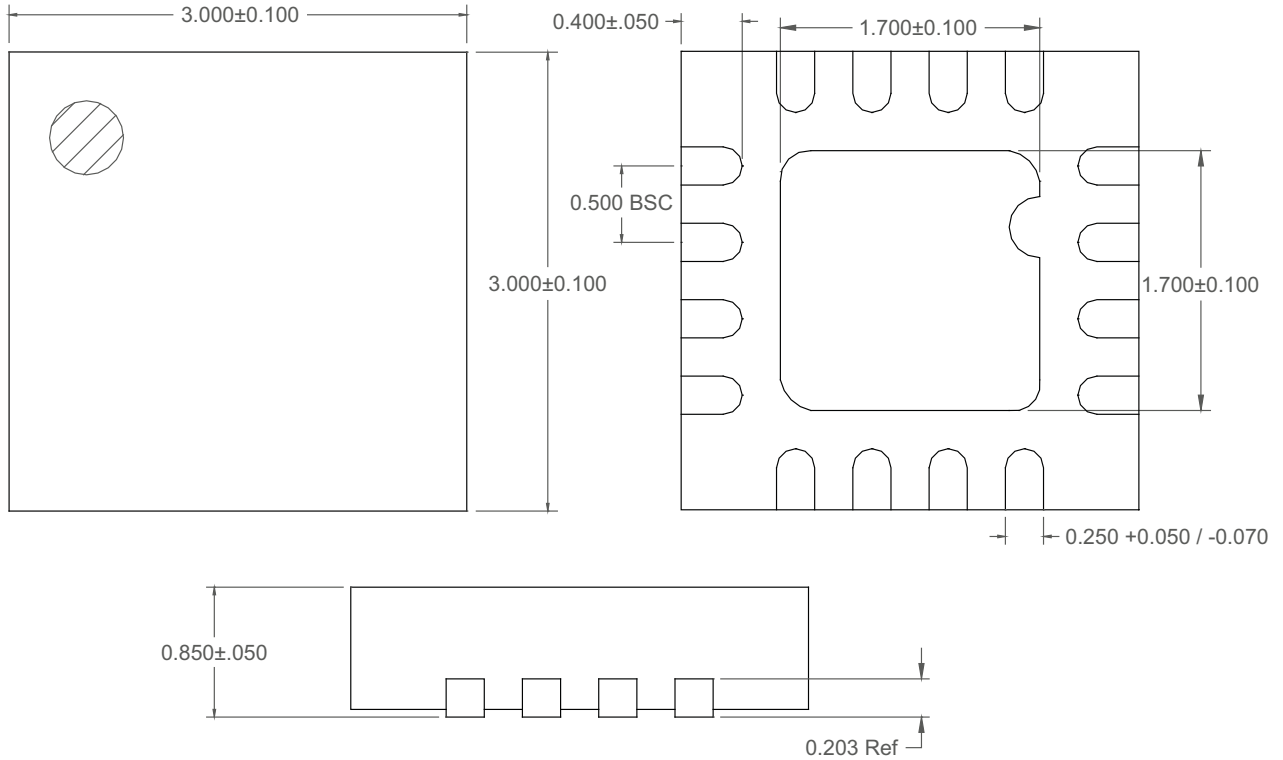

**Branding Diagram**  
(0.9mm x 3mm x 3mm)

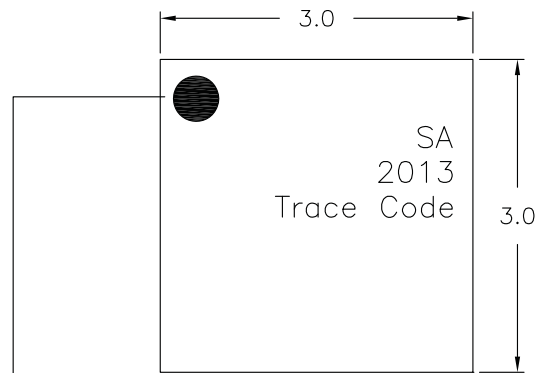

Pin 1 Indicator  
Trace Code to be assigned by SubCon



Компания «ЭлектроПласт» предлагает заключение долгосрочных отношений при поставках импортных электронных компонентов на взаимовыгодных условиях!

Наши преимущества:

- Оперативные поставки широкого спектра электронных компонентов отечественного и импортного производства напрямую от производителей и с крупнейших мировых складов;
- Поставка более 17-ти миллионов наименований электронных компонентов;
- Поставка сложных, дефицитных, либо снятых с производства позиций;
- Оперативные сроки поставки под заказ (от 5 рабочих дней);
- Экспресс доставка в любую точку России;
- Техническая поддержка проекта, помощь в подборе аналогов, поставка прототипов;
- Система менеджмента качества сертифицирована по Международному стандарту ISO 9001;
- Лицензия ФСБ на осуществление работ с использованием сведений, составляющих государственную тайну;
- Поставка специализированных компонентов (Xilinx, Altera, Analog Devices, Intersil, Interpoint, Microsemi, Aeroflex, Peregrine, Syfer, Eurofarad, Texas Instrument, Miteq, Cobham, E2V, MA-COM, Hittite, Mini-Circuits, General Dynamics и др.);

Помимо этого, одним из направлений компании «ЭлектроПласт» является направление «Источники питания». Мы предлагаем Вам помощь Конструкторского отдела:

- Подбор оптимального решения, техническое обоснование при выборе компонента;
- Подбор аналогов;
- Консультации по применению компонента;
- Поставка образцов и прототипов;
- Техническая поддержка проекта;
- Защита от снятия компонента с производства.



#### Как с нами связаться

**Телефон:** 8 (812) 309 58 32 (многоканальный)

**Факс:** 8 (812) 320-02-42

**Электронная почта:** [org@eplast1.ru](mailto:org@eplast1.ru)

**Адрес:** 198099, г. Санкт-Петербург, ул. Калинина, дом 2, корпус 4, литера А.