



MICROCHIP

**MCP3903
ADC Evaluation Board
for 16-Bit MCUs
User's Guide**

Note the following details of the code protection feature on Microchip devices:

- Microchip products meet the specification contained in their particular Microchip Data Sheet.
- Microchip believes that its family of products is one of the most secure families of its kind on the market today, when used in the intended manner and under normal conditions.
- There are dishonest and possibly illegal methods used to breach the code protection feature. All of these methods, to our knowledge, require using the Microchip products in a manner outside the operating specifications contained in Microchip's Data Sheets. Most likely, the person doing so is engaged in theft of intellectual property.
- Microchip is willing to work with the customer who is concerned about the integrity of their code.
- Neither Microchip nor any other semiconductor manufacturer can guarantee the security of their code. Code protection does not mean that we are guaranteeing the product as "unbreakable."

Code protection is constantly evolving. We at Microchip are committed to continuously improving the code protection features of our products. Attempts to break Microchip's code protection feature may be a violation of the Digital Millennium Copyright Act. If such acts allow unauthorized access to your software or other copyrighted work, you may have a right to sue for relief under that Act.

Information contained in this publication regarding device applications and the like is provided only for your convenience and may be superseded by updates. It is your responsibility to ensure that your application meets with your specifications. MICROCHIP MAKES NO REPRESENTATIONS OR WARRANTIES OF ANY KIND WHETHER EXPRESS OR IMPLIED, WRITTEN OR ORAL, STATUTORY OR OTHERWISE, RELATED TO THE INFORMATION, INCLUDING BUT NOT LIMITED TO ITS CONDITION, QUALITY, PERFORMANCE, MERCHANTABILITY OR FITNESS FOR PURPOSE. Microchip disclaims all liability arising from this information and its use. Use of Microchip devices in life support and/or safety applications is entirely at the buyer's risk, and the buyer agrees to defend, indemnify and hold harmless Microchip from any and all damages, claims, suits, or expenses resulting from such use. No licenses are conveyed, implicitly or otherwise, under any Microchip intellectual property rights.

Trademarks

The Microchip name and logo, the Microchip logo, dsPIC, KEELOQ, KEELOQ logo, MPLAB, PIC, PICmicro, PICSTART, PIC³² logo, rfPIC and UNI/O are registered trademarks of Microchip Technology Incorporated in the U.S.A. and other countries.

FilterLab, Hampshire, HI-TECH C, Linear Active Thermistor, MXDEV, MXLAB, SEEVAL and The Embedded Control Solutions Company are registered trademarks of Microchip Technology Incorporated in the U.S.A.

Analog-for-the-Digital Age, Application Maestro, chipKIT, chipKIT logo, CodeGuard, dsPICDEM, dsPICDEM.net, dsPICworks, dsSPEAK, ECAN, ECONOMONITOR, FanSense, HI-TIDE, In-Circuit Serial Programming, ICSP, Mindi, MiWi, MPASM, MPLAB Certified logo, MPLIB, MPLINK, mTouch, Omniscient Code Generation, PICC, PICC-18, PICDEM, PICDEM.net, PICkit, PICtail, REAL ICE, rfLAB, Select Mode, Total Endurance, TSHARC, UniWinDriver, WiperLock and ZENA are trademarks of Microchip Technology Incorporated in the U.S.A. and other countries.

SQTP is a service mark of Microchip Technology Incorporated in the U.S.A.

All other trademarks mentioned herein are property of their respective companies.

© 2011, Microchip Technology Incorporated, Printed in the U.S.A., All Rights Reserved.

 Printed on recycled paper.

ISBN: 978-1-61341-426-2

QUALITY MANAGEMENT SYSTEM
CERTIFIED BY DNV
== ISO/TS 16949:2009 ==

Microchip received ISO/TS-16949:2009 certification for its worldwide headquarters, design and wafer fabrication facilities in Chandler and Tempe, Arizona; Gresham, Oregon and design centers in California and India. The Company's quality system processes and procedures are for its PIC[®] MCUs and dsPIC[®] DSCs, KEELOQ[®] code hopping devices, Serial EEPROMs, microperipherals, nonvolatile memory and analog products. In addition, Microchip's quality system for the design and manufacture of development systems is ISO 9001:2000 certified.



MCP3903 ADC EVALUATION BOARD FOR 16-BIT MCUs USER'S GUIDE

Table of Contents

Preface	1
Introduction.....	1
Document Layout	1
Conventions Used in this Guide	2
Recommended Reading.....	3
The Microchip Web Site	3
Customer Support	3
Document Revision History	3
Chapter 1. Hardware Description	
1.1 Overview	5
1.2 PIM Module / MCP3903 Connection and Peripheral Usage Overview	7
1.3 Analog Input Structure	9
1.4 USB to Serial Converter	9
Chapter 2. Code Example	
2.1 dsPIC33 Example Description	11
Appendix A. Schematics and Layouts	
A.1 Introduction	15
A.2 Schematic - Analog	16
A.3 Schematic - LCD and UART	17
A.4 Schematic - USB and Memory	18
A.5 Schematic - Microcontroller (MCU)	19
A.6 Schematic - PIM Module	20
A.7 Schematic - Power	21
A.8 Board - Top Trace and Top Silk	22
A.9 Board - Bottom Trace and Bottom Silk	22
A.10 Board - Layer #2 VDD	23
A.11 Board - Layer #3 GND	23
A.12 Board - Top SILK and PADS	24
A.13 Board - Bottom SILK and PADS	24
Appendix B. Bill of Materials (BOM)	
Worldwide Sales and Service	28

MCP3903 ADC Evaluation Board for 16-Bit MCUs User's Guide



MCP3903 ADC EVALUATION BOARD FOR 16-BIT MCUs USER'S GUIDE

Preface

NOTICE TO CUSTOMERS

All documentation becomes dated, and this manual is no exception. Microchip tools and documentation are constantly evolving to meet customer needs, so some actual dialogs and/or tool descriptions may differ from those in this document. Please refer to our web site (www.microchip.com) to obtain the latest documentation available.

Documents are identified with a “DS” number. This number is located on the bottom of each page, in front of the page number. The numbering convention for the DS number is “DSXXXXA”, where “XXXX” is the document number and “A” is the revision level of the document.

For the most up-to-date information on development tools, see the MPLAB® IDE on-line help. Select the Help menu, and then Topics to open a list of available on-line help files.

INTRODUCTION

This chapter contains general information that will be useful to know before using the MCP3903 ADC Evaluation Board for 16-Bit MCUs. Items discussed in this chapter include:

- Document Layout
- Conventions Used in this Guide
- Recommended Reading
- The Microchip Web Site
- Customer Support
- Document Revision History

DOCUMENT LAYOUT

This document describes how to use the MCP3903 ADC Evaluation Board for 16-Bit MCUs as a development tool to emulate and debug firmware on a target board. The manual layout is as follows:

- **Chapter 1. “Hardware Description”**– Provides important information about the hardware.
- **Chapter 2. “Code example”**– Describes the firmware.
- **Appendix A. “Schematics and Layouts”**– Shows the schematic and board layouts.
- **Appendix B. “Bill of Materials (BOM)”** – Lists the parts used to build the MCP3903 ADC Evaluation Board for 16-Bit MCUs.

MCP3903 ADC Evaluation Board for 16-Bit MCUs User's Guide

CONVENTIONS USED IN THIS GUIDE

This manual uses the following documentation conventions:

DOCUMENTATION CONVENTIONS

Description	Represents	Examples
Arial font:		
Italic characters	Referenced books	<i>MPLAB[®] IDE User's Guide</i>
	Emphasized text	...is the <i>only</i> compiler...
Initial caps	A window	the Output window
	A dialog	the Settings dialog
	A menu selection	select Enable Programmer
Quotes	A field name in a window or dialog	"Save project before build"
Underlined, italic text with right angle bracket	A menu path	<u><i>File>Save</i></u>
Bold characters	A dialog button	Click OK
	A tab	Click the Power tab
N'Rnnnn	A number in verilog format, where N is the total number of digits, R is the radix and n is a digit.	4'b0010, 2'hF1
Text in angle brackets < >	A key on the keyboard	Press <Enter>, <F1>
Courier New font:		
Plain Courier New	Sample source code	#define START
	Filenames	autoexec.bat
	File paths	c:\mcc18\h
	Keywords	_asm, _endasm, static
	Command-line options	-Opa+, -Opa-
	Bit values	0, 1
	Constants	0xFF, 'A'
Italic Courier New	A variable argument	<i>file.o</i> , where <i>file</i> can be any valid filename
Square brackets []	Optional arguments	mcc18 [options] <i>file</i> [options]
Curly brackets and pipe character: { }	Choice of mutually exclusive arguments; an OR selection	errorlevel {0 1}
Ellipses...	Replaces repeated text	var_name [, var_name...]
	Represents code supplied by user	void main (void) { ... }

RECOMMENDED READING

This User's Guide describes how to use MCP3903 ADC Evaluation Board for 16-Bit MCUs. Other useful documents are listed below. The following Microchip document is available and recommended as a supplemental reference resource:

- **MCP3903 Data Sheet - “Six Channel Delta Sigma A/D Converter” (DS25048B)**

THE MICROCHIP WEB SITE

Microchip provides online support via our web site at www.microchip.com. This web site is used as a means to make files and information easily available to customers. Accessible by using your favorite Internet browser, the web site contains the following information:

- **Product Support** – Data sheets and errata, application notes and sample programs, design resources, user's guides and hardware support documents, latest software releases and archived software
- **General Technical Support** – Frequently Asked Questions (FAQs), technical support requests, online discussion groups, Microchip consultant program member listing
- **Business of Microchip** – Product selector and ordering guides, latest Microchip press releases, listing of seminars and events, listings of Microchip sales offices, distributors and factory representatives

CUSTOMER SUPPORT

Users of Microchip products can receive assistance through several channels:

- Distributor or Representative
- Local Sales Office
- Field Application Engineer (FAE)
- Technical Support

Customers should contact their distributor, representative or field application engineer (FAE) for support. Local sales offices are also available to help customers. A listing of sales offices and locations is included in the back of this document.

Technical support is available through the web site at: <http://support.microchip.com>.

DOCUMENT REVISION HISTORY

Revision A (July 2011)

- Initial Release of this Document.

MCP3903 ADC Evaluation Board for 16-Bit MCUs User's Guide

NOTES:



MCP3903 ADC EVALUATION BOARD FOR 16-BIT MCUs USER'S GUIDE

Chapter 1. Hardware Description

1.1 OVERVIEW

The MCP3903 ADC Evaluation Board for 16-Bit MCUs system lets users evaluate the performance of the MCP3903 six-channel ADC. It also provides a development platform for 16-bit PIC[®] MCU-based applications, using existing 100-pin PIM systems, compatible with the Explorer-16 and other high pincount PIC demo boards. The system comes with programmed PIC24FJ128GA010 PIM modules that communicate with the LabView GUI for data exchange and ADC setup.

1.1.1 Feature Highlights

- Six-channel ADC MCP3903 output display using serial communication to the PC Software Interface and LCD
- Simultaneous 4 ksps at 91 dB Signal-to-Noise and Distortion Ratio (SINAD) performance. The ADC can run up to 64 ksps.
- System and ADC performance analysis through graphical PC tools showing Time domain scope plot, Frequency Domain (FFT), and statistical numerical analysis.
- Robust hardware design with analog grounding and analog/digital separation, allowing low noise evaluation of the MCP3903 devices. Separate power supplies and power planes - 4 layer board.
- Pigtail Plus connectors for Explorer-16 daughter board compatibility.

MCP3903 ADC Evaluation Board for 16-Bit MCUs User's Guide

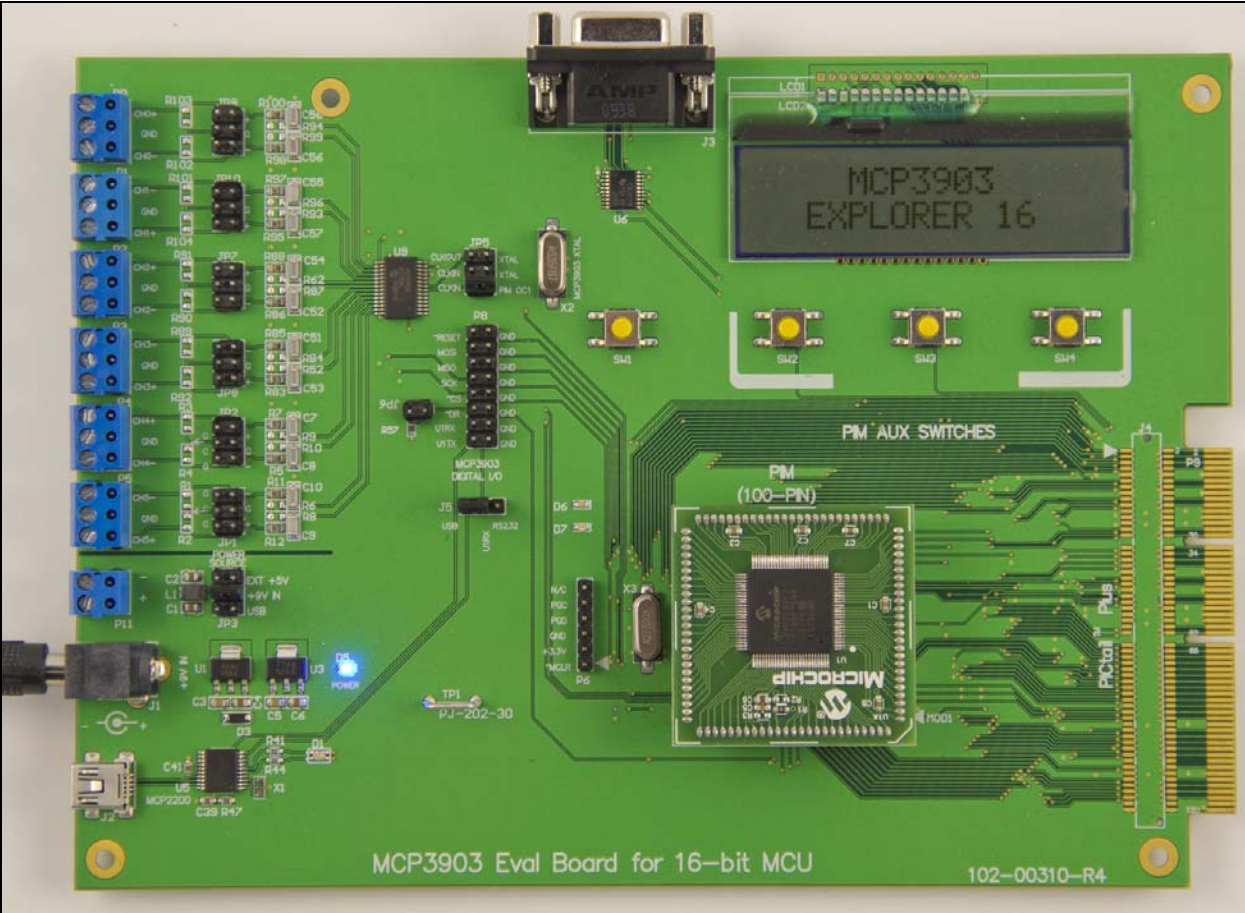

FIGURE 1-1: MCP3903 ADC Evaluation Board for 16-Bit MCUs.

1.2 PIM MODULE / MCP3903 CONNECTION AND PERIPHERAL USAGE OVERVIEW

The MCP3903 ADC Evaluation Board for 16-Bit MCUs contains a 100-pin PIM socket, compatible with Microchip's PIM modules. The system comes with a PIM module: the PIC24FJ128GA010.

For a complete description of the firmware programmed with these two modules, see [Chapter 1. "Hardware Description"](#).

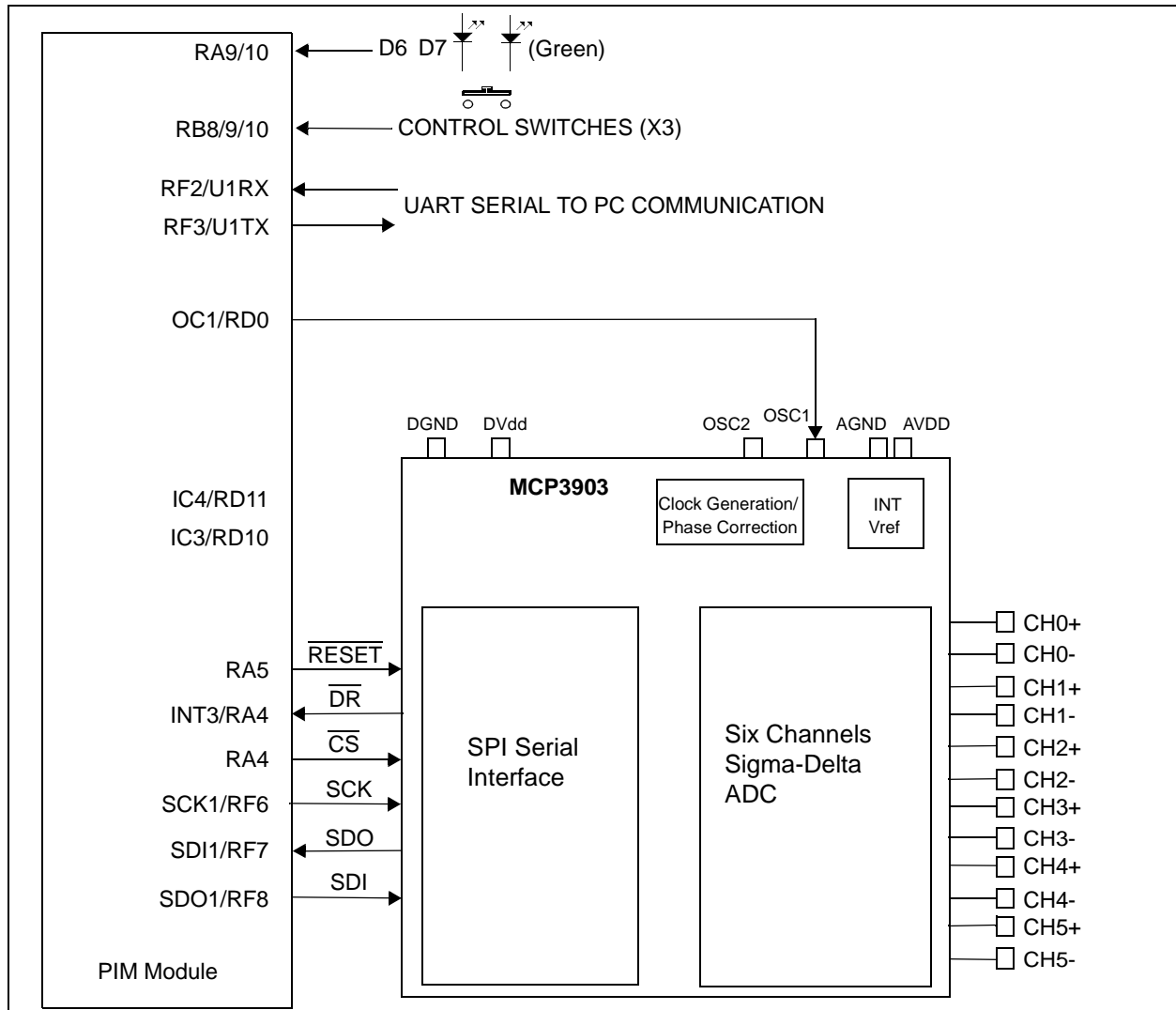

FIGURE 1-2: Digital Connection Overview PIM/MCP3903 Connections.

Ports A, B, and D are used for signals such as push buttons, output LEDs, \overline{CS} and \overline{MCLR} (for MCP3903 data mode setting). Output Capture 1 is used for MCP3903's clock generation. Serial communication is achieved through the MSSP module 1.

The MCP3903 device is an ADC with a second order modulator and a third order sync filter. This Delta-Sigma A/D converter has an adjustable oversampling ratio. The CLKIN pin of the MCP3903 is the ADC's clock (MCLK) input. The MCP3903 ADC Evaluation Board for 16-Bit MCUs offers two different options for the MCP3903 master clock (MCLK).

1.2.1 Using the Crystal X2

The MCP3903 ADC Evaluation Board for 16-Bit MCUs is populated with a 3.58 MHz crystal, being used as a clock source, by placing jumpers in the following position on the MCP3903 Digital I/O header block:

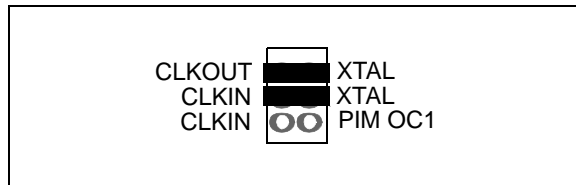

FIGURE 1-3: ADC Clock Selection Jumpers - External Crystal.

1.2.2 Driving the Clock with the PIM Module

The PIC® MCU can be used to generate the CLKIN (MCLK) signal for the MCP3903, setting the ADC sample rate through the use of the output compare module OC1. To use this, make the following jumper change to the MCP3903 Digital I/O header block:

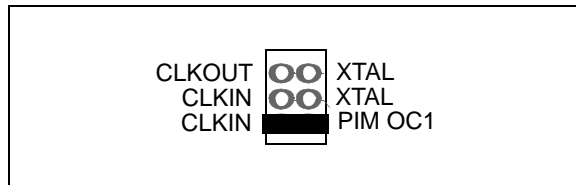

FIGURE 1-4: ADC Clock Selection Jumpers - Clock from MCU.

The signal frequency from OC1 can be changed by the user from the PC software by changing the value in the **Sampling Speed Control** box from the **Edit** menu. A low number will generate a high frequency signal. The value of the sampling rate, which is directly proportional to the clock frequency from OC1, is indicated in the sampling speed indicator box in the PC software (see Figure 2-3) for the dsPIC33 example. In the PIC24F example, the sampling speed is constant at 4.8 ksp/s, regardless of the OSR value.

1.3 ANALOG INPUT STRUCTURE

Two differential input paths allow external signal sources to be easily connected to the MCP3903 input. Edge connectors JP1 and JP2 are 3-pin connectors that act both as crew-type and clip-on post connectors.

Note: To use an edge connector as a post connector, pull up the blue plastic top to access the posts.

JP1 and JP2 can be used to force either channel from a differential to a single-ended configuration. R3 and R4 (on CH0), and R1 and R2 (on CH2) act as locations for burden resistor connectors for any current transformer inputs.

1.4 USB TO SERIAL CONVERTER

The MCP3903 ADC Evaluation Board for 16-Bit MCUs also contains a USB connection for connecting the evaluation board to a PC. On the board, there is an MCP2200 USB to UART converter that creates a virtual COM port on the PC. The MCP3903 ADC Evaluation Board for 16-Bit MCUs also features a RS232 connector just in case it is required. The RS232 Line driver is connected to the same UART pins of the MCU. For this reason, a 3-pin jumper (J5) is present on the evaluation board to select which serial communication will be used: USB or RS232. The following figure summarizes the connections between the ADC, MCU, USB to serial converter and RS232 line driver.

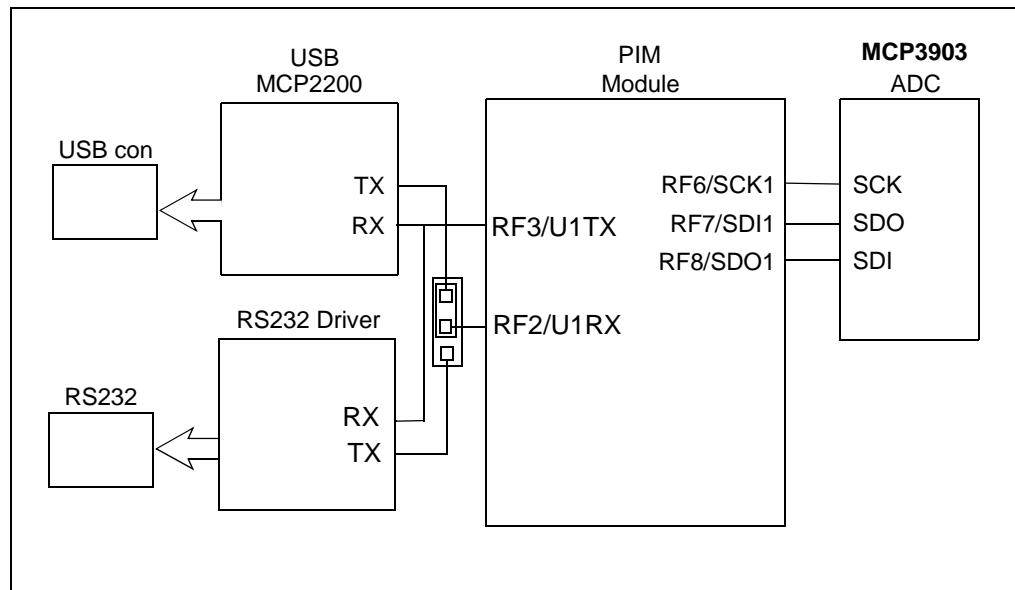

FIGURE 1-5: Serial Communication Block Diagram.

MCP3903 ADC Evaluation Board for 16-Bit MCUs User's Guide

NOTES:

Chapter 2. Code Example

2.1 DSPIC33 EXAMPLE DESCRIPTION

If the user needs to evaluate the ADC on a system that uses dsPIC33 microcontrollers, then a PIM connector with a dsPIC33FJ256GA710A can be used on the evaluation board.

Using this example, the user can modify all MCP3903 internal registers from the PC software "MCP390x Data VIEW". The UART communication speed is at 115.2 kbps.

2.1.1 SPI Communication

To transfer data from the ADC to the MCU, the SPI communication is controlled by DMA1. DMA1 channel is set up to use nul data write to read the MCP3903 register correctly. The DMA1 reads 7 bytes, but the first byte is not used. Before a new DMA read takes place, the CS pin must be controlled in the software and the MCU must wait for a new external interrupt 3 that indicates a new acquisition.

After the DMA1 transfer is finished, the DMA buffer content is moved into the Vch0 and Vch1 buffers. The loop is repeated until Vch0 and Vch1 are filled.

Timer 8 and Timer 9 are configured to work as a 32-bit timer. This timer starts when the acquisition is started and stopped when data buffers are full. The value indicated by this timer will be used to evaluate the sampling speed of the ADC on the PC interface.

After the buffers are filled with the samples, the internal registers of MCP3903 are read also using DMA1, now configured to read 16 bytes. The state of the MCP3903 internal registers will be stored into the MCU, since later they will be sent to the PC GUI.

To set the MCP3903 configuration registers, MCU must write on the SPI bus. For this purpose, the DMA0 channel is used and is set to do a thirteen bytes transfer from MCU to MCP3903.

2.1.2 UART Communication

To send the acquired samples from the MCU to the PC, the UART peripheral is used. On the board, the user can use the RS232 DB9 connector to connect to a serial port on PC side, or it can use the USB port that creates a virtual serial port on the PC, thanks to the MCP2200 USB to TTL converter that is connected to the MCU.

The RX pins of the MAX2323 and the MCP2200 are tightened together with the TX pin of the UART2 from the MCU. The user needs to select from jumperJ5 if the MCU receives data from MCP2200 or MAX2323. In firmware, the MCU is using DMA2 to do the transfer from MCU to the PC. To receive data from the PC through UART, the RX interrupt is used.

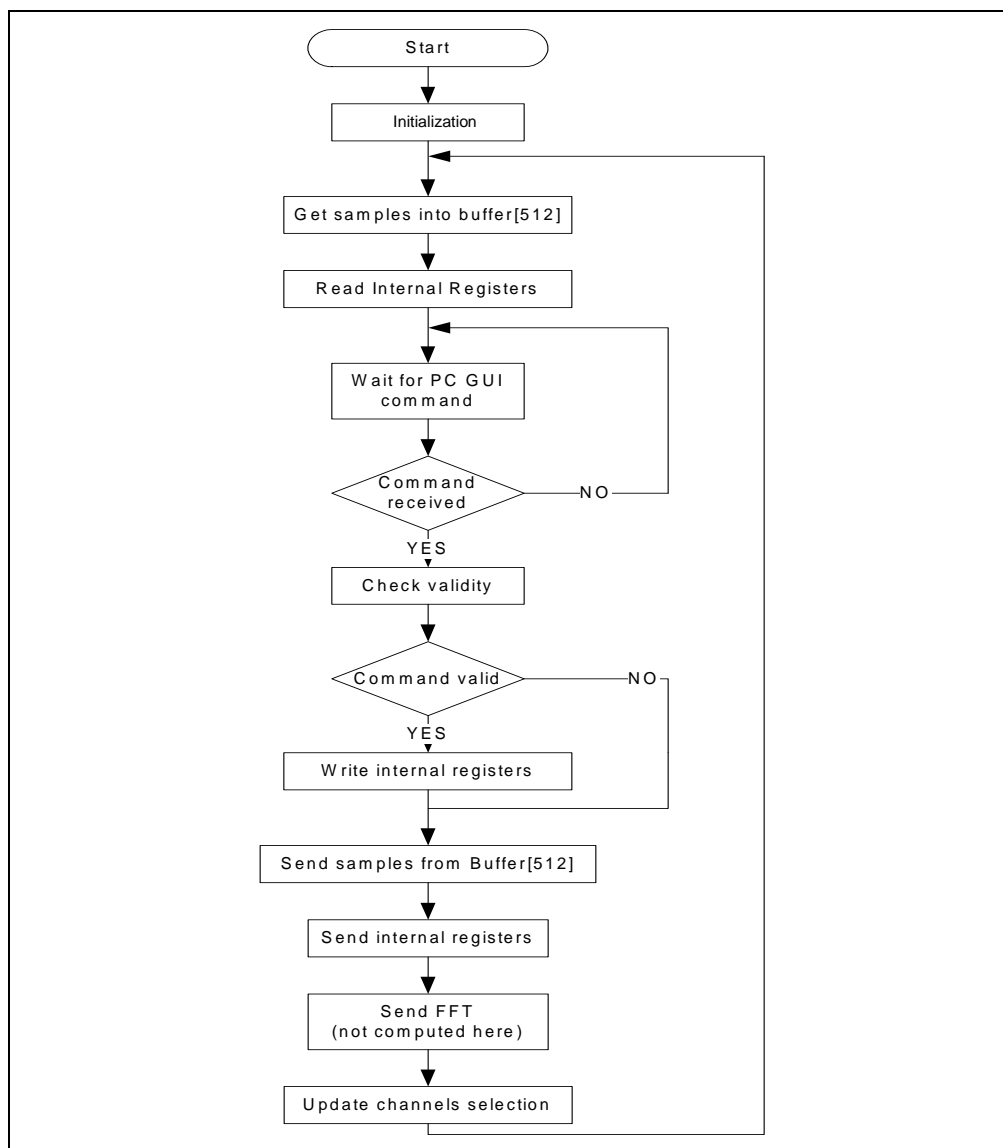

FIGURE 2-1: dsPIC33 Example Flow Chart.

2.1.3 PC Software

The PC receives the data and displays it on the MCP390x Data View. The program can display and process only two channels at the same time. To select the desired channels, the SW4 (RD13) must be pressed.

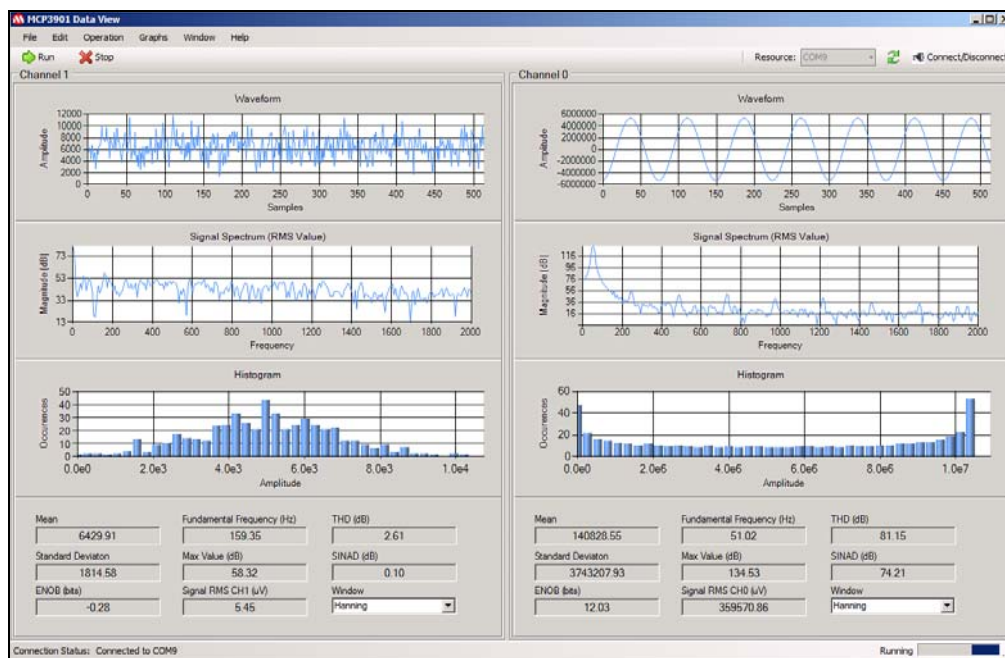

FIGURE 2-2: MCP3903 Data View Software - Main Screen.

Connectivity is done through the serial port. First, the user must identify the com port number from **My computer > Manage > Device Manager**. After this, in “VISA resource names”, users must find and select the correct com port number. Only after this, can the START button be pressed to begin the data acquisition.

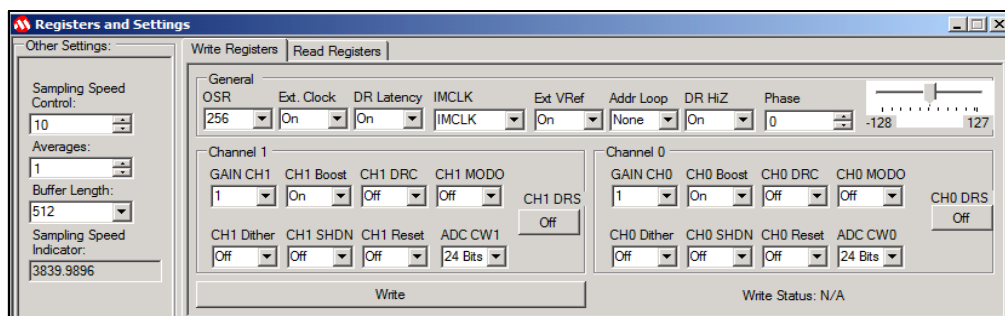

FIGURE 2-3: MCP3903 Data View Software - Registers and Settings Screen.

From the **Edit** menu, the user can open the **Registers and Settings** window to control the internal registers of the MCP3903, the sampling speed of the ADC or if any averaging should be done on the acquired samples.

From the buffer length, the user can select the amount of data that will be processed. The maximum length is 512. From the Sampling Speed Control, the user can change the sampling speed of the ADC. By writing a lower value, the sampling speed is increased, and for higher values it is decreased. The accurate value of the sampling speed is indicated in the Sampling speed indicator.

If the user wants to investigate the effect of averaging on the performance indicator, the desired value can be written in the “Averages” control. It must be noted that the processed buffer will decrease by a factor equal to the value of the average.

The **Write Register** and **Read Register** tabs are used to set the internal registers of the MCP3903. With the **Write Register** tab they are written and with the **Read Register** tab, the user can check the settings of the registers.

The Waveform Graphs will show the signal in Time domain, while the Signal Spectrum graphs shows the signal in Frequency domain. From the **Graphs** menu, under the **Signal Spectrum** option, the user can find the **Switch Y-axis scale** option. From here, it is possible to change the Y axis of the Signal Spectrum in linear scale or in logarithmic scale. The spectrum signal information is obtained by performing a Fast Fourier transformation over the Time domain signal. This Fourier transformation can be done after the signal has been windowed. For this, the user must select the type of window from the **Window** control on the lower area of the main window.

The Histogram Graph can be used to investigate the distribution of the codes. This is especially helpful to check if a DC signal distribution is Gaussian. From the **Graphs** menu, under the **Histogram** option, the user can **Change the number of bits**, with the default being 40.

The indicators from the lower area of the program indicate other performance parameters of the ADC. The main one is SINAD and related to it is Effective Number of Bits (ENOB), used to indicate the AC signal performance. The ENOB value is computed according to the formula below:

EQUATION 2-1:

$$ENOB = \frac{SINAD - 1.76}{6.02}$$

For DC signals, the Noise RMS signal in μV is displayed. For AC signals, the indicator will show the RMS value of the signal.



MCP3903 ADC EVALUATION BOARD FOR 16-BIT MCUs USER'S GUIDE

Appendix A. Schematics and Layouts

A.1 INTRODUCTION

This appendix contains the following schematics of the MCP3903 ADC Evaluation Board for 16-Bit MCUs.

- Schematic - Analog
- Schematic - LCD and UART
- Schematic - USB and Memory
- Schematic - Microcontroller (MCU)
- Schematic - PIM Module
- Schematic - Power
- Board - Top Trace and Top Silk
- Board - Bottom Trace and Bottom Silk
- Board - Layer #2 V_{DD}
- Board - Layer #3 GND
- Board - Top Silk and Pads
- Board - Bottom Silk and Pads

MCP3903 ADC Evaluation Board for 16-Bit MCUs User's Guide

A.8 BOARD - TOP TRACE AND TOP SILK

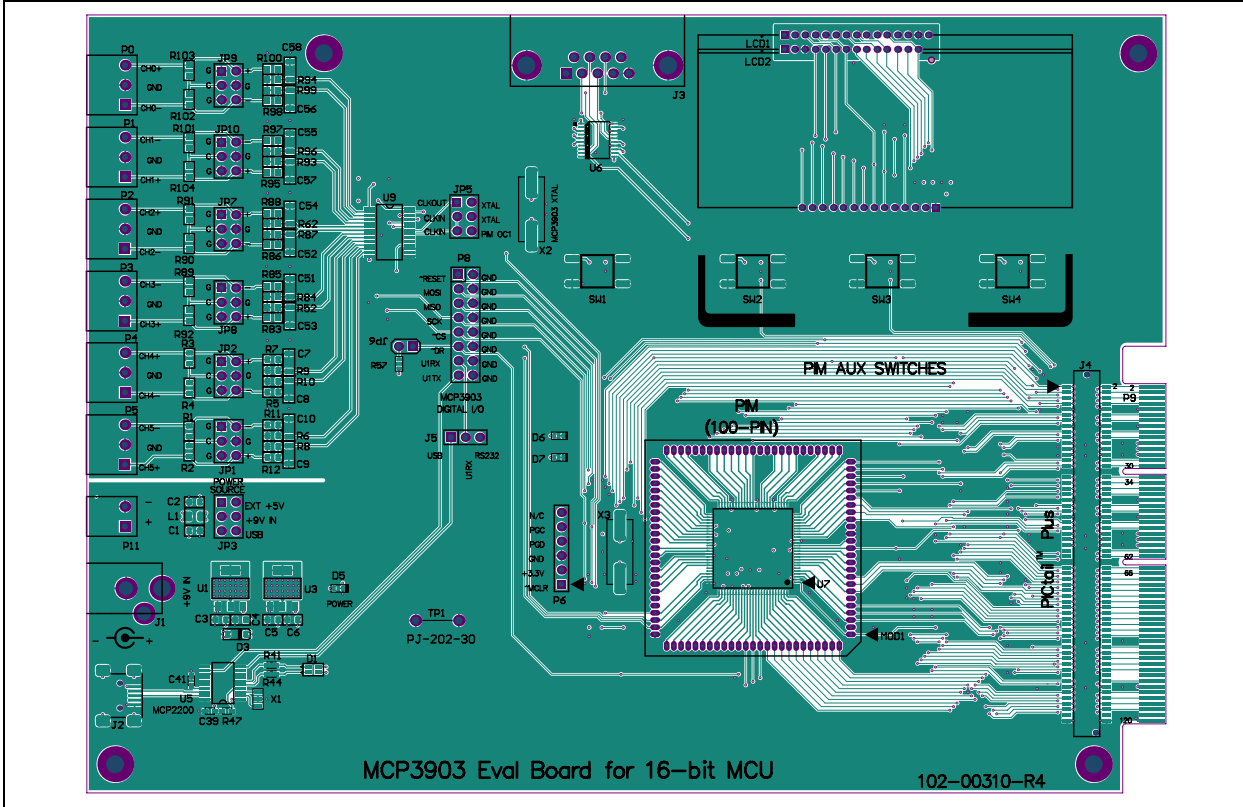

A.9 BOARD - BOTTOM TRACE AND BOTTOM SILK

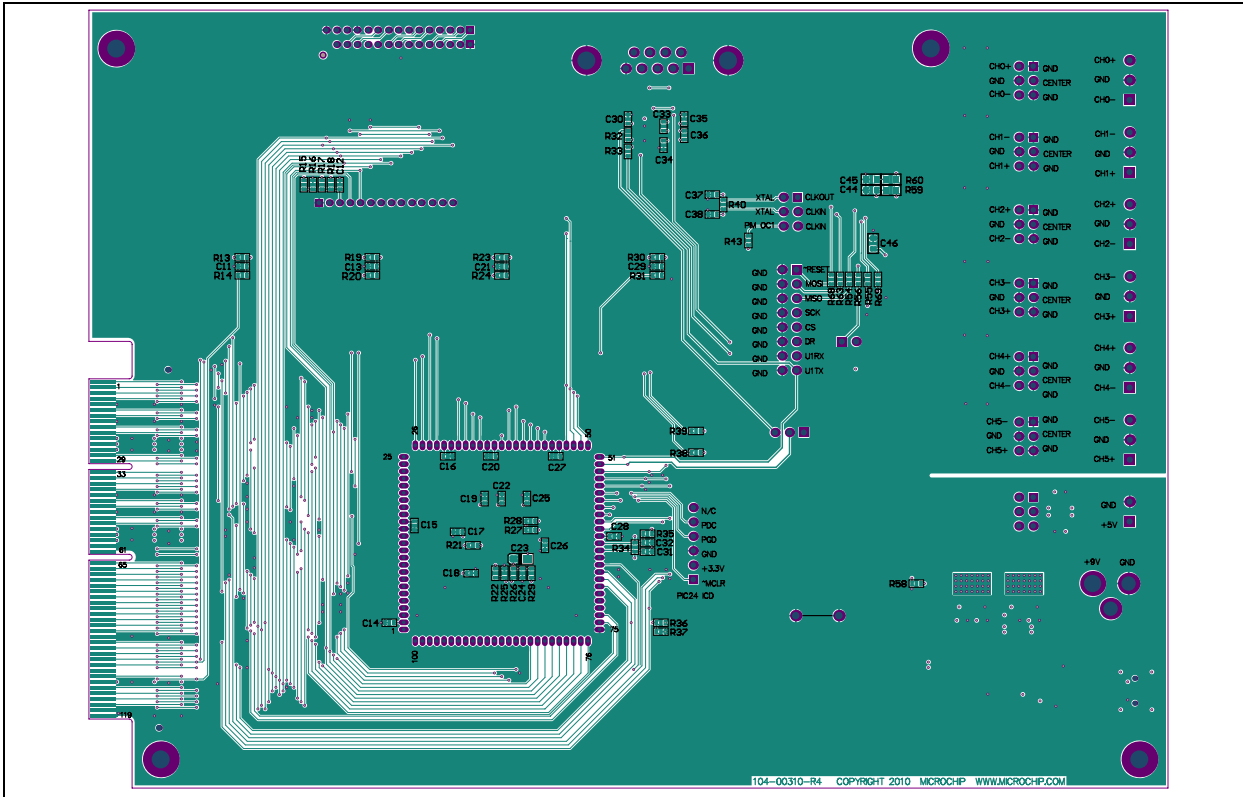

A.10 BOARD - LAYER #2 VDD

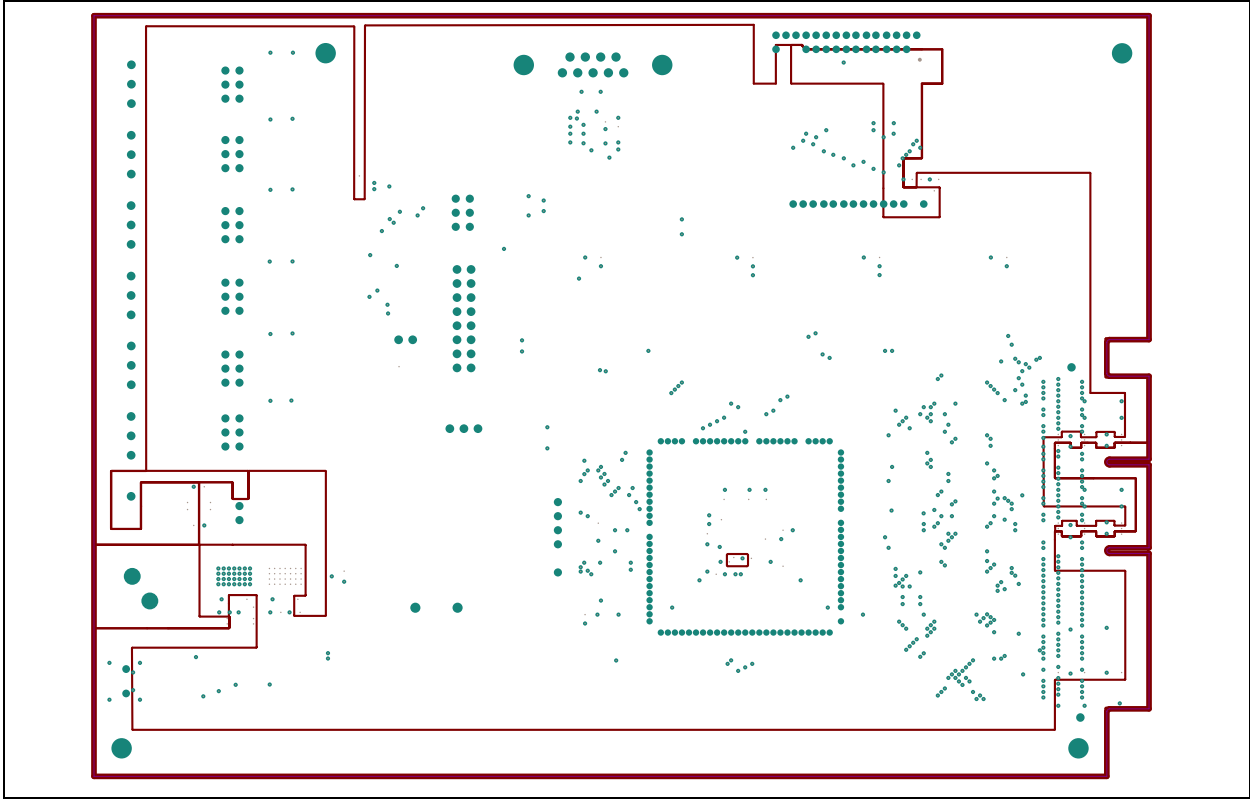

A.11 BOARD - LAYER #3 GND

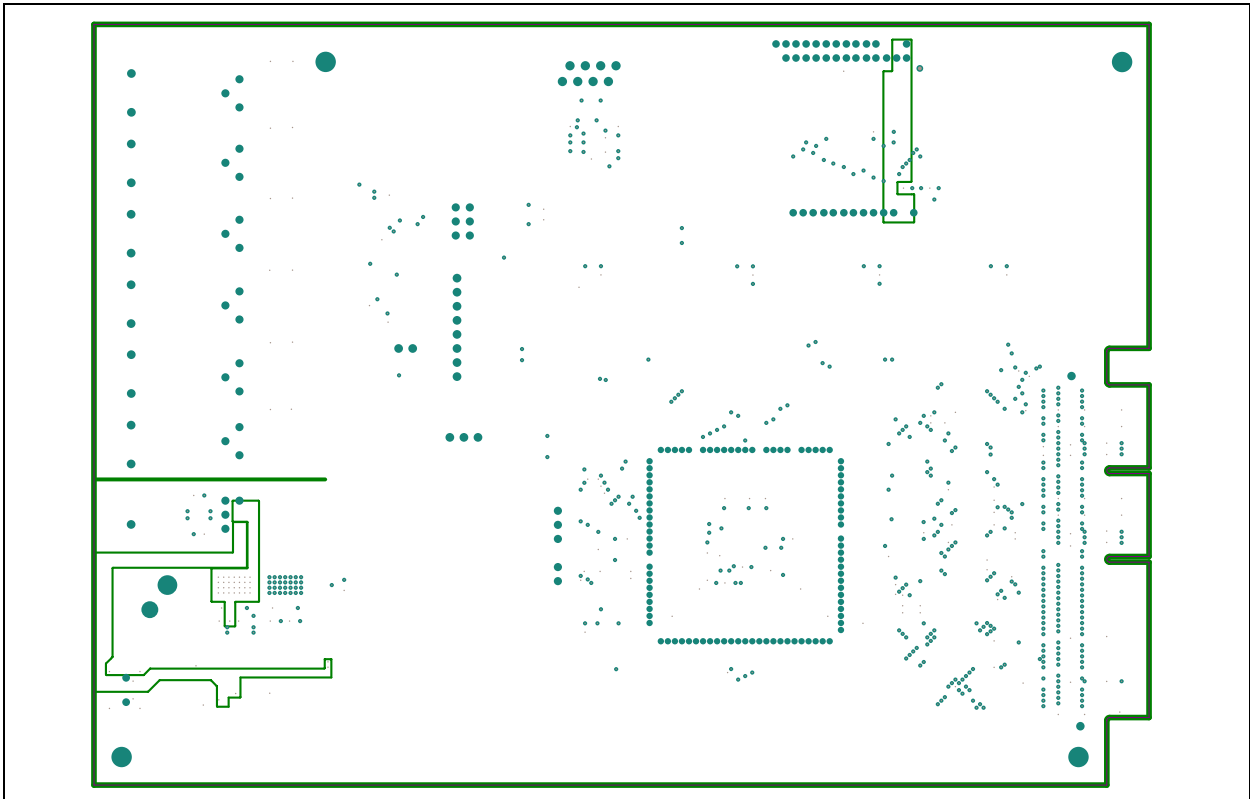

MCP3903 ADC Evaluation Board for 16-Bit MCUs User's Guide

A.12 BOARD - TOP SILK AND PADS

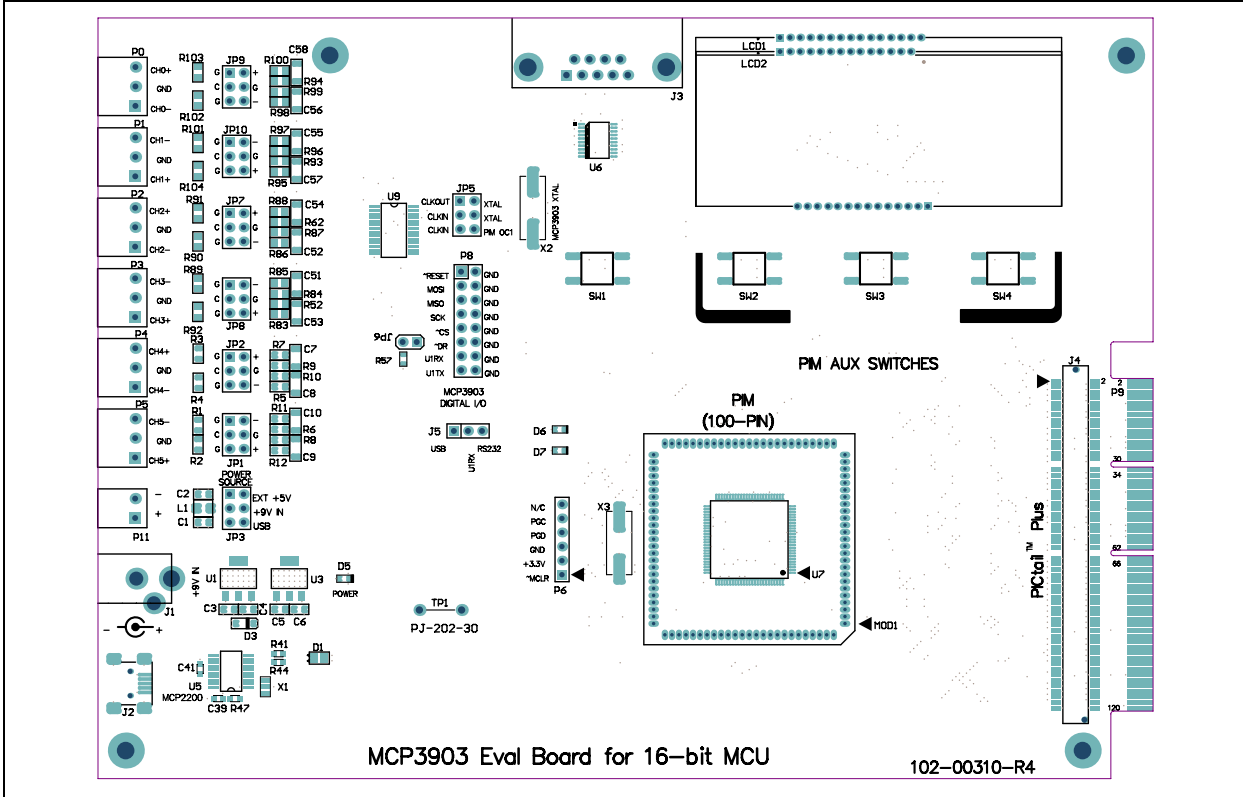

A.13 BOARD - BOTTOM SILK AND PADS

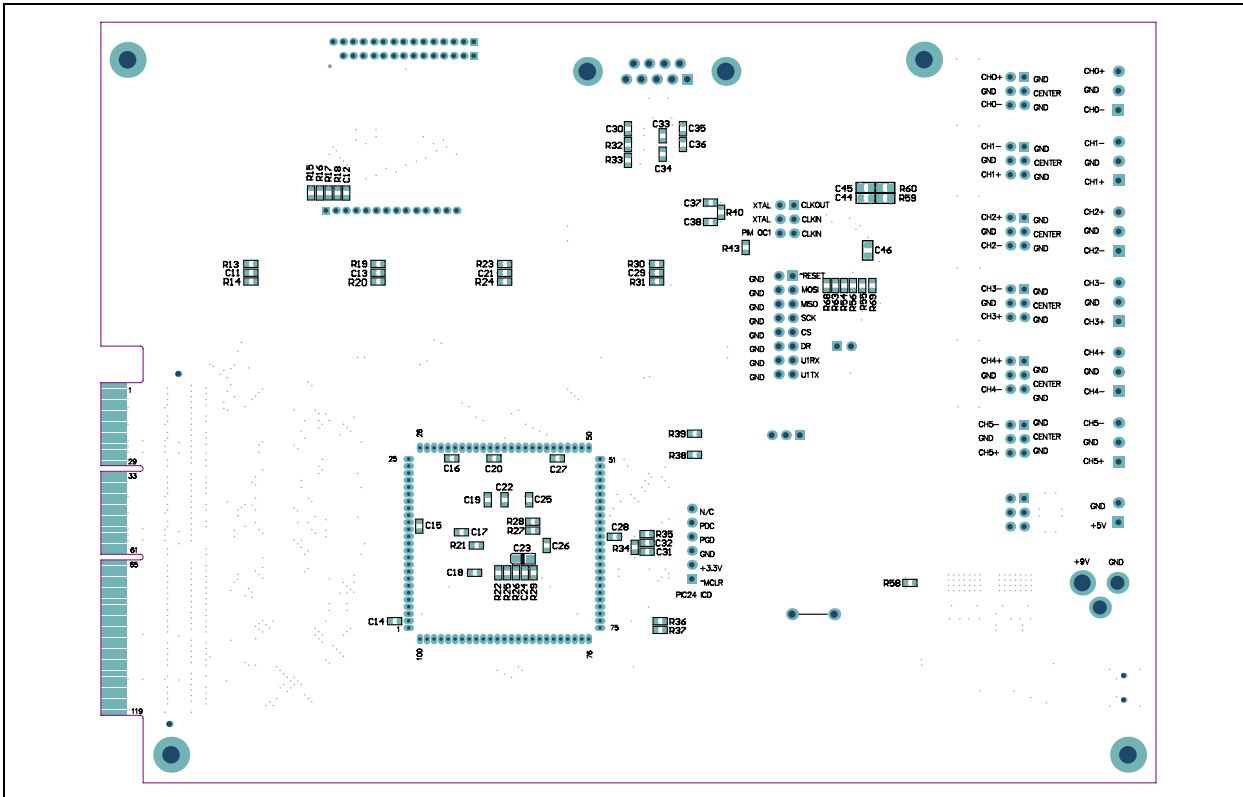



MCP3903 ADC EVALUATION BOARD FOR 16-BIT MCUs USER'S GUIDE

Appendix B. Bill of Materials (BOM)

TABLE B-1: BILL OF MATERIALS (BOM)

Qty	Reference	Description	Manufacturer	Part Number
2	C1,C4	CAP CER 10UF 16V Y5V 0805	TDK Corp.	C2012Y5V1C106Z
25	C11<->C22 C24<->C30 C33,C34,C35 C36,C39,C41	CAP CER .10UF 25V X7R 10% 0603	TDK Corp.	C1608X7R1E104K
2	C2,C6	CAP CER 4.7UF 25V Y5V 0805	TDK Corp.	C2012Y5V1E475Z
1	C23	CAPACITOR TANT 47UF 6.3V 20% SMD	Kemet®	T491A476M006AT
5	C3,C5,C44 C45,C46	CAP CER .10UF 25V X7R 10% 0805	TDK Corp.	C2012X7R1E104K
4	C31,C32 C37,C38	CAP CER 18PF 50V C0G 5% 0603	TDK Corp.	C1608C0G1H180J
12	C7,C8,C9, C10 C51<->C58	CAP CER 68000PF 25V C0G 5% 1206	TDK Corp.	C3216C0G1E683J
1	D1	LED 2X1.2MM RD/GN WTR CLR SMD	Kingbright Corp.	APHBM2012SURKCGKC
1	D3	DIODE SCHOTTKY 20V 0.5A SOD123	ON Semi.	MBR0520LT1G
1	D5	LED BLUE 470NM CLEAR LENS (0603 Blue)	Para Light Corp.	L-C191LBCT-U1
1	D6	LED 570NM GRN WHT/DIFF 0603 SMD	Rohm Semi.	SML-512MWT86
1	D7	LED RED 470NM CLEAR LENS (0603 Red)	Para Light Corp.	L-C192KRCT-U1
4	Ea. Conner of PCB	STANDOFF HEX .500/4-40THR NYLON	Keystone	1902C
4	Ea. Conner of PCB	SCREW MACH PHIL 4-40X3/8 NYLON	Building Fasteners	NY PMS 440 0038 PH
1	J1	CONN POWERJACK MINI .08" R/A T/H	Switchcraft®	RAPC722X
1	J2	Mini USB Type B Surface Mount	Samtec	MUSB-05-S-B-SM-A
1	J3	CONN D-SUB RCPT R/A 9POS 15GOLD	Tyco Electronics	1734354-2
1	J4	"DO NOT INSTALL" 120-pin MINI EDGE CARD SOCKET	Samtec	MEC1-160-02-L-D-A
1	J5	3 x 1 Header 2.54mm	-	-
8	JP1,JP2,JP3 JP5,JP7,JP8 JP9,JP10	3 X 2 Header 2.54mm on center 6 mm/2.5mm	Samtec	TSW-103-07-G-D
1	JP6	2 x 1 Header 2.54mm	-	-
9	Jumper Shunts	CONN JUMPER SHORTING TIN	Sullins Connector Solutions	STC02SYAN

Note 1: The components listed in this Bill of Materials are representative of the PCB assembly. The released BOM used in manufacturing uses all RoHS-compliant components.

Bill of Materials (BOM)

TABLE B-1: BILL OF MATERIALS (BOM) (CONTINUED)

Qty	Reference	Description	Manufacturer	Part Number
1	L1	Shielded 10uH Power Inductor 0805	Coilcraft	0805PS-103KLC
1	LCD1	"DO NOT INSTALL"	-	-
1	LCD2	16X2 FTN Reflective No. BLWT COG 3V	Tianma	TM162JCAWG1
4	MOD1	25 X 1 Header 1.27mm on center	Samtec	MTMS-125-01-G-S-230
6	P0,P1,P2,P3 P4,P5	CONN TERM BLK PLUG 6A 3.5MM 3POS	Keystone	8723
1	P0,P1,P2,P3 P4,P5,P11	TERM BLK PIN HEADER 24Pin Pos One 24 Pin Header for 1 Board (20 pins needed)	Keystone	8724
1	P11	CONN TERM BLK PLUG 6A 3.5MM 2POS	Keystone	8722
1	P6	6 x 1 Header 2.54mm	-	-
1	P8	8 X 2 CONN HEADER 8POS .100" DUAL TIN	Samtec	TSW-104-17-T-D
1	P9	"DO NOT INSTALL"	-	-
1	PCB	RoHS Compliant Bare PCB, MCP3901 Eval. Board for 16-bit MCU	-	104-00221
24	R1,R2,R3,R4 R6,R8,R9 R10,R16, R52,R62 R84,R87 R89<->R94 R96,R99 R101<->R104	(0805) "DO NOT INSTALL"	-	-
4	R13,R19 R23,R30	RES 4.70K OHM 1/10W 1% 0603 SMD	Rohm Semi.	MCR03EZPFX4701
8	R14,R20, R24, R31 R32,R33 R36, R37	RES 1.00K OHM 1/10W 1% 0603 SMD	Rohm Semi.	MCR03EZPFX1001
3	R21,R57	RES 10.0K OHM 1/10W 1% 0603 SMD	Rohm Semi.	MCR03EZPFX1002
5	R17,R18,R25 R29,R35	(0603) "DO NOT INSTALL"	-	-
2	R15,R22,R26	RES 0.0 OHM 1/10W 5% 0603 SMD	Rohm Semi.	MCR03EZPJ000
2	R27,R28	RES 2.20K OHM 1/10W 1% 0603 SMD	Rohm Semi.	MCR03EZPFX2201
2	R34,R40	RES 1.00M OHM 1/10W 1% 0603 SMD	Rohm Semi.	MCR03EZPFX1004
10	R38,R39,R43,R 54,R55,R56,R5 8 R63,R68,R69	RES 100 OHM 1/10W 1% 0603 SMD	Rohm Semi.	MCR03EZPFX1000
3	R41,R44,R47	RES 470 OHM 1/10W 5% 0603 SMD	Panasonic	ERJ-3GEYJ471V
7	R44,R70,R71, R72,R74,R75 R76	RES 100K OHM 1/10W 1% 0603 SMD	Rohm Semi.	MCR03EZPFX1003

Note 1: The components listed in this Bill of Materials are representative of the PCB assembly. The released BOM used in manufacturing uses all RoHS-compliant components.

Bill of Materials (BOM)

TABLE B-1: BILL OF MATERIALS (BOM) (CONTINUED)

Qty	Reference	Description	Manufacturer	Part Number
12	R5,R7,R11 R12,R83,R85 R86,R88,R95 R97,R98 R100	RES 1.0K OHM .1% 1/4W 0805 SMD	Susumu Co., LTD.	RGH2012-2E-P-102-B
2	R59,R60	RES 10.0 OHM 1/8W 1% 0805 SMD	Rohm Semi.	MCR10EZH10R0
4	SW1,SW2 SW3,SW4	SWITCH TACT 6MM 230GF H=4.3MM	Omron Electronic Components - ECB Division	B3S-1002P
1	TP1	Wire Test Point 0.3" Length	Components Corp.	PJ-202-30
1	U1	IC REG LDO 800MA 5.0V SOT-223	National Semi.	LM1117MP-5.0/NOPB
1	U3	IC REG LDO 800MA 3.3V SOT-223	National Semi.	LM1117MP-3.3/NOPB
1	U6	IC DRVR/RCVR MLTCH RS232 20TSSOP	Texas Instruments	SN75C3223PWR
1	U7	"DO NOT INSTALL"	-	-
1	U9	IC ENERGY METER 28SSOP	Microchip	MCP3903
1	X2	CRYSTAL 3.579545MHZ 18PFFUND SMD	Abracon Corp.	ABLS-3.579545MHZ-B2-T

Note 1: The components listed in this Bill of Materials are representative of the PCB assembly. The released BOM used in manufacturing uses all RoHS-compliant components.



MICROCHIP

Worldwide Sales and Service

AMERICAS

Corporate Office
2355 West Chandler Blvd.
Chandler, AZ 85224-6199
Tel: 480-792-7200
Fax: 480-792-7277
Technical Support:
<http://www.microchip.com/support>
Web Address:
www.microchip.com

Atlanta
Duluth, GA
Tel: 678-957-9614
Fax: 678-957-1455

Boston
Westborough, MA
Tel: 774-760-0087
Fax: 774-760-0088

Chicago
Itasca, IL
Tel: 630-285-0071
Fax: 630-285-0075

Cleveland
Independence, OH
Tel: 216-447-0464
Fax: 216-447-0643

Dallas
Addison, TX
Tel: 972-818-7423
Fax: 972-818-2924

Detroit
Farmington Hills, MI
Tel: 248-538-2250
Fax: 248-538-2260

Indianapolis
Noblesville, IN
Tel: 317-773-8323
Fax: 317-773-5453

Los Angeles
Mission Viejo, CA
Tel: 949-462-9523
Fax: 949-462-9608

Santa Clara
Santa Clara, CA
Tel: 408-961-6444
Fax: 408-961-6445

Toronto
Mississauga, Ontario,
Canada
Tel: 905-673-0699
Fax: 905-673-6509

ASIA/PACIFIC

Asia Pacific Office
Suites 3707-14, 37th Floor
Tower 6, The Gateway
Harbour City, Kowloon
Hong Kong
Tel: 852-2401-1200
Fax: 852-2401-3431

Australia - Sydney
Tel: 61-2-9868-6733
Fax: 61-2-9868-6755

China - Beijing
Tel: 86-10-8569-7000
Fax: 86-10-8528-2104

China - Chengdu
Tel: 86-28-8665-5511
Fax: 86-28-8665-7889

China - Chongqing
Tel: 86-23-8980-9588
Fax: 86-23-8980-9500

China - Hangzhou
Tel: 86-571-2819-3180
Fax: 86-571-2819-3189

China - Hong Kong SAR
Tel: 852-2401-1200
Fax: 852-2401-3431

China - Nanjing
Tel: 86-25-8473-2460
Fax: 86-25-8473-2470

China - Qingdao
Tel: 86-532-8502-7355
Fax: 86-532-8502-7205

China - Shanghai
Tel: 86-21-5407-5533
Fax: 86-21-5407-5066

China - Shenyang
Tel: 86-24-2334-2829
Fax: 86-24-2334-2393

China - Shenzhen
Tel: 86-755-8203-2660
Fax: 86-755-8203-1760

China - Wuhan
Tel: 86-27-5980-5300
Fax: 86-27-5980-5118

China - Xian
Tel: 86-29-8833-7252
Fax: 86-29-8833-7256

China - Xiamen
Tel: 86-592-2388138
Fax: 86-592-2388130

China - Zhuhai
Tel: 86-756-3210040
Fax: 86-756-3210049

ASIA/PACIFIC

India - Bangalore
Tel: 91-80-3090-4444
Fax: 91-80-3090-4123

India - New Delhi
Tel: 91-11-4160-8631
Fax: 91-11-4160-8632

India - Pune
Tel: 91-20-2566-1512
Fax: 91-20-2566-1513

Japan - Yokohama
Tel: 81-45-471- 6166
Fax: 81-45-471-6122

Korea - Daegu
Tel: 82-53-744-4301
Fax: 82-53-744-4302

Korea - Seoul
Tel: 82-2-554-7200
Fax: 82-2-558-5932 or
82-2-558-5934

Malaysia - Kuala Lumpur
Tel: 60-3-6201-9857
Fax: 60-3-6201-9859

Malaysia - Penang
Tel: 60-4-227-8870
Fax: 60-4-227-4068

Philippines - Manila
Tel: 63-2-634-9065
Fax: 63-2-634-9069

Singapore
Tel: 65-6334-8870
Fax: 65-6334-8850

Taiwan - Hsin Chu
Tel: 886-3-6578-300
Fax: 886-3-6578-370

Taiwan - Kaohsiung
Tel: 886-7-213-7830
Fax: 886-7-330-9305

Taiwan - Taipei
Tel: 886-2-2500-6610
Fax: 886-2-2508-0102

Thailand - Bangkok
Tel: 66-2-694-1351
Fax: 66-2-694-1350

EUROPE

Austria - Wels
Tel: 43-7242-2244-39
Fax: 43-7242-2244-393

Denmark - Copenhagen
Tel: 45-4450-2828
Fax: 45-4485-2829

France - Paris
Tel: 33-1-69-53-63-20
Fax: 33-1-69-30-90-79

Germany - Munich
Tel: 49-89-627-144-0
Fax: 49-89-627-144-44

Italy - Milan
Tel: 39-0331-742611
Fax: 39-0331-466781

Netherlands - Drunen
Tel: 31-416-690399
Fax: 31-416-690340

Spain - Madrid
Tel: 34-91-708-08-90
Fax: 34-91-708-08-91

UK - Wokingham
Tel: 44-118-921-5869
Fax: 44-118-921-5820

05/02/11



Компания «ЭлектроПласт» предлагает заключение долгосрочных отношений при поставках импортных электронных компонентов на взаимовыгодных условиях!

Наши преимущества:

- Оперативные поставки широкого спектра электронных компонентов отечественного и импортного производства напрямую от производителей и с крупнейших мировых складов;
- Поставка более 17-ти миллионов наименований электронных компонентов;
- Поставка сложных, дефицитных, либо снятых с производства позиций;
- Оперативные сроки поставки под заказ (от 5 рабочих дней);
- Экспресс доставка в любую точку России;
- Техническая поддержка проекта, помощь в подборе аналогов, поставка прототипов;
- Система менеджмента качества сертифицирована по Международному стандарту ISO 9001;
- Лицензия ФСБ на осуществление работ с использованием сведений, составляющих государственную тайну;
- Поставка специализированных компонентов (Xilinx, Altera, Analog Devices, Intersil, Interpoint, Microsemi, Aeroflex, Peregrine, Syfer, Eurofarad, Texas Instrument, Miteq, Cobham, E2V, MA-COM, Hittite, Mini-Circuits, General Dynamics и др.);

Помимо этого, одним из направлений компании «ЭлектроПласт» является направление «Источники питания». Мы предлагаем Вам помощь Конструкторского отдела:

- Подбор оптимального решения, техническое обоснование при выборе компонента;
- Подбор аналогов;
- Консультации по применению компонента;
- Поставка образцов и прототипов;
- Техническая поддержка проекта;
- Защита от снятия компонента с производства.



Как с нами связаться

Телефон: 8 (812) 309 58 32 (многоканальный)

Факс: 8 (812) 320-02-42

Электронная почта: org@eplast1.ru

Адрес: 198099, г. Санкт-Петербург, ул. Калинина, дом 2, корпус 4, литера А.