



# Hybrid Energy Storage Aluminum Capacitors



Image is not to scale

### FEATURES

- Polarized energy storage capacitor with high capacity and energy density
- Voltage flexibility: 1.4 V (single cell) to 2.8 V / 4.2 V / 5.6 V / 7.0 V / 8.4 V (multiple cells)
- Available in stacked through-hole (STH), radial, surface-mount flat (SMF) and lay flat configurations (LFC) with wire and connectors
- Useful life: 1000 h at 70 °C / 85 °C
- No cell balancing necessary
- Soft and low transient-voltage-controlled charging characteristic
- Non-hazardous electrolyte
- Maintenance-free, no service necessary
- Evaluation kits for engineering are available under ordering code: MAL219699001E3
- Material categorization: for definitions of compliance please see [www.vishay.com/doc?99912](http://www.vishay.com/doc?99912)



RoHS COMPLIANT

### APPLICATIONS

- Power backup for memory controller, flash backup, RAID systems, SRAM, DRAM
- Power failure and write cache protection for enterprise SSD and HDD
- Real time clock power source
- Burst power support for flash lights, wireless transmitters
- Backup power for industrial PC's and industrial controls
- Storage device for energy harvesting
- Emergency light and micro UPS power source

### MARKING

The capacitors are marked with the following information:

- Rated capacitance (in F)
- Rated voltage (in V)
- Date code
- Negative / positive terminal identification

### PACKAGING

Supplied in ESD trays only

QUICK REFERENCE DATA						
DESCRIPTION	VALUE					
	SINGLE CELL	2 CELLS	3 CELLS	4 CELLS	5 CELLS	6 CELLS
Nominal case size (Ø D x L in mm) Stacked Through-Hole (STH)	7 x 2.5 12 x 2.5 -	7 x 5 12 x 5 35 x 25 x 7.5	7 x 7.5 12 x 7.5 35 x 25 x 10	7 x 10 12 x 10 35 x 25 x 15	7 x 12.5 12 x 12.5 -	7 x 15 12 x 15 -
Nominal case size (Ø W x L x H in mm) Surface-Mount Flat (SMF)	7 x 7 x 2.5 12 x 12 x 2.5 -	7 x 14 x 2.5 12 x 24 x 2.5 -	13 x 14 x 2.5 22 x 24 x 2.5 -	14 x 14 x 2.5 24 x 24 x 2.5 -	-	-
Nominal case size (W x L x H in mm) Lay Flat (LFC)	14.5 x 12 x 2.5	14.5 x 24 x 2.5	14.5 x 36 x 2.5	14.5 x 48 x 2.5	14.5 x 60 x 2.5	14.5 x 72 x 2.5
Rated capacitance range, C <sub>R</sub>	4.0 F 15.0 F	4.0 F 15.0 F 90.0 F	4.0 F 15.0 F 90.0 F	4.0 F 15.0 F 90.0 F	4.0 F 15.0 F	4.0 F 15.0 F
Tolerance on C <sub>R</sub> at 20 °C	-20 % to +80 %					
Rated voltage, U <sub>R</sub>	1.4 V	2.8 V	4.2 V	5.6 V	7.0 V	8.4 V
Maximum surge voltage, U <sub>S</sub> (max. 30 s)	1.6 V	3.2 V	4.8 V	6.4 V	8.0 V	9.6 V
Minimum stored energy	4 Ws 17 Ws	9 Ws 35 Ws 230 Ws	13 Ws 52 Ws 345 Ws	18 Ws 70 Ws 460 Ws	22 Ws 87 Ws	27 Ws 105 Ws
Energy density	9 Ws/g to 13 Ws/g					
Category temperature range	4.0 F: -20 °C to +70 °C 15.0 F / 90.0 F: -20 °C to +85 °C					
Storage temperature range	-40 °C to +85 °C					
Useful life at U <sub>R</sub>	4.0 F: at 70 °C: 1000 h at 55 °C: 2800 h at 45 °C: 5600 h			15.0 F / 90.0 F: at 85 °C: 1000 h at 70 °C: 2800 h at 60 °C: 5600 h		
Shelf life	1000 h at upper category temperature					
Climatic category IEC 60068	25/085/21					

SELECTION CHART FOR $C_R$ , $U_R$ , AND FORM AT UPPER CATEGORY TEMPERATURE (UCT)							
$C_R$ (F)	FORM	$U_R$ (V)					
		1.4	2.8	4.2	5.6	7.0	8.4
4	A2	7.0 x 2.5	7.0 x 5.0	7.0 x 7.5	7.0 x 10.0	7.0 x 12.5	7.0 x 15.0
	B2	7.0 x 2.5	7.0 x 5.0	7.0 x 7.5	7.0 x 10.0	7.0 x 12.5	7.0 x 15.0
	B3	7.0 x 2.5	7.0 x 5.0	7.0 x 7.5	7.0 x 10.0	7.0 x 12.5	7.0 x 15.0
	C	7.0 x 7.0 x 2.5	-	-	-	-	-
	D	7.0 x 7.0 x 2.5	-	-	-	-	-
	E	-	7.0 x 14.0 x 2.5	13.0 x 14.0 x 2.5	14.0 x 14.0 x 2.5	-	-
15	A2	12.0 x 2.5	12.0 x 5.0	12.0 x 7.5	12.0 x 10.0	12.0 x 12.5	12.0 x 15.0
	B2	12.0 x 2.5	12.0 x 5.0	12.0 x 7.5	12.0 x 10.0	12.0 x 12.5	12.0 x 15.0
	B3	12.0 x 2.5	12.0 x 5.0	12.0 x 7.5	12.0 x 10.0	12.0 x 12.5	12.0 x 15.0
	C	12.0 x 12.0 x 2.5	-	-	-	-	-
	D	12.0 x 12.0 x 2.5	-	-	-	-	-
	E	-	12.0 x 24.0 x 2.5	22.0 x 24.0 x 2.5	24.0 x 24.0 x 2.5	-	-
	F	14.5 x 12.0 x 2.5	14.5 x 24.0 x 2.5	14.5 x 36.0 x 2.5	14.5 x 48.0 x 2.5	14.5 x 60.0 x 2.5	14.5 x 72.0 x 2.5
90	G	-	35 x 25 x 7.5	35 x 25 x 10	35 x 25 x 15	-	-
	H	-	35 x 25 x 7.5	35 x 25 x 10	35 x 25 x 15	-	-

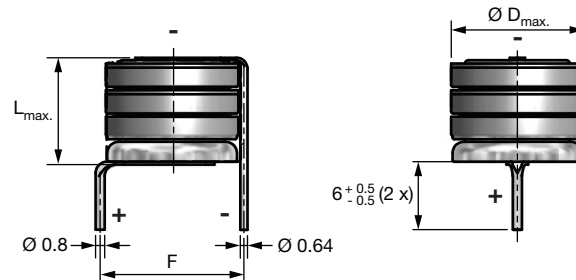
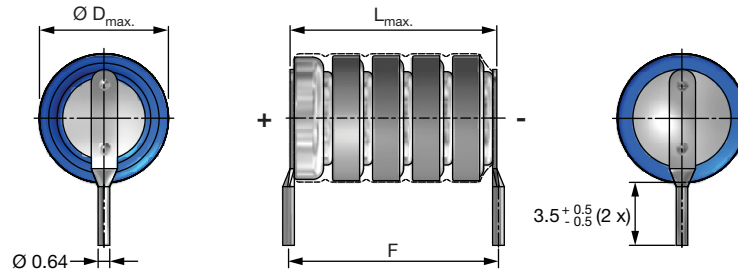
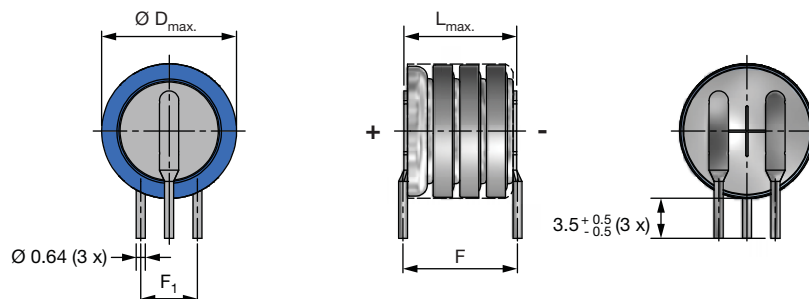
**DIMENSIONS in millimeters AND AVAILABLE FORMS**
**STACKED THROUGH HOLE CONFIGURATION (STH): Examples VERTICAL MOUNT**

 Fig. 1 - Form A2: Stacked Through Hole (example 4 cells, 2 pins) <sup>(1)</sup>
**STACKED THROUGH HOLE CONFIGURATION (STH): Examples HORIZONTAL MOUNT**

 Fig. 2 - Form B2: Stacked Through Hole (example 5 cells, 2 pins) <sup>(1)</sup>

 Fig. 3 - Form B3: Stacked Through Hole (example 4 cells, keyed polarity - 3 pins) <sup>(1)</sup>
**Note**
<sup>(1)</sup> Bottom and top are not isolated.

**DIMENSIONS** in millimeters **AND AVAILABLE FORMS**

**SURFACE MOUNT FLAT CONFIGURATION (SMF): Examples**

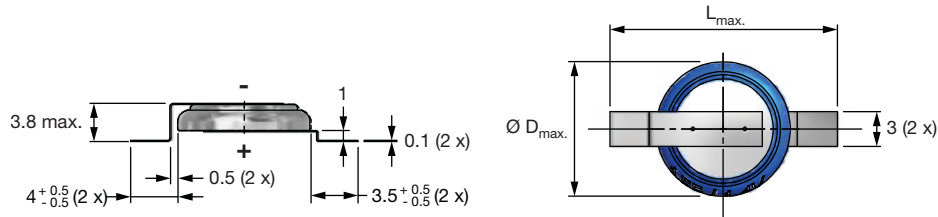

Fig. 4 - **Form C:** Surface Mount Flat (single cell, keyed polarity)

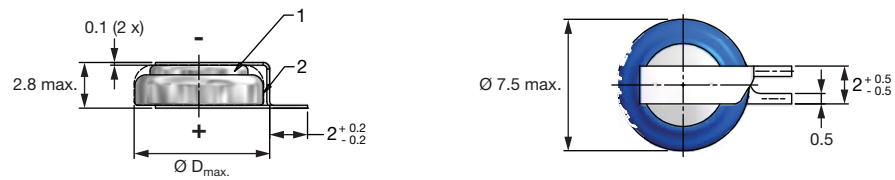

Fig. 5 - **Form D1:** Surface Mount Flat (single cell, keyed polarity)

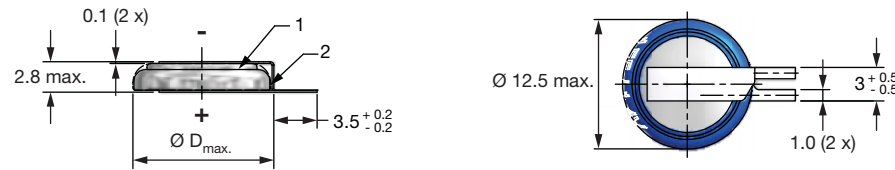

Fig. 6 - **Form D2:** Surface Mount Flat (single cell, keyed polarity)

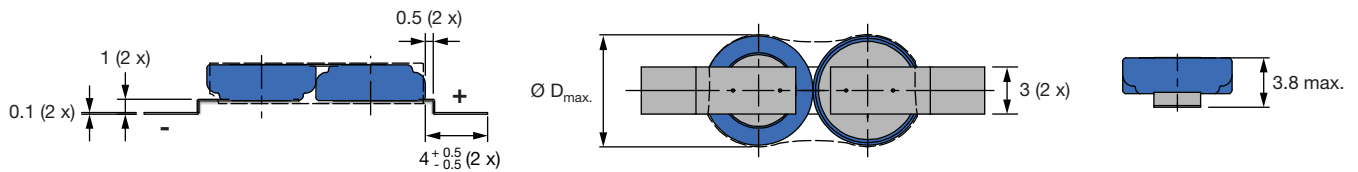

Fig. 7 - **Form E2:** Surface Mount Flat

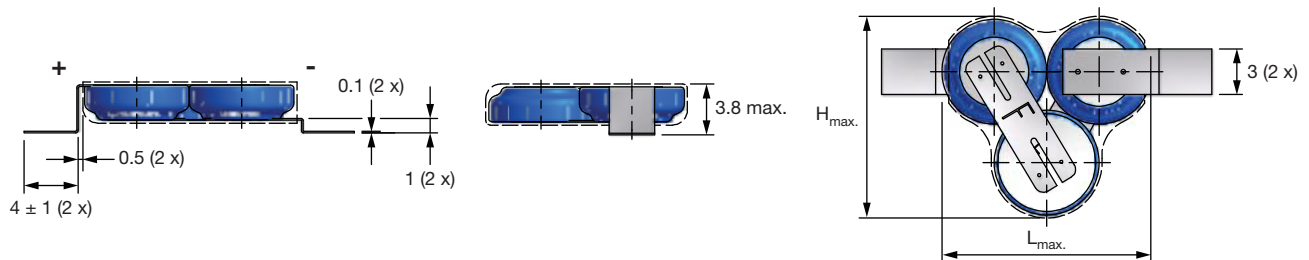

Fig. 8 - **Form E3:** Surface Mount Flat

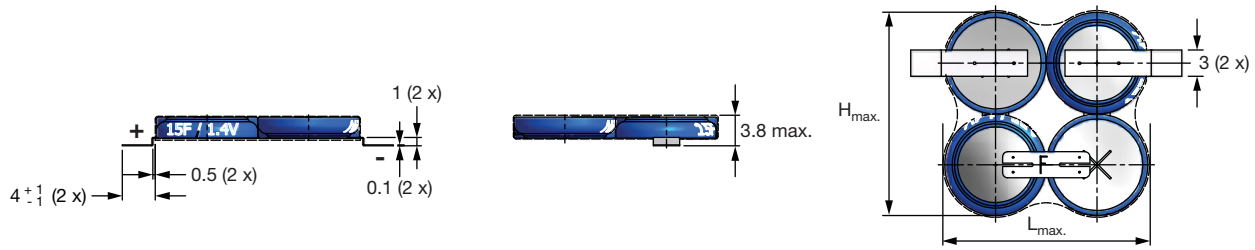

Fig. 9 - Form E4: Surface Mount Flat

**LAY FLAT CONFIGURATION (LFC) WITH CONNECTOR: Example 5 cells in series**

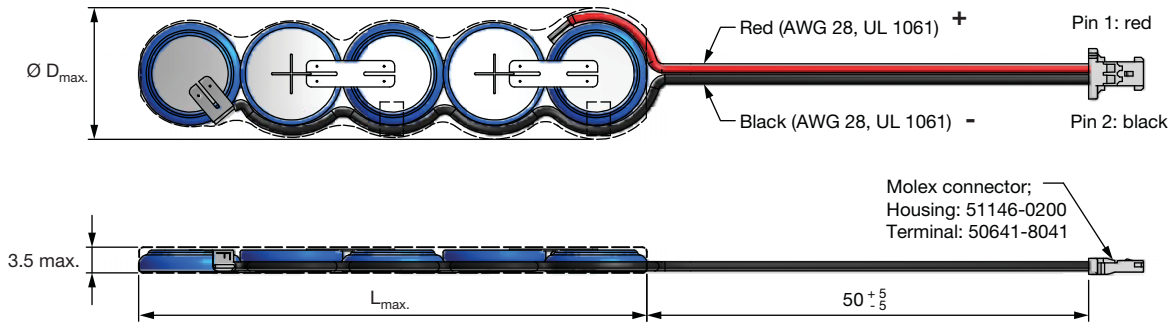

Fig. 10 - Form F: Lay Flat (example for 5 cells)

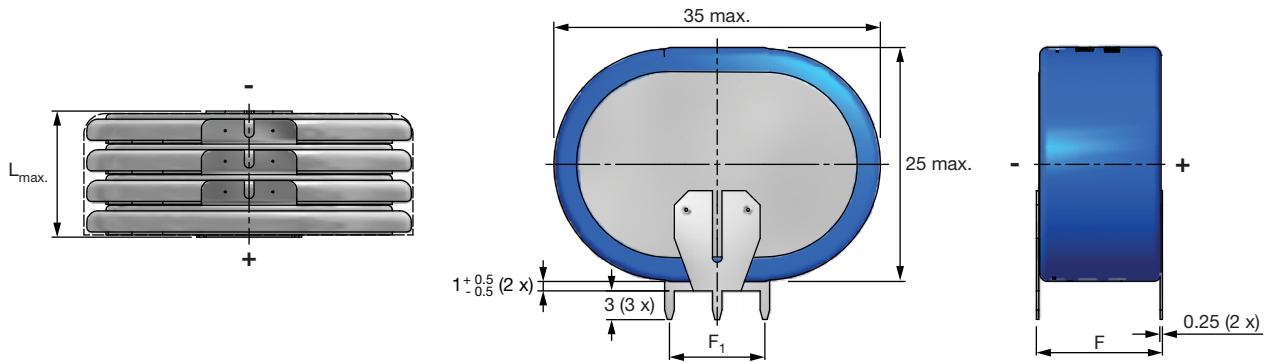

Fig. 11 - Form G: Stacked Through Hole Oval (PCBD)

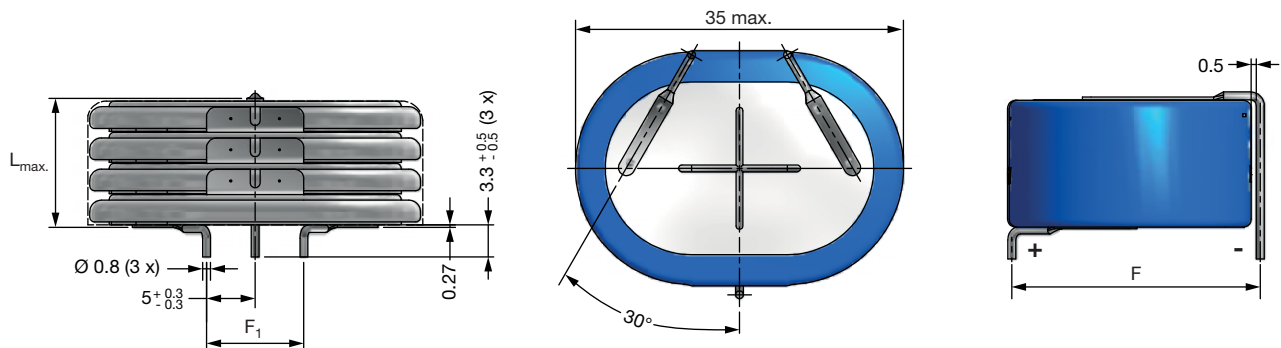

Fig. 12 - Form H: Stacked Through Hole Oval Horizontal



Table 1

<b>DIMENSIONS</b> in millimeters, <b>MASS AND PACKAGING QUANTITIES</b>						
<b>NOMINAL CASE SIZE</b> D x L x H (mm)	<b>FORM</b>	$\varnothing$ <b>D<sub>max.</sub></b>	<b>L<sub>max.</sub></b>	<b>L1<sub>max.</sub></b>	<b>H<sub>max.</sub></b>	<b>MASS</b> (g)
7.0 x 7.0 x 2.5	A2, B2, B3	7.5	2.3 + 0.3	7.0 + 0.5	-	0.5
7.0 x 7.0 x 2.5	C	7.5	7.0	7.0 + 8.0	-	0.5
7.0 x 7.0 x 2.5	D1	7.5	7.0	7.0 + 4.0	-	0.5
7.0 x 7.0 x 5.0	A2, B2, B3	7.5	4.2	4.2 + 0.5	-	0.8
7.0 x 7.0 x 7.5	A2, B2, B3	7.5	7.5	7.8 + 0.5	-	1.5
7.0 x 7.0 x 10.0	A2, B2, B3	7.5	10.5	10.2 + 0.5	-	1.8
7.0 x 7.0 x 12.5	A2, B2, B3	7.5	12.5	12.4 + 0.5	-	2.5
7.0 x 7.0 x 15.0	A2, B2, B3	7.5	14.8	14.8 + 0.5	-	3.0
12.0 x 12.0 x 2.5	A2, B2, B3	12.5	2.3	2.3 + 0.5	-	1.2
12.0 x 12.0 x 2.5	C	12.5	12.5	12.5 + 8.0	-	1.0
12.0 x 12.0 x 2.5	D2	12.5	12.5	12.5 + 4.0	-	1.0
12.0 x 12.0 x 5.0	A2, B2, B3	12.5	4.2	4.2 + 0.5	-	2.2
12.0 x 12.0 x 7.5	A2, B2, B3	12.5	8.0	7.8 + 0.5	-	3.3
12.0 x 12.0 x 10.0	A2, B2, B3	12.5	10.5	10.5 + 0.5	-	4.0
12.0 x 12.0 x 12.5	A2, B2, B3	12.5	12.5	12.5 + 0.5	-	5.4
12.0 x 12.0 x 15.0	A2, B2, B3	12.5	14.8	14.8 + 0.5	-	6.5
7.0 x 14.0 x 2.5	E2	7.5	14.8	14.8 + 8.0	-	1.0
12.0 x 24.0 x 2.5	E2	12.5	24.0	24.0 + 8.0	-	2.0
13.0 x 14.0 x 2.5	E3	14.0	15.0	14.8 + 8.0	14.0	1.2
22.0 x 24.0 x 2.5	E3	24.0	24.0	24.8 + 8.0	15.0	3.3
14.0 x 14.0 x 2.5	E4	15.0	15.0	14.8 + 8.0	22.5	1.5
24.0 x 24.0 x 2.5	E4	24.0	24.0	24.8 + 8.0	24.0	4.4
14.5 x 12.0 x 2.5	F	14.5	12.0	12.0 + 50.0	-	1.0
14.5 x 24.0 x 2.5	F	14.5	24.0	24.0 + 50.0	-	3.0
14.5 x 36.0 x 2.5	F	14.5	36.0	36.0 + 50.0	-	4.0
14.5 x 48.0 x 2.5	F	14.5	48.0	48.0 + 50.0	-	6.0
14.5 x 60.0 x 2.5	F	14.5	60.0	60.0 + 50.0	-	7.5
14.5 x 72.0 x 2.5	F	14.5	72.0	72.0 + 50.0	-	9.0
35 x 25 x 7.5	G, H	35 x 25	7.5	7.5 + 0.5	-	15.0
35 x 25 x 10.0	G, H	35 x 25	10.5	10.5 + 0.5	-	22.5
35 x 25 x 15.0	G, H	35 x 25	15.5	15.0 + 0.5	-	30.0

<b>ELECTRICAL DATA</b>	
<b>SYMBOL</b>	<b>DESCRIPTION</b>
C <sub>R</sub>	Rated capacitance, tolerance -20 %/+80 %, measured by constant current discharge method
UCT	Upper category temperature
I <sub>L</sub>	Max. leakage current after 24 h at U <sub>R</sub>
R <sub>I</sub>	Max. internal resistance at 1 kHz

**Note**

- Unless otherwise specified, all electrical values in Table 2 apply at T<sub>amb</sub> = 20 °C, P = 86 kPa to 106 kPa and RH = 45 % to 75 %.

**ORDERING EXAMPLE**

Hybrid Storage Capacitor

15 F/1.4 V

Nominal case size:  $\varnothing$  12.0 mm x 2.5 mm; Form B3

Ordering code: MAL219691211E3



Table 2

ELECTRICAL DATA AND ORDERING INFORMATION													
U <sub>R</sub> (V)	C <sub>R</sub> (µF)	NOMINAL CASE SIZE Ø D x L D x L x H (mm)	CASE CODE	FORM	F (mm)	F1 (mm)	UCT (°C)	I <sub>L</sub> 24 h (mA)	ESR AC <sup>(1)</sup> 1 kHz (Ω)	ESR DC <sup>(2)</sup> (Ω)	MIN. STORAGE ENERGY (Ws)	PACKAGING QUANTITIES	ORDERING CODE
<b>STACKED THROUGH HOLE CONFIGURATION (STH) - VERTICAL MOUNT</b>													
1.4	4 000 000	7.0 x 2.5	2 pin	A2	7.5	-	70	0.03	2.5	7.5	4.6	80	MAL219691101E3
2.8	4 000 000	7.0 x 5.0	2 pin	A2	7.5	-	70	0.03	5.0	15.0	9.2	80	MAL219691102E3
4.2	4 000 000	7.0 x 7.5	2 pin	A2	7.5	-	70	0.03	7.5	22.5	13.8	80	MAL219691103E3
5.6	4 000 000	7.0 x 10.0	2 pin	A2	7.5	-	70	0.03	10.0	30.0	18.4	80	MAL219691104E3
7.0	4 000 000	7.0 x 12.5	2 pin	A2	7.5	-	70	0.03	12.5	37.5	23.0	84	MAL219691105E3
8.4	4 000 000	7.0 x 15.0	2 pin	A2	7.5	-	70	0.03	15.0	45.0	27.6	84	MAL219691106E3
1.4	15 000 000	12.0 x 2.5	2 pin	A2	12.5	-	85	0.12	0.6	2.5	17.5	80	MAL219691201E3
2.8	15 000 000	12.0 x 5.0	2 pin	A2	12.5	-	85	0.12	1.2	5.0	35.0	80	MAL219691202E3
4.2	15 000 000	12.0 x 7.5	2 pin	A2	12.5	-	85	0.12	1.8	7.5	52.5	80	MAL219691203E3
5.6	15 000 000	12.0 x 10.0	2 pin	A2	12.5	-	85	0.12	2.4	10.0	70.0	80	MAL219691204E3
7.0	15 000 000	12.0 x 12.5	2 pin	A2	12.5	-	85	0.12	3.0	12.5	87.5	90	MAL219691205E3
8.4	15 000 000	12.0 x 15.0	2 pin	A2	12.5	-	85	0.12	3.6	15.0	105.0	90	MAL219691206E3
<b>STACKED THROUGH HOLE CONFIGURATION (STH) - HORIZONTAL MOUNT</b>													
1.4	4 000 000	7.0 x 2.5	2 pin	B2	3.2	-	70	0.03	2.5	7.5	4.6	100	MAL219691121E3
2.8	4 000 000	7.0 x 5.0	2 pin	B2	5.4	-	70	0.03	5.0	15.0	9.2	100	MAL219691122E3
4.2	4 000 000	7.0 x 7.5	2 pin	B2	7.5	-	70	0.03	7.5	22.5	13.8	96	MAL219691123E3
5.6	4 000 000	7.0 x 10.0	2 pin	B2	8.8	-	70	0.03	10.0	30.0	18.4	96	MAL219691124E3
7.0	4 000 000	7.0 x 12.5	2 pin	B2	12	-	70	0.03	12.5	37.5	23.0	40	MAL219691125E3
8.4	4 000 000	7.0 x 15.0	2 pin	B2	14.5	-	70	0.03	15.0	45.0	27.6	40	MAL219691126E3
1.4	15 000 000	12.0 x 2.5	2 pin	B2	3.2	-	85	0.12	0.6	2.5	17.5	100	MAL219691221E3
2.8	15 000 000	12.0 x 5.0	2 pin	B2	5.8	-	85	0.12	1.2	5.0	35.0	100	MAL219691222E3
4.2	15 000 000	12.0 x 7.5	2 pin	B2	8.3	-	85	0.12	1.8	7.5	52.5	80	MAL219691223E3
5.6	15 000 000	12.0 x 10.0	2 pin	B2	11.0	-	85	0.12	2.4	10.0	70.0	80	MAL219691224E3
7.0	15 000 000	12.0 x 12.5	2 pin	B2	13.4	-	85	0.12	3.0	12.5	87.5	40	MAL219691225E3
8.4	15 000 000	12.0 x 15.0	2 pin	B2	15.7	-	85	0.12	3.6	15.0	105.0	40	MAL219691226E3
1.4	4 000 000	7.0 x 2.5	3 pin	B3	2.8	2.5	70	0.03	2.5	7.5	4.6	100	MAL219691111E3
2.8	4 000 000	7.0 x 5.0	3 pin	B3	5.1	2.5	70	0.03	5.0	15.0	9.2	100	MAL219691112E3
4.2	4 000 000	7.0 x 7.5	3 pin	B3	7.5	2.5	70	0.03	7.5	22.5	13.8	88	MAL219691113E3
5.6	4 000 000	7.0 x 10.0	3 pin	B3	10.0	2.5	70	0.03	10.0	30.0	18.4	88	MAL219691114E3
7.0	4 000 000	7.0 x 12.5	3 pin	B3	12.0	2.5	70	0.03	12.5	37.5	23.0	40	MAL219691115E3
8.4	4 000 000	7.0 x 15.0	3 pin	B3	14.5	2.5	70	0.03	15.0	45.0	27.6	40	MAL219691116E3
1.4	15 000 000	12.0 x 2.5	3 pin	B3	3.2	5.0	85	0.12	0.6	2.5	17.5	100	MAL219691211E3
2.8	15 000 000	12.0 x 5.0	3 pin	B3	5.8	5.0	85	0.12	1.2	5.0	35.0	100	MAL219691212E3
4.2	15 000 000	12.0 x 7.5	3 pin	B3	8.0	5.0	85	0.12	1.8	7.5	52.5	80	MAL219691213E3
5.6	15 000 000	12.0 x 10.0	3 pin	B3	11.0	5.0	85	0.12	2.4	10.0	70.0	25	MAL219691214E3
7.0	15 000 000	12.0 x 12.5	3 pin	B3	13.0	5.0	85	0.12	3.0	12.5	87.5	40	MAL219691215E3
8.4	15 000 000	12.0 x 15.0	3 pin	B3	16.0	5.0	85	0.12	3.6	15.0	105.0	40	MAL219691216E3



**ELECTRICAL DATA AND ORDERING INFORMATION**

U <sub>R</sub> (V)	C <sub>R</sub> (μF)	NOMINAL CASE SIZE Ø D x L D x L x H (mm)	CASE CODE	FORM	F (mm)	F1 (mm)	UCT (°C)	I <sub>L</sub> 24 h (mA)	ESR AC <sup>(1)</sup> 1 kHz (Ω)	ESR DC <sup>(2)</sup> (Ω)	MIN. STORAGE ENERGY (Ws)	PACKAGING QUANTITIES	ORDERING CODE
<b>SURFACE MOUNT FLAT CONFIGURATION (SMF)</b>													
1.4	4 000 000	7.0 x 7.0 x 2.5	2 pin	C	-	-	70	0.03	2.5	7.5	4.6	100	MAL219691131E3
1.4	15 000 000	12.0 x 12.0 x 2.5	2 pin	C	-	-	85	0.12	0.6	2.5	17.5	100	MAL219691231E3
1.4	4 000 000	7.0 x 7.0 x 2.5	2 pin	D1	-	-	70	0.03	2.5	7.5	4.6	100	MAL219691141E3
1.4	15 000 000	12.0 x 12.0 x 2.5	2 pin	D2	-	-	85	0.12	0.6	2.5	17.5	100	MAL219691241E3
2.8	4 000 000	7.0 x 14.0 x 2.5	2 pin	E2	-	-	70	0.03	5.0	15.0	9.2	100	MAL219691152E3
2.8	15 000 000	12.0 x 24.0 x 2.5	2 pin	E2	-	-	85	0.12	1.2	5.0	35.0	50	MAL219691252E3
4.2	4 000 000	13.0 x 14.0 x 2.5	3 pin	E3	-	-	70	0.03	7.5	22.5	13.8	40	MAL219691153E3
4.2	15 000 000	22.0 x 24.0 x 2.5	3 pin	E3	-	-	85	0.12	1.8	7.5	52.5	40	MAL219691253E3
5.6	4 000 000	14.0 x 14.0 x 2.5	4 pin	E4	-	-	70	0.03	10.0	30.0	18.4	40	MAL219691154E3
5.6	15 000 000	24.0 x 24.0 x 2.5	4 pin	E4	-	-	85	0.12	2.4	10.0	70.0	40	MAL219691254E3
<b>LAY FLAT CONFIGURATION (LFC)</b>													
1.4	15 000 000	14.5 x 12.0 x 2.5	2 pin	F	-	-	85	0.12	0.6	2.5	17.5	40	MAL219691261E3
2.8	15 000 000	14.5 x 24.0 x 2.5	2 pin	F	-	-	85	0.12	1.2	5.0	35.0	40	MAL219691262E3
4.2	15 000 000	14.5 x 36.0 x 2.5	2 pin	F	-	-	85	0.12	1.8	7.5	52.5	40	MAL219691263E3
5.6	15 000 000	14.5 x 48.0 x 2.5	2 pin	F	-	-	85	0.12	2.4	10.0	70.0	20	MAL219691264E3
7.0	15 000 000	14.5 x 60.0 x 2.5	2 pin	F	-	-	85	0.12	3.6	12.5	87.5	20	MAL219691265E3
8.4	15 000 000	14.5 x 72.0 x 2.5	2 pin	F	-	-	85	0.12	4.8	15.0	105.0	20	MAL219691266E3
<b>STACKED THROUGH HOLE OVAL</b>													
2.8	90 000 000	35 x 25 x 7.5	3 pin	G	7	10	85	0.5	0.03	0.090	230.0	25	MAL219690103E3
4.2	90 000 000	35 x 25 x 10	3 pin	G	10	10	85	0.5	0.04	0.135	345.0	25	MAL219690101E3
5.6	90 000 000	35 x 25 x 15	3 pin	G	15	10	85	0.5	0.06	0.180	460.0	25	MAL219690102E3
<b>STACKED THROUGH HOLE OVAL HORIZONTAL</b>													
2.8	90 000 000	35 x 25 x 7.5	3 pin	H	25	10	85	0.5	0.03	0.090	230.0	25	MAL219690113E3
4.2	90 000 000	35 x 25 x 10	3 pin	H	25	10	85	0.5	0.04	0.135	345.0	25	MAL219690111E3
5.6	90 000 000	35 x 25 x 15	3 pin	H	25	10	85	0.5	0.06	0.180	460.0	25	MAL219690112E3

**Notes**

- <sup>(1)</sup> ESR AC 1 kHz are typical values.
- <sup>(2)</sup> ESR DC are typical values.

**Table 3**

<b>LOAD CURRENTS AND VOLTAGES</b>				
C <sub>R</sub> (μF)	RECOMMENDED CHARGE CURRENT	MAX. CHARGE CURRENT	MAX. DISCHARGE CURRENT	LOWEST DISCHARGE VOLTAGE <sup>(1)</sup>
4 000 000	2 mA to 8 mA	14 mA	25 mA	n x 0.8 V
15 000 000	5 mA to 20 mA	50 mA	70 mA	n x 0.8 V
90 000 000	0.3 A to 1 A	1.5 A	3 A	n x 0.8 V

**Note**

- <sup>(1)</sup> n... number of cells, permanent operation below lowest discharge voltage is not permitted.

**MEASURING OF CHARACTERISTICS**

**CAPACITANCE (C)**

Capacitance shall be measured by constant current discharge method.

DISCHARGE CURRENT AS A FUNCTION OF RATED CAPACITANCE				
PARAMETER	VALUE			UNIT
Rated capacitance, C <sub>R</sub>	4	15	90	F
Discharge current, I <sub>D</sub>	4	15	90	mA

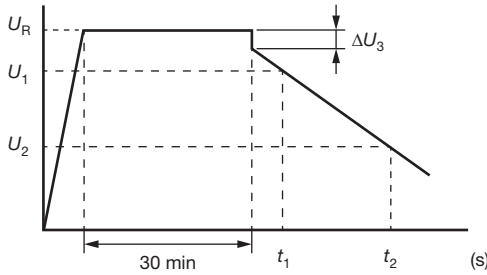

Fig. 13 - Voltage Diagram for Capacitance Measurement

Capacitance value C<sub>R</sub> is given by discharge current I<sub>D</sub>, time t and rated voltage U<sub>R</sub>, according to the following equation:

- C<sub>R</sub> Rated capacitance, in F
- U<sub>R</sub> Rated voltage, in V
- U<sub>1</sub> Starting voltage, in V
- U<sub>2</sub> Ending voltage, in V
- ΔU<sub>3</sub> Voltage drop at internal resistance, in V
- t<sub>1</sub> Time from start of discharge until voltage U<sub>1</sub> is reached, in s
- t<sub>2</sub> Time from start of discharge until voltage U<sub>2</sub> is reached, in s
- I<sub>D</sub> Discharge current, in A

$$C_R(F) = \frac{I_D(A) \times (t_2(s) - t_1(s))}{U_1(V) - U_2(V)}$$

For I<sub>D</sub>, U<sub>1</sub>, and U<sub>2</sub> the following definitions have to be used:

**Table 4**

CAPACITANCE						
C (F)	I <sub>D</sub> (A)	U <sub>R</sub> (V)	U <sub>1</sub> (V)	U <sub>2</sub> (V)	t <sub>1</sub> (s)	t <sub>2</sub> (s)
4	0.004	1.4	1.3	0.7	5	> 600
4	0.004	2.8	2.7	1.9	5	> 600
4	0.004	4.2	4.0	3.1	5	> 600
4	0.004	5.6	5.4	4.4	5	> 600
4	0.004	7.0	6.7	5.6	5	> 600
4	0.004	8.4	8.1	6.9	5	> 600
15	0.015	1.4	1.3	0.7	5	> 600
15	0.015	2.8	2.7	1.9	5	> 600
15	0.015	4.2	4.0	3.1	5	> 600
15	0.015	5.6	5.4	4.4	5	> 600
15	0.015	7.0	6.7	5.6	5	> 600
15	0.015	8.4	8.1	6.9	5	> 600
90	0.090	2.8	2.7	1.9	5	> 600
90	0.090	4.2	4.0	3.1	5	> 600
90	0.090	5.6	5.4	4.4	5	> 600

**Note**

- For U<sub>2</sub> see also Table 5.

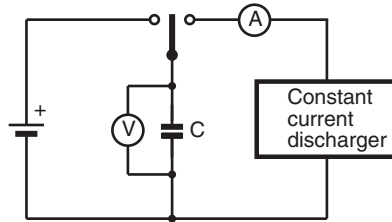

Fig. 14 - Test Circuit for Capacitance Measurement

**INTERNAL RESISTANCE (R<sub>I</sub>) AT 1 kHz**

$$R_I(\Omega) = \frac{U_C(V)}{10^{-3}}$$

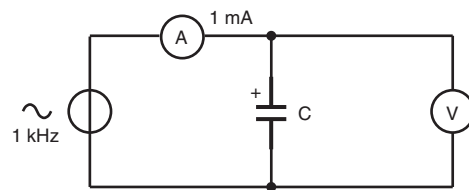

Fig. 15 - Test Circuit for R<sub>I</sub> Measurement

**LEAKAGE CURRENT (I<sub>L</sub>)**

Leakage current shall be measured after 30 min application of rated voltage U<sub>R</sub>:

$$I_L(\mu A) = \frac{U_S(V)}{10^{-4}}$$

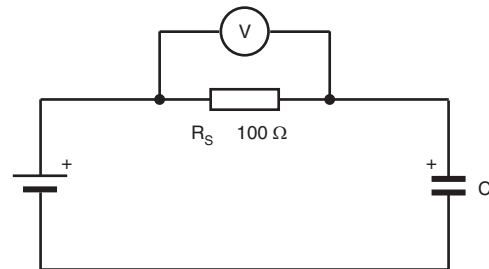

Fig. 16 - Test Circuit for Leakage Current

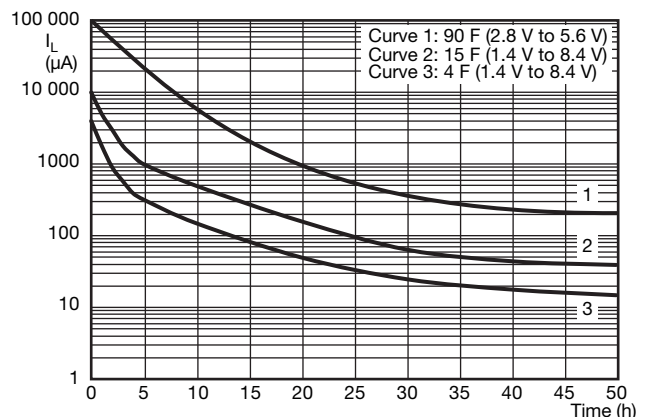

Fig. 17 - Typical Leakage Current at R<sub>T</sub> as a Function of Time





Table 5

VOLTAGE TO BE USED FOR SERIES CONNECTION			
N CELLS IN SERIES	U <sub>R</sub> (V)	U <sub>1</sub> (V)	U <sub>2</sub> (V)
1	1.4	1.3	0.7
2	2.8	2.7	1.9
3	4.2	4.0	3.1
4	5.6	5.4	4.4
5	7.0	6.7	5.6
6	8.4	8.1	6.9

**DISCHARGE CHARACTERISTICS**

Backup time of 196 HVC series capacitors depends on minimum memory holding voltage and discharge current (corresponding with the current consumption of the load).

For minimum backup times of standard and vertical miniaturized series see figure 18 to figure 20 (charging time ≥ 24 h and CC-CV charging according to table 3).

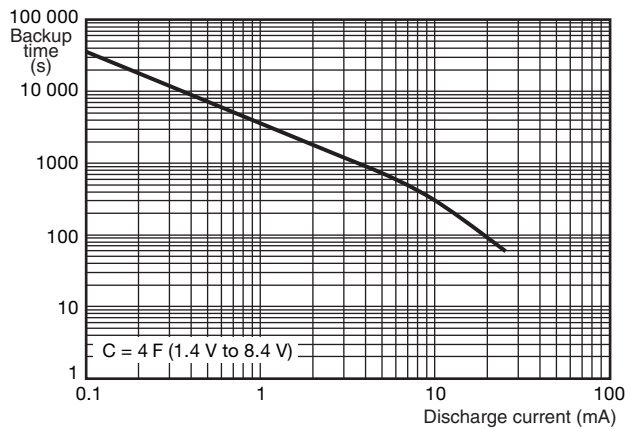

Fig. 18 - Typical Backup Time as a Function of Discharge Current

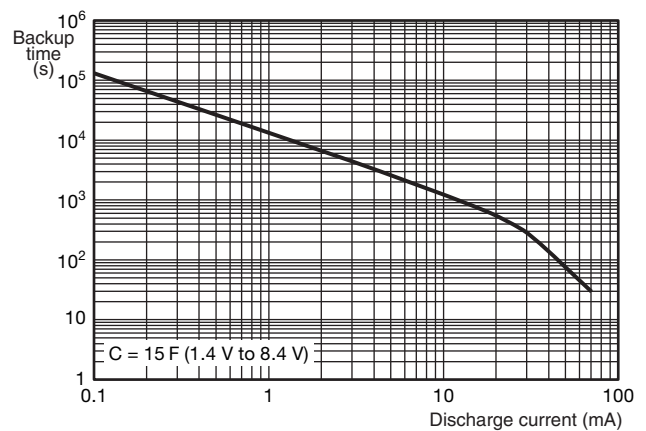

Fig. 19 - Typical Backup Time as a Function of Discharge Current

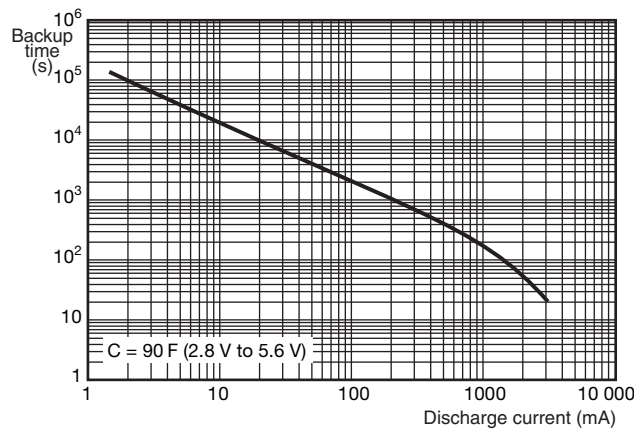

Fig. 20 - Typical Backup Time as a Function of Discharge Current



CHARGE CHARACTERISTICS

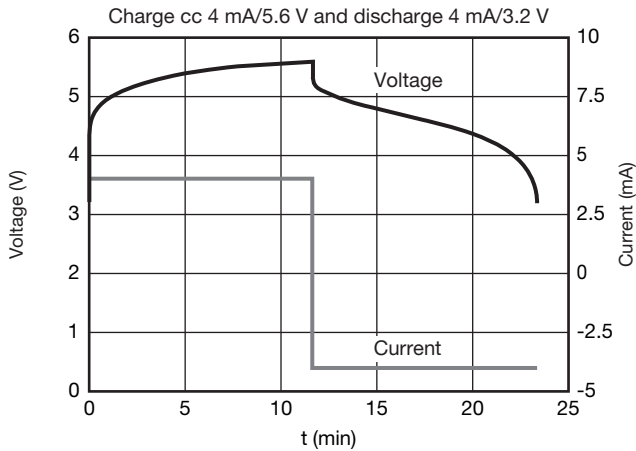

Fig. 21 - Constant Current (CC) with V-Limit Charging Method at RT  
Typical Charge/Discharge Characteristics at RT: 4 F/5.6 V

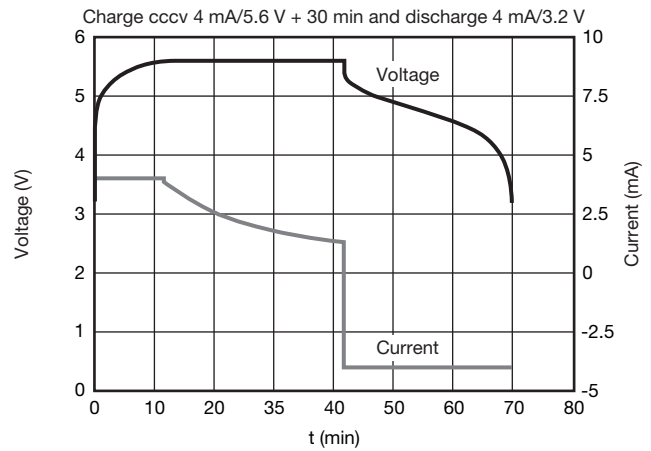

Fig. 22 - Constant Current (CC)-Constant Voltage (CV)  
Charging Method at RT  
Typical Charge/Discharge Characteristics at RT: 4 F/5.6 V

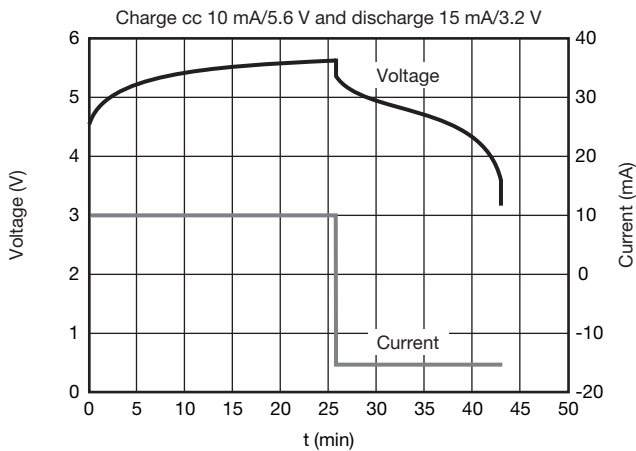

Fig. 23 - Constant Current (CC) with V-Limit Charging Method at RT  
Typical Charge/Discharge Characteristics at RT: 15 F/5.6 V

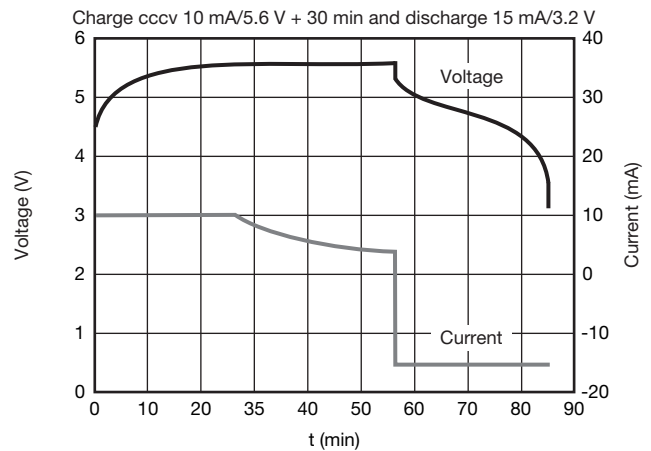

Fig. 24 - Constant Current (CC)-Constant Voltage (CV)  
Charging Method at RT  
Typical Charge/Discharge Characteristics at RT: 15 F/5.6 V

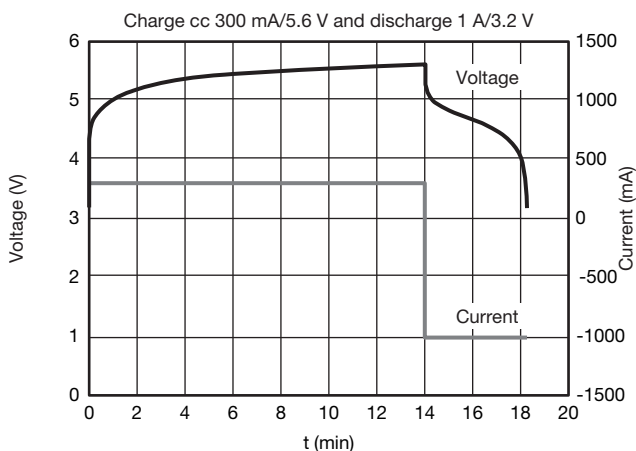

Fig. 25 - Constant Current (CC) with V-Limit Charging Method at RT  
Typical Charge/Discharge Characteristics at RT: 90 F/5.6 V

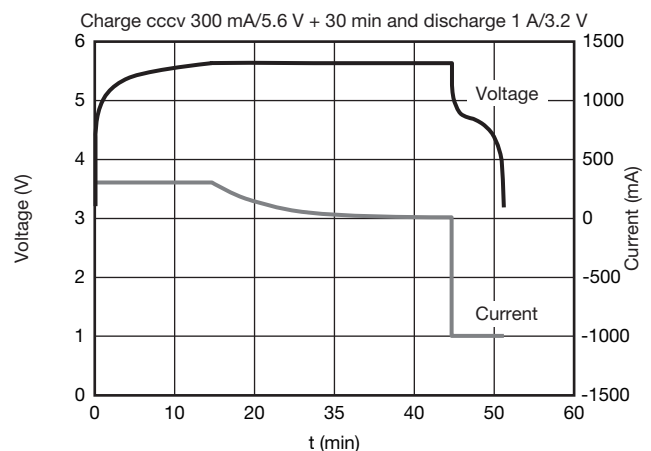

Fig. 26 - Constant Current (CC)-Constant Voltage (CV)  
Charging Method at RT  
Typical Charge/Discharge Characteristics at RT: 90 F/5.6 V

Note

- Charge and discharge cycles at room temperature - maximal 50 000 cycles at room temperature allowed!



CHARGING VOLTAGE AT DIFFERENT TEMPERATURES				
OPERATING TEMPERATURE RANGE	0 °C UP TO +45 °C		+45 °C UP TO +60 °C	+60 °C UP TO +70 °C/+85 °C
Charge voltage	1 cell	$U_R + 0.03 \text{ V}$	$U_R$	$U_R - n^{(1)} \times 0.0015 \times (T[°C] - 45)$
	2 cells	$U_R + 0.06 \text{ V}$		
	3 cells	$U_R + 0.09 \text{ V}$		
	> 4 cells	$U_R + 0.10 \text{ V}$		

**Notes**

- Capacitor is polarized, product will be damaged if reverse charged.
- Voltages higher than specified need to be avoided; otherwise reduction of life time, internal gas generation or damage of HVC hybrid capacitor will occur.
- For other operating temperatures, a temperature derating factor has to be considered for correct charging voltage.
- Surge voltage is only allowed a few seconds per day, but not as a charging process.

<sup>(1)</sup> n... number of cells

**DERATING**

Working voltage at temperatures above 60 °C should be below rated voltage  $U_R$ . A derating-factor of -1.5 mV/°C per cell is recommended.

**PRODUCT AND MOUNTING CHARACTERISTICS**

**Attention: parts are pre-charged at delivery - handle appropriate.**

At delivery products are pre-charged and voltage over terminals is near nominal voltage. Short circuiting of product terminals is permitted. Do not short circuit permanently. Short circuiting of charged cells may heat up the cells. Cells will fulfill UL 2054 -  $T_{\text{cell}} < 150 \text{ °C}$  due to self heating in case of short circuiting.

For printed circuit board mounting it has to be taken into account, that for certain form factors top and bottom of products may not be insulated.

Capacitor disposal methods should be in accordance with local and state regulations.

**Table 6.1**

TEST PROCEDURES AND REQUIREMENTS			
NAME OF TEST	IEC 60384-4/ EN 130300 SUBCLAUSE	PROCEDURE (quick reference)	REQUIREMENTS
Damp heat, steady state	4.12	500 h at 55 °C; RH 90 % to 95 %; no voltage applied	$\Delta C/C: \pm 30 \%$ $R_I \leq 4 \times \text{spec. limit}$ $I_L \leq 2 \times \text{spec. limit}$
Endurance	4.13	$T_{\text{amb}} = 70 \text{ °C} / 85 \text{ °C}$ ; rated voltage $U_R$ applied; 1000 h	$\Delta C/C: \pm 30 \%$ $R_I \leq 4 \times \text{spec. limit}$ $I_L \leq 2 \times \text{spec. limit}$
Shelf at upper category temperature	4.17	$T_{\text{amb}} = 70 \text{ °C} / 85 \text{ °C}$ ; no voltage applied; 1000 h	$\Delta C/C: \pm 30 \%$ $R_I \leq 4 \times \text{spec. limit}$ $I_L \leq 2 \times \text{spec. limit}$
Shelf discharge	-	24 h storage at room temperature after application of $n \times U_R$	Remaining voltage: $\geq n \times (U_R \times 0.1)$
Characteristics at high and low temperature	4.19	Step 1: reference measurement at 20 °C of C, $R_I$ , and $I_L$ Step 2: measurement at -20 °C Step 3: measurement at +20 °C Step 2: measurement at +70 °C Step 4: measurement at +20 °C	$\Delta C/C: \pm 30 \%$ of +20 °C value $R_I \leq 5 \times \text{the } +20 \text{ °C value}$ $I_L \leq 4 \times \text{the } +20 \text{ °C value}$
Surge voltage	-	Max. 30 s at room temperature $U_S = n^{(1)} \times 1.6 \text{ V}$	No change of parameter! After surge voltage, discharge product below rated voltage

**Note**

<sup>(1)</sup> n... number of cells



Table 6.2: Stacked Through Hole configuration (STH), Surface Mount Flat configuration (SMF), and Lay Flat configuration with Connector

TEST PROCEDURES AND REQUIREMENTS			
NAME OF TEST	IEC 60384-4/ EN 130300 SUBCLAUSE	PROCEDURE (quick reference)	REQUIREMENTS
Robustness of terminations	4.4	Tensile strength; application of load force for 10 s: 20 N (standard series) 5 N (vertical miniaturized series)	No breaks
Resistance to soldering heat	4.5	Solder bath; 260 °C; 5 s	$\Delta C/C: \pm 10 \%$ $R_I$ and $I_L \leq \text{spec. limit}$
Solderability	4.6	Solder bath; 236 °C; 2 s	$\geq 75 \%$ tinning
Vibration	4.8	10 Hz to 55 Hz; 1.5 mm; 3 directions; 2 h per direction	$\Delta C/C: \pm 10 \%$ $R_I$ and $I_L \leq \text{spec. limit}$

Notes

- Robustness - bending limited to  $\pm 15^\circ$ , force in direction of tab.
- Solder bath test: max. allowed case temperature during test is e.g. 85 °C or immersion of one (1) pad only.
- Wave soldering allowed.

SOLDERING

As a general principle, temperature and duration shall be the minimum necessary required to ensure good soldering connections. However, the maximum specified soldering time and case temperature should never be exceeded.

EVALUATION KIT

Evaluation kits are available under ordering code: MAL219699001E3. The engineering kit includes a charge and discharge demo board with different 196 HVC capacitor samples.

For further details, please contact [aluminumcaps1@vishay.com](mailto:aluminumcaps1@vishay.com).



## Disclaimer

ALL PRODUCT, PRODUCT SPECIFICATIONS AND DATA ARE SUBJECT TO CHANGE WITHOUT NOTICE TO IMPROVE RELIABILITY, FUNCTION OR DESIGN OR OTHERWISE.

Vishay Intertechnology, Inc., its affiliates, agents, and employees, and all persons acting on its or their behalf (collectively, "Vishay"), disclaim any and all liability for any errors, inaccuracies or incompleteness contained in any datasheet or in any other disclosure relating to any product.

Vishay makes no warranty, representation or guarantee regarding the suitability of the products for any particular purpose or the continuing production of any product. To the maximum extent permitted by applicable law, Vishay disclaims (i) any and all liability arising out of the application or use of any product, (ii) any and all liability, including without limitation special, consequential or incidental damages, and (iii) any and all implied warranties, including warranties of fitness for particular purpose, non-infringement and merchantability.

Statements regarding the suitability of products for certain types of applications are based on Vishay's knowledge of typical requirements that are often placed on Vishay products in generic applications. Such statements are not binding statements about the suitability of products for a particular application. It is the customer's responsibility to validate that a particular product with the properties described in the product specification is suitable for use in a particular application. Parameters provided in datasheets and/or specifications may vary in different applications and performance may vary over time. All operating parameters, including typical parameters, must be validated for each customer application by the customer's technical experts. Product specifications do not expand or otherwise modify Vishay's terms and conditions of purchase, including but not limited to the warranty expressed therein.

Except as expressly indicated in writing, Vishay products are not designed for use in medical, life-saving, or life-sustaining applications or for any other application in which the failure of the Vishay product could result in personal injury or death. Customers using or selling Vishay products not expressly indicated for use in such applications do so at their own risk. Please contact authorized Vishay personnel to obtain written terms and conditions regarding products designed for such applications.

No license, express or implied, by estoppel or otherwise, to any intellectual property rights is granted by this document or by any conduct of Vishay. Product names and markings noted herein may be trademarks of their respective owners.

## Material Category Policy

**Vishay Intertechnology, Inc. hereby certifies that all its products that are identified as RoHS-Compliant fulfill the definitions and restrictions defined under Directive 2011/65/EU of The European Parliament and of the Council of June 8, 2011 on the restriction of the use of certain hazardous substances in electrical and electronic equipment (EEE) - recast, unless otherwise specified as non-compliant.**

**Please note that some Vishay documentation may still make reference to RoHS Directive 2002/95/EC. We confirm that all the products identified as being compliant to Directive 2002/95/EC conform to Directive 2011/65/EU.**

**Vishay Intertechnology, Inc. hereby certifies that all its products that are identified as Halogen-Free follow Halogen-Free requirements as per JEDEC JS709A standards. Please note that some Vishay documentation may still make reference to the IEC 61249-2-21 definition. We confirm that all the products identified as being compliant to IEC 61249-2-21 conform to JEDEC JS709A standards.**



Компания «ЭлектроПласт» предлагает заключение долгосрочных отношений при поставках импортных электронных компонентов на взаимовыгодных условиях!

Наши преимущества:

- Оперативные поставки широкого спектра электронных компонентов отечественного и импортного производства напрямую от производителей и с крупнейших мировых складов;
- Поставка более 17-ти миллионов наименований электронных компонентов;
- Поставка сложных, дефицитных, либо снятых с производства позиций;
- Оперативные сроки поставки под заказ (от 5 рабочих дней);
- Экспресс доставка в любую точку России;
- Техническая поддержка проекта, помощь в подборе аналогов, поставка прототипов;
- Система менеджмента качества сертифицирована по Международному стандарту ISO 9001;
- Лицензия ФСБ на осуществление работ с использованием сведений, составляющих государственную тайну;
- Поставка специализированных компонентов (Xilinx, Altera, Analog Devices, Intersil, Interpoint, Microsemi, Aeroflex, Peregrine, Syfer, Eurofarad, Texas Instrument, Miteq, Cobham, E2V, MA-COM, Hittite, Mini-Circuits, General Dynamics и др.);

Помимо этого, одним из направлений компании «ЭлектроПласт» является направление «Источники питания». Мы предлагаем Вам помощь Конструкторского отдела:

- Подбор оптимального решения, техническое обоснование при выборе компонента;
- Подбор аналогов;
- Консультации по применению компонента;
- Поставка образцов и прототипов;
- Техническая поддержка проекта;
- Защита от снятия компонента с производства.



#### Как с нами связаться

**Телефон:** 8 (812) 309 58 32 (многоканальный)

**Факс:** 8 (812) 320-02-42

**Электронная почта:** [org@eplast1.ru](mailto:org@eplast1.ru)

**Адрес:** 198099, г. Санкт-Петербург, ул. Калинина, дом 2, корпус 4, литера А.