

PJB Open Frame Power Supply

24V 150W 1 Phase / PJB-24V150W□□A

PJB

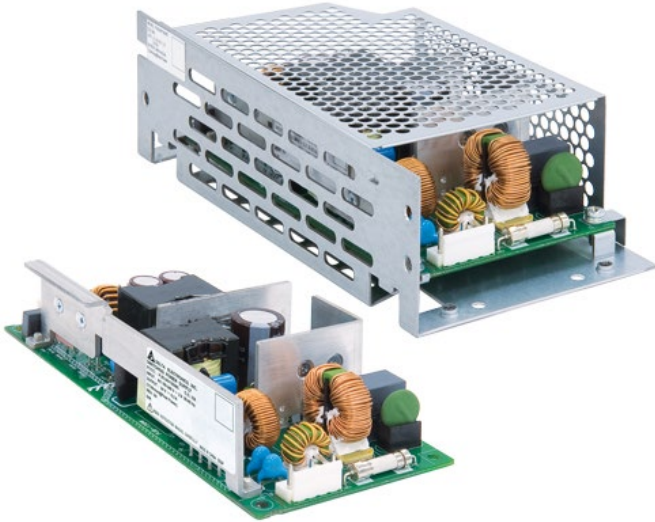

Highlights & Features

- Universal AC Input (85Vac – 264Vac)
 - Power Boost of 200% for 10 seconds
 - Low Inrush Current / Low Leakage Current
 - High efficiency and PF factor to conserve energy
 - Conformal coating on PCBA to protect against chemical and dust pollutants
 - Remote ON/OFF (Optional)
 - No Load power consumption < 0.5W (Optional)
 - Versatile configuration options: Open Frame, L Frame, Enclosed
 - Design compliance with Japan PSE (DENAN)*
- * For PJB-24V150W□□A/H□□A/G□□A models only

Safety Standards



CB Certified for worldwide use

Model Number: PJB-24V150W□□A
Unit Weight: **Open Frame:** 0.31 kg (0.68 lb)
Enclosed: 0.51 kg (2.00 lb)
Dimensions (L x W x D):
Open Frame: 160 x 75 x 37 mm (6.30 x 2.95 x 1.46 inch)
Enclosed: 188 x 85 x 47 mm (7.40 x 3.35 x 1.85 inch)

General Description

The PJB series of Open Frame Power Supply comes with universal AC input at 85Vac to 264Vac. Features are including low leakage / Inrush current and conformal coating on the PCBAs to provide protection against dust and chemical pollutants and low power consumption for optional. The built-in active PFC provides PF > 0.97 and fulfills Harmonic Current Emission according to IEC/EN 61000-3-2. The feature built-in Power Boost of 200% for 10 seconds enables reserve power to be always available for reliable startup of loads with high inrush current, thus eliminating the need of a more expensive power supply unit at higher power rating. Metal chassis and case cover are available as options for different installation preferences.

Model Information

PJB Open Frame Power Supply

Model Number	Input Voltage Range	Rated Output Voltage	Rated Output Current
PJB-24V150W□□A	85-264Vac	24Vdc	6.30A

Model Numbering

				CC Code	
PJB –	24V	150W	□	□	A
PJB Series	Output Voltage	Output Power	Package Type B - Open Frame L - L Frame C - Enclosed J - Open Frame + Green Mode H - L Frame + Green Mode G – Enclosed + Green Mode	Remote ON/OFF Function N - No Remote ON/OFF R - With Remote ON/OFF	Delta Standard



PJB Open Frame Power Supply

24V 150W 1 Phase / PJB-24V150W□□A

Specifications

Input Ratings / Characteristics

Nominal Input Voltage	100-240Vac	
Input Voltage Range	85-264Vac	
Nominal Input Frequency	50-60Hz	
Input Frequency Range	47-63Hz	
Input Current	1.90A typ. @ 100Vac, 0.95A typ. @ 200Vac	
Efficiency at 100% Load	88.0% typ. @ 100Vac, 90.5% typ. @ 200Vac	
No Load Power Consumption	Package Type : B \ L \ C	3.5W typ.
	Package Type : J \ H \ G	< 0.5W @100Vac & 200Vac
Max Inrush Current (Cold Start)	15A typ. @ 100Vac, 30A typ. @ 200Vac	
Power Factor Correction at 100% load	0.98 typ. @ 100Vac, 0.95 typ. @ 200Vac	
Leakage Current	0.2mA @ 100Vac, 0.4mA @ 240Vac	

Output Ratings / Characteristics*

Nominal Output Voltage	24Vdc
Factory Set point Tolerance	24Vdc \pm 1% (initial set point tolerance from factory)
Output Voltage Adjustment Range	21.6-26.4Vdc
Output Current	6.30A (continuously operating at 24V) 12.6A (Power Boost for 10 seconds at 24V, refer to the details in the Functions section)
Output Power	151.2W (continuously operating at 24V) 302.4W (Power Boost for 10 seconds at 24V, refer to the details in the Functions section)
Line Regulation	< 96mV
Load Regulation	< 150mV
Ripple (20MHz)	< 150mVpp @ 0°C to 50°C, < 180mVpp @ -10°C to 0°C
Ripple Noise (20MHz)	< 150mVpp @ 0°C to 50°C, < 180mVpp @ -10°C to 0°C
Start-up Time	500ms typ. @ 100Vac (100% load)
Hold-up Time	20ms typ. @ 100Vac (100% load)
Dynamic Response (Overshoot & Undershoot O/P Voltage)	\pm 5% @ 0-50% load and 50-100% load (Slew Rate: 0.1A/ μ S)
Start-up with Capacitive Loads	8,000 μ F Max

*For power de-rating from 50°C to 70°C, see power de-rating on page 3

Mechanical

Case Chassis/Cover	SGCC
Dimensions	Open Frame 160 x 75 x 37 mm (6.30 x 2.95 x 1.46 inch)
Unit Weight	Open Frame 0.31 kg (0.68 lb)
	Enclosed 0.51 kg (2.00 lb)
Indicator	NA
Cooling System	Convection
Terminal	Input JST B3P5-VH (LF)(SN)
	Output V-: JST B7P-VH (LF)(SN), V+: JST B6P-VH (LF)(SN)
Wire	AWG 22-18
Noise (1 Meter from power supply)	Sound Pressure Level (SPL) < 25dBA

PJB Open Frame Power Supply

24V 150W 1 Phase / PJB-24V150W□□A

Environment

Surrounding Air Temperature	Operating	-10°C to +70°C
	Storage	-25°C to +75°C
Power De-rating	Mounting Orientation A	> 50°C de-rate power by 2% / °C < 90Vac de-rate power by 2% / V
Operating Humidity		5 to 95% RH (Non-Condensing)
Operating Altitude		0 to 5,000 Meters (16,400 ft)
Shock Test	Non-Operating	IEC 60068-2-27, Half Sine Wave: 50G for a duration of 11ms, 3 shocks for each 3 directions
Vibration	Operating	IEC 60068-2-6, Sine Wave: 10Hz to 55Hz @ 19.6m/S ² (2G peak); 10 min per cycle, 60 min per axis for all X, Y, Z direction
Over Voltage Category		2
Pollution Degree		2

Protections

Overvoltage	27.6-33.6V, Latch Mode
Overload / Overcurrent	> 220% of rated load current, Hiccup Mode, Non-Latching (Auto-Recovery)
Over Temperature	Latch Mode
Short Circuit	Hiccup Mode, Non-Latching (Auto-Recovery when the fault is removed)
Protection Against Shock	Class I with PE* connection

*PE: Primary Earth

Reliability Data

MTBF	> 200,000 hrs. as per JEITA RCR-9102B
Expected Cap Life Time	10 years (115Vac, 50% load @ 40°C)

Safety Standards / Directives

Safety Entry Low Voltage	SELV (EN 60950-1)	
Electrical Safety	<p>TUV Bauart UL/cUL recognized</p> <p>CCC CB scheme</p> <p>For Package type : B / L / C EN 60950-1 UL 60950-1 and CSA C22.2 No. 60950-1 (File No. E131881) CCC GB4943.1-2011 IEC 60950-1</p>	
	<p>UL/cUL recognized</p> <p>CCC CB scheme</p> <p>For Package type : J / H / G UL 60950-1 and CSA C22.2 No. 60950-1 (File No. E131881) CCC GB4943.1-2011 IEC/UL/EN 62368-1 Design to meet DENAN at 100Vac - 240Vac</p>	
CE	In conformance with EMC Directive 2014/30/EU & EU/2015/863 and Low Voltage Directive 2014/35/EU	
Material and Parts	RoHS Directive 2011/65/EU Compliant	
Galvanic Isolation	Input to Output	3.0KVac
	Input to Ground	2.0KVac
	Output to Ground	0.5KVac

PJB Open Frame Power Supply

24V 150W 1 Phase / PJB-24V150W□□A

EMC

Emissions (CE&RE)		CISPR 32, EN 55032, FCC Title 47: Class B
Immunity		EN61000-6-1 (For Package Type : B · L · C)
Electrostatic Discharge	IEC 61000-4-2	Criteria A ¹⁾ Air Discharge: 8kV (Level 3) Contact Discharge: 4kV (Level 2)
Radiated Field	IEC 61000-4-3	Level 2 Criteria A ¹⁾ 80MHz-1GHz, 3V/M with 1kHz tone / 80% modulation
Electrical Fast Transient / Burst	IEC 61000-4-4	Level 2 Criteria A ¹⁾ 1kV
Surge	IEC 61000-4-5	Level 3 Criteria A ¹⁾ Common Mode ⁴⁾ : 2kV Differential Mode ⁵⁾ : 1kV
Conducted	IEC 61000-4-6	Level 2 Criteria A ¹⁾ 150kHz-80MHz, 3Vrms
Power Frequency Magnetic Fields	IEC 61000-4-8	Criteria A ¹⁾ Magnetic field strength 1A/Meter
Voltage Dips and Interruptions	IEC 61000-4-11	100% dip; 1 cycle (20ms); Self Recoverable
Immunity		EN61000-6-2 (For Package Type : G · H · J)
Electrostatic Discharge	IEC 61000-4-2	Level 4 Criteria A ¹⁾ Air Discharge: 15kV Contact Discharge: 8kV
Radiated Field	IEC 61000-4-3	Level 3 Criteria A ¹⁾ 80MHz-1GHz, 10V/M with 1kHz tone / 80% modulation
Electrical Fast Transient / Burst	IEC 61000-4-4	Level 3 Criteria A ¹⁾ 4kV
Surge	IEC 61000-4-5	Level 4 Criteria A ¹⁾ Common Mode ⁴⁾ : 4kV Differential Mode ⁵⁾ : 2kV
Conducted	IEC 61000-4-6	Level 3 Criteria A ¹⁾ 150kHz-80MHz, 10Vrms
Power Frequency Magnetic Fields	IEC 61000-4-8	Level 4 Criteria A ¹⁾ Magnetic field strength 30A/Meter
Voltage Dips and Interruptions	IEC 61000-4-11	100% dip; 1 cycle, Criteria B ²⁾ 40% dip; 10 cycle, Criteria C ³⁾ 70% dip; 25 cycle, Criteria C ³⁾ 100% dip; 250 cycle, Criteria C ³⁾
Harmonic Current Emission		IEC/EN 61000-3-2, Class A
Voltage Fluctuation and Flicker		IEC/EN 61000-3-3

1) Criteria A: Normal performance within the specification limits

2) Criteria B: Output out of regulation, or shuts down during test. Automatically restored to normal operation after test.

3) Criteria C: Output out of regulation, shuts down during test (Need to recycle AC power cord to normal operation after test)

4) Asymmetrical: Common mode (Line to earth)

5) Symmetrical: Differential mode (Line to line)

PJB Open Frame Power Supply

24V 150W 1 Phase / PJB-24V150W□□A

Block Diagram(For Package Type : B 、 L 、 C)

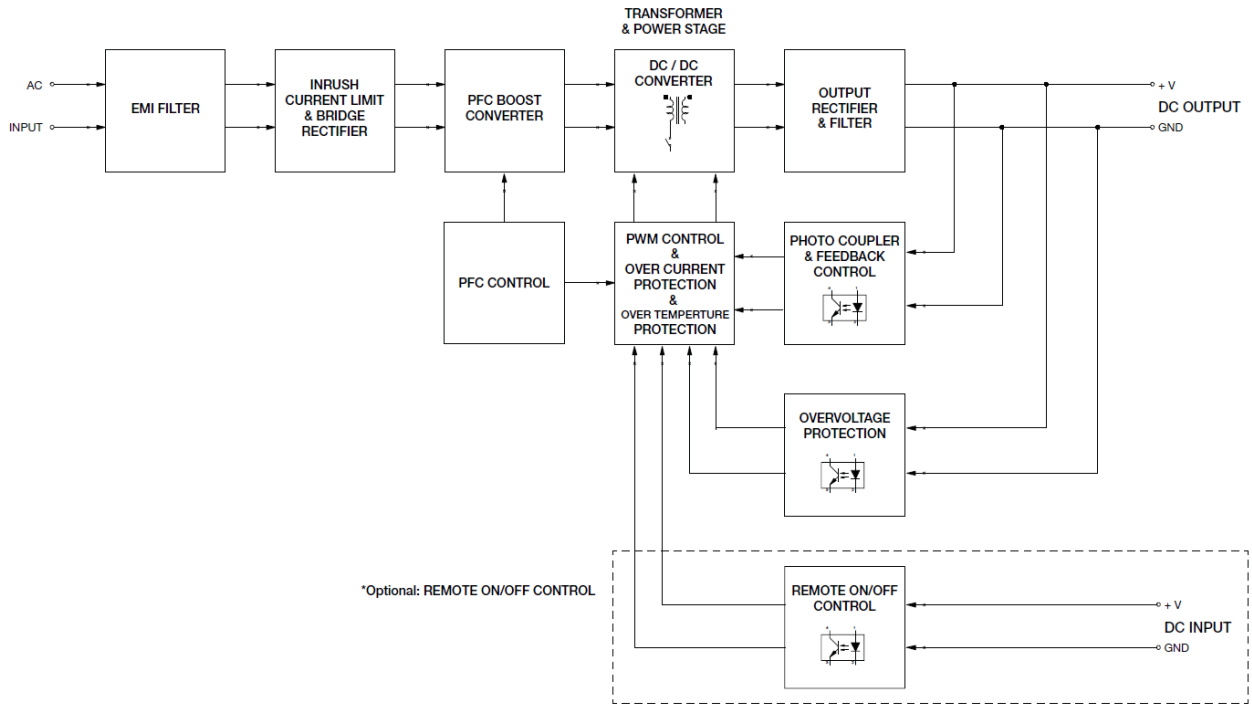

Block Diagram(For Package Type : G 、 H 、 J)

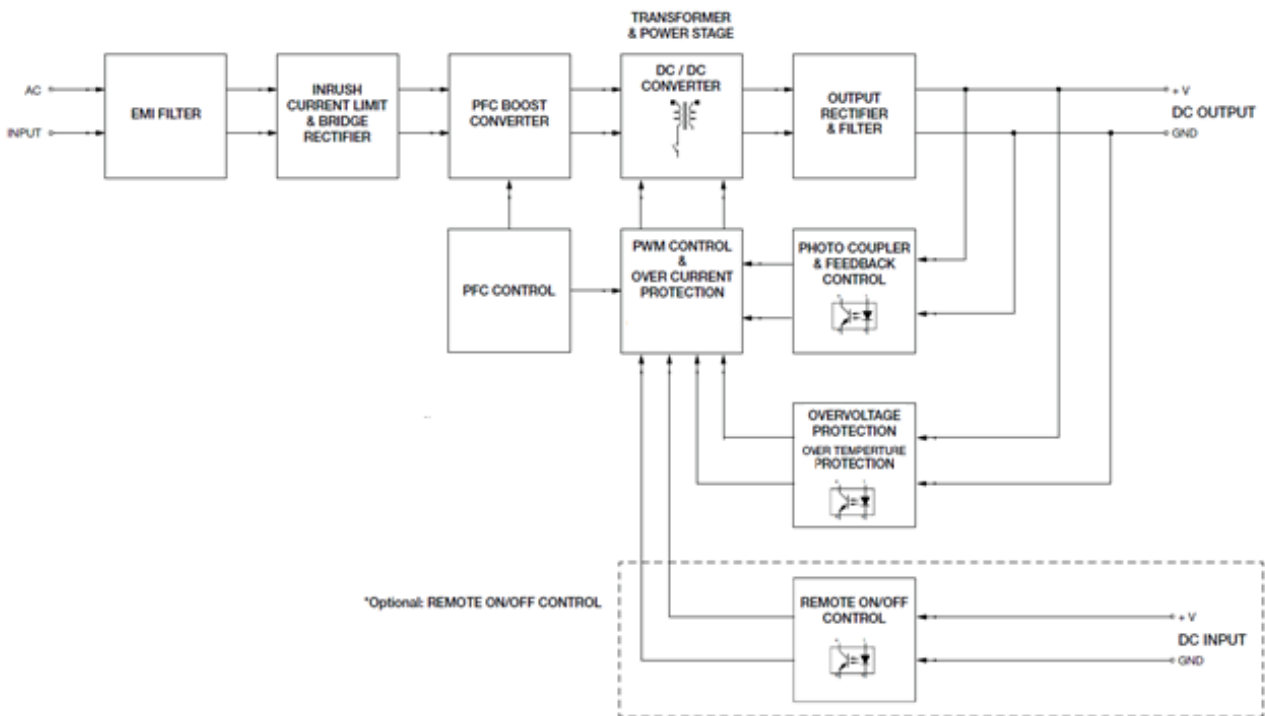

PJB Open Frame Power Supply

24V 150W 1 Phase / PJB-24V150W□□A

Dimensions

Open Frame

L x W x D: 160 x 75 x 37 mm (6.30 x 2.95 x 1.46 inch)

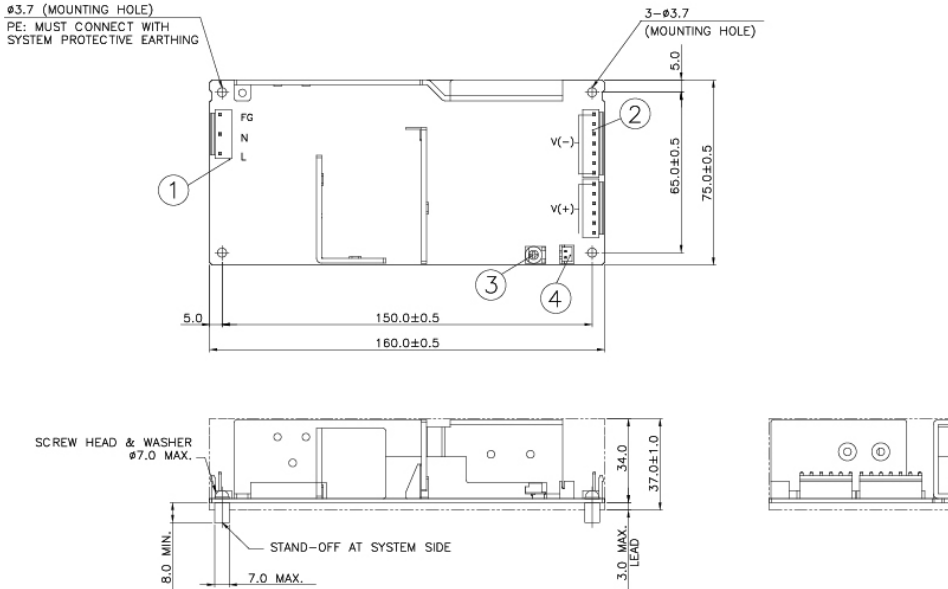

L Frame

L x W x D: 188 x 85 x 47 mm (7.40 x 3.35 x 1.85 inch)

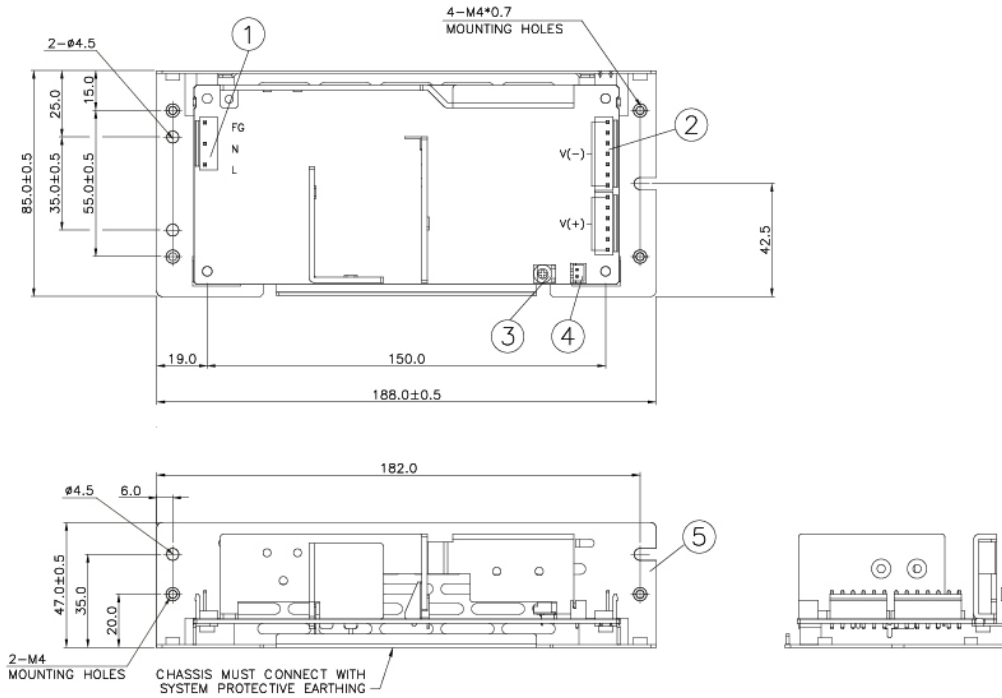

Item	Device Description
1	Input Connector
2	Output Connector
3	VR
4	Remote ON/OFF (JST B2B-XH-A)
5	Chassis

Notes

- Dimensions are in mm
- For information on Mounting Torque, and I/O Connector and Housing, please refer to the Instruction Manual.
- For L Frame type: There are 6 threaded mounting holes and 5 normal mounting holes.
- For Open Frame type: There are 4 normal mounting holes.

PJB Open Frame Power Supply

24V 150W 1 Phase / PJB-24V150W□□A

Enclosed

L x W x D: 188 x 85 x 47 mm (7.40 x 3.35 x 1.85 inch)

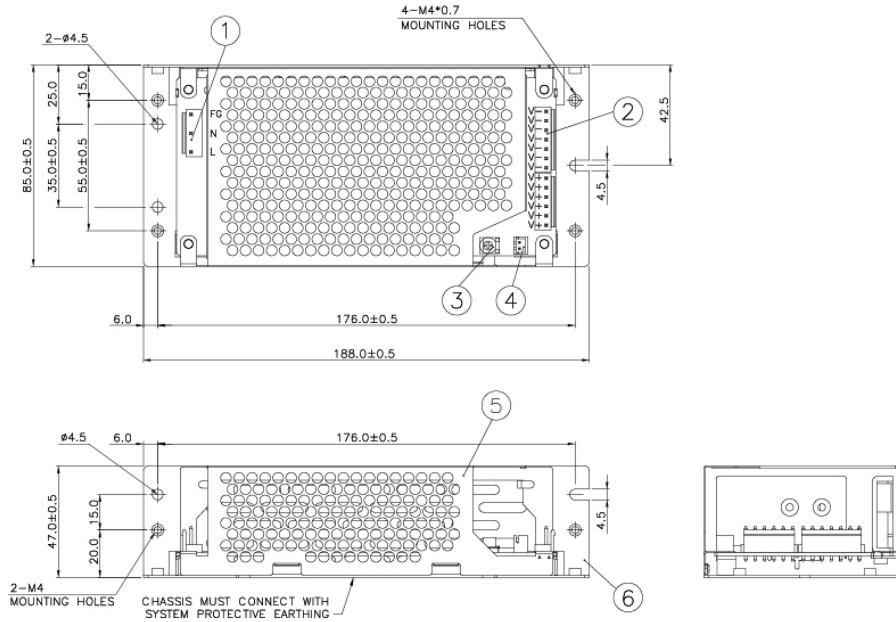

Item	Device Description
1	Input Connector
2	Output Connector
3	VR
4	Remote ON/OFF (JST B2B-XH-A)
5	Cover
6	Chassis

Notes

- Dimensions are in mm
- For information on Mounting Torque, and I/O Connector and Housing, please refer to the Instruction Manual.
- For Enclosed type: There are 6 threaded mounting holes and 5 normal mounting holes.

PJB Open Frame Power Supply

24V 150W 1 Phase / PJB-24V150W□□A

Assembly & Installation

Assembly Reference

■ Open Frame

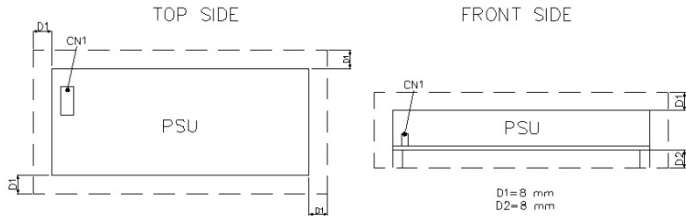

■ L Frame / Enclosed

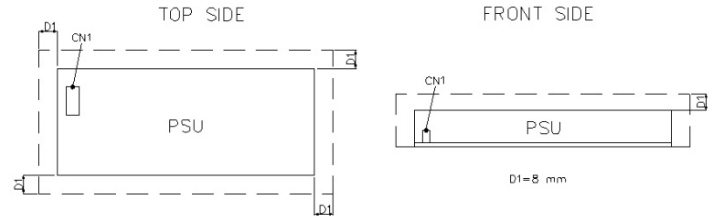

For safety reasons, please ensure the mounted device is kept at $\geq 8\text{mm}$ (0.315 inch) safety distance at all sides from other components and equipments. **Please insert an insulation sheet between the system and product, if the safety distance is less than 8mm (0.315 inch).**

- Use flexible cable (stranded or solid) of AWG No. 22-18. Please refer to Table 1 for the recommended Housing and Terminal.
- For the Remote ON/OFF function, use flexible cable (stranded or solid) of AWG No. 28-22.

		Connector (Board Mounting)	Housing	Terminal
Input (JST)		B3P5-VH(LF)(SN)	VHR-5N	SVH-21T-P1.1
Output (JST)	V-	B7P-VH (LF)(SN)	VHR-7N	
	V+	B6P-VH(LF)(SN)	VHR-6N	
Remote ON/OFF Function (Option)		B2B-XH-A(LF)(SN)	XHP-2	SXH-001T-P0.6

Mounting Orientation

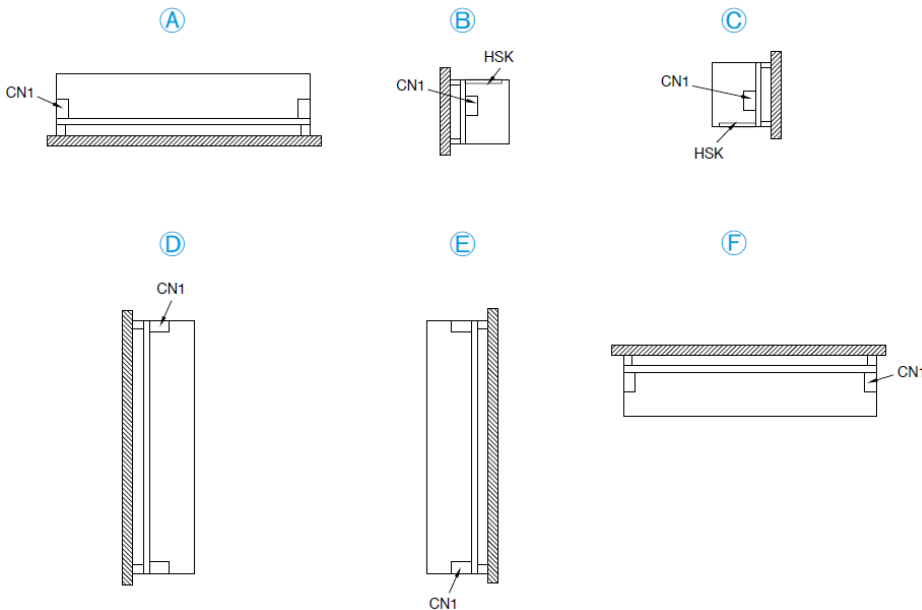

- Any excessive twisting or bending may damage the device's PCB. Please handle the device with care.
- The device is not recommended to be placed on low thermal conductive surfaces. For example, plastics.
- Prevent any foreign metal, particles or conductors from entering the device through the openings during installation. It may cause: -Electric shock; Safety hazard; Product failure.
- **The power supply must be mounted by metal screws onto a grounded metal surface. It is highly recommended that the Earth terminal on the connector be connected to the grounded metal surface.**

PJB Open Frame Power Supply

24V 150W 1 Phase / PJB-24V150W□□A

Engineering Data

Convection

Output Load De-rating VS Surrounding Air Temperature

■ Open Frame / L Frame

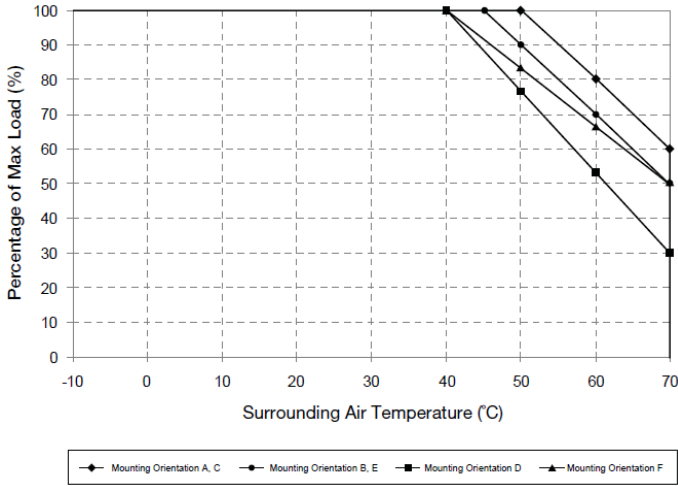

Fig. 1.1 De-rating for Mounting Orientation A, C
 > 50°C de-rate power by 2% / °C
 De-rating for Mounting Orientation B, E
 > 45°C de-rate power by 2% / °C
 De-rating for Mounting Orientation D
 > 40°C de-rate power by 2.33% / °C
 De-rating for Mounting Orientation F
 > 40°C de-rate power by 1.66% / °C

■ Enclosed

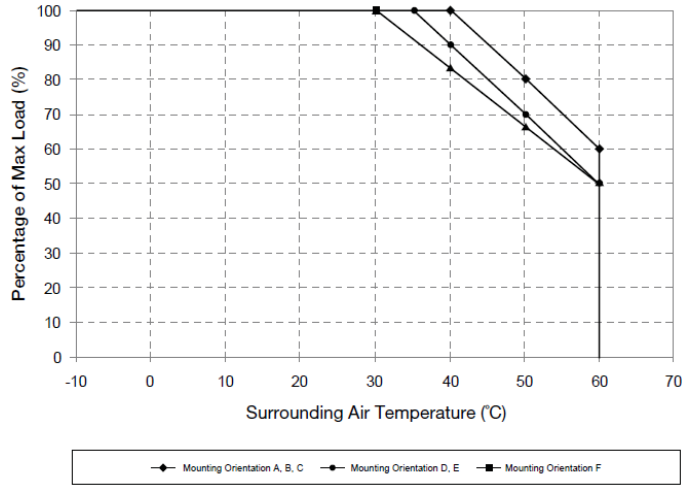
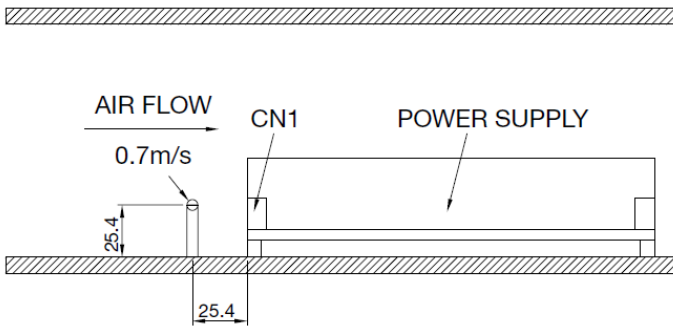

Fig. 1.2 De-rating for Mounting Orientation A, B, C
 > 40°C de-rate power by 2% / °C
 De-rating for Mounting Orientation D, E
 > 30°C de-rate power by 1.66% / °C
 De-rating for Mounting Orientation F
 > 35°C de-rate power by 2% / °C

Forced Cooling (Air Velocity > 0.7m/s)

Output Load De-rating VS Surrounding Air Temperature

■ Air Flow Direction



PJB Open Frame Power Supply

24V 150W 1 Phase / PJB-24V150W□□A

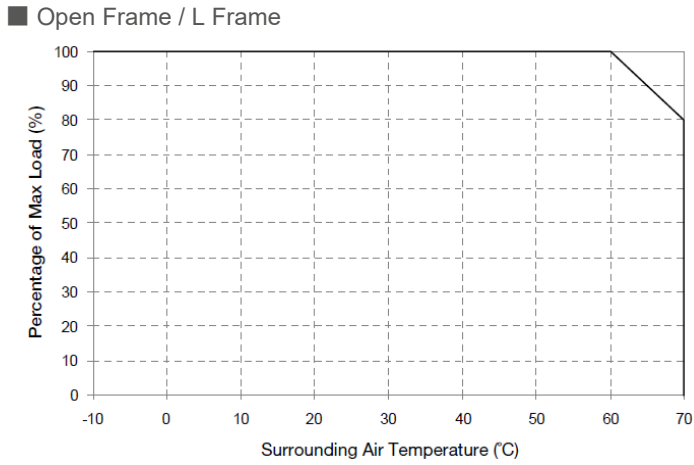

Fig.1.3 De-rating for Mounting Orientation A to F
> 60°C de-rate power by 2% / °C

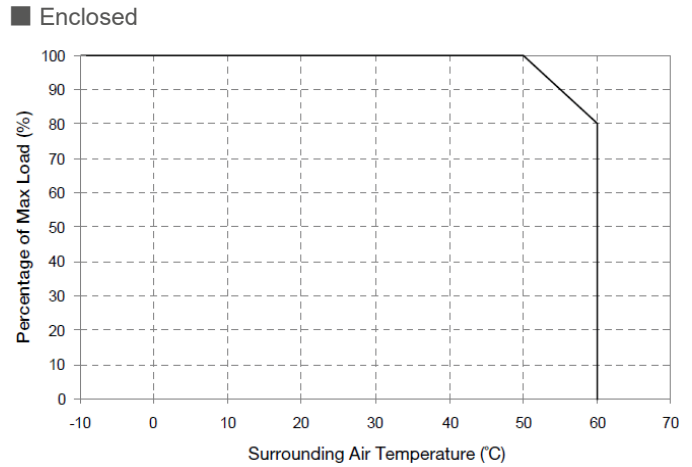
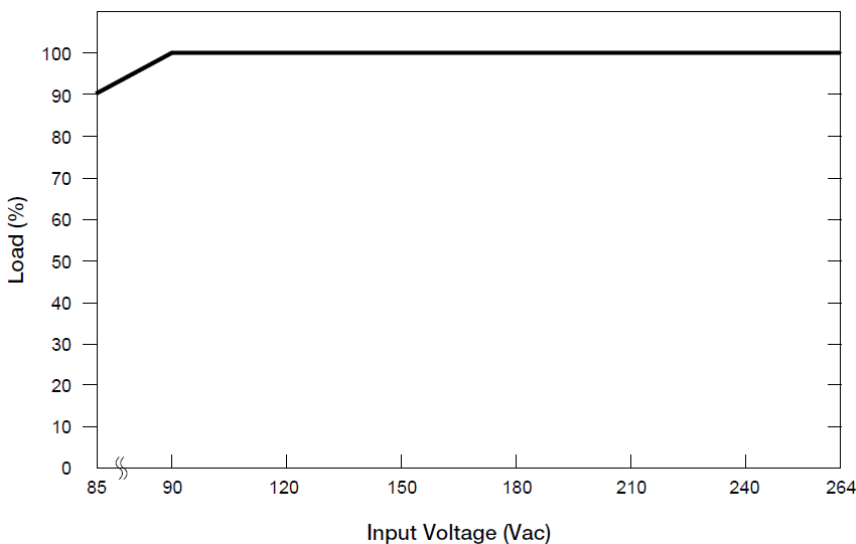

Fig.1.4 De-rating for Mounting Orientation A to F
> 50°C de-rate power by 2% / °C

Notes

1. Power supply components may degrade, or be damaged, when the power supply is continuously used outside the shaded region, refer to the graphs shown above.
2. If the output capacity is not reduced when the surrounding air temperature is more than the upper limit temperature, the device will run into Over Temperature Protection. When activated, the output voltage will go into bouncing mode and will recover when the surrounding air temperature is lowered or the load is reduced as far as necessary to keep the device in working condition.
3. Depending on the surrounding air temperature and output load delivered by the power supply, the device housing can be very hot!
4. If the device has to be mounted in any other orientation, please contact info@deltapsu.com for more details.

Output Load De-rating VS. Input Voltage



■ No output power de-rating for the input voltage range from 90Vac to 264Vac

PJB Open Frame Power Supply

24V 150W 1 Phase / PJB-24V150W□□A

Functional Manual

Remote ON/OFF Function

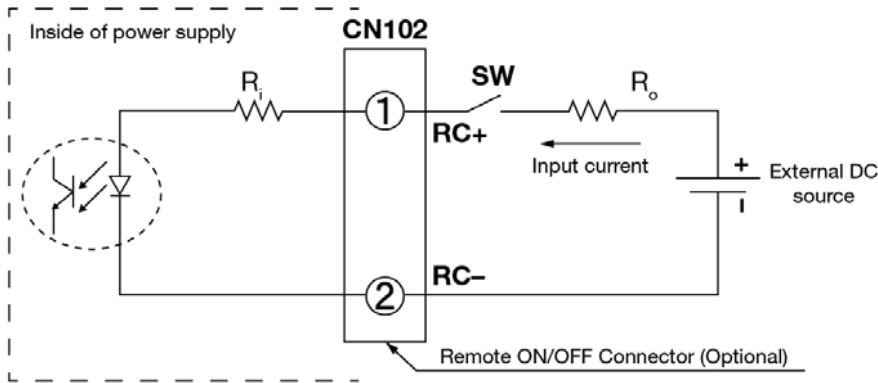

You can remotely control the power supply unit to turn ON/OFF by using an external DC source. Follow the DC power source voltage and current limiting defined in the table below.

Built-in Resistor R_i (ohm)	Voltage Between RC+ and RC- (V)		Input Current (mA)
	Output ON	Output OFF	
1k	5-12.5	0-0.5	20 Max

Notes

1. Remote ON/OFF circuits are isolated from input, output and PE.
2. Please check if the polarity of the wire connector is the same as the external DC source. If not, the power would not turn on and the internal components may be damaged.
3. You do not need an external resistance R_o for current limit while the output voltage of external DC source is within the range of 5-12.5V. If the output voltage exceeds 12.5V, please use the following equation for the value of current limit resistance R_o .

$$R_o = \frac{V_{cc} - (3.5 + 0.006R_i)}{0.006}$$

PJB Open Frame Power Supply

24V 150W 1 Phase / PJB-24V150W□□A

Functions

Start-up Time

The time required for the output voltage to reach 90% of its final steady state set value, after the input voltage is applied.

Rise Time

The time required for the output voltage to change from 10% to 90% of its final steady state set value.

Hold-up Time

Time between the collapse of the AC input voltage, and the output falling to 95% of its steady state set value.

■ Graph illustrating the Start-up Time, Rise Time, and Hold-up Time

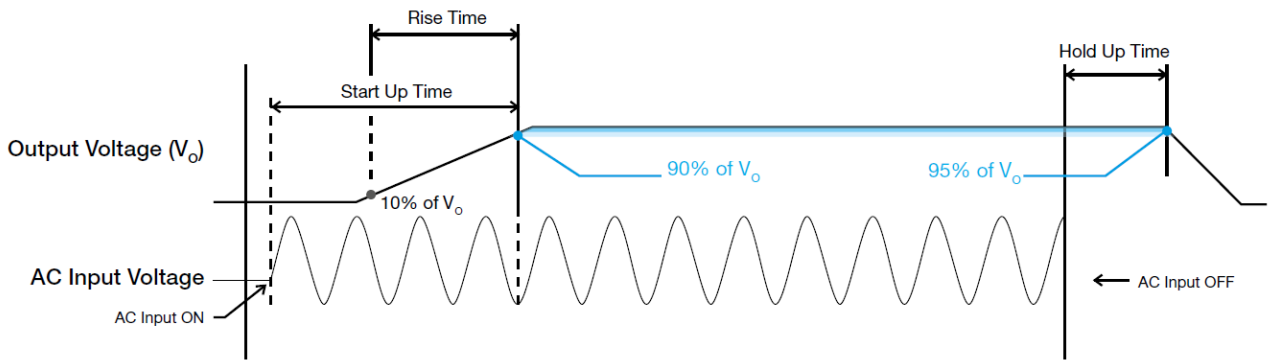

Dynamic Response

The power supply output voltage will remain within $\pm 5\%$ of its steady state value, when subjected to a dynamic load from 0 to 50% and 50 to 100% of its rated current.

■ 0 to 50% Load

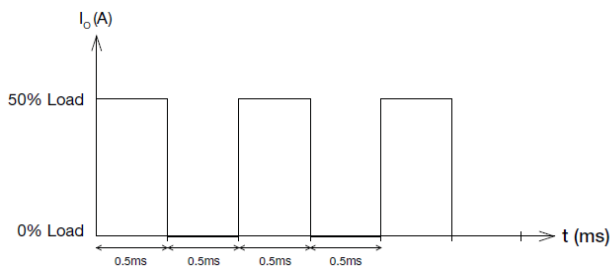

■ 50 to 100% Load

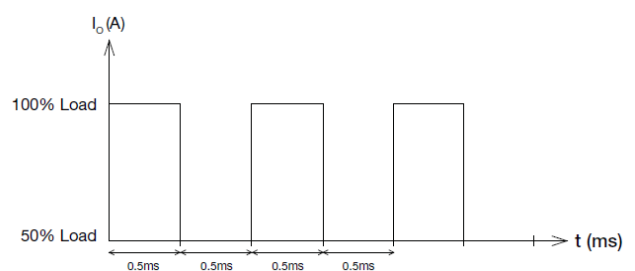

PJB Open Frame Power Supply

24V 150W 1 Phase / PJB-24V150W□□A

Power Boost

Power Boost is the reserve power available constantly that allows reliable startup to support sudden and short spike of loads with high inrush current typically during turn on to remove the need of more expensive higher rated power supply unit. After the output has reached its steady state set value, the power supply can support surge loads with a higher short-term power demand up to 200% of maximum rated load (I_o Max), for a maximum duration of 10 seconds. The Power Boost is also available to repeatedly basis with according to the condition of an average (R.M.S) output power shall not exceed continuous operating condition or refer to duty cycle calculation below.

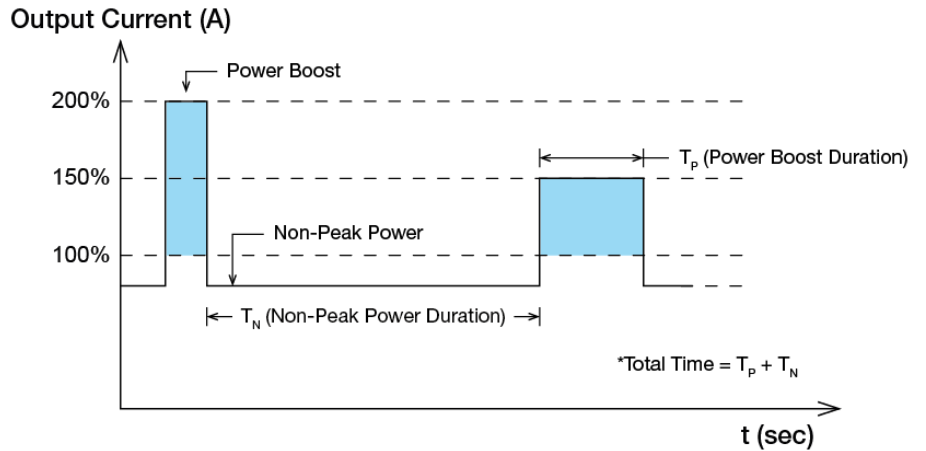

$$Duty\ cycle\ (\%) = \frac{T_P}{Total\ Time} ; (T_P \leq 10\ sec)$$

$$Average\ Output\ Power\ (P_{Avg}) = \frac{(Power\ Boost \times T_P) + (Non-Peak\ Power \times T_N)}{Total\ Time}$$

OR

$$Non-Peak\ Power = \frac{(P_{Avg} \times Total\ Time) - (Power\ Boost \times T_P)}{T_N}$$

■ An example of Power Boost and Average Output Power

Power Boost	Peak Power (W _P)	Power Boost Duration (T _P)	Duty Cycle	Non-Peak Power (W _N)	Non-Peak Power Duration (T _N)	Total Time (T)
200%	302.4W	10 sec	15%	124.52W	56.67 sec	66.67 sec
200%	302.4W	5 sec	15%	124.52W	28.33 sec	33.33 sec
150%	225W	10 sec	40%	102W	15 sec	25 sec
150%	225W	5 sec	40%	102W	7.5 sec	12.5 sec

It is not recommended to prolong the duration of Power Boost to be longer than the specified duty cycle calculation, this may cause damage to the PSU.

PJB Open Frame Power Supply

24V 150W 1 Phase / PJB-24V150W□□A

Inrush Current

Inrush current is the peak, instantaneous, input current measured and, occurs when the input voltage is first applied. For AC input voltages, the maximum peak value of inrush current will occur during the first half cycle of the applied AC voltage. This peak value decreases exponentially during subsequent cycles of AC voltage.

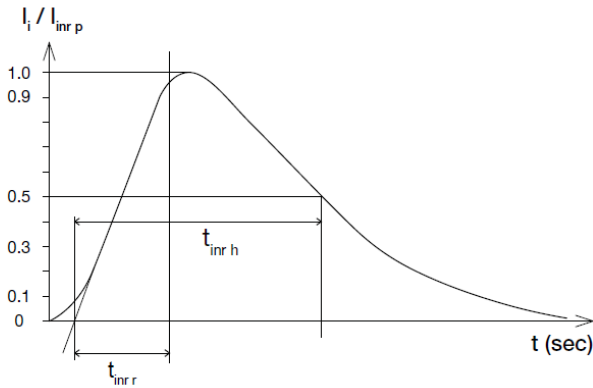

Overvoltage Protection (Latch Mode)

The power supply's overvoltage circuit will be activated when its internal feedback circuit fails. The output voltage shall not exceed its specifications defined on Page 3 under "Protections". Power supply will latch off, and require removal/re-application of input AC voltage in order to restart.

The power supply should be latch.

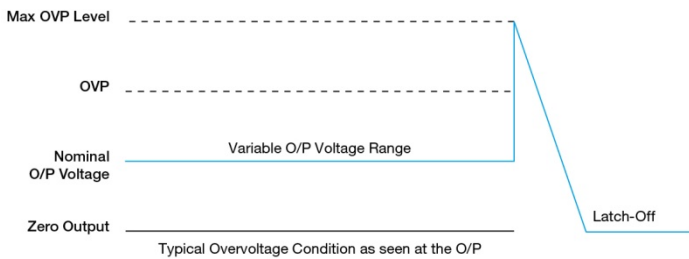

Overload & Overcurrent Protections (Auto-Recovery)

The power supply's Overload (OLP) and Overcurrent (OCP) Protections will be activated when output current exceeds 220% of I_o (Max load). In such occurrence, the V_o will start to droop and once the power supply has reached its maximum power limit, the protection is activated and the power supply will go into "Hiccup mode" (Auto-Recovery). The power supply will recover once the fault condition of the OLP and OCP is removed and I_o is back within the specifications.

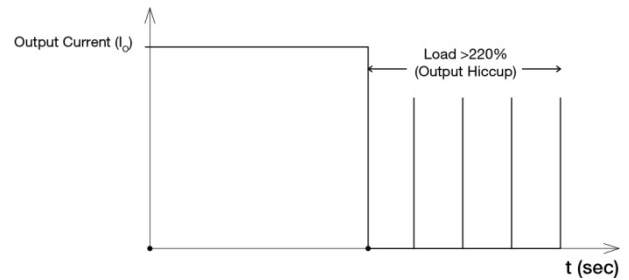

It is not recommended to prolong the duration of I_o when it is $<220\%$ but $>100\%$, since it may cause damage to the PSU.

Over Temperature Protection (Latch Mode)

As described in load de-rating section, the power supply also has Over Temperature Protection (OTP). In the event of a higher operating temperature at 100% load; or, when the operating temperature is beyond what is recommended in the de-rating graph, the OTP circuit will be activated. When activated, power supply will latch off, until the surrounding air temperature drops to its normal operating temperature or the load is reduced as recommended in the de-rating graph. Removal/re-application of input AC voltage will then be required in order to restart.

Short Circuit Protection (Auto-Recovery)

The power supply's output OLP/OCP function also provides protection against short circuits. When a short circuit is applied, the output current will operate in "Hiccup mode", as shown in the illustration in the OLP/OCP section on this page. The power supply will return to normal operation after the short circuit is removed.

PJB Open Frame Power Supply

24V 150W 1 Phase / PJB-24V150W□□A

Others

Conformal Coating

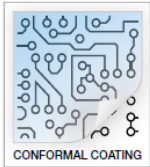

The Protective Coating Technology

Delta Electronics Group has designed the perfect dipping technique which penetrates everywhere including under device, and prevents leakage. The conformal coating dipping can be applied to PCBs or circuit board. The coating preserves the performance of precision electronic primarily by preventing ionizable contaminants such as salt from reaching circuit nodes, where the material slumps around sharp edges. This can be a problem especially in highly conversing atmosphere.

PFC – Norm EN 61000-3-2



Line Current Harmonic content

Typically, the input current waveform is not sinusoidal due to the periodical peak charging of the input capacitor. In industrial environment, complying with EN 61000-3-2 is only necessary under special conditions. Complying to this standard can have some technical drawbacks, such as lower efficiency as well as some commercial aspects such as higher purchasing costs. Frequently, the user does not profit from fulfilling this standard, therefore, it is important to know whether it is mandatory to meet this standard for a specific application.

Attention

Delta provides all information in the datasheets on an “AS IS” basis and does not offer any kind of warranty through the information for using the product. In the event of any discrepancy between the information in the catalog and datasheets, the datasheets shall prevail (please refer to www.DeltaPSU.com for the latest datasheets information). Delta shall have no liability of indemnification for any claim or action arising from any error for the provided information in the datasheets. Customer shall take its responsibility for evaluation of using the product before placing an order with Delta.

Delta reserves the right to make changes to the information described in the datasheets without notice.



Компания «ЭлектроПласт» предлагает заключение долгосрочных отношений при поставках импортных электронных компонентов на взаимовыгодных условиях!

Наши преимущества:

- Оперативные поставки широкого спектра электронных компонентов отечественного и импортного производства напрямую от производителей и с крупнейших мировых складов;
- Поставка более 17-ти миллионов наименований электронных компонентов;
- Поставка сложных, дефицитных, либо снятых с производства позиций;
- Оперативные сроки поставки под заказ (от 5 рабочих дней);
- Экспресс доставка в любую точку России;
- Техническая поддержка проекта, помощь в подборе аналогов, поставка прототипов;
- Система менеджмента качества сертифицирована по Международному стандарту ISO 9001;
- Лицензия ФСБ на осуществление работ с использованием сведений, составляющих государственную тайну;
- Поставка специализированных компонентов (Xilinx, Altera, Analog Devices, Intersil, Interpoint, Microsemi, Aeroflex, Peregrine, Syfer, Eurofarad, Texas Instrument, Miteq, Cobham, E2V, MA-COM, Hittite, Mini-Circuits, General Dynamics и др.);

Помимо этого, одним из направлений компании «ЭлектроПласт» является направление «Источники питания». Мы предлагаем Вам помощь Конструкторского отдела:

- Подбор оптимального решения, техническое обоснование при выборе компонента;
- Подбор аналогов;
- Консультации по применению компонента;
- Поставка образцов и прототипов;
- Техническая поддержка проекта;
- Защита от снятия компонента с производства.



Как с нами связаться

Телефон: 8 (812) 309 58 32 (многоканальный)

Факс: 8 (812) 320-02-42

Электронная почта: org@eplast1.ru

Адрес: 198099, г. Санкт-Петербург, ул. Калинина, дом 2, корпус 4, литера А.