

## Features

- 3939 UVC LED
- Optional Optical Quartz Lens
- ROHS and REACH Compliant
- MSL 4 qualified according to J-STD 020
- ESD 2KV

## Applications

- Medical applications
- Industrial facility applications

## Description

The IN-C39(X)TK UVC series is 10mW UVC LED with Good Thermal Dissipation and High Efficiency. It is a SMD type LED which can be used in various applications.

		
IN-C39ATKU1 30D	IN-C39BTKU1 60D	IN-C39CTKU1 120D
3.9*3.9*3.2mm	3.9*3.9*2.6mm	3.9*3.9*1.6mm

## Recommended Solder Pattern (Suggest Stencil t=0.12 mm)

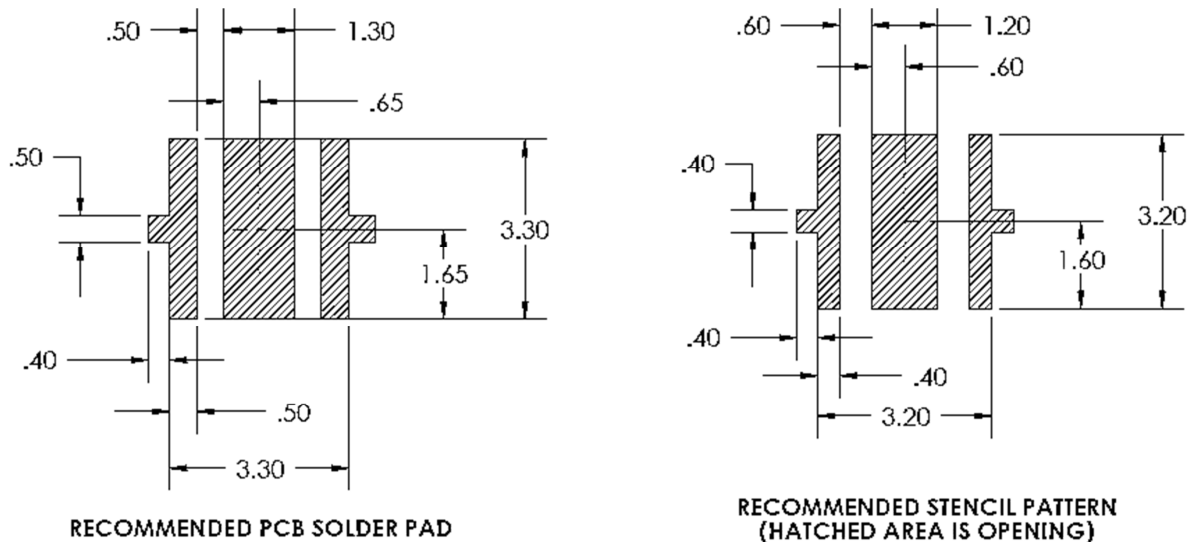

**Figure 1. IN-C39ATKU1 / IN-C39BTKU1 / IN-C39CTKU1 Recommended Solder Pattern**

**Note:**

- \* All dimensions are in millimeters.
- \* Tolerance is  $\pm 0.13$ mm unless other specified.

### Package Dimensions

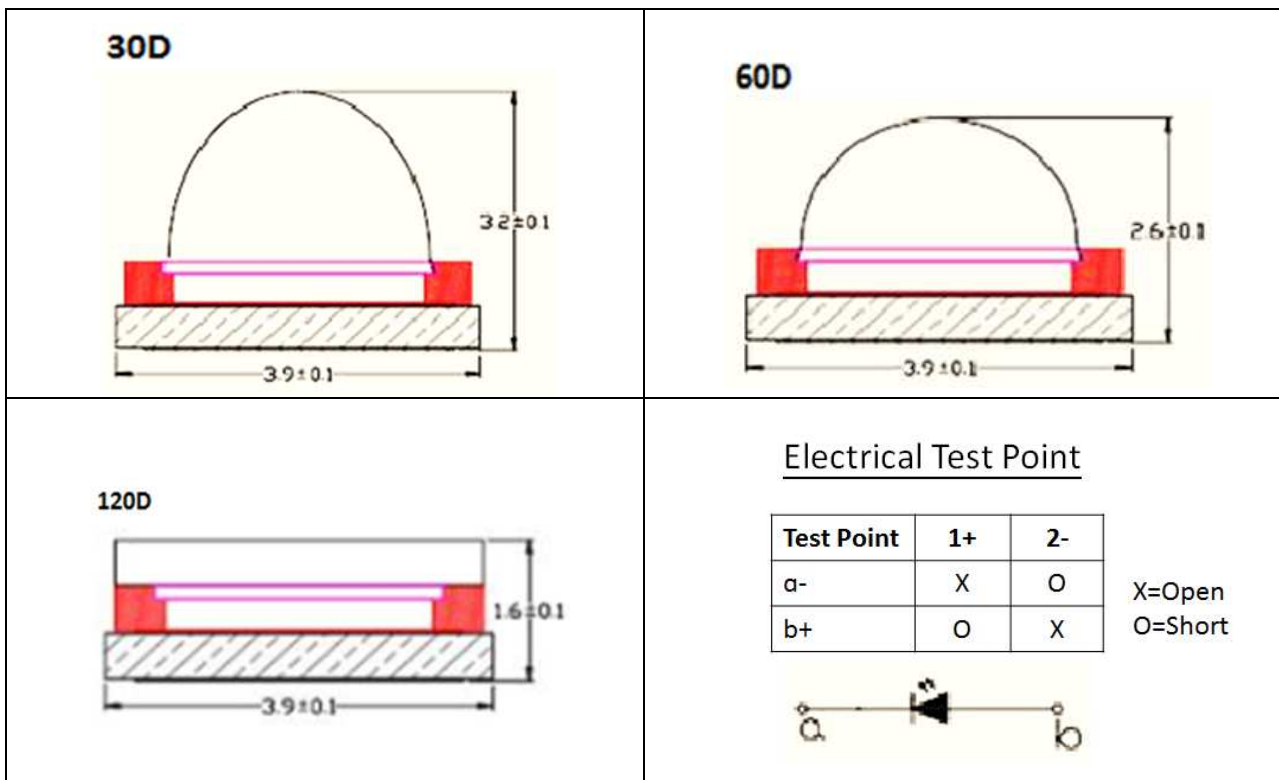
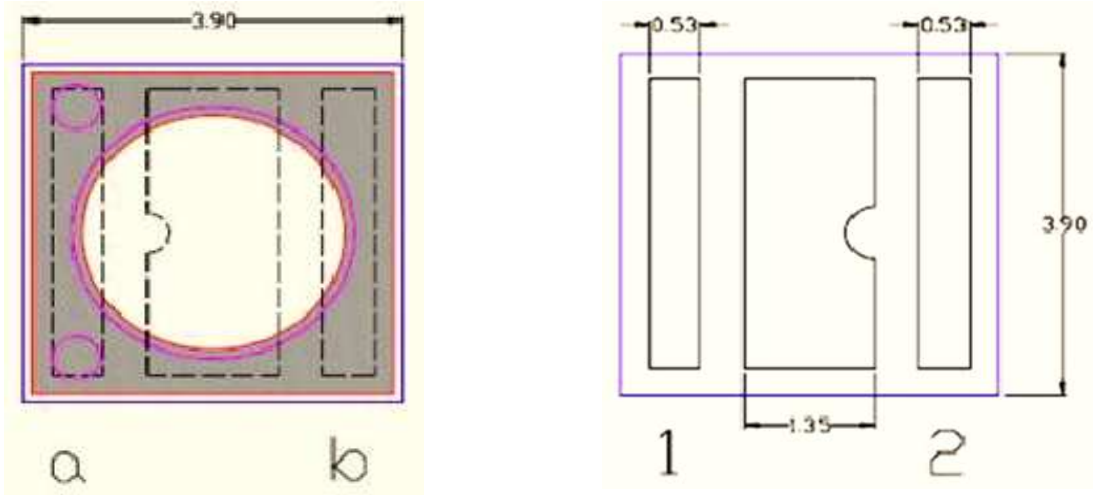

Figure 2. IN-C39ATKU1 / IN-C39BTKU1 / IN-C39CTKU1 Package Dimension

**Note:**

All dimensions are in millimeters.

Tolerance is  $\pm 0.13$ mm unless other specified.

## Absolute Maximum Rating at 25°C

Characteristics	Symbol	Min.	Typical	Max.	Unit
DC Forward Current <sup>1</sup>	IF	---	---	150	mA
Pulse Current (@1/10 duty) <sup>2</sup>	IP	---	---	TBD	mA
Forward Voltage	VF	5.0	---	9.0	V
Junction Temperature <sup>3</sup>	Tj	---	65	---	°C
Storage Temperature Range	Tstg	-40	---	80	°C
Soldering Temperature	Tsol	---	---	245	°C
Thermal Resistance Junction / Solder Point	Rth	---	4.5	---	°C/W
Viewing Angle <sup>4</sup>	2θ1/2	---	30/60/120	---	Deg

**Notes:**

1. When operating at other than ambient temperature, maximum allowable current depends on derating curves.
2. Pulse width = 0.01s & duty factor = 1/10.
3. When operating at maximum allowable current, Tj must be below 85 °C.
4. Viewing angle tolerance is ± 10°.

## Electrical Characteristics T<sub>A</sub> = 25°C (Note 1)

Product	V <sub>F</sub> (V)@150mA			Viewing Angle
	min	typ	max	2 θ 1/2
IN-C39ATKU1 IN-C39BTKU1 IN-C39CTKU1	5.0	---	9.0	30/60/120

**Notes:**

1. Performance guaranteed only under conditions listed in above tables.

## ESD Precaution

ATTENTION: Electrostatic Discharge (ESD) protection



The symbol above denotes that ESD precaution is needed. ESD protection for GaP and AlGaAs based chips is necessary even though they are relatively safe in the presence of low static-electric discharge. Parts built with AlInGaP, GaN, or/and InGaN based chips are STATIC SENSITIVE devices. ESD precaution must be taken during design and assembly. If manual work or processing is needed, please ensure the device is adequately protected from ESD during the process.

Please be advised that normal static precautions should be taken in the handling and assembly of this device to prevent damage or degradation which may be induced by electrostatic discharge (ESD).

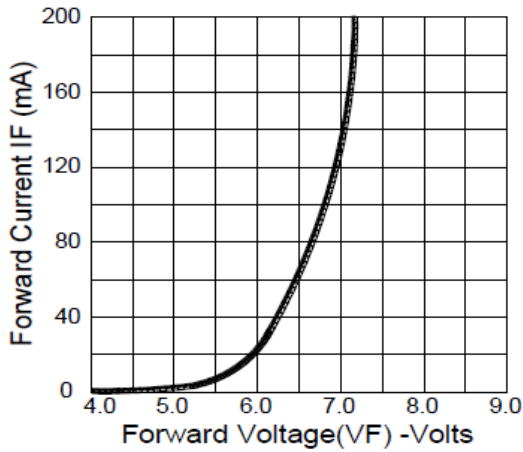
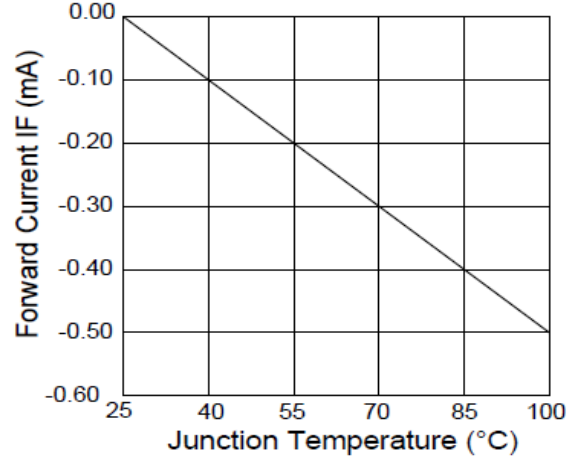
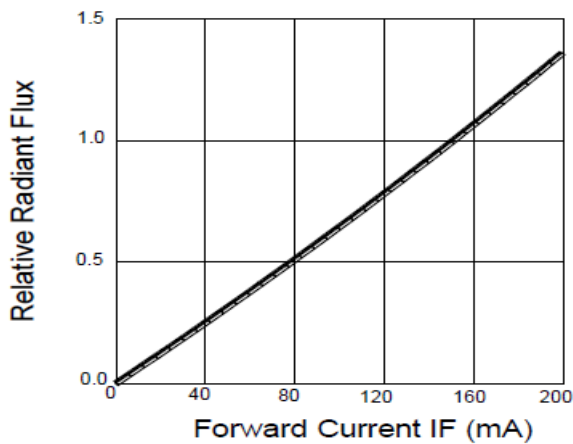
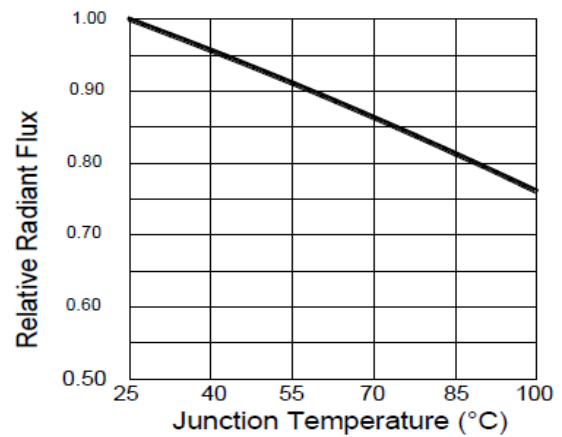
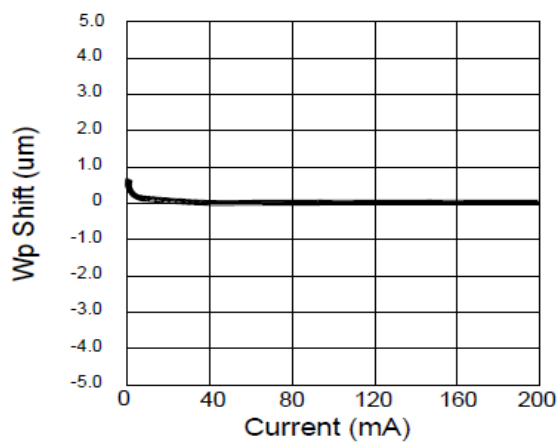
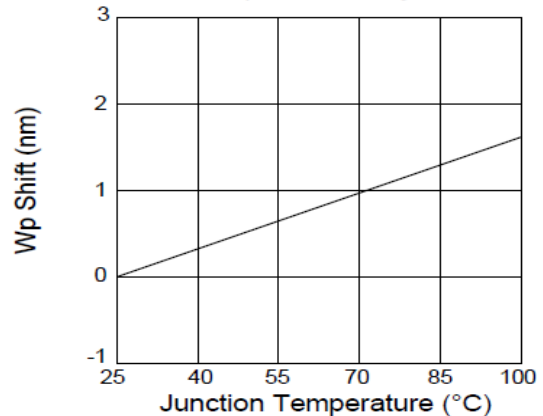
**Electronic-Optical Characteristics**
**Forward Current VS. Forward Voltage**

**Forward Voltage Shift VS. Tj**

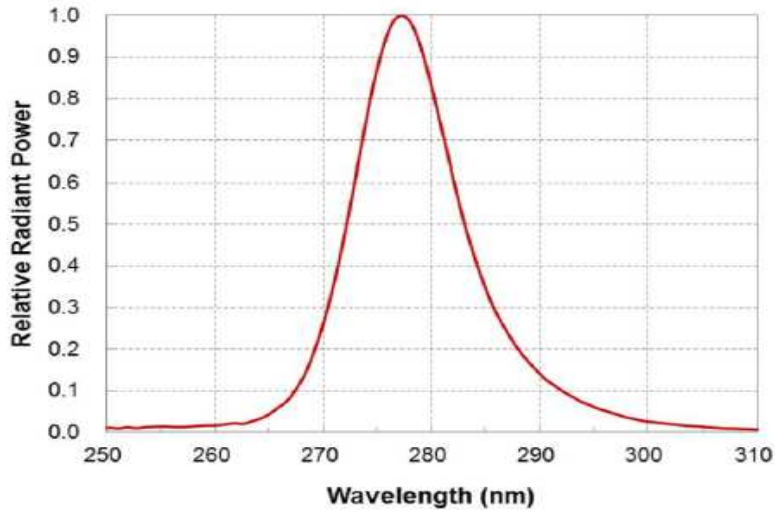
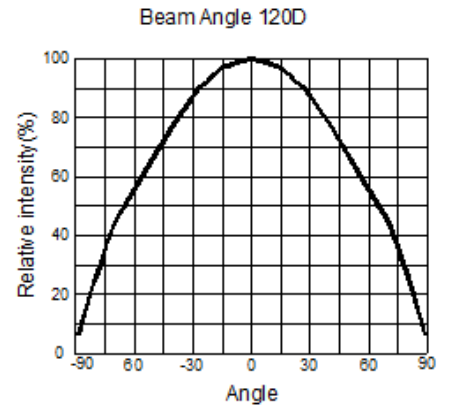
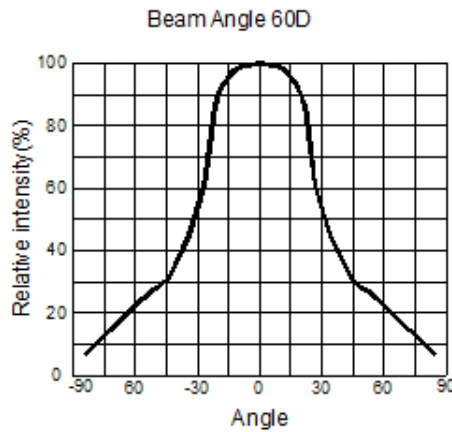
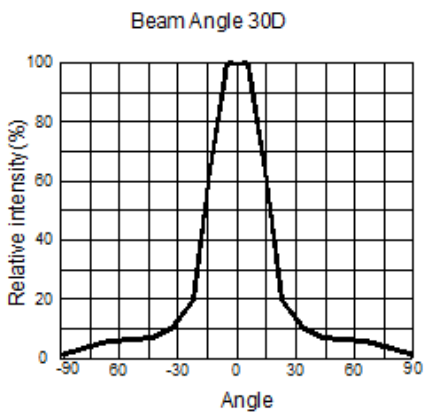
**Relative Radiant Flux VS. Current**

**Relative Radiant Flux VS. Tj**

**Wp Shift VS. Current**

**Wp Shift VS. Tj**

**Notes:**

Viewing angle(2θ1/2) ± 10°

**Relative Spectral Power Distribution**

**Beam Angle (2 $\theta$ 1/2)**

## Ordering Information

Product	Emission Color	Viewing Angle	Orderable Part Number
IN-C39(X)TKU1	U1:265~285nm	30°	IN-C39ATKU1
		60°	IN-C39BTKU1
		120°	IN-C39CTKU1

**Label Specifications**



**Inolux P/N:**

I	N	-	C	3	9	X	T	K		X	-	X	X	X	X
			Material	Package		Variation	Orientation	Current	Lens	Color		Customized Stamp-off			
Inolux SMD			C = Ceramic Type	39A = 3.9 x 3.9 x 3.2, 30 Deg. 39B = 3.9 x 3.9 x 2.6, 60 Deg. 39C = 3.9 x 3.9 x 1.6, 120 Deg.			T = Top Mount	K = 150mA	(Blank) = Clear	U1 = 265-285nm					

**Lot No.:**

Z	2	0	1	7	01	24	001
Internal Tracker	Year (2017, 2018, .....)				Month	Date	Serial

## Peak Wavelength Binning

Peak Wavelength unit: nm@150mA		
Bin Code	Min	Max
U1	265	285

**Notes:**

1. Binning current is 150mA
2. Wavelength tolerance  $\pm 2$ nm

## Voltage Binning

Voltage unit: V@150mA			
Peak Wavelength	Bin Code	Min	Max
U1: 265~285nm	V1	5.0	7.0
	V2	7.0	9.0

**Notes:**

1. Binning current is 150mA

## Radiant flux (Power) binning

Radiant flux (Power) unit: mw@150mA			
Peak Wavelength	Bin Code	Min	Max
U1: 265~285nm	H1	20	30

**Notes:**

1. Binning current is 150mA
2. Power tolerance  $\pm 10\%$

## Thermal Design

Thermal design of the end product is important. The thermal resistance between the junction and the solder point (R<sub>θJ-S</sub>) and the end product should be designed to minimize the thermal resistance from the solder point to ambient in order to optimize the emitter life and optical characteristics. The maximum operation current is determined by the plot of Allowable Forward Current vs. Ambient Temperature.

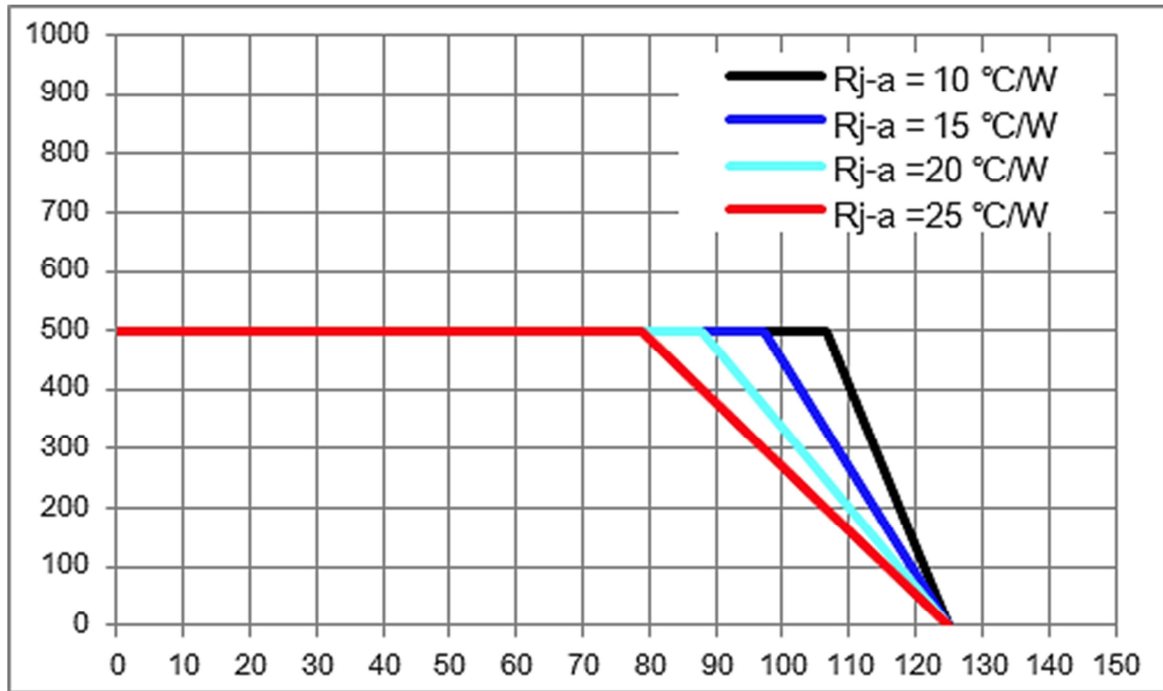

The junction temperature can be correlated to the thermal resistance between the junction and ambient (R<sub>ja</sub>) by the following equation.

$$T_j = T_a + R_{ja} * W$$

T<sub>j</sub> = LED junction temperature

T<sub>a</sub> = Ambient temperature

R<sub>ja</sub> = Thermal resistance between the junction and ambient

W = Input power (I<sub>F</sub>\*V<sub>F</sub>)



## Reflow Soldering

The LEDs can be soldered using the parameter listed below. As a general guideline, the users are suggested to follow the recommended soldering profile provided by the manufacturer of the solder paste. Although the recommended soldering conditions are specified in the list, reflow soldering at the lowest possible temperature is preferred for the LEDs.

Suggested lead-free soldering profile:

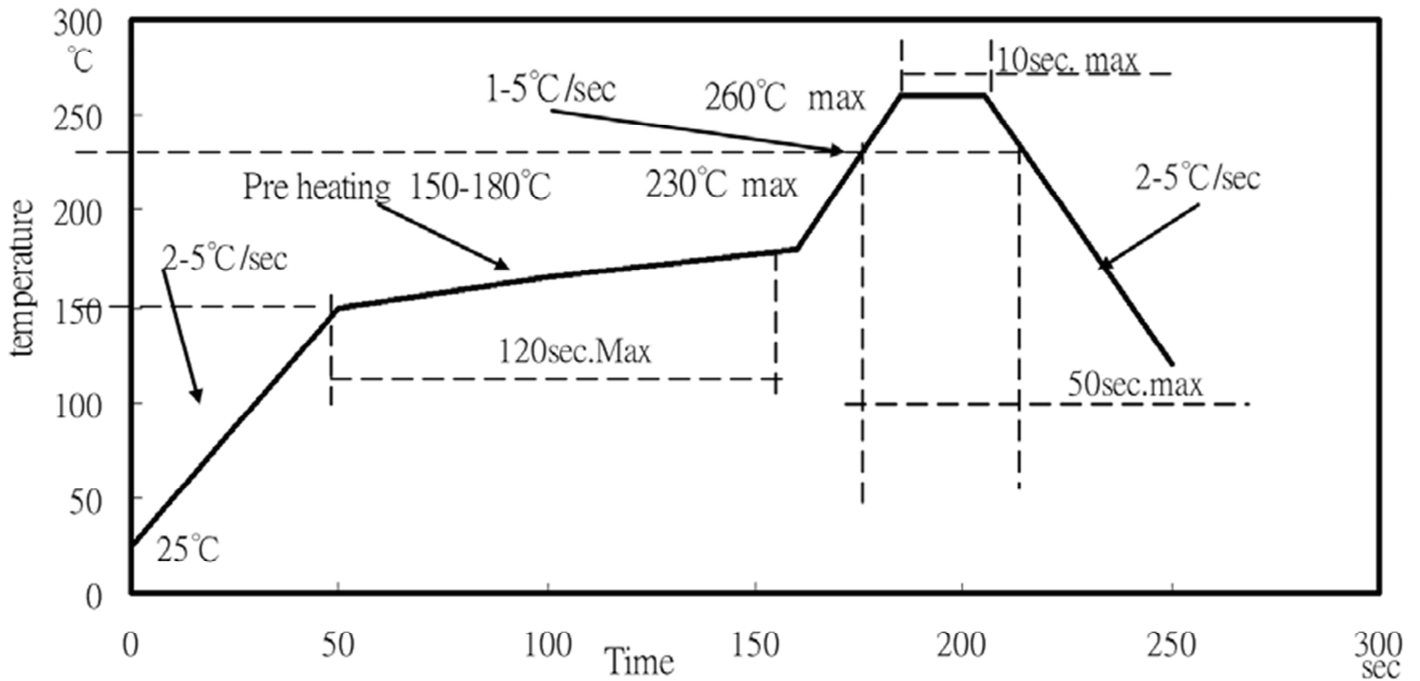

### Notes:

1. The recommended reflow temperature is 240°C(±5°C). The maximum soldering temperature should be limited to 260°C.
2. Do not stress the silicone resin while it is exposed to high temperature.
3. The number of reflow process should not exceed 3 times.

## Packing

The carrier tape conforms to EIA-481D.

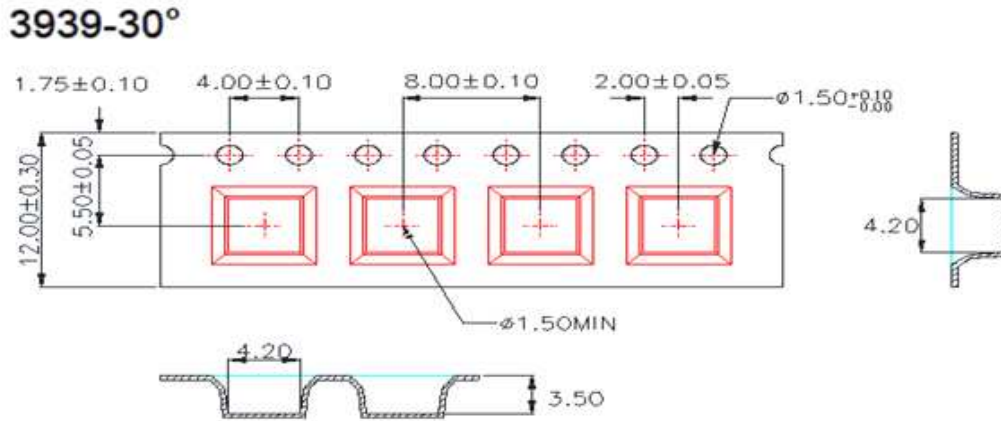

W	A0	B0	K0
12.00±0.30	4.20±0.10	4.20±0.10	3.50±0.10

1. 10 sprocket hole pitch cumulative tolerance  $\pm 0.20$ .
2. Carrier camber is within 1 mm in 250 mm.
3. Material: Black Conductive Polystyrene Alloy.
4. All dimensions meet EIA-481-D requirements.
5. Thickness:  $0.30 \pm 0.05$  mm
6. Packing length per 22" reel: 62.5 Meters (1:3).
7. Component load per 13" reel: 2500 pcs.

## 3939 120° / 60°

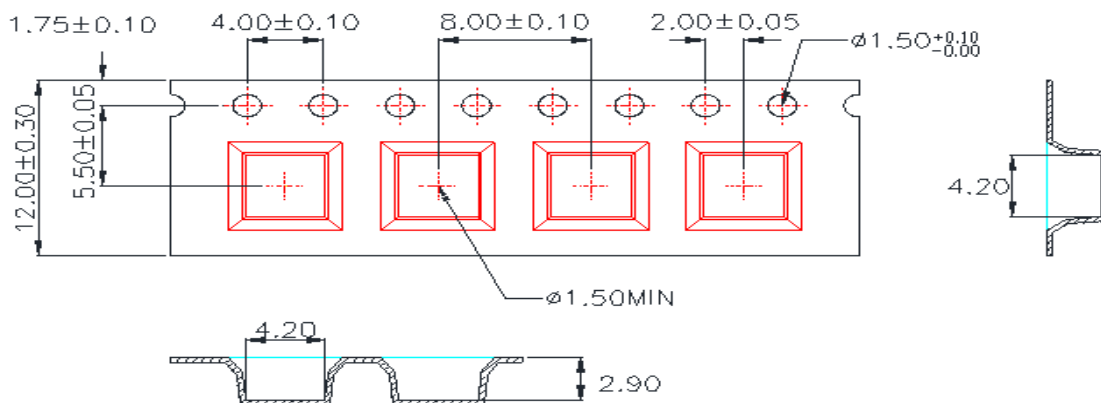

W	A0	B0	K0
12.00±0.30	4.20±0.10	4.20±0.10	3.50±0.10

1. 10 sprocket hole pitch cumulative tolerance  $\pm 0.20$ .
2. Carrier camber is within 1 mm in 250 mm.
3. Material: Black Conductive Polystyrene Alloy.
4. All dimensions meet EIA-481-D requirements.
5. Thickness:  $0.30 \pm 0.05$  mm
6. Packing length per 22" reel: 62.5 Meters (1:3).
7. Component load per 13" reel: 2500 pcs.

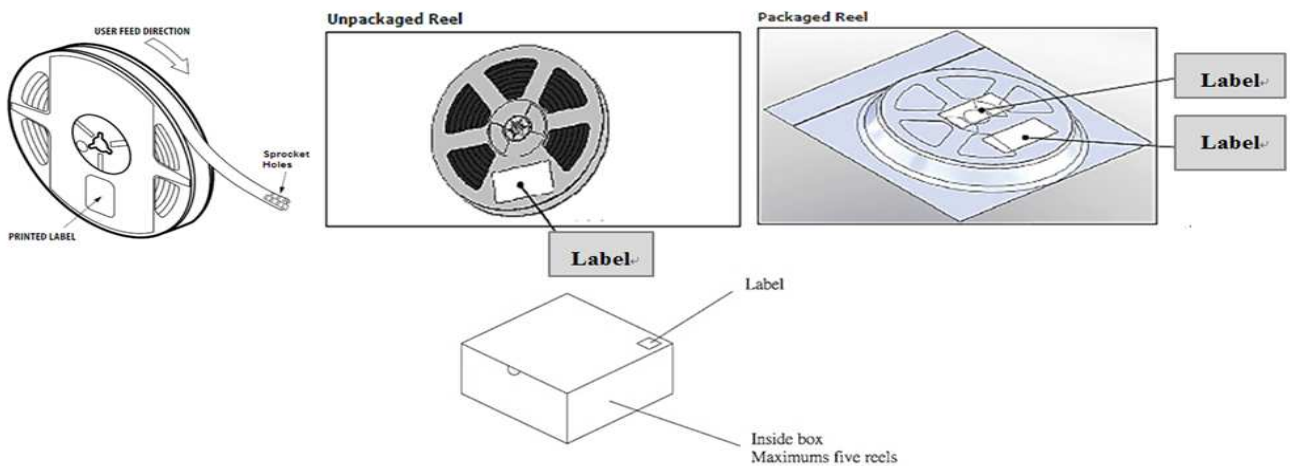
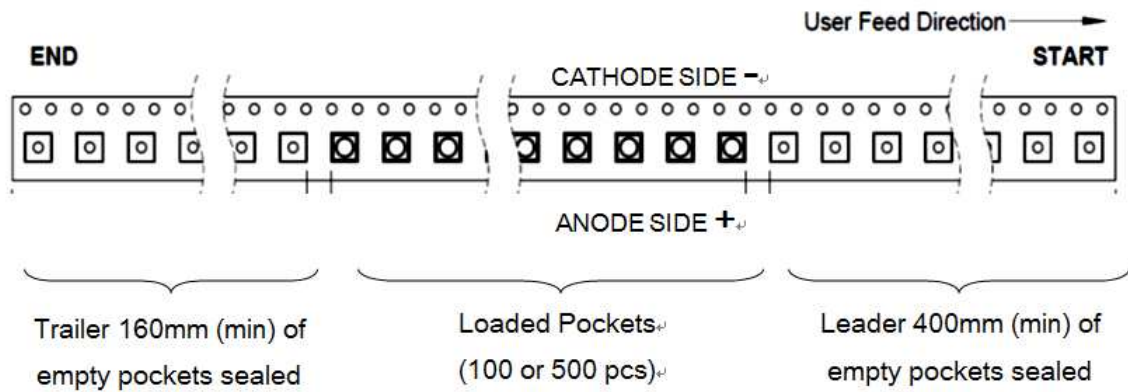
**Notes:**

1. Each Reel (minimum number of pieces is 100 and maximum is 500(30D/60D/120D) packed in a moisture-proof bag along with 2 packs of desiccant and a humidity indicator card.
2. A maximum of 5 moisture-proof bags are packed in an inner box (size: 240mm x 200mm x 105mm  $\pm$  5mm).
3. A maximum of 4 inner boxes are put in an outer box (size: 410mm x 255mm x 230mm  $\pm$ 5mm).
4. Part No., Lot No., quantity should be indicated on the label of the moisture-proof bag and the cardboard box.

## Precautions

### 1. Recommendation for using LEDs

1.1 The lens of LEDs should not be exposed to dust or debris. Excessive dust and debris may cause a drastic decrease in the luminosity.

1.2 Avoid mechanical stress on LED lens.

1.3 Do not touch the LED lens surface. It would affect the optical performance of the LED due to the LED lens' damage.

1.4 Pick & place tools are recommended for the remove of LEDs from the factory tape & reel packaging.

### 2. Pick & place nozzle

The pickup tool was recommended and shown as below:

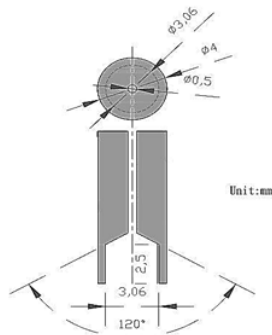

### 3. Lens handling

Please follow the guideline to pick LEDs:

3.1 Use tweezers to pick LEDs.

3.2 Do not touch the lens by using tweezers.

3.3 Do not touch lens with fingers.

3.4 Do not apply more than 4N of force (400g) directly onto the lens.

### 4. Lens cleaning

In the case which a small amount of dirt and dust particles remain on the lens surface, a suitable cleaning solution can be applied.

4.1 Try gently wiping with a dust-free cloth.

4.2 If needed, use a dust-free cloth and isopropyl alcohol to gently remove the dirt from the lens surface.

4.3 Do not use other solvents as they may react with the LED assembly.

4.4 Do not use ultrasonic cleaning which will damage the LEDs.

## Revision History

Changes since last revision	Page	Version No.	Revision Date
Initial Release		1.0	10-26-2018
Format Adjustment		1.1	10-31-2018

## DISCLAIMER

INOLUX reserves the right to make changes without further notice to any products herein to improve reliability, function or design. INOLUX does not assume any liability arising out of the application or use of any product or circuit described herein; neither does it convey any license under its patent rights, nor the rights of others.

## LIFE SUPPORT POLICY

INOLUX's products are not authorized for use as critical components in life support devices or systems without the express written approval of the President of INOLUX or INOLUX CORPORATION. As used herein:

1. Life support devices or systems are devices or systems which, (a) are intended for surgical implant into the body, or (b) support or sustain life, and (c) whose failure to perform when properly used in accordance with instructions for use provided in the labeling, can be reasonably expected to result in a significant injury of the user.
2. A critical component in any component of a life support device or system whose failure to perform can be reasonably expected to cause the failure of the life support device or system, or to affect its safety or effectiveness.



Компания «ЭлектроПласт» предлагает заключение долгосрочных отношений при поставках импортных электронных компонентов на взаимовыгодных условиях!

Наши преимущества:

- Оперативные поставки широкого спектра электронных компонентов отечественного и импортного производства напрямую от производителей и с крупнейших мировых складов;
- Поставка более 17-ти миллионов наименований электронных компонентов;
- Поставка сложных, дефицитных, либо снятых с производства позиций;
- Оперативные сроки поставки под заказ (от 5 рабочих дней);
- Экспресс доставка в любую точку России;
- Техническая поддержка проекта, помощь в подборе аналогов, поставка прототипов;
- Система менеджмента качества сертифицирована по Международному стандарту ISO 9001;
- Лицензия ФСБ на осуществление работ с использованием сведений, составляющих государственную тайну;
- Поставка специализированных компонентов (Xilinx, Altera, Analog Devices, Intersil, Interpoint, Microsemi, Aeroflex, Peregrine, Syfer, Eurofarad, Texas Instrument, Miteq, Cobham, E2V, MA-COM, Hittite, Mini-Circuits, General Dynamics и др.);

Помимо этого, одним из направлений компании «ЭлектроПласт» является направление «Источники питания». Мы предлагаем Вам помощь Конструкторского отдела:

- Подбор оптимального решения, техническое обоснование при выборе компонента;
- Подбор аналогов;
- Консультации по применению компонента;
- Поставка образцов и прототипов;
- Техническая поддержка проекта;
- Защита от снятия компонента с производства.



#### Как с нами связаться

**Телефон:** 8 (812) 309 58 32 (многоканальный)

**Факс:** 8 (812) 320-02-42

**Электронная почта:** [org@eplast1.ru](mailto:org@eplast1.ru)

**Адрес:** 198099, г. Санкт-Петербург, ул. Калинина, дом 2, корпус 4, литера А.