

## PI2161-EVAL1 60V/12A High Side High Voltage Load Disconnect Switch Evaluation Board User Guide

Content	Page
Introduction .....	1
Product Description.....	2
Schematic.....	2
Bill of Materials .....	3
Test Procedure: .....	4
Recommended Material.....	4
PCB layout .....	7
Mechanical drawing. ....	7

Cool-Switch®Series



PI2161-EVAL1 Evaluation Board featuring the Cool-Switch PI2161 Full-Function Load Disconnect Switch.

The PI2161-EVAL1 Evaluation Board is intended to acquaint the user with the benefits and features of the Cool-Switch® PI2161 full function Load Disconnect Switch solution. It is not designed to be installed in end-use equipment.

**Please read this document before setting up the PI2161-EVAL1 Evaluation Board and refer to the PI2161 product datasheet for device specifications, functional description and characteristics.**

During operation, the power devices and surrounding structures can be operated safely at high temperatures.

- Remove power and use caution when connecting and disconnecting test probes and interface lines to avoid inadvertent short circuits and contact with hot surfaces.
- When testing electronic products always use approved safety glasses. Follow good laboratory practice and procedures.

### Introduction

The PI2161-EVAL1 allows the user to test the basic principles and operational characteristics of a Load Switch function, while also experiencing the benefits and value of the PI2161 solution. The PI2161-EVAL1 evaluation board is configured to be installed between the input power source and the load. PI2161 is capable of up to 12A, and is suitable for a bus voltage up to 48V.

The PI2161-EVAL1 evaluation board is designed with an optimized PCB layout and component placement to represent a realistic high density final design for an embedded Load Switch solution for 48V BUS applications requiring up to 12A. This evaluation board is intended as an easy and simple way to test the electrical and thermal

performance of the PI2161 Full-Function Load Switch solution.

Both dynamic and steady state testing of the PI2161 can be completed on the PI2161-EVAL1 evaluation board, in addition to using the key features of the product. Dynamic testing can be completed under a variety of system level fault conditions to check for response time to faults.

This document provides basic instructions for initial start-up and configuration of the evaluation board. Further information on the functionality of the PI2161 can be found in the PI2161 product datasheet.

### Cool-Switch® PI2161 Product Description

The Cool-Switch® PI2161 is a complete full-function Load Disconnect Switch solution for medium voltage applications with a high-speed electronic circuit breaker and a very low on-state resistance MOSFET. It is designed to protect an input power bus from output load fault conditions. The PI2161 Cool-Switch solution is offered in an extremely small, thermally enhanced 7mm x 8mm LGA package. The PI2161 enables an extremely low power loss solution with fast dynamic response to an over current fault or  $\overline{EN}$  high conditions. The PI2161 senses a small portion of the total MOSFET current and has a low voltage threshold allowing the use of low power sense resistors.

Figure 1, shows a photo of the PI2161-EVAL1 evaluation board with one load disconnect switch PI2161 SiP. The board is built with options and features that enable the user to fully explore the capabilities of the PI2161 Load Disconnect Switch.



Figure 1: PI2161-EVAL1 Evaluation Board (1.8" x 1.8")

#### Terminals Absolute Maximum Rating

Vin+	60V/12Adc
Vout+	60V/12Adc
EN, VO	-0.3V to 17.3V / 10mA

Terminal	Description
Vin+	<b>Power source Input:</b> or bus input designed to accommodate up to 12A continuous current.
Vin-	<b>Input Ground:</b> Connect to the power source low side.
EN	<b>Enable input:</b> Inverse of $\overline{EN}$ , set SW1 to Off position when EN input is used
Vout+	<b>Output:</b> Connect to the load high side.
VO	<b>PI2161 Load Status pin:</b> When the internal MOSFET gate is enabled $VO = \frac{Vout}{10}$
Vout-	<b>Output Ground:</b> Connect to the load low side.

Table 1: PI2161-EVAL1 Evaluation Board Terminals Description

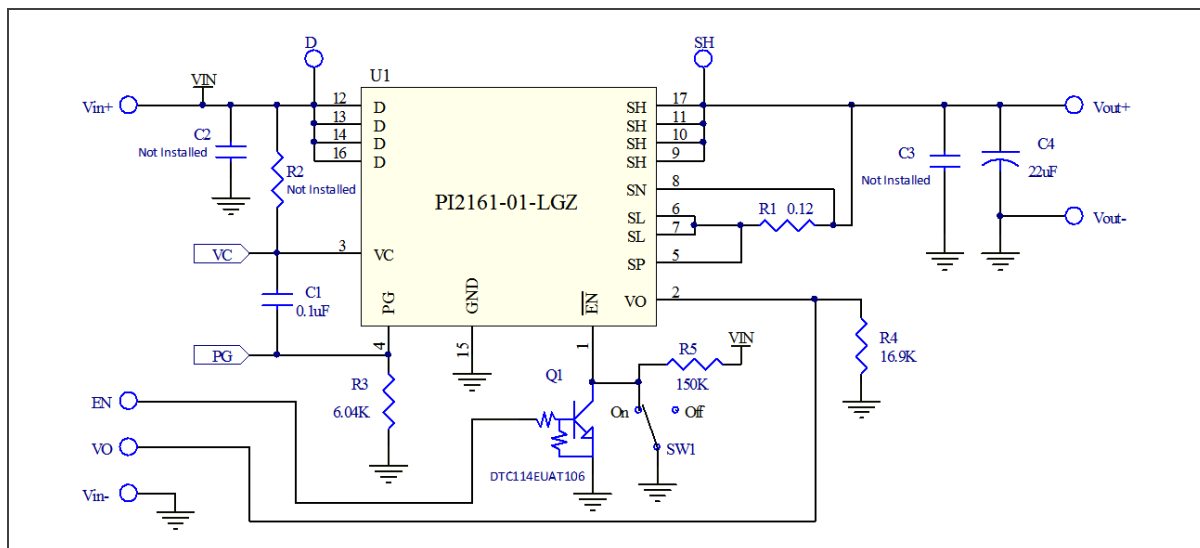

Figure 2: PI2161-EVAL1 Evaluation Board schematic.

Item	QTY	Ref. Designator	Value/Part NO.	Description	Footprint	Manufacturer
1	1	C1	0.1μF	MLCC Capacitor, X7R, 0.1μF,50V	0805	
2	2	C2, C3	1μF	MLCC Capacitor, X7R, 1μF,50V	1206	
3	1	C4	22μF	ELEC Capacitor, 22μF,100V		
4	2	EN, VO	1528	Turret Test point	TURRET - 1528	Keystone Electronics
5	4	Vin+, Vin-, Vout+, Vout-	1502	Turret Test point	TURRET - 1502	Keystone Electronics
6	1	Q1	DTC114EUAT106	Transistor, Digital NPN,50V	SOT-323	Rohm Semiconductor
7	1	R1	120mΩ	Resistor, 0.12Ω,1%,0.25W	0805	
8		R2	Not installed	Resistor	0805	
9	1	R3	6.04kΩ	Resistor,6.04K,1%,0.25W	1206	
10	1	R4	16.9kΩ	Resistor,16.9K,1%,0.1W	0603	
11	1	R5	150kΩ	Resistor,150K,1%,0.1W	0603	
12	1	SW1	Switch	SW SPDT SM	CAS-120	
13	1	U1	PI2161-01-LGIZ	Picor Cool-Switch Controller IC	7mmx8mm 17-pin LGA SiP	PICOR

**Table 2:** PI2161-EVAL1 Evaluation Board Bill of Materials

Ref. Designator	Value/Part NO.	Functional Description
C1	0.1μF	VC Bypass Capacitor
C2, C3	Not installed	Snubber to reduce high voltage noise after disconnect due to high current short. Recommended value 1μF.
C4	22μF	Output Electrolytic Capacitor
Q1	DTC114EUAT106	PI2161 enable inverting polarity
R1	120mΩ	Current sense resistor
R2	Not installed	Optional high side bias resistor.
R3	6.04kΩ	Low side bias resistor ( $R_{PG}$ )
R4	16.9kΩ	VO voltage divider. When the internal MOSFET gate is enabled $VO = \frac{V_{out}}{10}$
R5	150kΩ	$\overline{EN}$ pin pull-up resistor.
SW1	Switch	Output Enable/Disable switch
U1	PI2161-01-LGIZ	Full-Function Load Disconnect Switch Solution.

**Table 3:** Component functional description

## Test Procedure:

### Initial Test Set Up

PI2161-EVAL1 is configured for 48V  $\pm$ 10% input bus. The current limit is set by the sense resistor R1. The sense resistor is selected (120m $\Omega$ ) for minimum worst case trip current of 11.5A at 125°C.

### Baseline Test Procedure – PI2161 (Refer to Figure 4)

#### 1. Recommended Material

##### 1.1. Material Needed-Picor supplied

- 1.1.1. PI2161-EVAL1
- 1.1.2. PI2161 Product Datasheet

##### 1.2. Recommended Users Supplied Equipment

- 1.2.1. One DC power supply: 0-60V; 15A.
- 1.2.2. One low power logic voltage power supply
- 1.2.3. Load: electronic Load, Power resistors or actual load.
- 1.2.4. Multimeter.
- 1.2.5. Oscilloscope.
- 1.2.6. Appropriately sized interconnect cables.
- 1.2.7. Safety glasses.

Before initial power-up follow these steps to configure the evaluation board for specific end application requirement:

#### 2. Sense resistor (Rs) selection

2.1. In a typical load switch application the sense resistor (Rs), R1 in the PI2161-EVAL1, is selected based on a minimum trip current to allow maximum normal load current without interruption. The sense resistor value can be determined from Overcurrent trip vs. sense resistor chart in Figure 3:

Please refer to PI2161 Datasheet for more details on how to calculate the sense resistor value verses trip current.

**Note:** Make sure that output capacitor inrush current is less than two times the minimum set trip current. Output capacitor inrush current is function of the output capacitor value and output voltage rise time.

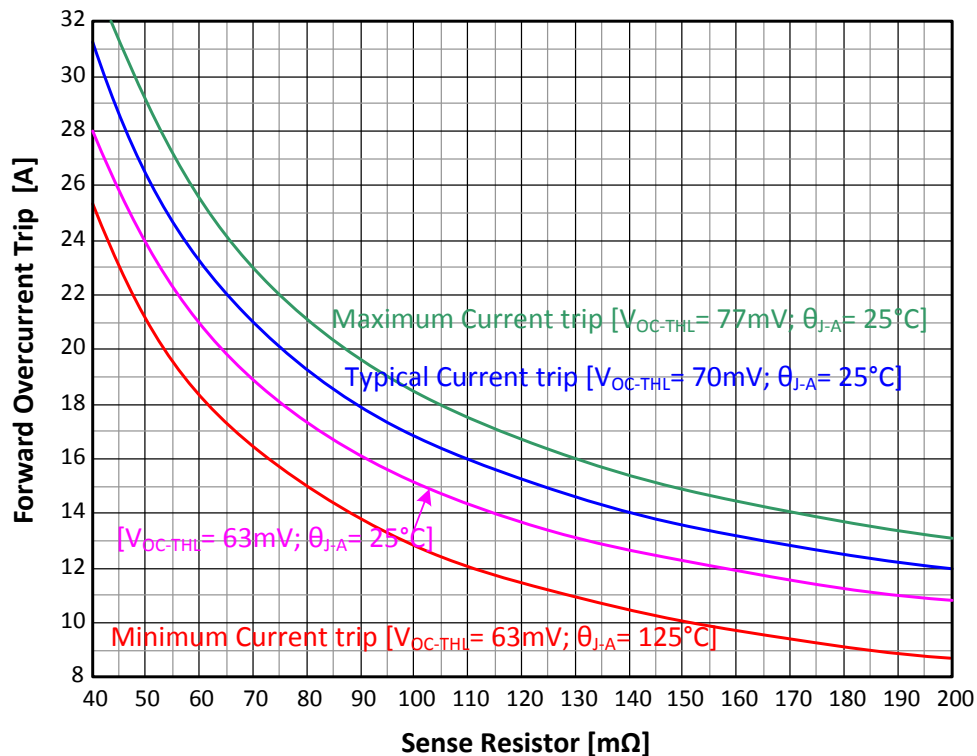
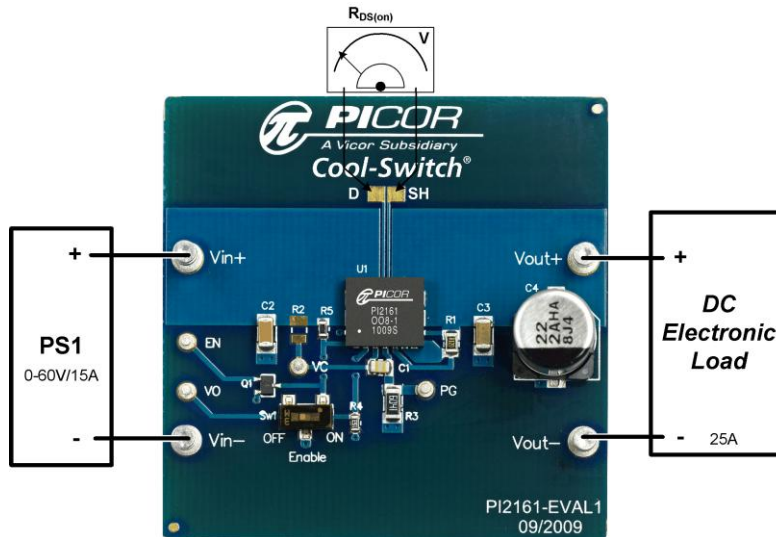

Figure 3: PI2161 Overcurrent trip vs. sense resistor chart



**Figure 4:** Layout configuration for a typical Load Disconnect Switch application test using PI2161.

### 3. Control Circuitry Bias:

As described in the Functional Description section in PI2161 datasheet; in a floating application it is required to place low side bias resistor  $R_{PG}$  (**R3**) between the PG pin and system ground.  $R_{PG}$  creates an offset voltage at the PG pin to regulate VC with respect to PG when the MOSFET is enabled.

The  $R_{PG}$  resistor can be calculated using the following expression:

$$R_{PG} = \frac{V_{VD-UVLO\ Min} - V_{Clamp\ Max} - V_{DBST\ Max}}{I_{VC\ Max} + 100\mu A}$$

Please refer to application section in the PI2161 datasheet for more details.

### 4. Enabling PI2161:

PI2161-EVAL1 is set with two enabling options.

4.1. **Mechanical switch (SW1) option.** Moving SW1 knob to On position to enable (turn on MOSFET if conditions are met) PI2161, or moving SW1 knob to Off position to disable (turn off MOSFET) PI2161.

4.2. **Logic input terminal (EN) option:** to use this option slide WS1 knob to Off position. Apply logic high voltage (>2V) to enable PI2161 and logic low (<1V) to disable PI2161.

### 5. Hook Up of the Evaluation Board

5.1. Connect the positive terminal of PS1 power supply to Vin+. Connect the ground terminal of PS1 to Vin-. Set the power supply to 48V. **Keep PS1 output disabled, off.**

5.2. Connect the electronic load to the output between Vout+ and Vout-. Set the load current to 5A

5.3. Position SW1 knob to On

5.4. Enable (turn on) PS1 power supply output.

5.5. Turn on the electronic load

5.6. Verify that the load voltage (Vout) is few millivolts below 48V. This verifies that the PI2161 MOSFET is in conduction mode.

5.7. Measure VO with respect to Vin-, it should be 10% of Vout, 4.5V.

5.8. Slide SW1 to Off position to disable the output.

5.9. Verify that the load voltage (Vout) is off, about 0V. This verifies that the M1 MOSFET is turned off. VO voltage should be at 0V.

### 6. Over current trip point:

*PI2161 has a very fast response (120ns) to over current fault condition. Measuring a fast disconnect after high current buildup requires attention to the test set-up. Before proceeding, consider the following:*

6.1. To emulate a real application, the BUS supply for this test should have a solid output source such as a DC-DC converter that supply's high current and can be connected very close to the evaluation board. This will reduce stray parasitic inductance. Or use the prospective supply sources of the end application where the PI2161 will be used. Typical bench power supplies have slow response to output load change. In this test when the output load is shorted, a high pulse of

current is sourced from the power supply and its output voltage will drop, but when the MOSFET disconnects the load (shorted) from the source, the bench power supply may produce high output voltage with high current capability that may damage the device under test.

If a bench power supply has to be used, or there is some wiring inter connection between PI2161-EVAL1 input (Vin+ and Vin-) and the power source, add a large electrolytic capacitor between Vin+ and Vin- terminals to reduce power source high voltage transient after load disconnect.

6.2. Place the scope probes very close to PI2161 D pin and SH pin to measure Vout and Vin, and make sure that the scope ground leads are very short.

**6.3. Current trip point:**

To find the exact current trip level, repeat steps 5.1 to 5.9 and then increment the load current slowly. The current can be monitored by a current probe placed at the unit input or by reading the current display at the power supply (PS1) or at the electronic load display. The

actual trip current is the current right before the PI2161 turns the output off, VO output will go to 0V to indicate that the output is disconnect from the source.

After PI2161 turns the output off by pulling the MOSFET gate low, it will hold the MOSFET in an off condition until it is reset.

**6.4. Device Reset:**

To reset PI2161 after a fault (high load current), recycle PI2161  $\overline{EN}$  by sliding SW1 knob to Off position and then slide the knob back to On position.

**6.5. Output short test**

Enable PS1 and then apply a short at the load (Vout). The short can be applied electronically using the electronic load, a MOSFET connected between Vout+ and Vout- or simply by connecting Vout+ to Vout-. Then measure the response time between when the output current reached the set trip point and when PI2161 disconnect the load. An example for PI2161 response time to an output short circuit is shown in Figure 5.

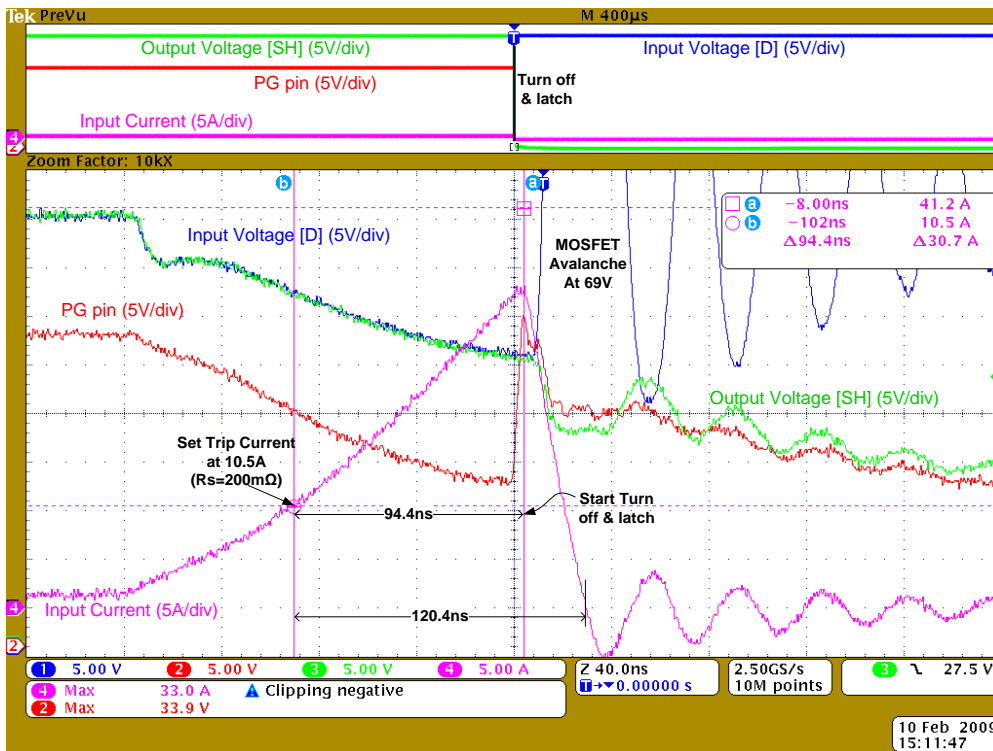

**Test Setup:**

**DUT:** PI2161-EVAL1

**Vin** = 45V

**Output Load** = 1.5A

**Rs (R1)** = 200mΩ

First applied slow ramping load current and determined the trip current: 10.5A

**Test: Apply output short**

PI2161 was enabled and load current is at 1.5A, then shorted Vout+ to Vout- with a MOSFET. The current ramped at 230A/μs. PI2161 turned the output off at load current of 33A, by pulling the MOSFET gate low and latch it low.

PI2161 internal MOSFET starts to turn off 94ns after the current reach the trip point (10.5A). And current reached 0A within 120ns.

Figure 5: Plot of PI2161 response time to a forward over-current condition

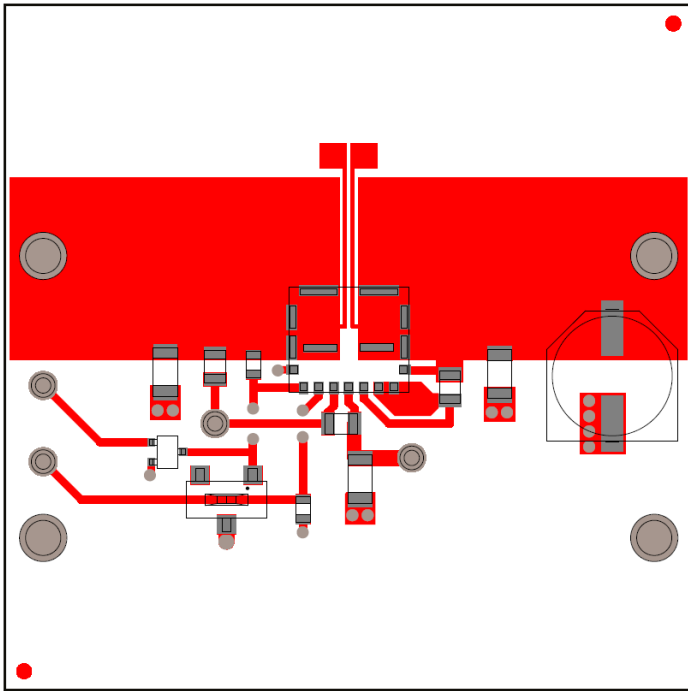

Figure 6: PI2161-EVAL1 layout top layer. Scale 2.0:1

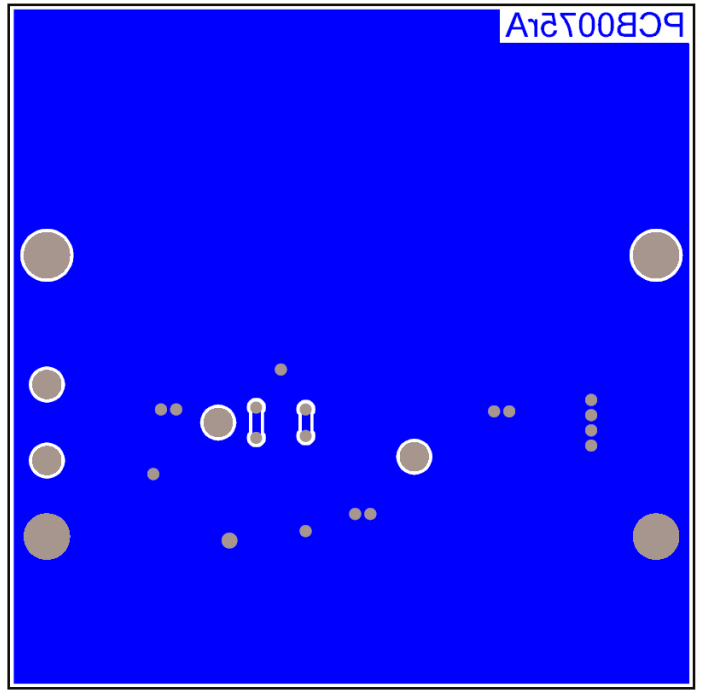

Figure 7: PI2161-EVAL1 layout bottom layer 2. Scale 2.0:1

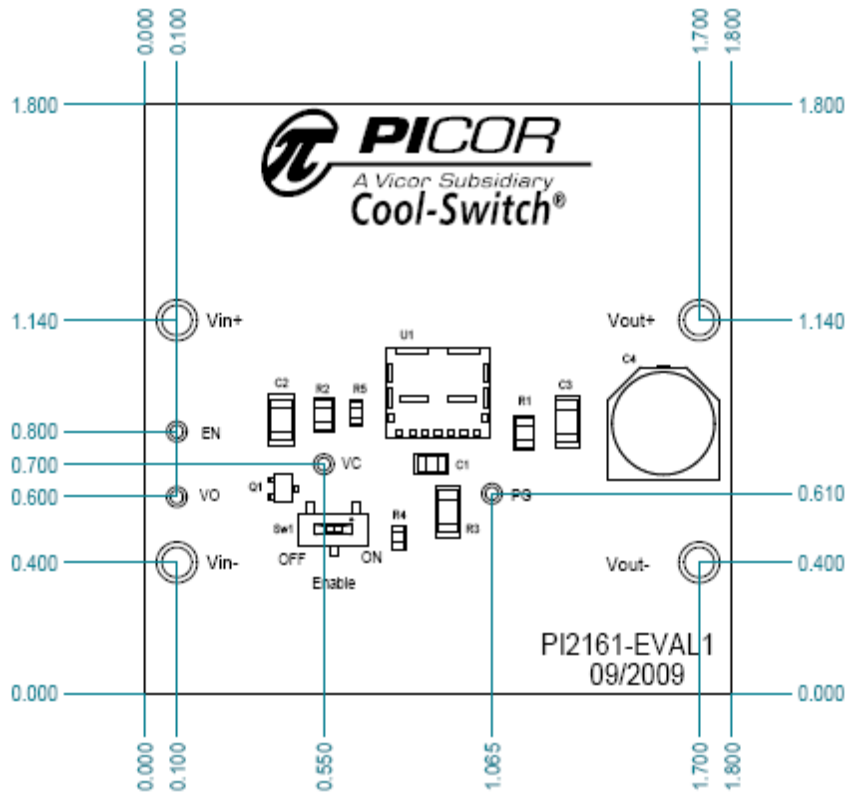

Figure 8: PI2161-EVAL1 evaluation board mechanical drawing.

## Warranty

Vicor products are guaranteed for two years from date of shipment against defects in material or workmanship when in normal use and service. This warranty does not extend to products subjected to misuse, accident, or improper application or maintenance. Vicor shall not be liable for collateral or consequential damage. This warranty is extended to the original purchaser only.

EXCEPT FOR THE FOREGOING EXPRESS WARRANTY, VICOR MAKES NO WARRANTY, EXPRESS OR LIMITED, INCLUDING, BUT NOT LIMITED TO, THE WARRANTY OF MERCHANTABILITY OR FITNESS FOR A PARTICULAR PURPOSE.

Vicor will repair or replace defective products in accordance with its own best judgment. For service under this warranty, the buyer must contact Vicor to obtain a Return Material Authorization (RMA) number and shipping instructions. Products returned without prior authorization will be returned to the buyer. The buyer will pay all charges incurred in returning the product to the factory. Vicor will pay all reshipment charges if the product was defective within the terms of this warranty.

Information published by Vicor has been carefully checked and is believed to be accurate; however, no responsibility is assumed for inaccuracies. Vicor reserves the right to make changes to any products without further notice to improve reliability, function, or design. Vicor does not assume any liability arising out of the application or use of any product or circuit; neither does it convey any license under its patent rights nor the rights of others. Vicor general policy does not recommend the use of its components in life support applications wherein a failure or malfunction may directly threaten life or injury. Per Vicor Terms and Conditions of Sale, the user of Vicor components in life support applications assumes all risks of such use and indemnifies Vicor against all damages.

**Vicor's comprehensive line of power solutions includes high density AC-DC and DC-DC modules and accessory components, fully configurable AC-DC and DC-DC power supplies, and complete custom power systems.**

Information furnished by Vicor is believed to be accurate and reliable. However, no responsibility is assumed by Vicor for its use. Vicor components are not designed to be used in applications, such as life support systems, wherein a failure or malfunction could result in injury or death. All sales are subject to Vicor's Terms and Conditions of Sale, which are available upon request.

**Specifications are subject to change without notice.**

Vicor Corporation  
25 Frontage Road  
Andover, MA 01810  
USA

Picor Corporation  
51 Industrial Drive  
North Smithfield, RI 02896  
USA

Customer Service: [custserv@vicorpower.com](mailto:custserv@vicorpower.com)  
Technical Support: [apps@vicorpower.com](mailto:apps@vicorpower.com)  
Tel: 800-735-6200  
Fax: 978-475-6715





Компания «ЭлектроПласт» предлагает заключение долгосрочных отношений при поставках импортных электронных компонентов на взаимовыгодных условиях!

Наши преимущества:

- Оперативные поставки широкого спектра электронных компонентов отечественного и импортного производства напрямую от производителей и с крупнейших мировых складов;
- Поставка более 17-ти миллионов наименований электронных компонентов;
- Поставка сложных, дефицитных, либо снятых с производства позиций;
- Оперативные сроки поставки под заказ (от 5 рабочих дней);
- Экспресс доставка в любую точку России;
- Техническая поддержка проекта, помощь в подборе аналогов, поставка прототипов;
- Система менеджмента качества сертифицирована по Международному стандарту ISO 9001;
- Лицензия ФСБ на осуществление работ с использованием сведений, составляющих государственную тайну;
- Поставка специализированных компонентов (Xilinx, Altera, Analog Devices, Intersil, Interpoint, Microsemi, Aeroflex, Peregrine, Syfer, Eurofarad, Texas Instrument, Miteq, Cobham, E2V, MA-COM, Hittite, Mini-Circuits, General Dynamics и др.);

Помимо этого, одним из направлений компании «ЭлектроПласт» является направление «Источники питания». Мы предлагаем Вам помощь Конструкторского отдела:

- Подбор оптимального решения, техническое обоснование при выборе компонента;
- Подбор аналогов;
- Консультации по применению компонента;
- Поставка образцов и прототипов;
- Техническая поддержка проекта;
- Защита от снятия компонента с производства.



#### Как с нами связаться

**Телефон:** 8 (812) 309 58 32 (многоканальный)

**Факс:** 8 (812) 320-02-42

**Электронная почта:** [org@eplast1.ru](mailto:org@eplast1.ru)

**Адрес:** 198099, г. Санкт-Петербург, ул. Калинина, дом 2, корпус 4, литера А.