

## MKMxxZxxACxx5

### KM Family

Supports the following:

MKM14Z64ACHH5,  
MKM14Z128ACHH5,  
MKM33Z64ACLH5,  
MKM33Z128ACLH5,  
MKM33Z64ACLL5, MKM33Z128ACLL5,  
MKM34Z128ACLL5

#### Features

- Operating Characteristics
  - Voltage range: 1.71 V to 3.6 V (when Analog Front End (AFE) is not used)
  - Voltage range: 2.7 V to 3.6 V (when Analog Front End (AFE) is used)
  - iRTC battery supply voltage range: 1.71 to 3.6 V
  - Flash write voltage range: 1.71 to 3.6 V
  - Temperature range (ambient): -40°C to 85°C
- Performance
  - Up to 50 MHz ARM Cortex-M0+ core delivering 0.95 Dhrystone MIPS per MHz
- Memories and memory interfaces
  - 128/64 KB program flash memory. There is no FlexMemory on these devices
  - 16 KB of single access RAM
- Clocks
  - 1 to 32 MHz crystal oscillator
  - 32 kHz crystal oscillator
  - Multi-purpose clock generator
- System peripherals
  - Multiple low-power modes to provide power optimization based on application requirements
  - Memory protection unit with multi-master protection
  - 4-channel DMA controller, supporting up to 64 request sources
  - External watchdog monitor
  - Robust watchdog monitor
  - Low-leakage wakeup unit
  - Asynchronous wakeup unit
  - Peripheral Crossbar (allows internal signals to be connected to other on-chip modules)
- Security and integrity modules
  - Hardware programmable CRC module to support fast cyclic redundancy checks
  - Hardware random-number generator
  - 128-bit unique identification (ID) number per chip
- Human-machine interface
  - Segment LCD controller supporting up to 36 frontplanes and 8 backplanes or 40 frontplanes and 4 backplanes
  - General-purpose input/output which can act as Rapid GPIO (single cycle access)
- Analog modules
  - 16-bit SAR ADC
  - 24-bit Analog Front End comprising of 24-bit Sigma Delta ADCs (after averaging)
  - Programmable Gain Amplifier (PGA with gains up to 32)
  - Two analog comparators (CMP) containing a 6-bit DAC and programmable reference input
  - 1.2V Voltage reference
- Timers
  - 4 channel Quad Timer with 16-bit counters
  - Periodic interrupt timers
  - 16-bit low-power timer
  - Independent Real Time Clock with calendaring and compensation



This document contains information on a new product. Specifications and information herein are subject to change without notice.

- Communication interfaces
  - One SPI module with FIFO support (supports 5V AMR operation)
  - One SPI module without FIFO (no AMR operation)
  - Two I2C modules with SMBus support
  - Two UART modules with ISO7816 support and Two UART without ISO 7816 support
  - Any one SCI can be used for IrDA operation. 5V AMR support on one SCI.

# Table of Contents

1	Ordering parts.....	4	5.3	Switching specifications.....	18
1.1	Determining valid order-able parts.....	4	5.3.1	Device clock specifications.....	18
2	Part identification.....	4	5.3.2	General switching specifications.....	18
2.1	Description.....	4	5.4	Thermal specifications.....	19
2.2	Format.....	4	5.4.1	Thermal operating requirements.....	19
2.3	Fields.....	4	5.4.2	Thermal attributes.....	19
2.4	Example.....	5	6	Peripheral operating requirements and behaviors.....	20
3	Terminology and guidelines.....	5	6.1	Core modules.....	21
3.1	Definition: Operating requirement.....	5	6.1.1	Single Wire Debug (SWD).....	21
3.2	Definition: Operating behavior.....	6	6.1.2	Analog Front End (AFE).....	21
3.3	Definition: Attribute.....	6	6.2	Clock modules.....	22
3.4	Definition: Rating.....	6	6.2.1	MCG specifications.....	22
3.5	Result of exceeding a rating.....	7	6.2.2	Oscillator electrical specifications.....	24
3.6	Relationship between ratings and operating requirements.....	7	6.2.3	32 kHz oscillator electrical characteristics.....	27
3.7	Guidelines for ratings and operating requirements.....	8	6.3	Memories and memory interfaces.....	28
3.8	Definition: Typical value.....	8	6.3.1	Flash electrical specifications.....	28
3.9	Typical value conditions.....	9	6.4	Analog.....	29
4	Ratings.....	10	6.4.1	ADC electrical specifications.....	29
4.1	Thermal handling ratings.....	10	6.4.2	CMP and 6-bit DAC electrical specifications.....	33
4.2	Moisture handling ratings.....	10	6.4.3	Voltage reference electrical specifications.....	35
4.3	ESD handling ratings.....	10	6.4.4	AFE electrical specifications.....	37
4.4	Voltage and current operating ratings.....	11	6.5	Timers.....	41
5	General.....	11	6.6	Communication interfaces.....	41
5.1	AC electrical characteristics.....	11	6.6.1	I2C switching specifications.....	41
5.2	Nonswitching electrical specifications.....	11	6.6.2	UART switching specifications.....	41
5.2.1	Voltage and current operating requirements.....	11	6.6.3	SPI switching specifications.....	41
5.2.2	LVD and POR operating requirements.....	12	6.7	Human-Machine Interfaces (HMI).....	44
5.2.3	Voltage and current operating behaviors.....	13	6.7.1	LCD electrical characteristics.....	44
5.2.4	Power mode transition operating behaviors.....	14	7	Dimensions.....	45
5.2.5	Power consumption operating behaviors.....	15	7.1	Obtaining package dimensions.....	46
5.2.6	EMC radiated emissions operating behaviors.....	17	8	Pinout.....	46
5.2.7	Designing with radiated emissions in mind.....	17	8.1	Package Types.....	46
5.2.8	Capacitance attributes.....	18	8.2	KM Signal Multiplexing and Pin Assignments.....	47
			8.3	KM Family Pinouts.....	49

## 1 Ordering parts

### 1.1 Determining valid order-able parts

Valid order-able part numbers are provided on the web. To determine the order-able part numbers for this device, go to [freescale.com](http://freescale.com) and perform a part number search for the following device numbers:

- MKM14Z64ACHH5
- MKM14Z128ACHH5
- MKM33Z64ACLH5
- MKM33Z128ACLH5
- MKM33Z64ACLL5
- MKM33Z128ACLL5
- MKM34Z128ACLL5

#### NOTE

It is recommended to order the RevA part numbers for the KM parts.

## 2 Part identification

### 2.1 Description

Part numbers for the chip have fields that identify the specific part. You can use the values of these fields to determine the specific part you have received.

### 2.2 Format

Part numbers for this device have the following format:

Q K M S A FFF R T PP CC N

### 2.3 Fields

Following table lists the possible values for each field in the part number (not all combinations are valid):

Field	Description	Values
Q	Qualification status	<ul style="list-style-type: none"> <li>M = Fully qualified, general market flow</li> <li>P = Pre-qualification (Proto)</li> </ul>
K	Main family	<ul style="list-style-type: none"> <li>K = Kinetis</li> </ul>
M	Sub family	<ul style="list-style-type: none"> <li>M1 = Metering only (No LCD support)</li> <li>M3 = Metering with LCD support</li> </ul>
S	Number of Sigma Delta (SD) ADC	<ul style="list-style-type: none"> <li>3 = 2 SD ADC with PGA and 1 SD ADC</li> <li>4 = 2 SD ADC with PGA and 2 SD ADC</li> </ul>
A	Key attribute	<ul style="list-style-type: none"> <li>Z = Cortex-M0+</li> </ul>
FFF	Program flash memory size	<ul style="list-style-type: none"> <li>64 = 64 KB</li> <li>128 = 128 KB</li> </ul>
R	Silicon revision	<ul style="list-style-type: none"> <li>Z = Initial</li> <li>(Blank) = Main</li> <li>A = Second revision</li> </ul>
T	Temperature range (°C)	<ul style="list-style-type: none"> <li>C = -40 to 85</li> </ul>
PP	Package identifier	<ul style="list-style-type: none"> <li>HH = 44 LGA (5 mm x 5 mm)</li> <li>LH = 64 LQFP (10 mm x 10 mm)</li> <li>LL = 100 LQFP (14 mm x 14 mm)</li> </ul>
CC	Maximum CPU frequency (MHz)	<ul style="list-style-type: none"> <li>5 = 50 MHz</li> </ul>
N	Packaging type	<ul style="list-style-type: none"> <li>R = Tape and reel</li> <li>(Blank) = Trays</li> </ul>

## 2.4 Example

This is an example part number:

- MKM34Z128CLL5

## 3 Terminology and guidelines

### 3.1 Definition: Operating requirement

An *operating requirement* is a specified value or range of values for a technical characteristic that you must guarantee during operation to avoid incorrect operation and possibly decreasing the useful life of the chip.

#### 3.1.1 Example

This is an example of an operating requirement:

## Terminology and guidelines

Symbol	Description	Min.	Max.	Unit
$V_{DD}$	1.0 V core supply voltage	0.9	1.1	V

### 3.2 Definition: Operating behavior

Unless otherwise specified, an *operating behavior* is a specified value or range of values for a technical characteristic that are guaranteed during operation if you meet the operating requirements and any other specified conditions.

#### 3.2.1 Example

This is an example of an operating behavior:

Symbol	Description	Min.	Max.	Unit
$I_{WP}$	Digital I/O weak pullup/pulldown current	10	130	$\mu\text{A}$

### 3.3 Definition: Attribute

An *attribute* is a specified value or range of values for a technical characteristic that are guaranteed, regardless of whether you meet the operating requirements.

#### 3.3.1 Example

This is an example of an attribute:

Symbol	Description	Min.	Max.	Unit
$C_{IN\_D}$	Input capacitance: digital pins	—	7	pF

### 3.4 Definition: Rating

A *rating* is a minimum or maximum value of a technical characteristic that, if exceeded, may cause permanent chip failure:

- *Operating ratings* apply during operation of the chip.
- *Handling ratings* apply when the chip is not powered.

### 3.4.1 Example

This is an example of an operating rating:

Symbol	Description	Min.	Max.	Unit
V <sub>DD</sub>	1.0 V core supply voltage	-0.3	1.2	V

### 3.5 Result of exceeding a rating

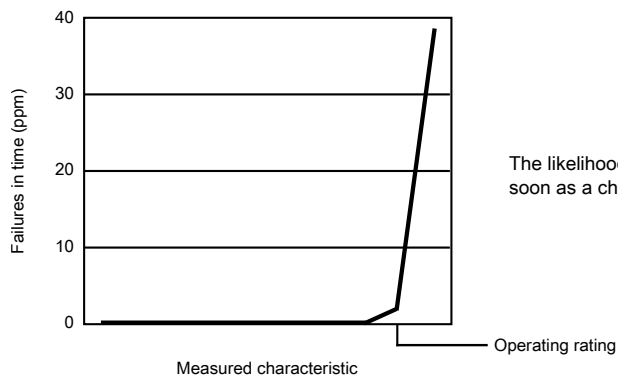

The likelihood of permanent chip failure increases rapidly as soon as a characteristic begins to exceed one of its operating ratings.

### 3.6 Relationship between ratings and operating requirements

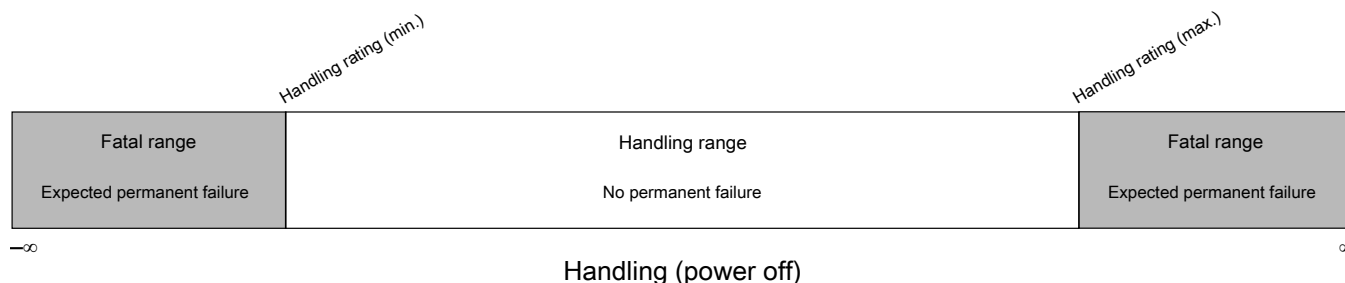
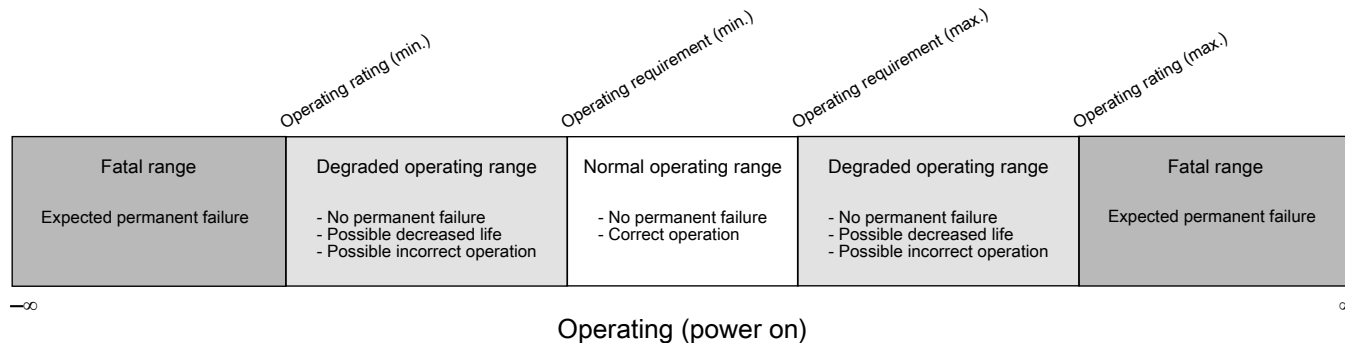

### 3.7 Guidelines for ratings and operating requirements

Follow these guidelines for ratings and operating requirements:

- Never exceed any of the chip’s ratings.
- During normal operation, don’t exceed any of the chip’s operating requirements.
- If you must exceed an operating requirement at times other than during normal operation (for example, during power sequencing), limit the duration as much as possible.

### 3.8 Definition: Typical value

A *typical value* is a specified value for a technical characteristic that:

- Lies within the range of values specified by the operating behavior
- Given the typical manufacturing process, is representative of that characteristic during operation when you meet the typical-value conditions or other specified conditions

Typical values are provided as design guidelines and are neither tested nor guaranteed.



### 3.8.1 Example 1

This is an example of an operating behavior that includes a typical value:

Symbol	Description	Min.	Typ.	Max.	Unit
$I_{WP}$	Digital I/O weak pullup/pulldown current	10	70	130	$\mu\text{A}$

### 3.8.2 Example 2

This is an example of a chart that shows typical values for various voltage and temperature conditions:

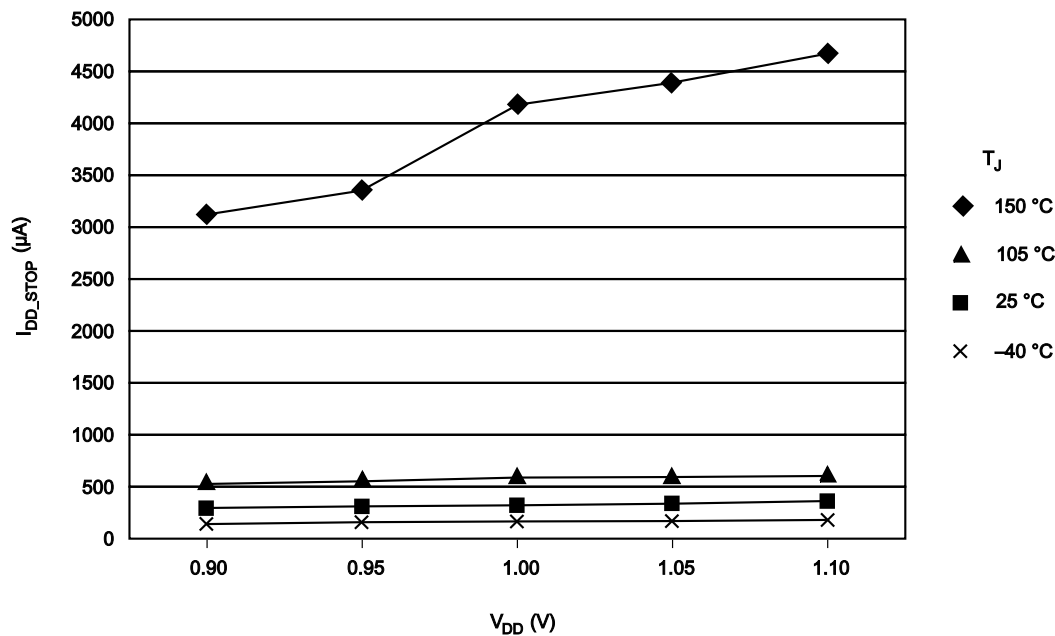

## 3.9 Typical value conditions

Typical values assume you meet the following conditions (or other conditions as specified):

Symbol	Description	Value	Unit
$T_A$	Ambient temperature	25	$^{\circ}\text{C}$
$V_{DD}$	3.3 V supply voltage	3.3	V

## 4 Ratings

### 4.1 Thermal handling ratings

Symbol	Description	Min.	Max.	Unit	Notes
T <sub>STG</sub>	Storage temperature	-55	150	°C	1
T <sub>SDR</sub>	Solder temperature, lead-free	—	260	°C	2

1. Determined according to JEDEC Standard JESD22-A103, *High Temperature Storage Life*.
2. Determined according to IPC/JEDEC Standard J-STD-020, *Moisture/Reflow Sensitivity Classification for Nonhermetic Solid State Surface Mount Devices*.

### 4.2 Moisture handling ratings

Symbol	Description	Min.	Max.	Unit	Notes
MSL	Moisture sensitivity level	—	3	—	1

1. Determined according to IPC/JEDEC Standard J-STD-020, *Moisture/Reflow Sensitivity Classification for Nonhermetic Solid State Surface Mount Devices*.

### 4.3 ESD handling ratings

Symbol	Description	Min.	Max.	Unit	Notes
V <sub>HBM</sub>	Electrostatic discharge voltage, human body model (All pins except RESET pin)	-4000	+4000	V	1
	Electrostatic discharge voltage, human body model (RESET pin only)	-2500	+2500	V	1
V <sub>CDM</sub>	Electrostatic discharge voltage, charged-device model (for corner pins)	-750	+750	V	2
V <sub>CDM</sub>	Electrostatic discharge voltage, charged-device model	-500	+500	V	3
V <sub>PESD</sub>	Powered ESD voltage	-6000	+6000	V	
I <sub>LAT</sub>	Latch-up current at ambient temperature of 105°C	-100	+100	mA	

1. Determined according to JEDEC Standard JESD22-A114, *Electrostatic Discharge (ESD) Sensitivity Testing Human Body Model (HBM)*.
2. Determined according to JEDEC Standard JESD22-C101, *Field-Induced Charged-Device Model Test Method for Electrostatic-Discharge-Withstand Thresholds of Microelectronic Components*.
3. Determined according to JEDEC Standard JESD22-C101, *Field-Induced Charged-Device Model Test Method for Electrostatic-Discharge-Withstand Thresholds of Microelectronic Components*.

## 4.4 Voltage and current operating ratings

Symbol	Description	Min.	Max.	Unit
$V_{DD}$	Digital supply voltage	-0.3	3.6	V
$V_{DIO}$	Digital input voltage (except RESET, EXTAL, and XTAL)	-0.3	$V_{DD} + 0.3$	V
$V_{DTamper}$	Tamper input voltage	-0.3	$V_{BAT} + 0.3$	V
$V_{AIO}$	Analog <sup>1</sup> , RESET, EXTAL, and XTAL input voltage	-0.3	$V_{DD} + 0.3$	V
$I_D$	Instantaneous maximum current single pin limit (applies to all port pins)	-25	25	mA
$V_{DDA}$	Analog supply voltage	$V_{DD} - 0.3$	$V_{DD} + 0.3$	V
$V_{BAT}$	RTC battery supply voltage	-0.3	3.6	V

1. Analog pins are defined as pins that do not have an associated general purpose I/O port function.

## 5 General

### 5.1 AC electrical characteristics

Unless otherwise specified, propagation delays are measured from the 50% to the 50% point, and rise and fall times are measured at the 20% and 80% points, as shown in the following figure.

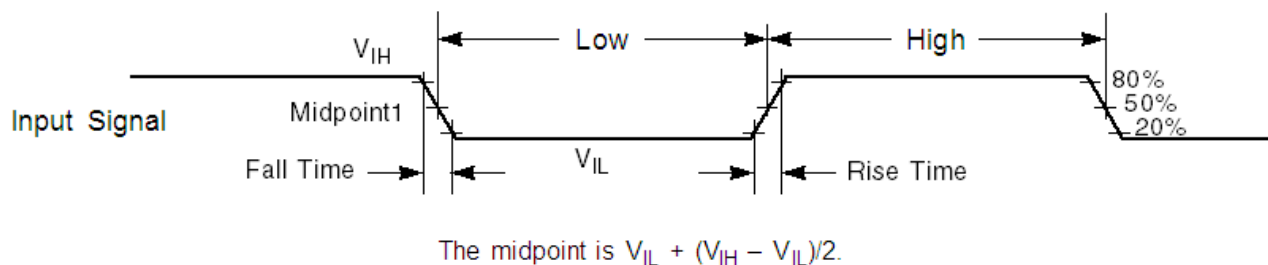

Figure 1. Input signal measurement reference

### 5.2 Nonswitching electrical specifications

## 5.2.1 Voltage and current operating requirements

**Table 1. Voltage and current operating requirements**

Symbol	Description	Min.	Max.	Unit	Notes
V <sub>DD</sub>	Supply voltage when AFE is operational	2.7	3.6	V	
	Supply voltage when AFE is NOT operational	1.71	3.6	V	
V <sub>DDA</sub>	Analog supply voltage	2.7	3.6	V	
V <sub>DD</sub> - V <sub>DDA</sub>	V <sub>DD</sub> -to-V <sub>DDA</sub> differential voltage	-0.1	0.1	V	
V <sub>SS</sub> - V <sub>SSA</sub>	V <sub>SS</sub> -to-V <sub>SSA</sub> differential voltage	-0.1	0.1	V	
V <sub>BAT</sub>	RTC battery supply voltage	1.71	3.6	V	1
V <sub>IH</sub>	Input high voltage <ul style="list-style-type: none"> <li>• 2.7 V ≤ V<sub>DD</sub> ≤ 3.6 V</li> <li>• 1.7 V ≤ V<sub>DD</sub> ≤ 2.7 V</li> </ul>	0.7 × V <sub>DD</sub>	—	V	
		0.75 × V <sub>DD</sub>	—	V	
V <sub>IL</sub>	Input low voltage <ul style="list-style-type: none"> <li>• 2.7 V ≤ V<sub>DD</sub> ≤ 3.6 V</li> <li>• 1.7 V ≤ V<sub>DD</sub> ≤ 2.7 V</li> </ul>	—	0.35 × V <sub>DD</sub>	V	
		—	0.3 × V <sub>DD</sub>	V	
V <sub>HYS</sub>	Input hysteresis	0.06 × V <sub>DD</sub>	—	V	
I <sub>CDIO</sub>	Digital pin negative DC injection current — single pin <ul style="list-style-type: none"> <li>• V<sub>IN</sub> &lt; V<sub>SS</sub>-0.3V</li> </ul>	-5	—	mA	
I <sub>CAIO</sub>	Analog <sup>2</sup> , EXTAL, and XTAL pin DC injection current — single pin <ul style="list-style-type: none"> <li>• V<sub>IN</sub> &lt; V<sub>SS</sub>-0.3V (Negative current injection)</li> <li>• V<sub>IN</sub> &gt; V<sub>DD</sub>+0.3V (Positive current injection)</li> </ul>	-3	—	mA	
		—	+3		
I <sub>Ccont</sub>	Contiguous pin DC injection current — regional limit, includes sum of negative injection currents or sum of positive injection currents of 16 contiguous pins <ul style="list-style-type: none"> <li>• Negative current injection</li> <li>• Positive current injection</li> </ul>	-25	—	mA	
		—	+25		
V <sub>RFVBAT</sub>	V <sub>BAT</sub> voltage required to retain the VBAT register file	V <sub>POR_VBAT</sub>	—	V	

1. V<sub>BAT</sub> always needs to be there for the chip to be operational.
2. Analog pins are defined as pins that do not have an associated general purpose I/O port function.

## 5.2.2 LVD and POR operating requirements

**Table 2. V<sub>DD</sub> supply LVD and POR operating requirements**

Symbol	Description	Min.	Typ.	Max.	Unit	Notes
V <sub>POR</sub>	Falling VDD POR detect voltage	0.8	1.1	1.5	V	
V <sub>LVDH</sub>	Falling low-voltage detect threshold — high range (LVDV=01)	2.48	2.56	2.64	V	

Table continues on the next page...

**Table 2. V<sub>DD</sub> supply LVD and POR operating requirements (continued)**

Symbol	Description	Min.	Typ.	Max.	Unit	Notes
V <sub>LVW1H</sub>	Low-voltage warning thresholds — high range					1
	<ul style="list-style-type: none"> <li>Level 1 falling (LVWV=00)</li> </ul>	2.62	2.70	2.78	V	
V <sub>LVW2H</sub>	<ul style="list-style-type: none"> <li>Level 2 falling (LVWV=01)</li> </ul>	2.72	2.80	2.88	V	
V <sub>LVW3H</sub>	<ul style="list-style-type: none"> <li>Level 3 falling (LVWV=10)</li> </ul>	2.82	2.90	2.98	V	
V <sub>LVW4H</sub>	<ul style="list-style-type: none"> <li>Level 4 falling (LVWV=11)</li> </ul>	2.92	3.00	3.08	V	
V <sub>HYSH</sub>	Low-voltage inhibit reset/recover hysteresis — high range	—	80	—	mV	
V <sub>LVDL</sub>	Falling low-voltage detect threshold — low range (LVDV=00)	1.54	1.60	1.66	V	
V <sub>LVW1L</sub>	Low-voltage warning thresholds — low range					1
	<ul style="list-style-type: none"> <li>Level 1 falling (LVWV=00)</li> </ul>	1.74	1.80	1.86	V	
V <sub>LVW2L</sub>	<ul style="list-style-type: none"> <li>Level 2 falling (LVWV=01)</li> </ul>	1.84	1.90	1.96	V	
V <sub>LVW3L</sub>	<ul style="list-style-type: none"> <li>Level 3 falling (LVWV=10)</li> </ul>	1.94	2.00	2.06	V	
V <sub>LVW4L</sub>	<ul style="list-style-type: none"> <li>Level 4 falling (LVWV=11)</li> </ul>	2.04	2.10	2.16	V	
V <sub>HYSL</sub>	Low-voltage inhibit reset/recover hysteresis — low range	—	60	—	mV	
V <sub>BG</sub>	Bandgap voltage reference	0.97	1.00	1.03	V	
t <sub>LPO</sub>	Internal low power oscillator period — factory trimmed	900	1000	1100	μs	

1. Rising threshold is the sum of falling threshold and hysteresis voltage

**Table 3. VBAT power operating requirements**

Symbol	Description	Min.	Typ.	Max.	Unit	Notes
V <sub>POR_VBAT</sub>	Falling VBAT supply POR detect voltage	0.8	1.1	1.5	V	

### 5.2.3 Voltage and current operating behaviors

**Table 4. Voltage and current operating behaviors**

Symbol	Description	Min.	Max.	Unit	Notes
V <sub>OH</sub>	Output high voltage — high-drive strength				
	<ul style="list-style-type: none"> <li>2.7 V ≤ V<sub>DD</sub> ≤ 3.6 V, I<sub>OH</sub> = 20 mA</li> </ul>	V <sub>DD</sub> - 0.5	—	V	
	<ul style="list-style-type: none"> <li>1.71 V ≤ V<sub>DD</sub> ≤ 2.7 V, I<sub>OH</sub> = 10 mA</li> </ul>	V <sub>DD</sub> - 0.5	—	V	
	Output high voltage — low-drive strength				
	<ul style="list-style-type: none"> <li>2.7 V ≤ V<sub>DD</sub> ≤ 3.6 V, I<sub>OH</sub> = 5 mA</li> </ul>	V <sub>DD</sub> - 0.5	—	V	
	<ul style="list-style-type: none"> <li>1.71 V ≤ V<sub>DD</sub> ≤ 2.7 V, I<sub>OH</sub> = 2.5 mA</li> </ul>	V <sub>DD</sub> - 0.5	—	V	
I <sub>OHT</sub>	Output high current total for all ports	—	100	mA	

Table continues on the next page...

**Table 4. Voltage and current operating behaviors (continued)**

Symbol	Description	Min.	Max.	Unit	Notes
V <sub>OL</sub>	Output low voltage — high-drive strength				
	• 2.7 V ≤ V <sub>DD</sub> ≤ 3.6 V, I <sub>OL</sub> = 20 mA	—	0.5	V	
	• 1.71 V ≤ V <sub>DD</sub> ≤ 2.7 V, I <sub>OL</sub> = 10 mA	—	0.5	V	
	Output low voltage — low-drive strength				
	• 2.7 V ≤ V <sub>DD</sub> ≤ 3.6 V, I <sub>OL</sub> = 5 mA	—	0.5	V	
	• 1.71 V ≤ V <sub>DD</sub> ≤ 2.7 V, I <sub>OL</sub> = 2.5 mA	—	0.5	V	
I <sub>OLT</sub>	Output low current total for all ports	—	100	mA	
I <sub>OZ</sub>	Hi-Z (off-state) leakage current (per pin)	—	1	μA	
R <sub>PU</sub>	Internal pullup resistors	30	60	kΩ	1,
R <sub>PD</sub>	Internal pulldown resistors	30	60	kΩ	2

1. Measured at V<sub>input</sub> = V<sub>SS</sub>
2. Measured at V<sub>input</sub> = V<sub>DD</sub>

### 5.2.4 Power mode transition operating behaviors

All specifications except t<sub>POR</sub>, and VLLS<sub>x</sub>→RUN recovery times in the following table assume this clock configuration:

- CPU and system clocks = 50 MHz
- Bus clock = 25 MHz
- Flash clock = 25 MHz
- Temp: -40 °C, 25 °C, and 85 °C
- V<sub>DD</sub>: 1.71 V, 3.3 V, and 3.6 V

**Table 5. Power mode transition operating behaviors**

Symbol	Description	Min.	Max.	Unit	Notes
t <sub>POR</sub>	After a POR event, amount of time from the point V <sub>DD</sub> reaches 1.71 V to execute the first instruction across the operating temperature range of the chip.	563	659	μs	1
	• VLLS0 → RUN	—	372	μs	
	• VLLS1 → RUN	—	372	μs	
	• VLLS2 → RUN	—	273	μs	
	• VLLS3 → RUN	—	273	μs	
	• VLPS → RUN	—	5.0	μs	

Table continues on the next page...

**Table 5. Power mode transition operating behaviors (continued)**

Symbol	Description	Min.	Max.	Unit	Notes
	<ul style="list-style-type: none"> <li>• STOP → RUN</li> </ul>	—	5.0	μs	

1. Normal boot (FTFA\_OPT[LPBOOT]=1)

## 5.2.5 Power consumption operating behaviors

**Table 6. Power consumption operating behaviors**

Symbol	Description	Min.	Typ.	Max.	Unit	Notes
I <sub>DDA</sub>	Analog supply current	—	—	See note	mA	1
I <sub>DD_RUN</sub>	Run mode current — all peripheral clocks disabled, code executing from flash <ul style="list-style-type: none"> <li>• @ 3.0 V                             <ul style="list-style-type: none"> <li>• 25 °C</li> <li>• -40 °C</li> <li>• 105 °C</li> </ul> </li> </ul>	—	6.17	7.1	mA	2
I <sub>DD_RUN</sub>	Run mode current — all peripheral clocks enabled, code executing from flash <ul style="list-style-type: none"> <li>• @ 3.0 V                             <ul style="list-style-type: none"> <li>• 25 °C</li> <li>• -40 °C</li> <li>• 105 °C</li> </ul> </li> </ul>	—	8.24	10.4	mA	2
I <sub>DD_WAIT</sub>	Wait mode high frequency current at 3.0 V— all peripheral clocks disabled and Flash is not in low-power <ul style="list-style-type: none"> <li>• 25 °C</li> <li>• -40 °C</li> <li>• 105 °C</li> </ul>	—	3.95	4.65	mA	2
I <sub>DD_WAIT</sub>	Wait mode high frequency current at 3.0 V— all peripheral clocks disabled and Flash disabled (put in low-power) <ul style="list-style-type: none"> <li>• 25 °C</li> <li>• -40 °C</li> <li>• 105 °C</li> </ul>	—	3.81	4.4	mA	2, 3
I <sub>DD_VLPR</sub>	Very-low-power run mode current at 3.0 V — all peripheral clocks disabled <ul style="list-style-type: none"> <li>• 25 °C</li> <li>• -40 °C</li> <li>• 105 °C</li> </ul>	—	248.8	500	μA	4
I <sub>DD_VLPR</sub>	Very-low-power run mode current at 3.0 V — all peripheral clocks enabled <ul style="list-style-type: none"> <li>• 25 °C</li> <li>• -40 °C</li> <li>• 105 °C</li> </ul>	—	343.4	530	μA	5
I <sub>DD_VLPR</sub>	Very-low-power run mode current at 3.0 V — all peripheral clocks enabled <ul style="list-style-type: none"> <li>• 25 °C</li> <li>• -40 °C</li> <li>• 105 °C</li> </ul>	—	336.62	500	μA	
I <sub>DD_VLPR</sub>	Very-low-power run mode current at 3.0 V — all peripheral clocks enabled <ul style="list-style-type: none"> <li>• 25 °C</li> <li>• -40 °C</li> <li>• 105 °C</li> </ul>	—	626.18	2000	μA	

Table continues on the next page...

**Table 6. Power consumption operating behaviors (continued)**

Symbol	Description	Min.	Typ.	Max.	Unit	Notes
I <sub>DD_VLPW</sub>	Very-low-power wait mode current at 3.0 V — all peripheral clocks disabled <ul style="list-style-type: none"> <li>• 25 °C</li> <li>• -40 °C</li> <li>• 105 °C</li> </ul>	—	162	350	μA	6
		—	158.50	330	μA	
		—	446.94	1700	μA	
I <sub>DD_STOP</sub>	Stop mode current at 3.0 V <ul style="list-style-type: none"> <li>• 25 °C</li> <li>• -40 °C</li> <li>• 105 °C</li> </ul>	—	311.90	730	μA	
		—	364	700	μA	
		—	645.13	2250	μA	
I <sub>DD_VLPS</sub>	Very-low-power stop mode current at 3.0 V <ul style="list-style-type: none"> <li>• 25 °C</li> <li>• -40 °C</li> <li>• 105 °C</li> </ul>	—	8.56	46	μA	
		—		44	μA	
		—		1500	μA	
I <sub>DD_VLLS3</sub>	Very low-leakage stop mode 3 current at 3.0 V <ul style="list-style-type: none"> <li>• 25 °C</li> <li>• -40 °C</li> <li>• 105 °C</li> </ul>	—	1.98	3.5	μA	
		—		3.3	μA	
		—		85	μA	
I <sub>DD_VLLS2</sub>	Very low-leakage stop mode 2 current at 3.0 V <ul style="list-style-type: none"> <li>• 25 °C</li> <li>• -40 °C</li> <li>• 105 °C</li> </ul>	—	1.24	2.6	μA	
		—		2.5	μA	
		—		59.5	μA	
I <sub>DD_VLLS1</sub>	Very low-leakage stop mode 1 current at 3.0 V <ul style="list-style-type: none"> <li>• 25 °C</li> <li>• -40 °C</li> <li>• 105 °C</li> </ul>	—	0.89	1.7	μA	
		—		1.6	μA	
		—		38.8	μA	
I <sub>DD_VLLS0</sub>	Very low-leakage stop mode 0 current at 3.0 V with POR detect circuit disabled <ul style="list-style-type: none"> <li>• 25 °C</li> <li>• -40 °C</li> <li>• 105 °C</li> </ul>	—	0.35	0.67	μA	
		—		0.64	μA	
		—		38	μA	
I <sub>DD_VLLS0</sub>	Very low-leakage stop mode 0 current at 3.0 V with POR detect circuit enabled <ul style="list-style-type: none"> <li>• 25 °C</li> <li>• -40 °C</li> <li>• 105 °C</li> </ul>	—	0.472	0.76	μA	
		—		0.72	μA	
		—		38.4	μA	
I <sub>DD_VBAT</sub>	Average current with RTC and 32 kHz disabled at 3.0 V and VDD is OFF <ul style="list-style-type: none"> <li>• 25 °C</li> <li>• -40 °C</li> <li>• 105 °C</li> </ul>	—	0.3	1	μA	
		—		0.95	μA	
		—		15	μA	

Table continues on the next page...



**Table 6. Power consumption operating behaviors (continued)**

Symbol	Description	Min.	Typ.	Max.	Unit	Notes
I <sub>DD_VBAT</sub>	Average current when VDD is OFF and LFSR and Tamper clocks set to 2 Hz. <ul style="list-style-type: none"> <li>• @ 3.0 V                             <ul style="list-style-type: none"> <li>• 25 °C</li> <li>• -40 °C</li> <li>• 105 °C</li> </ul> </li> </ul>	—	1.3 <sup>7</sup>	3	μA	8, 9
				2.5	μA	
				16	μA	

- See AFE specification for IDDA.
- 50 MHz core and system clock, 25 MHz bus clock, and 25 MHz flash clock. MCG configured for FBE mode. All peripheral clocks disabled.
- Should be reduced by 500 μA.
- 2 MHz core, system, bus clock, and 1 MHz flash clock. MCG configured for BLPE mode. All peripheral clocks disabled. Code executing while (1) loop from flash.
- 2 MHz core, system and bus clock, and 1MHz flash clock. MCG configured for BLPE mode. All peripheral clocks enabled but peripherals are not in active operation. Code executing while (1) loop from flash.
- 2 MHz core, system and bus clock, and 1 MHz flash clock. MCG configured for BLPE mode. All peripheral clocks disabled. No flash accesses; some activity on DMA & RAM assumed.
- Current consumption will vary with number of CPU accesses done and is dependent on the frequency of the accesses and frequency of bus clock. Number of CPU accesses should be optimized to get optimal current value.
- Includes 32 kHz oscillator current and RTC operation.
- An external power switch for VBAT should be present on board to have better battery life and keep VBAT pin powered in all conditions. There is no internal power switch in RTC.

## 5.2.6 EMC radiated emissions operating behaviors

**Table 7. EMC radiated emissions operating behaviors**

Symbol	Description	Frequency band (MHz)	Typ.	Unit	Notes
V <sub>RE1</sub>	Radiated emissions voltage, band 1	0.15–50	14	dBμV	1, 2
V <sub>RE2</sub>	Radiated emissions voltage, band 2	50–150	16	dBμV	
V <sub>RE3</sub>	Radiated emissions voltage, band 3	150–500	12	dBμV	
V <sub>RE4</sub>	Radiated emissions voltage, band 4	500–1000	5	dBμV	
V <sub>RE_IEC</sub>	IEC level	0.15–1000	M	—	2, 3

- Determined according to IEC Standard 61967-1, *Integrated Circuits - Measurement of Electromagnetic Emissions, 150 kHz to 1 GHz Part 1: General Conditions and Definitions* and IEC Standard 61967-2, *Integrated Circuits - Measurement of Electromagnetic Emissions, 150 kHz to 1 GHz Part 2: Measurement of Radiated Emissions—TEM Cell and Wideband TEM Cell Method*. Measurements were made while the microcontroller was running basic application code. The reported emission level is the value of the maximum measured emission, rounded up to the next whole number, from among the measured orientations in each frequency range.
- V<sub>DD</sub> = 3.3 V, T<sub>A</sub> = 25 °C, f<sub>OSC</sub> = 10 MHz (crystal), f<sub>SYS</sub> = 50 MHz, f<sub>BUS</sub> = 25 MHz
- Specified according to Annex D of IEC Standard 61967-2, *Measurement of Radiated Emissions—TEM Cell and Wideband TEM Cell Method*

## 5.2.7 Designing with radiated emissions in mind

To find application notes that provide guidance on designing your system to minimize interference from radiated emissions:

1. Go to [www.freescale.com](http://www.freescale.com).
2. Perform a keyword search for “EMC design.”

## 5.2.8 Capacitance attributes

**Table 8. Capacitance attributes**

Symbol	Description	Min.	Max.	Unit
$C_{IN\_A}$	Input capacitance: analog pins	—	7	pF
$C_{IN\_D}$	Input capacitance: digital pins	—	7	pF
$C_{IN\_D\_io60}$	Input capacitance: fast digital pins	—	9	pF

## 5.3 Switching specifications

### 5.3.1 Device clock specifications

**Table 9. Device clock specifications**

Symbol	Description	Min.	Max.	Unit	Notes
Normal run mode					
$f_{SYS}$	System and core clock		50	MHz	
$f_{BUS}$	Bus clock		25	MHz	
$f_{FLASH}$	Flash clock		25	MHz	
$f_{AFE}$	AFE Modulator clock		6.5	MHz	
VLPR mode <sup>1</sup>					
$f_{SYS}$	System and core clock		2	MHz	
$f_{BUS}$	Bus clock		1	MHz	
$f_{FLASH}$	Flash clock		1	MHz	
$f_{AFE}$	AFE Modulator clock <sup>2</sup>		1.6	MHz	

1. The frequency limitations in VLPR mode here override any frequency specification listed in the timing specification for any other module.
2. AFE working in low-power mode.

## 5.3.2 General switching specifications

These general purpose specifications apply to all signals configured for GPIO, UART, and I<sup>2</sup>C signals.

**Table 10. General switching specifications**

Symbol	Description	Min.	Max.	Unit	Notes
	GPIO pin interrupt pulse width (digital glitch filter disabled) — Synchronous path	1.5	—	Bus clock cycles	1
	GPIO pin interrupt pulse width (digital glitch filter disabled) — Asynchronous path	16	—	ns	2
	External reset pulse width (digital glitch filter disabled)	100	—	ns	2
	Port rise and fall time—Low (All pins) and high drive (only PTC2) strength				3
	<ul style="list-style-type: none"> <li>• Slew disabled                             <ul style="list-style-type: none"> <li>• <math>1.71 \leq V_{DD} \leq 2.7 \text{ V}</math></li> <li>• <math>2.7 \leq V_{DD} \leq 3.6 \text{ V}</math></li> </ul> </li> <li>• Slew enabled                             <ul style="list-style-type: none"> <li>• <math>1.71 \leq V_{DD} \leq 2.7 \text{ V}</math></li> <li>• <math>2.7 \leq V_{DD} \leq 3.6 \text{ V}</math></li> </ul> </li> </ul>	—	8	ns	
		—	5	ns	
		—	27	ns	
		—	16	ns	

1. The greater synchronous and asynchronous timing must be met.
2. This is the shortest pulse that is guaranteed to be recognized.
3. Only PTC2 has high drive capability and load is 75 pF, other pins load (low drive) is 25 pF.

## 5.4 Thermal specifications

### 5.4.1 Thermal operating requirements

**Table 11. Thermal operating requirements**

Symbol	Description	Min.	Max.	Unit	Notes
T <sub>J</sub>	Die junction temperature	−40	105	°C	
T <sub>A</sub>	Ambient temperature	−40	85	°C	1

1. Maximum T<sub>A</sub> can be exceeded only if the user ensures that T<sub>J</sub> does not exceed the maximum. The simplest method to determine T<sub>J</sub> is:  $T_J = T_A + \theta_{JA} \times \text{chip power dissipation}$

## 5.4.2 Thermal attributes

Board type	Symbol	Description	100 LQFP	44 LGA	Unit	Notes
Single-layer (1s)	$R_{\theta JA}$	Thermal resistance, junction to ambient (natural convection)	63	95	°C/W	1
Four-layer (2s2p)	$R_{\theta JA}$	Thermal resistance, junction to ambient (natural convection)	50	50	°C/W	1
Single-layer (1s)	$R_{\theta JMA}$	Thermal resistance, junction to ambient (200 ft./min. air speed)	53	79	°C/W	1
Four-layer (2s2p)	$R_{\theta JMA}$	Thermal resistance, junction to ambient (200 ft./min. air speed)	44	45	°C/W	1
—	$R_{\theta JB}$	Thermal resistance, junction to board	36	35	°C/W	2
—	$R_{\theta JC}$	Thermal resistance, junction to case	18	28	°C/W	3
—	$\Psi_{JT}$	Thermal characterization parameter, junction to package top outside center (natural convection)	3	4	°C/W	4

1. Determined according to JEDEC Standard JESD51-2, *Integrated Circuits Thermal Test Method Environmental Conditions—Natural Convection (Still Air)*, or EIA/JEDEC Standard JESD51-6, *Integrated Circuit Thermal Test Method Environmental Conditions—Forced Convection (Moving Air)*.
2. Determined according to JEDEC Standard JESD51-8, *Integrated Circuit Thermal Test Method Environmental Conditions—Junction-to-Board*.
3. Determined according to Method 1012.1 of MIL-STD 883, *Test Method Standard, Microcircuits*, with the cold plate temperature used for the case temperature. The value includes the thermal resistance of the interface material between the top of the package and the cold plate.
4. Determined according to JEDEC Standard JESD51-2, *Integrated Circuits Thermal Test Method Environmental Conditions—Natural Convection (Still Air)*.

## 6 Peripheral operating requirements and behaviors

## 6.1 Core modules

### 6.1.1 Single Wire Debug (SWD)

**Table 12. SWD switching characteristics at 2.7 V (2.7-3.6 V)**

Symbol	Description	Value	Unit	Notes
SWD CLK	Frequency of SWD operation	20	MHz	1
Inputs, tSUI	Data setup time	5	ns	1
inputs,tHI	Data hold time	0	ns	1
after clock edge, tDVO	Data valid Time	32	ns	1
tHO	Data Valid Hold	0	ns	1

1. Input transition assumed = 1 ns. Output transition assumed = 50 pf.

**Table 13. Switching characteristics at 1.7 V (1.7-3.6 V)**

Symbol	Description	Value	Unit	Notes
SWD CLK	Frequency of SWD operation	18	MHz	
Inputs, tSUI	Data setup time	4.7	ns	
inputs,tHI	Data hold time	0	ns	
after clock edge, tDVO	Data valid Time	49.4	ns	2
tHO	Data Valid Hold	0	ns	

1. Frequency of SWD clock (18 Mhz) is applicable only in case the input setup time of the device outside is not more than 6.15 ns, else the frequency of SWD clock would need to be lowered.

### 6.1.2 Analog Front End (AFE)

#### AFE switching characteristics at (2.7 V-3.6 V)

**Case1:** Clock is coming In and Data is also coming In (XBAR ports timed with respect to the XBAR ports timed with respect to AFE clock defined at pad ptb[7] and pte[3])

**Table 14. AFE switching characteristics (2.7 V-3.6 V)**

Symbol	Description	Value	Unit	Notes
AFE CLK	Frequency of operation	10	MHz	1
Inputs, tSUI	Data setup time	5	ns	1
inputs,tHI	Data hold time	0	ns	1

1. Input Transition: 1ns. Output Load: 50 pf.

**Case 2:** Clock is going Out and Data is coming In (XBAR ports timed with respect to generated clock defined at the XBAR out ports)

**Table 15. AFE switching characteristics (2.7V-3.6V)**

Symbol	Description	Value	Unit	Notes
AFE CLK	Frequency of operation	6.2	MHz	
Inputs, tSUI	Data setup time	36	ns	
inputs, tHI	Data hold time	0	ns	

### AFE switching characteristics at (1.7 V-3.6 V)

**Case1:** Clock is coming In and Data is also coming In ( XBAR ports timed with respect to AFE clock defined at pad ptb[7] and pte[3])

**Table 16. AFE switching characteristics (1.7 V-3.6 V)**

Symbol	Description	Value	Unit	Notes
AFE CLK	Frequency of operation	10	MHz	
Inputs, tSUI	Data setup time	5.1	ns	
inputs, tHI	Data hold time	0	ns	

**Case 2:** Clock is going Out and Data is coming In ( XBAR ports timed with respect to generated clock defined at XBAR out ports)

**Table 17. AFE switching characteristics (1.7 V-3.6 V)**

Symbol	Description	Value	Unit	Notes
AFE CLK	Frequency of operation	6.2	MHz	
Inputs, tSUI	Data setup time	54	ns	
inputs, tHI	Data hold time	0	ns	

## 6.2 Clock modules

### 6.2.1 MCG specifications

**Table 18. MCG specifications**

Symbol	Description	Min.	Typ.	Max.	Unit	Notes
f <sub>ints_ft</sub>	Internal reference frequency (slow clock) — factory trimmed at nominal VDD and 25 °C	—	32.768	—	kHz	

*Table continues on the next page...*

**Table 18. MCG specifications (continued)**

Symbol	Description	Min.	Typ.	Max.	Unit	Notes	
$\Delta f_{\text{ints\_t}}$	Total deviation of internal reference frequency (slow clock) over voltage and temperature	—	+0.5/-0.7	—	%		
$\Delta f_{\text{ints\_t}}$	Total deviation of internal reference frequency (slow clock) over fixed voltage and full operating temperature range	-2	—	+2	%		
$f_{\text{ints\_t}}$	Internal reference frequency (slow clock) — user trimmed	31.25	—	39.0625	kHz		
$\Delta f_{\text{dco\_res\_t}}$	Resolution of trimmed average DCO output frequency at fixed voltage and temperature — using SCTRIM and SCFTRIM	—	$\pm 0.3$	$\pm 0.6$	% $f_{\text{dco}}$	1	
$\Delta f_{\text{dco\_t}}$	Total deviation of trimmed average DCO output frequency over voltage and temperature	—	+0.5/-0.7	—	% $f_{\text{dco}}$	1	
$\Delta f_{\text{dco\_t}}$	Total deviation of trimmed average DCO output frequency over fixed voltage and temperature range of 0–70°C	—	$\pm 0.4$	—	% $f_{\text{dco}}$	1	
$f_{\text{intf\_ft}}$	Internal reference frequency (fast clock) — factory trimmed at nominal VDD and 25°C	—	4	—	MHz		
$\Delta f_{\text{intf\_t}}$	Total deviation of internal reference frequency (fast clock) over voltage and temperature — factory trimmed at nominal VDD and 25°C	—	+1/-2	—	%		
$f_{\text{intf\_t}}$	Internal reference frequency (fast clock) — user trimmed at nominal VDD and 25 °C	3	—	5	MHz		
$f_{\text{loc\_low}}$	Loss of external clock minimum frequency — RANGE = 00	$(3/5) \times f_{\text{ints\_t}}$	—	—	kHz		
$f_{\text{loc\_high}}$	Loss of external clock minimum frequency — RANGE = 01, 10, or 11	$(16/5) \times f_{\text{ints\_t}}$	—	—	kHz		
FLL							
$f_{\text{dco}}$	DCO output frequency range	Low-range (DRS=00) $640 \times f_{\text{ints\_t}}$	20	20.97	22	MHz	2, 3
		Mid-range (DRS=01) $1280 \times f_{\text{ints\_t}}$	40	41.94	45	MHz	
		Mid-high range (DRS=10) $1920 \times f_{\text{ints\_t}}$	60	62.91	67	MHz	
		High-range (DRS=11) $2560 \times f_{\text{ints\_t}}$	80	83.89	90	MHz	

Table continues on the next page...

**Table 18. MCG specifications (continued)**

Symbol	Description	Min.	Typ.	Max.	Unit	Notes	
f <sub>dco_t_DMx32</sub>	DCO output frequency	Low-range (DRS=00) $732 \times f_{ints\_t}$	—	23.99	—	MHz	4, 5, 6
		Mid-range (DRS=01) $1464 \times f_{ints\_t}$	—	47.97	—	MHz	
		Mid-high range (DRS=10) $2197 \times f_{ints\_t}$	—	71.99	—	MHz	
		High-range (DRS=11) $2929 \times f_{ints\_t}$	—	95.98	—	MHz	
J <sub>cyc_fill</sub>	FLL period jitter	—	70	140	ps	7	
t <sub>fl_acquire</sub>	FLL target frequency acquisition time	—	—	1	ms	8	
PLL							
f <sub>vco</sub>	VCO operating frequency	11.71875	12.288	14.6484375	MHz		
I <sub>pll</sub>	PLL operating current • IO 3.3 V current • Max core voltage current	—	300 100	—	μA	9	
f <sub>pll_ref</sub>	PLL reference frequency range	31.25	32.768	39.0625	kHz		
J <sub>cyc_pll</sub>	PLL period jitter (RMS) • f <sub>vco</sub> = 12 MHz			700	ps	10	
D <sub>lock</sub>	Lock entry frequency tolerance	± 1.49	—	± 2.98	%	11	
D <sub>unl</sub>	Lock exit frequency tolerance	± 4.47	—	± 5.97	%		
t <sub>pll_lock</sub>	Lock detector detection time	—	—	$150 \times 10^{-6} + 1075(1/f_{pll\_ref})$	s	12	

1. This parameter is measured with the internal reference (slow clock) being used as a reference to the FLL (FEI clock mode).
2. These typical values listed are with the slow internal reference clock (FEI) using factory trim and DMX32=0.
3. Chip max freq is 5075 MHz, so Mid-range with DRS = 10 and High-range of DCO cannot be used and should not be configured.
4. These typical values listed are with the slow internal reference clock (FEI) using factory trim and DMX32=1.
5. The resulting clock frequency must not exceed the maximum specified clock frequency of the device.
6. Chip max freq is 5075 MHz, so Mid-range with DRS = 10 and High-range of DCO cannot be used and should not be configured.
7. This specification is based on standard deviation (RMS) of period or frequency.
8. This specification applies to any time the FLL reference source or reference divider is changed, trim value is changed, DMX32 bit is changed, DRS bits are changed, or changing from FLL disabled (BLPE, BLPI) to FLL enabled (FEI, FEE, FBE, FBI). If a crystal/resonator is being used as the reference, this specification assumes it is already running.
9. Excludes any oscillator currents that are also consuming power while PLL is in operation.
10. This specification was obtained using a Freescale developed PCB. PLL jitter is dependent on the noise characteristics of each PCB and results will vary.
11. Will be updated later
12. This specification applies to any time the PLL VCO divider or reference divider is changed, or changing from PLL disabled (BLPE, BLPI) to PLL enabled (PBE, PEE). If a crystal/resonator is being used as the reference, this specification assumes it is already running.



## 6.2.2 Oscillator electrical specifications

### 6.2.2.1 Oscillator DC electrical specifications

Table 19. Oscillator DC electrical specifications

Symbol	Description	Min.	Typ.	Max.	Unit	Notes
$V_{DD}$	Supply voltage	1.71	—	3.6	V	
$I_{DDOSC}$	Supply current — low-power mode (HGO=0) <ul style="list-style-type: none"> <li>• 32 kHz</li> <li>• 1 MHz</li> <li>• 4 MHz</li> <li>• 8 MHz (RANGE=01)</li> <li>• 16 MHz</li> <li>• 24 MHz</li> <li>• 32 MHz</li> </ul>	—	500	—	nA	1
		—	200	—	$\mu$ A	
		—	200	—	$\mu$ A	
		—	300	—	$\mu$ A	
		—	950	—	$\mu$ A	
		—	1.2	—	mA	
		—	1.5	—	mA	
$I_{DDOSC}$	Supply current — high-gain mode (HGO=1) <ul style="list-style-type: none"> <li>• 32 kHz</li> <li>• 1 MHz</li> <li>• 4 MHz</li> <li>• 8 MHz (RANGE=01)</li> <li>• 16 MHz</li> <li>• 24 MHz</li> <li>• 32 MHz</li> </ul>	—	25	—	$\mu$ A	1
		—	300	—	$\mu$ A	
		—	400	—	$\mu$ A	
		—	500	—	$\mu$ A	
		—	2.5	—	mA	
		—	3	—	mA	
		—	4	—	mA	
$C_x$	EXTAL load capacitance	—	—	—		2, 3
$C_y$	XTAL load capacitance	—	—	—		2, 3
Capacitance of EXTAL	247 0.495 <ul style="list-style-type: none"> <li>• Die level (100 LQFP)</li> <li>• Package level (100 LQFP)</li> </ul>	—	—	ff pF		
	Capacitance of XTAL <ul style="list-style-type: none"> <li>• Die level (100 LQFP)</li> <li>• Package level (100 LQFP)</li> </ul>	265 0.495	—	—	ff pF	

Table continues on the next page...

**Table 19. Oscillator DC electrical specifications (continued)**

Symbol	Description	Min.	Typ.	Max.	Unit	Notes
R <sub>F</sub>	Feedback resistor — low-frequency, low-power mode (HGO=0)	—	—	—	MΩ	2, 4
	Feedback resistor — low-frequency, high-gain mode (HGO=1)	—	10	—	MΩ	
	Feedback resistor — high-frequency, low-power mode (HGO=0)	—	—	—	MΩ	
	Feedback resistor — high-frequency, high-gain mode (HGO=1)	—	1	—	MΩ	
R <sub>S</sub>	Series resistor — low-frequency, low-power mode (HGO=0)	—	—	—	kΩ	
	Series resistor — low-frequency, high-gain mode (HGO=1)	—	200	—	kΩ	
	Series resistor — high-frequency, low-power mode (HGO=0)	—	—	—	kΩ	
	Series resistor — high-frequency, high-gain mode (HGO=1)					
	<ul style="list-style-type: none"> <li>• 1 MHz resonator</li> <li>• 2 MHz resonator</li> <li>• 4 MHz resonator</li> <li>• 8 MHz resonator</li> <li>• 16 MHz resonator</li> <li>• 20 MHz resonator</li> <li>• 32 MHz resonator</li> </ul>	—	6.6	—	kΩ	
		—	3.3	—	kΩ	
		—	0	—	kΩ	
		—	0	—	kΩ	
V <sub>pp</sub> <sup>5</sup>	Peak-to-peak amplitude of oscillation (oscillator mode) — low-frequency, low-power mode (HGO=0)	—	0.6	—	V	
	Peak-to-peak amplitude of oscillation (oscillator mode) — low-frequency, high-gain mode (HGO=1)	—	V <sub>DD</sub>	—	V	
	Peak-to-peak amplitude of oscillation (oscillator mode) — high-frequency, low-power mode (HGO=0)	—	0.6	—	V	
	Peak-to-peak amplitude of oscillation (oscillator mode) — high-frequency, high-gain mode (HGO=1)	—	V <sub>DD</sub>	—	V	

1. V<sub>DD</sub>=3.3 V, Temperature =25 °C
2. See crystal or resonator manufacturer's recommendation
3. C<sub>x</sub> and C<sub>y</sub> can be provided by using either integrated capacitors or external components.
4. When low-power mode is selected, R<sub>F</sub> is integrated and must not be attached externally.
5. The EXTAL and XTAL pins should only be connected to required oscillator components and must not be connected to any other device.

## 6.2.2.2 Oscillator frequency specifications

**Table 20. Oscillator frequency specifications**

Symbol	Description	Min.	Typ.	Max.	Unit	Notes
$f_{osc\_lo}$	Oscillator crystal or resonator frequency — low-frequency mode (MCG_C2[RANGE]=00)	32	—	40	kHz	
$f_{osc\_hi\_1}$	Oscillator crystal or resonator frequency — high-frequency mode (low range) (MCG_C2[RANGE]=01)	1	—	8	MHz	
$f_{osc\_hi\_2}$	Oscillator crystal or resonator frequency — high frequency mode (high range) (MCG_C2[RANGE]=1x)	8	—	32	MHz	
$f_{ec\_extal}$	Input clock frequency (external clock mode)	—	—	48	MHz	1, 2
$t_{dc\_extal}$	Input clock duty cycle (external clock mode)	40	50	60	%	
$t_{cst}$	Crystal startup time — 32 kHz low-frequency, low-power mode (HGO=0)	—	—	—	ms	3, 4
	Crystal startup time — 32 kHz low-frequency, high-gain mode (HGO=1)	—	—	—	ms	
	Crystal startup time — 8 MHz high-frequency (MCG_C2[RANGE]=01), low-power mode (HGO=0)	—	0.6	—	ms	
	Crystal startup time — 8 MHz high-frequency (MCG_C2[RANGE]=01), high-gain mode (HGO=1)	—	1	—	ms	

1. Other frequency limits may apply when external clock is being used as a reference for the FLL or PLL.
2. When transitioning from FEI or FBI to FBE mode, restrict the frequency of the input clock so that, when it is divided by FRDIV, it remains within the limits of the DCO input clock frequency.
3. Proper PC board layout procedures must be followed to achieve specifications.
4. Crystal startup time is defined as the time between the oscillator being enabled and the OSCINIT bit in the MCG\_S register being set.

## 6.2.3 32 kHz oscillator electrical characteristics

### 6.2.3.1 32 kHz oscillator DC electrical specifications

**Table 21. 32kHz oscillator DC electrical specifications**

Symbol	Description	Min.	Typ.	Max.	Unit
$V_{BAT}$	Supply voltage	1.71	—	3.6	V
$R_F$	Internal feedback resistor	—	100	—	M $\Omega$
$C_{para}$	Parasitical capacitance of EXTAL32 and XTAL32	—	5	7	pF
$V_{pp}$ <sup>1</sup>	Peak-to-peak amplitude of oscillation	—	0.6	—	V

1. When a crystal is being used with the 32 kHz oscillator, the EXTAL32 and XTAL32 pins should only be connected to required oscillator components and must not be connected to any other devices.

### 6.2.3.2 32 kHz oscillator frequency specifications

**Table 22. 32 kHz oscillator frequency specifications**

Symbol	Description	Min.	Typ.	Max.	Unit	Notes
$f_{osc\_lo}$	Oscillator crystal	—	32.768	—	kHz	
$t_{start}$	Crystal start-up time	—	1000	—	ms	1
$V_{ec\_extal32}$	Externally provided input clock amplitude	700	—	$V_{BAT}$	mV	2, 3

1. Proper PC board layout procedures must be followed to achieve specifications.
2. This specification is for an externally supplied clock driven to EXTAL32 and does not apply to any other clock input. The oscillator remains enabled and XTAL32 must be left unconnected.
3. The parameter specified is a peak-to-peak value and  $V_{IH}$  and  $V_{IL}$  specifications do not apply. The voltage of the applied clock must be within the range of  $V_{SS}$  to  $V_{BAT}$ .

#### NOTE

The 32 kHz oscillator works in low power mode by default and cannot be moved into high power/gain mode.

## 6.3 Memories and memory interfaces

### 6.3.1 Flash electrical specifications

This section describes the electrical characteristics of the flash memory module.

#### 6.3.1.1 Flash timing specifications — program and erase

The following specifications represent the amount of time the internal charge pumps are active and do not include command overhead.

**Table 23. NVM program/erase timing specifications**

Symbol	Description	Min.	Typ.	Max.	Unit	Notes
$t_{hvp4}$	Longword Program high-voltage time	—	7.5	18	$\mu$ s	—
$t_{hversscr}$	Sector Erase high-voltage time	—	13	113	ms	1
$t_{hversall}$	Erase All high-voltage time	—	52	452	ms	1

1. Maximum time based on expectations at cycling end-of-life.

#### 6.3.1.2 Flash timing specifications — commands

**Table 24. Flash command timing specifications**

Symbol	Description	Min.	Typ.	Max.	Unit	Notes
$t_{rd1sec1k}$	Read 1s Section execution time (flash sector)	—	—	60	$\mu$ s	1

*Table continues on the next page...*

**Table 24. Flash command timing specifications (continued)**

Symbol	Description	Min.	Typ.	Max.	Unit	Notes
$t_{pgmchk}$	Program Check execution time	—	—	45	$\mu$ s	1
$t_{rdsrc}$	Read Resource execution time	—	—	30	$\mu$ s	1
$t_{pgm4}$	Program Longword execution time	—	65	145	$\mu$ s	—
$t_{ersscr}$	Erase Flash Sector execution time	—	14	114	ms	2
$t_{rd1all}$	Read 1s All Blocks execution time	—	—	1.8	ms	—
$t_{rdonce}$	Read Once execution time	—	—	25	$\mu$ s	1
$t_{pgmonce}$	Program Once execution time	—	65	—	$\mu$ s	—
$t_{ersall}$	Erase All Blocks execution time	—	88	650	ms	2
$t_{vfykey}$	Verify Backdoor Access Key execution time	—	—	30	$\mu$ s	1

1. Assumes 25 MHz flash clock frequency.
2. Maximum times for erase parameters based on expectations at cycling end-of-life.

### 6.3.1.3 Flash high voltage current behaviors

**Table 25. Flash high voltage current behaviors**

Symbol	Description	Min.	Typ.	Max.	Unit
$I_{DD\_PGM}$	Average current adder during high voltage flash programming operation	—	2.5	6.0	mA
$I_{DD\_ERS}$	Average current adder during high voltage flash erase operation	—	1.5	4.0	mA

### 6.3.1.4 Reliability specifications

**Table 26. NVM reliability specifications**

Symbol	Description	Min.	Typ. <sup>1</sup>	Max.	Unit	Notes
Program Flash						
$t_{nvmretp10k}$	Data retention after up to 10 K cycles	5	50	—	years	—
$t_{nvmretp1k}$	Data retention after up to 1 K cycles	20	100	—	years	—
$n_{nvmcycp}$	Cycling endurance	10 K	50 K	—	cycles	2

1. Typical data retention values are based on measured response accelerated at high temperature and derated to a constant 25 °C use profile. Engineering Bulletin EB618 does not apply to this technology. Typical endurance defined in Engineering Bulletin EB619.
2. Cycling endurance represents number of program/erase cycles at  $-40\text{ °C} \leq T_j \leq 125\text{ °C}$ .

## 6.4 Analog

## 6.4.1 ADC electrical specifications

All ADC channels meet the 12-bit single-ended accuracy specifications.

### 6.4.1.1 16-bit ADC operating conditions

Table 27. 16-bit ADC operating conditions

Symbol	Description	Conditions	Min.	Typ. <sup>1</sup>	Max.	Unit	Notes
$V_{DDA}$	Supply voltage	Absolute	1.71	—	3.6	V	—
$\Delta V_{DDA}$	Supply voltage	Delta to $V_{DD}$ ( $V_{DD} - V_{DDA}$ )	-100	0	+100	mV	2
$\Delta V_{SSA}$	Ground voltage	Delta to $V_{SS}$ ( $V_{SS} - V_{SSA}$ )	-100	0	+100	mV	2
$V_{REFH}$	ADC reference voltage high		1.13	$V_{DDA}$	$V_{DDA}$	V	
$V_{REFL}$	ADC reference voltage low		$V_{SSA}$	$V_{SSA}$	$V_{SSA}$	V	
$V_{ADIN}$	Input voltage		$V_{REFL}$	—	$V_{REFH}$	V	—
$C_{ADIN}$	Input capacitance	<ul style="list-style-type: none"> <li>16-bit mode</li> <li>8-bit / 10-bit / 12-bit modes</li> </ul>	—	8	10	pF	—
$R_{ADIN}$	Input series resistance		—	2	5	k $\Omega$	—
$R_{AS}$	Analog source resistance (external)	12-bit modes $f_{ADCK} < 4$ MHz	—	—	5	k $\Omega$	3
$f_{ADCK}$	ADC conversion clock frequency	$\leq$ 12-bit mode	1.0	—	18.0	MHz	4
$f_{ADCK}$	ADC conversion clock frequency	16-bit mode	2.0	—	12.0	MHz	4
$C_{rate}$	ADC conversion rate	$\leq$ 12-bit modes No ADC hardware averaging Continuous conversions enabled, subsequent conversion time	20.000	—	818.330	Ksps	5
$C_{rate}$	ADC conversion rate	16-bit mode No ADC hardware averaging Continuous conversions enabled, subsequent conversion time	37.037	—	461.467	Ksps	5

1. Typical values assume  $V_{DDA} = 3.0$  V, Temp = 25 °C,  $f_{ADCK} = 1.0$  MHz, unless otherwise stated. Typical values are for reference only, and are not tested in production.
2. DC potential difference.
3. This resistance is external to MCU. To achieve the best results, the analog source resistance must be kept as low as possible. The results in this data sheet were derived from a system that had  $< 8$   $\Omega$  analog source resistance. The  $R_{AS}/C_{AS}$  time constant should be kept to  $< 1$  ns.
4. To use the maximum ADC conversion clock frequency, CFG2[ADHSC] must be set and CFG1[ADLPC] must be clear.
5. For guidelines and examples of conversion rate calculation, download the [ADC calculator tool](#).

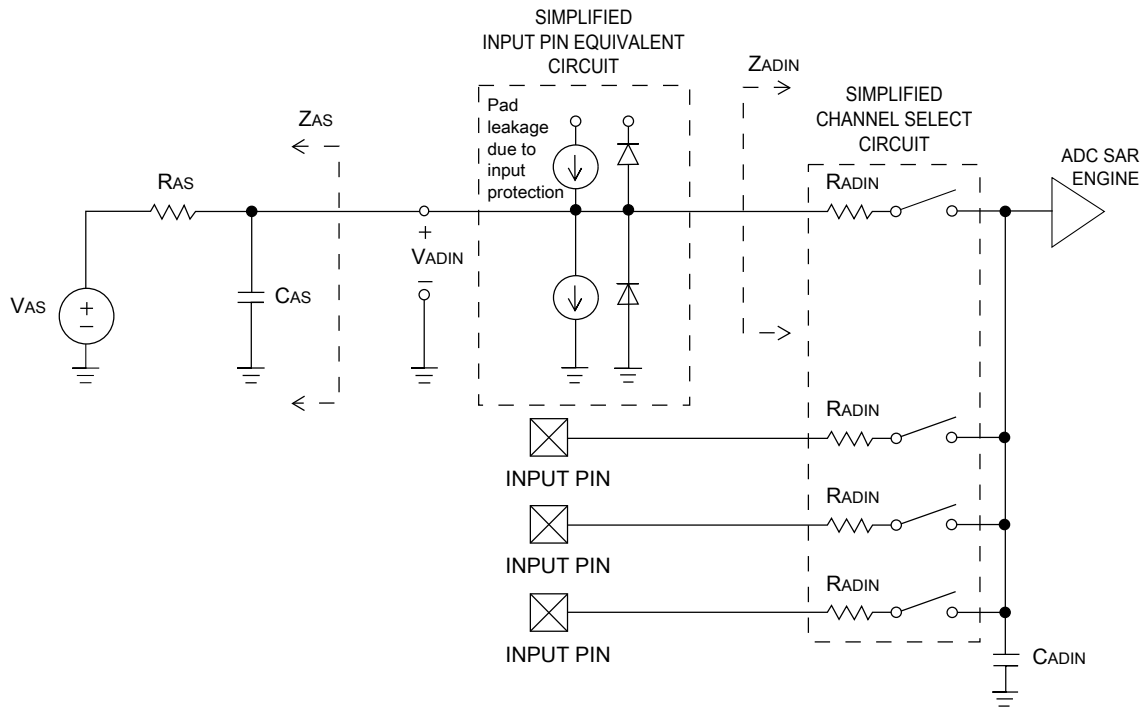

Figure 2. ADC input impedance equivalency diagram

### 6.4.1.2 16-bit ADC electrical characteristics

**Table 28. 16-bit ADC characteristics ( $V_{REFH} = V_{DDA}$ ,  $V_{REFL} = V_{SSA}$ )**

Symbol	Description	Conditions <sup>1</sup>	Min.	Typ. <sup>2</sup>	Max.	Unit	Notes
$I_{DDA\_ADC}$	Supply current		0.215	—	1.7	mA	3
$f_{ADACK}$	ADC asynchronous clock source	<ul style="list-style-type: none"> <li>ADLPC = 1, ADHSC = 0</li> <li>ADLPC = 1, ADHSC = 1</li> <li>ADLPC = 0, ADHSC = 0</li> <li>ADLPC = 0, ADHSC = 1</li> </ul>	1.2	2.4	3.9	MHz	$t_{ADACK} = 1/f_{ADACK}$
			2.4	4.0	6.1	MHz	
			3.0	5.2	7.3	MHz	
			4.4	6.2	9.5	MHz	
	Sample Time	See Reference Manual chapter for sample times					
TUE	Total unadjusted error	<ul style="list-style-type: none"> <li>12-bit modes</li> <li>&lt;12-bit modes</li> </ul>	—	±4	±6.8	LSB <sup>4</sup>	5
DNL	Differential non-linearity	<ul style="list-style-type: none"> <li>12-bit modes</li> <li>&lt;12-bit modes</li> </ul>	—	±0.7	-1.1 to +1.9	LSB <sup>4</sup>	5
INL	Integral non-linearity	<ul style="list-style-type: none"> <li>12-bit modes</li> <li>&lt;12-bit modes</li> </ul>	—	±1.0	-2.7 to +1.9	LSB <sup>4</sup>	5
				±0.5	-0.7 to +0.5		

Table continues on the next page...

**Table 28. 16-bit ADC characteristics ( $V_{REFH} = V_{DDA}$ ,  $V_{REFL} = V_{SSA}$ ) (continued)**

Symbol	Description	Conditions <sup>1</sup>	Min.	Typ. <sup>2</sup>	Max.	Unit	Notes
$E_{FS}$	Full-scale error	<ul style="list-style-type: none"> <li>12-bit modes</li> <li>&lt;12-bit modes</li> </ul>	—	-4	-5.4	LSB <sup>4</sup>	$V_{ADIN} = V_{DDA}$ <sup>5</sup>
$E_Q$	Quantization error	<ul style="list-style-type: none"> <li>16-bit modes</li> <li>12-bit modes</li> </ul>	—	-1 to 0	—	LSB <sup>4</sup>	
ENOB	Effective number of bits	16-bit single-ended mode	12.8	14.5	—	bits	6
			11.9	13.8	—	bits	
			12.2	13.9	—	bits	
			11.4	13.1	—	bits	
SINAD	Signal-to-noise plus distortion	See ENOB	6.02 × ENOB + 1.76			dB	
THD	Total harmonic distortion	16-bit single-ended mode	—	-94	—	dB	7
			—	-85	—	dB	
SFDR	Spurious free dynamic range	16-bit single-ended mode	82	95	—	dB	7
			78	90	—	dB	
$E_{IL}$	Input leakage error		$I_{in} \times R_{AS}$			mV	$I_{in}$ = leakage current (refer to the MCU's voltage and current operating ratings)
	Temp sensor slope	Across the full temperature range of the device	1.55	1.62	1.69	mV/°C	8
$V_{TEMP25}$	Temp sensor voltage	25 °C	706	716	726	mV	8

- All accuracy numbers assume the ADC is calibrated with  $V_{REFH} = V_{DDA}$
- Typical values assume  $V_{DDA} = 3.0$  V, Temp = 25 °C,  $f_{ADCK} = 2.0$  MHz unless otherwise stated. Typical values are for reference only and are not tested in production.
- The ADC supply current depends on the ADC conversion clock speed, conversion rate and ADC\_CFG1[ADLPC] (low power). For lowest power operation, ADC\_CFG1[ADLPC] must be set, the ADC\_CFG2[ADHSC] bit must be clear with 1 MHz ADC conversion clock speed.
- 1 LSB =  $(V_{REFH} - V_{REFL})/2^N$
- ADC conversion clock < 16 MHz, Max hardware averaging (AVGE = %1, AVGS = %11)
- Input data is 100 Hz sine wave. ADC conversion clock < 12 MHz.
- Input data is 1 kHz sine wave. ADC conversion clock < 12 MHz.
- ADC conversion clock < 3 MHz



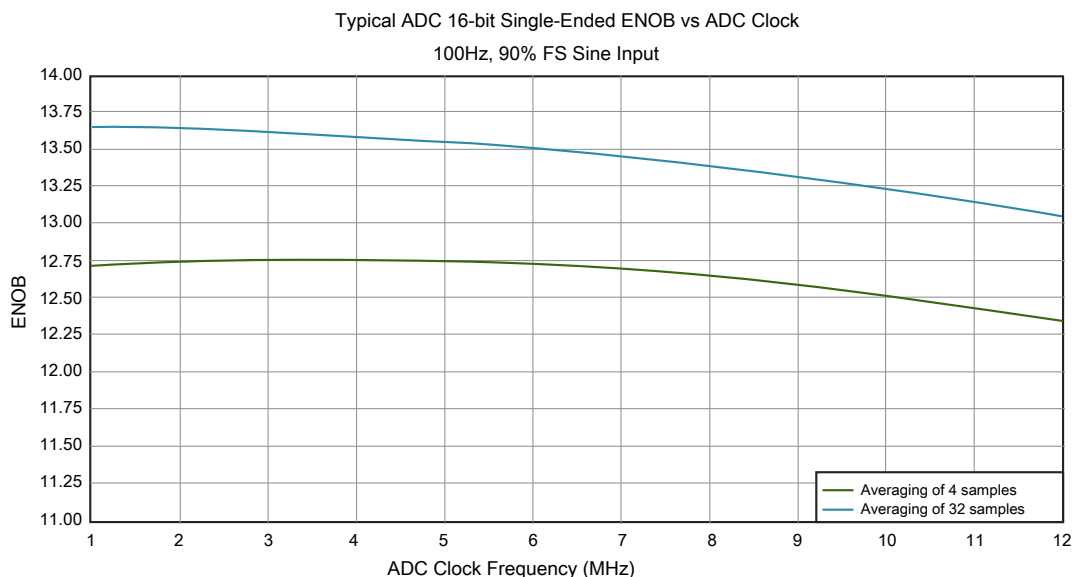

**Figure 3. Typical ENOB vs. ADC\_CLK for 16-bit single-ended mode**

## 6.4.2 CMP and 6-bit DAC electrical specifications

**Table 29. Comparator and 6-bit DAC electrical specifications**

Symbol	Description	Min.	Typ.	Max.	Unit
$V_{DD}$	Supply voltage	1.71	—	3.6	V
$I_{DDHS}$	Supply current, High-speed mode (EN=1, PMODE=1)	—	—	200	$\mu$ A
$I_{DDL S}$	Supply current, low-speed mode (EN=1, PMODE=0)	—	—	20	$\mu$ A
$V_{AIN}$	Analog input voltage	$V_{SS} - 0.3$	—	$V_{DD}$	V
$V_{AIO}$	Analog input offset voltage	—	—	20	mV
$V_H$	Analog comparator hysteresis <sup>1</sup>	—	5	—	mV
		—	10	—	mV
		—	20	—	mV
		—	30	—	mV
		—	—	—	mV
$V_{CMPOH}$	Output high	$V_{DD} - 0.5$	—	—	V
$V_{CMPOI}$	Output low	—	—	0.5	V
$t_{DHS}$	Propagation delay, high-speed mode (EN=1, PMODE=1)	20	50	200	ns
$t_{DLS}$	Propagation delay, low-speed mode (EN=1, PMODE=0)	80	250	600	ns
	Analog comparator initialization delay <sup>2</sup>	—	—	40	$\mu$ s
$I_{DAC6b}$	6-bit DAC current adder (enabled)	—	7	—	$\mu$ A
INL	6-bit DAC integral non-linearity	-0.5	—	0.5	LSB <sup>3</sup>
DNL	6-bit DAC differential non-linearity	-0.3	—	0.3	LSB

### Peripheral operating requirements and behaviors

1. Typical hysteresis is measured with input voltage range limited to 0.6 to  $V_{DD}-0.6$  V.
2. Comparator initialization delay is defined as the time between software writes to change control inputs (Writes to CMP\_DACCR[DACEN], CMP\_DACCR[VRSEL], CMP\_DACCR[VOSEL], CMP\_MUXCR[PSEL], and CMP\_MUXCR[MSEL]) and the comparator output settling to a stable level.
3.  $1 \text{ LSB} = V_{\text{reference}}/64$

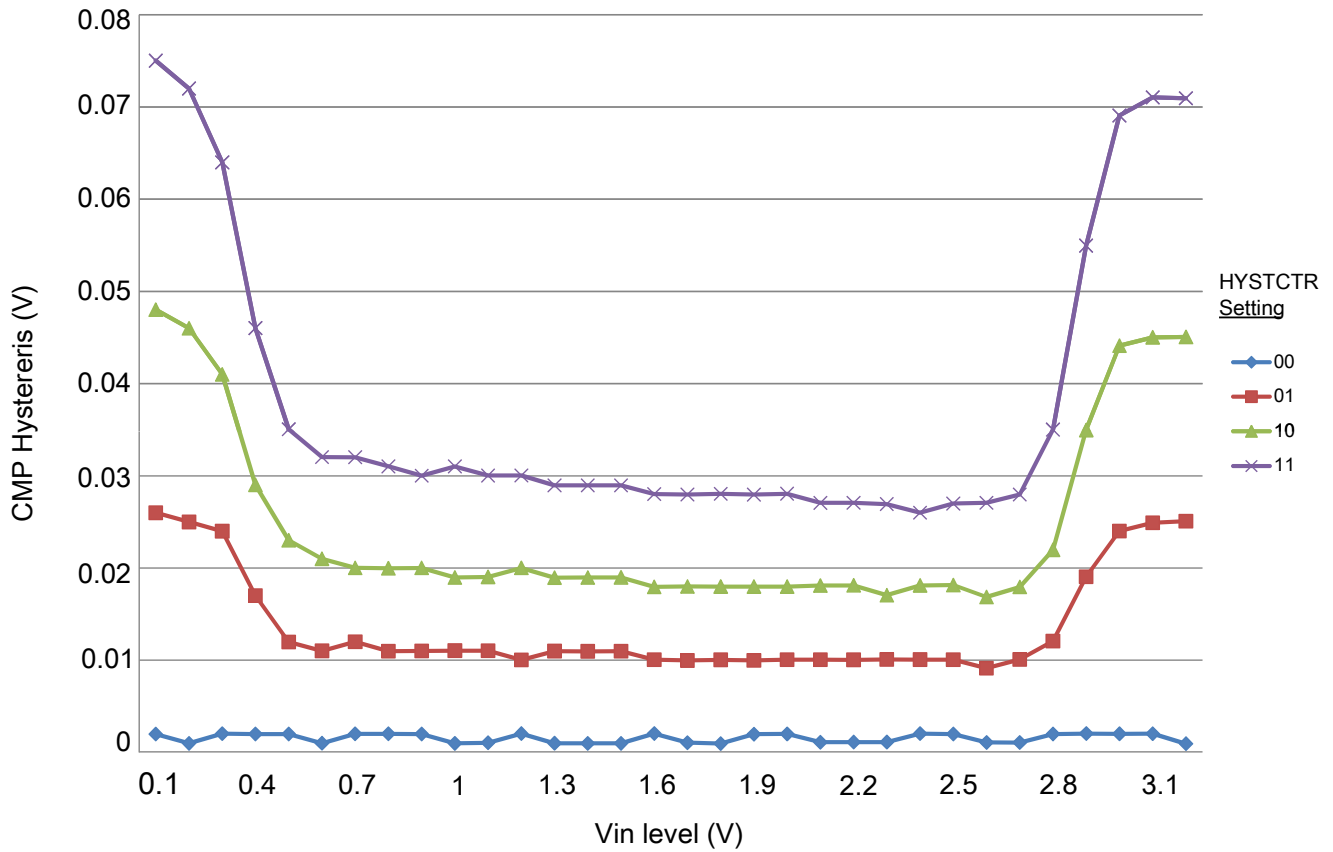

**Figure 4. Typical hysteresis vs. Vin level (VDD = 3.3 V, PMODE = 0)**

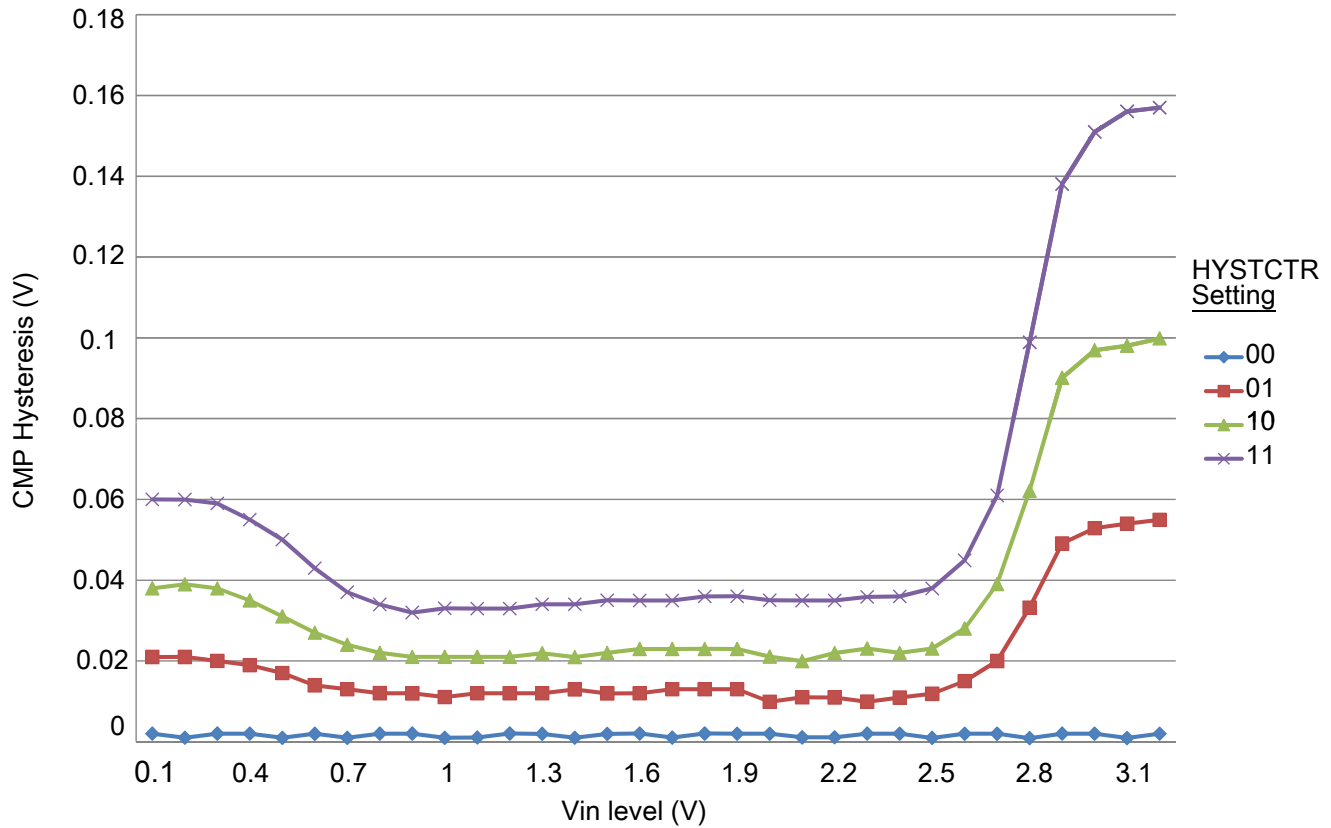

Figure 5. Typical hysteresis vs. Vin level (VDD = 3.3 V, PMODE = 1)

### 6.4.3 Voltage reference electrical specifications

Table 30. 1.2 VREF full-range operating requirements

Symbol	Description	Min.	Max.	Unit	Notes
V <sub>D</sub> DA	Supply voltage	1.71 <sup>1</sup>	3.6	V	
T <sub>A</sub>	Temperature	-40	85	°C	
C <sub>L</sub>	Output load capacitance	100		nF	2, 3

1. AFE is enabled.
2. C<sub>L</sub> must be connected between VREFH and VREFL.
3. The load capacitance should not exceed ±25% of the nominal specified C<sub>L</sub> value over the operating temperature range of the device.

Table 31. VREF full-range operating behaviors

Symbol	Description	Min.	Typ.	Max.	Unit	Notes
VREFH	Voltage reference output with factory trim at nominal V <sub>D</sub> DA and temperature = 25 °C	1.1915	1.195	1.2027	V	

Table continues on the next page...

**Table 31. VREF full-range operating behaviors (continued)**

Symbol	Description	Min.	Typ.	Max.	Unit	Notes
VREFH	Voltage reference output with — factory trim	1.1584	—	1.2376	V	
VREFH	Voltage reference output — user trim	1.178	—	1.202	V	
VREFL	Voltage reference output	0.38	0.4	0.42	V	
V <sub>step</sub>	Voltage reference trim step	—	0.5	—	mV	
V <sub>tdrift</sub>	Temperature drift when ICOMP = 0 across full temperature range	—	18	—	ppm/°C	
	Temperature drift when ICOMP = 1 across full temperature range	—	10	—	ppm/°C	1
	Temperature drift when ICOMP = 1 across -40 °C to 70 °C	—	9	—	ppm/°C	1, 2
	Temperature drift when ICOMP = 1 across 0 °C to 50 °C	—	9	—	ppm/°C	1, 2
Ac	Aging coefficient	—	—	400	uV/yr	
I <sub>bg</sub>	Bandgap only current	—	—	80	μA	2
I <sub>lp</sub>	Low-power buffer current	—	—	0.19	μA	2
I <sub>hp</sub>	High-power buffer current	—	—	0.5	mA	2
I <sub>LOAD</sub>	VREF buffer current	—	—	1	mA	3
ΔV <sub>LOAD</sub>	Load regulation <ul style="list-style-type: none"> <li>• current = + 1.0 mA</li> <li>• current = - 1.0 mA</li> </ul>	—	2 5	—	mV	2, 4
T <sub>stup</sub>	Buffer startup time	—	—	20	ms	
V <sub>vdrift</sub>	Voltage drift (VREFHmax -VREFHmin across the full voltage range)	—	0.5	—	mV	2

1. ICOMP=1 is recommended to get best temperature drift. CHOPEN bit = 1 is also recommended.
2. See the chip's Reference Manual for the appropriate settings of VREF Status and Control register.
3. See the chip's Reference Manual for the appropriate settings of SIM Miscellaneous Control Register.
4. Load regulation voltage is the difference between VREFH voltage with no load vs. voltage with defined load.

### NOTE

Temperature drift per degree is ( (VREFHmax-VREFHmin)/ (temperature range)/VREFHmin ) in ppm/°C

**Table 32. VREF limited-range operating requirements**

Symbol	Description	Min.	Max.	Unit	Notes
T <sub>A</sub>	Temperature	0	50	°C	

**Table 33. VREF limited-range operating behaviours**

Symbol	Description	Min.	Max.	Unit	Notes
VREFH	Voltage reference output with factory trim	1.173	1.225	V	
VREFL	Voltage reference output	0.38	0.42	V	

## 6.4.4 AFE electrical specifications

### 6.4.4.1 $\Sigma\Delta$ ADC + PGA specifications

**Table 34.  $\Sigma\Delta$  ADC + PGA specifications**

Symbol	Description	Conditions	Min	Typ <sup>1</sup>	Max	Unit	Notes
$f_{Nyq}$	Input bandwidth	Normal Mode	1.5	1.5	1.5	kHz	
		Low-Power Mode	1.5	1.5	1.5		
$V_{CM}$	Input Common Mode Reference		0		0.8	V	
$V_{IN_{diff}}$	Differential input range	Gain = 1 (PGA ON/OFF) <sup>2</sup>		+/- 500		mV	
		Gain = 2		+/- 250		mV	
		Gain = 4		+/- 125		mV	
		Gain = 8		+/- 62		mV	
		Gain = 16		+/- 31		mV	
		Gain = 32		+/- 15		mV	

Table continues on the next page...

**Table 34.  $\Sigma\Delta$  ADC + PGA specifications (continued)**

Symbol	Description	Conditions	Min	Typ <sup>1</sup>	Max	Unit	Notes
SNR	Signal to Noise Ratio	Normal Mode	90	92		dB	
		<ul style="list-style-type: none"> <li>• <math>f_{IN}=50\text{Hz}</math>; gain=01, common mode=0V, <math>V_{pp}=1000\text{mV}</math> (full range diff.)</li> <li>• <math>f_{IN}=50\text{Hz}</math>; gain=02, common mode=0V, <math>V_{pp}= 500\text{mV}</math> (differential ended )</li> <li>• <math>f_{IN}=50\text{Hz}</math>; gain=04, common mode=0V, <math>V_{pp}= 250\text{mV}</math> (differential ended )</li> <li>• <math>f_{IN}=50\text{Hz}</math>; gain=08, common mode=0V, <math>V_{pp}= 125\text{mV}</math> (differential ended )</li> <li>• <math>f_{IN}=50\text{Hz}</math>; gain=16, common mode=0V, <math>V_{pp}= 62\text{mV}</math> (differential ended )</li> <li>• <math>f_{IN}=50\text{Hz}</math>; gain=32, common mode=0V, <math>V_{pp}= 31\text{mV}</math> (differential ended )</li> </ul>	88	90			
		Low-Power Mode	82	82		dB	
		<ul style="list-style-type: none"> <li>• <math>f_{IN}=50\text{Hz}</math>; gain=01, common mode=0V, <math>V_{pp}=1000\text{mV}</math> (full range diff.)</li> <li>• <math>f_{IN}=50\text{Hz}</math>; gain=02, common mode=0V, <math>V_{pp}= 500\text{mV}</math> (differential ended )</li> <li>• <math>f_{IN}=50\text{Hz}</math>; gain=04, common mode=0V, <math>V_{pp}= 250\text{mV}</math> (differential ended )</li> <li>• <math>f_{IN}=50\text{Hz}</math>; gain=08, common mode=0V, <math>V_{pp}= 125\text{mV}</math> (differential ended )</li> <li>• <math>f_{IN}=50\text{Hz}</math>; gain=16, common mode=0V, <math>V_{pp}= 62\text{mV}</math> (differential ended )</li> <li>• <math>f_{IN}=50\text{Hz}</math>; gain=32, common mode=0V, <math>V_{pp}= 31\text{mV}</math> (differential ended )</li> </ul>	76	78			
SINAD	Signal-to-Noise + Distortion Ratio	Normal Mode		78		dB	
		<ul style="list-style-type: none"> <li>• <math>f_{IN}=50\text{Hz}</math>; gain=01, common mode=0V, <math>V_{pp}=500\text{mV}</math> (differential ended )</li> </ul>					
		Low-Power Mode		74		dB	
		<ul style="list-style-type: none"> <li>• <math>f_{IN}=50\text{Hz}</math>; gain=01, common mode=0V, <math>V_{pp}=500\text{mV}</math> (differential ended )</li> </ul>					
CMMR	Common Mode Rejection Ratio	<ul style="list-style-type: none"> <li>• <math>f_{IN}=50\text{Hz}</math>; gain=01, common mode=0V, <math>V_{id}=100\text{ mV}</math></li> <li>• <math>f_{IN}=50\text{Hz}</math>; gain=32, common mode=0V, <math>V_{id}=100\text{ mV}</math></li> </ul>		70		dB	
				70			

Table continues on the next page...

**Table 34.  $\Sigma\Delta$  ADC + PGA specifications (continued)**

Symbol	Description	Conditions	Min	Typ <sup>1</sup>	Max	Unit	Notes
$E_{\text{offset}}$	Offset Error	Gain=01, $V_{\text{pp}}=1000$ mV (full range diff.)			+/- 5	mV	
$\Delta\text{Offset}_{\text{Temp}}$	Offset Temperature Drift <sup>3</sup>	Gain=01, $V_{\text{pp}}=1000$ mV (full range diff.)			+/- 25	ppm/°C	
$\Delta\text{Gain}_{\text{Te}_{\text{mp}}}$	Gain Temperate Drift - Gain error caused by temperature drifts <sup>4</sup>	<ul style="list-style-type: none"> <li>Gain=01, <math>V_{\text{pp}}=500</math>mV (differential ended)</li> <li>Gain=32, <math>V_{\text{pp}}=15</math>mV (differential ended)</li> </ul>			+/- 75	ppm/°C	
$\text{PSRR}_{\text{AC}}$	AC Power Supply Rejection Ratio	Gain=01, $V_{\text{CC}} = 3\text{V} \pm 100$ mV, $f_{\text{IN}} = 50$ Hz		60		dB	
XT	Crosstalk (with the input of the affected channel grounded)	Gain=01, $V_{\text{id}} = 500$ mV, $f_{\text{IN}} = 50$ Hz			-100	dB	
$f_{\text{MCLK}}$	Modulator Clock Frequency Range	Normal Mode Low-Power Mode	0.03 0.03		6.5 1.6	MHz	
$I_{\text{DDA\_PGA}}$	Current consumption by PGA (each channel)	Normal Mode ( $f_{\text{MCLK}} = 6.144$ MHz, OSR= 2048) Low-Power Mode ( $f_{\text{MCLK}} = 0.768$ MHz, OSR= 256)			2.6 0	mA	5
$I_{\text{DDA\_ADC}}$	Current Consumption by ADC (each chanel)	Normal Mode ( $f_{\text{MCLK}} = 6.144$ MHz, OSR= 2048) Low-Power Mode ( $f_{\text{MCLK}} = 0.768$ MHz, OSR= 256)			1.4 0.5	mA	
$R_{\text{as}}$	Equivalent input impedance per single channel	PGA enabled		8		k $\Omega$	

1. Typical values assume  $V_{\text{DDA}} = 3.0$  V, Temp = 25°C,  $f_{\text{MCLK}} = 6.144$  MHz, OSR = 2048 for Normal mode and  $f_{\text{MCLK}} = 768$  kHz, OSR = 256 for Low-Power Mode unless otherwise stated. Typical values are for reference only and are not tested in production.
2. The full-scale input range in single-ended mode is 0.5Vpp
3. Represents combined offset temperature drift of the PGA, SD ADC and Internal 1.2 VREF blocks; Defined by shorting both differential inputs to ground.
4. Represents combined gain temperature drift of the PGA, SD ADC and Internal 1.2 VREF blocks.
5. PGA is disabled in low-power modes.

### 6.4.4.2 $\Sigma\Delta$ ADC Standalone specifications

**Table 35.  $\Sigma\Delta$  ADC standalone specifications**

Symbol	Description	Conditions	Min	Typ <sup>1</sup>	Max	Unit	Notes
$f_{\text{Nyq}}$	Input bandwidth	Normal Mode Low-Power Mode	1.5 1.5	1.5 1.5	1.5 1.5	kHz	
$V_{\text{CM}}$	Input Common Mode Reference		0		0.8	V	

Table continues on the next page...

**Table 35.  $\Sigma\Delta$  ADC standalone specifications (continued)**

Symbol	Description	Conditions	Min	Typ <sup>1</sup>	Max	Unit	Notes
VIN <sub>diff</sub>	Input range	Differential		+/- 500		mV	
		Single Ended		+/- 250		mV	
SNR	Signal to Noise Ratio	Normal Mode				dB	
		<ul style="list-style-type: none"> <li>f<sub>IN</sub>=50Hz; common mode=0V, V<sub>pp</sub>= 500mV (differential ended)</li> <li>f<sub>IN</sub>=50Hz; common mode=0V, V<sub>pp</sub>= 500mV (full range se.)</li> </ul>	88	90			
		Low-Power Mode <ul style="list-style-type: none"> <li>f<sub>IN</sub>=50Hz; common mode=0V, V<sub>pp</sub>=500mV (diff.)</li> <li>f<sub>IN</sub>=50Hz; common mode=0V, V<sub>pp</sub>=500mV (full range se.)</li> </ul>	76	78			
$\Delta$ Gain <sub>Temp</sub> <sub>mp</sub>	Gain Temperate Drift - Gain error caused by temperature drifts <sup>2</sup>	<ul style="list-style-type: none"> <li>Gain bypassed V<sub>pp</sub> = 500 mV (differential)</li> <li>PGA bypassed V<sub>pp</sub> = 500 mV (differential), VCM = 0 V</li> </ul>			55	ppm/°C	
$\Delta$ Offset <sub>Temp</sub>	Offset Temperate Drift - Offset error caused by temperature drifts <sup>3</sup>	<ul style="list-style-type: none"> <li>Gain bypassed V<sub>pp</sub> = 500 mV (differential), VCM = 0 V</li> </ul>			30	ppm/°C	
SINAD	Signal-to-Noise + Distortion Ratio	Normal Mode				dB	
		<ul style="list-style-type: none"> <li>f<sub>IN</sub>=50Hz; common mode=0V, V<sub>pp</sub>= 500mV (diff.)</li> <li>f<sub>IN</sub>=50Hz; common mode=0V, V<sub>pp</sub>= 500mV (full range se.)</li> </ul> Low-Power Mode <ul style="list-style-type: none"> <li>f<sub>IN</sub>=50Hz; common mode=0V, V<sub>pp</sub>=500mV (diff.)</li> <li>f<sub>IN</sub>=50Hz; common mode=0V, V<sub>pp</sub>=500mV (full range se.)</li> </ul>		80	74		
CMMR	Common Mode Rejection Ratio	<ul style="list-style-type: none"> <li>f<sub>IN</sub>=50Hz; common mode=0V, V<sub>id</sub>=100 mV</li> </ul>		90		dB	
PSRR <sub>A</sub> <sub>C</sub>	AC Power Supply Rejection Ratio	Gain=01, VCC = 3V ± 100mV, f <sub>IN</sub> = 50 Hz		60		dB	
XT	Crosstalk	Gain=01, V <sub>id</sub> = 500 mV, f <sub>IN</sub> = 50 Hz			-100	dB	
f <sub>MCLK</sub>	Modulator Clock Frequency Range	Normal Mode	0.03		6.5	MHz	
		Low-Power Mode	0.03		1.6		
I <sub>DDA_AD</sub> <sub>C</sub>	Current Consumption by ADC (each channel)	Normal Mode (f <sub>MCLK</sub> = 6.144 MHz, OSR= 2048)			1.4	mA	
		Low-Power Mode (f <sub>MCLK</sub> = 0.768MHz, OSR= 256)			0.5		
R <sub>as</sub>	Equivalent input impedance at normal operating mode (6.144 MHz)	PGA disabled		73		kΩ	



1. Typical values assume  $V_{DDA} = 3.0\text{ V}$ ,  $\text{Temp} = 25^\circ\text{C}$ ,  $f_{\text{MCLK}} = 6.144\text{ MHz}$ ,  $\text{OSR} = 2048$  for Normal mode and  $f_{\text{MCLK}} = 768\text{ kHz}$ ,  $\text{OSR} = 256$  for Low-Power Mode unless otherwise stated. Typical values are for reference only and are not tested in production.
2. Represent combined gain temperature drift of the SD ADC, and Internal 1.2 VREF blocks.
3. Represent combined offset temperature drift of the SD ADC, and Internal 1.2 VREF blocks; Defined by shorting both differential inputs to ground.

#### 6.4.4.3 External modulator interface

The external modulator interface on this device comprises of a Clock signal and 1-bit data signal. Depending on the modulator device being used the interface works as follows:

- Clock supplied to external modulator which drives data on rising edge and the KM device captures it on falling edge or next rising edge.
- Clock and data are supplied by external modulator and KM device can sample it on falling edge or next rising edge.

Depending on control bit in AFE, the sampling edge is changed.

## 6.5 Timers

See [General switching specifications](#).

## 6.6 Communication interfaces

### 6.6.1 I2C switching specifications

See [General switching specifications](#).

### 6.6.2 UART switching specifications

See [General switching specifications](#).

### 6.6.3 SPI switching specifications

The Serial Peripheral Interface (SPI) provides a synchronous serial bus with master and slave operations. Many of the transfer attributes are programmable. The following table provides some reference values to be met on SoC.

**Table 36. SPI switching characteristics at 2.7 V ( 2.7 - 3.6)**

Description	Min.	Max.	Unit	Notes
Frequency of operation ( $F_{sys}$ )	—	50	MHz	1
SCK frequency <ul style="list-style-type: none"> <li>• Master</li> <li>• Slave</li> </ul>	2	12.5 12.5	MHz Mhz	3
SCK Duty Cycle	50%	—	—	
Data Setup Time (inputs, tSUI) <ul style="list-style-type: none"> <li>• Master</li> <li>• Slave</li> </ul>	25 3		ns	
Input Data Hold Time (inputs, tHI) <ul style="list-style-type: none"> <li>• Master</li> <li>• Slave</li> </ul>	0 1		ns	
Data hold time (outputs, tHO) <ul style="list-style-type: none"> <li>• Master</li> <li>• Slave</li> </ul>	0 0		ns	
Data Valid Out Time (after SCK edge, tDVO) <ul style="list-style-type: none"> <li>• Master</li> <li>• Slave</li> </ul>	13 28		ns	
Rise time input <ul style="list-style-type: none"> <li>• Master</li> <li>• Slave</li> </ul>	1 1		ns	
Fall time input <ul style="list-style-type: none"> <li>• Master</li> <li>• Slave</li> </ul>	1 1		ns	
Rise time output <ul style="list-style-type: none"> <li>• Master</li> <li>• Slave</li> </ul>	8.9 8.9		ns	
Fall time output <ul style="list-style-type: none"> <li>• Master</li> <li>• Slave</li> </ul>	7.8 7.8		ns	

1. SPI modules will work on core clock.
2.  $F_{sys}/(\text{Max Divider Value from registers})$
3.  $F_{SYS}/2$  in Master mode and  $F_{SYS}/4$  in Slave mode.  $F_{SYS}/4$  in Master as well as Slave Modes, where  $F_{SYS}=50\text{Mhz}$

**NOTE**

The values assumed for input transition and output load are:  
 Input transition = 1 ns Output load = 50 pF

**Table 37. SPI switching characteristics at 1.7 V ( 1.7 - 3.6)**

Description	Min.	Max.	Unit	Notes
Frequency of operation ( $F_{sys}$ )	—	50	MHz	

Table continues on the next page...

**Table 37. SPI switching characteristics at 1.7 V ( 1.7 - 3.6) (continued)**

Description	Min.	Max.	Unit	Notes
SCK frequency		9	MHz	
• Master		9	Mhz	
• Slave				
SCK Duty Cycle	50%	—	—	
Data Setup Time (inputs, tSUI)	42		ns	
• Master	3.5			
• Slave				
Input Data Hold Time (inputs, tHI)	0		ns	
• Master	1			
• Slave				
Data hold time (outputs, tHO)	-3		ns	
• Master	0			
• Slave				
Data Valid Out Time (tDVO)	16		ns	1
• Master	44			
• Slave				
Rise time input	1		ns	
• Master	1			
• Slave				
Fall time input	1		ns	
• Master	1			
• Slave				
Rise time output	14.4		ns	
• Master	14.4			
• Slave				
Fall time output	12.4		ns	
• Master	12.4			
• Slave				

1. SCK frequency of 9 Mhz is applicable only in the case that the input setup time of the device outside is not more than 11.5 ns, else the frequency would need to be lowered.

The following table represents SPI Switching specification in OD cells

**Table 38. SPI switching characteristics at 1.7 V ( 1.7 - 3.6)**

Description	Min.	Max.	Unit	Notes
Data Setup Time (inputs, tSUI)	51		ns	
• Master	4			
• Slave				
Input Data Hold Time (inputs, tHI)	0		ns	
• Master	1			
• Slave				
Data hold time (outputs, tHO)	-15		ns	
• Master	0			
• Slave				
Data Valid Out Time (tDVO)	61		ns	
• Master	93			
• Slave				

Table continues on the next page...

**Table 38. SPI switching characteristics at 1.7 V ( 1.7 - 3.6) (continued)**

Description	Min.	Max.	Unit	Notes
Rise time input • Master • Slave	1 1		ns	
Fall time input • Master • Slave	1 1		ns	
Rise time output • Master • Slave	30.4 30.4		ns	
Fall time output • Master • Slave	33.5 29.0		ns	

**Table 39. SPI switching characteristics at 2.7 V ( 2.7 - 3.6)**

Description	Min.	Max.	Unit	Notes
Data Setup Time (inputs, tSUI) • Master • Slave	29 4		ns	
Input Data Hold Time (inputs, tHI) • Master • Slave	0 1		ns	
Data hold time (outputs, tHO) • Master • Slave	0 0		ns	
Data Valid Out Time (after SCK edge, tDVO) • Master • Slave	49 49		ns	
Rise time input • Master • Slave	1 1		ns	
Fall time input • Master • Slave	1 1		ns	
Rise time output • Master • Slave	17.3 17.3		ns	
Fall time output • Master • Slave	16.6 16.0		ns	

## 6.7 Human-Machine Interfaces (HMI)

## 6.7.1 LCD electrical characteristics

Table 40. LCD electricals

Symbol	Description	Min.	Typ.	Max.	Unit	Notes
$f_{\text{Frame}}$	LCD frame frequency	28	30	58	Hz	
$C_{\text{LCD}}$	LCD charge pump capacitance — nominal value	—	100	—	nF	1
$C_{\text{BYLCD}}$	LCD bypass capacitance — nominal value	—	100	—	nF	1
$C_{\text{Glass}}$	LCD glass capacitance	—	2000	8000	pF	2
$V_{\text{IREG}}$	$V_{\text{IREG}}$ <ul style="list-style-type: none"> <li>HREFSEL=0, RVTRIM=1111</li> <li>HREFSEL=0, RVTRIM=1000</li> <li>HREFSEL=0, RVTRIM=0000</li> </ul>	—	1.11	—	V	3
$\Delta_{\text{RTRIM}}$	$V_{\text{IREG}}$ TRIM resolution	—	—	3.0	% $V_{\text{IREG}}$	
$I_{\text{VIREG}}$	$V_{\text{IREG}}$ current adder — RVEN = 1	—	1	—	$\mu\text{A}$	4
$I_{\text{RBIAS}}$	RBIAS current adder <ul style="list-style-type: none"> <li>LADJ = 10 or 11 — High load (LCD glass capacitance <math>\leq 8000</math> pF)</li> <li>LADJ = 00 or 01 — Low load (LCD glass capacitance <math>\leq 2000</math> pF)</li> </ul>	—	15	—	$\mu\text{A}$	
		—	3	—	$\mu\text{A}$	
VLL2	VLL2 voltage <ul style="list-style-type: none"> <li>HREFSEL = 0</li> </ul>	2.0 – 5%	2.0	—	V	
VLL3	VLL3 voltage	3.0 – 5%	3.0	—	V	

1. The actual value used could vary with tolerance.
2. For highest glass capacitance values, LCD\_GCR[LADJ] should be configured as specified in the LCD Controller chapter within the device's reference manual.
3.  $V_{\text{IREG}}$  maximum should never be externally driven to any level other than  $V_{\text{DD}} - 0.15$  V.
4. 2000 pF load LCD, 32 Hz frame frequency.

### NOTE

KM family devices have a 1/3 bias controller that works with a 1/3 bias LCD glass. To avoid ghosting, the LCD OFF threshold should be greater than VLL1 level. If the LCD glass has an OFF threshold less than VLL1 level, use the internal VREG mode and generate VLL1 internally using RVTRIM option. This can reduce VLL1 level to allow for a lower OFF threshold LCD glass.

## 7 Dimensions

## 7.1 Obtaining package dimensions

Package dimensions are provided in package drawings.

To find a package drawing, go to [freescale.com](http://freescale.com) and perform a keyword search for the drawing's document number:

If you want the drawing for this package	Then use this document number
44-pin LGA	98ASA00239D
64-pin LQFP	98ASS23234W
100-pin LQFP	98ASS23308W

## 8 Pinout

### NOTE

VSS also connects to flag on 44 LGA.

### 8.1 Package Types

KM family of devices shall support the following packages options:

- 100-pin LQFP (14 x 14 mm<sup>2</sup>)
- 64-pin LQFP (10 x 10 mm<sup>2</sup>)
- 44-pin LGA (5 x 5 mm<sup>2</sup>)

### NOTE

Pin muxing selection between TAMPER0 and WKUP is done using control bit in RTC registers.

### NOTE

All pin muxing configurations reset to default value on any reset assertion (reset asserts on VLLSx mode exit).

When RESET pin is used as GPIO and pulled low; an internal reset (e.g. VLLSx mode exit or WDOG reset, etc) will make this pin function as RESET (default function) and since it is pulled low, it will appear as if pin reset is asserted and will cause full chip reset.

## NOTE

- For devices other than MKMx4, the SDADP3 and SDADM3 functions on the corresponding pins are disabled.
- All input pins including TAMPER pins must be pulled up or down to avoid extra power consumption.

## 8.2 KM Signal Multiplexing and Pin Assignments

100 QFP	64 QFP	44 LGA	DEFAULT	ALTO	ALT1	ALT2	ALT3	ALT4	ALT5	ALT6	ALT7
1	1	—	Disabled	LCD23	PTA0						
2	2	—	Disabled	LCD24	PTA1						
3	3	—	Disabled	LCD25	PTA2						
4	—	—	Disabled	LCD26	PTA3						
5	4	1	NMI_B	LCD27	PTA4	LLWU_P15					NMI_B
6	5	2	Disabled	LCD28	PTA5	CMPOOUT					
7	6	3	Disabled	LCD29	PTA6	PXBAR_IN0	LLWU_P14				
8	7	4	Disabled	LCD30	PTA7	PXBAR_OUT0					
9	—	—	Disabled	LCD31	PTB0						
10	8	5	VDD	VDD							
11	9	6	VSS	VSS							
12	—	—	Disabled	LCD32	PTB1						
13	—	—	Disabled	LCD33	PTB2						
14	—	—	Disabled	LCD34	PTB3						
15	—	—	Disabled	LCD35	PTB4						
16	—	—	Disabled	LCD36	PTB5						
17	—	—	Disabled	LCD37/ CMP1P0	PTB6						
18	10	—	Disabled	LCD38	PTB7	AFE_CLK					
19	11	—	Disabled	LCD39	PTC0	SCI3_RTS	PXBAR_IN1				
20	12	—	Disabled	LCD40/ CMP1P1	PTC1	SCI3_CTS					
21	13	—	Disabled	LCD41	PTC2	SCI3_TxD	PXBAR_OUT1				
22	14	—	Disabled	LCD42/ CMP0P3	PTC3	SCI3_RxD	LLWU_P13				
23	—	—	Disabled	LCD43	PTC4						
24	15	7	VBAT	VBAT							
25	16	8	XTAL32K	XTAL32K							
26	17	9	EXTAL32K	EXTAL32K							
27	18	10	VSS	VSS							
28	18	10	TAMPER2	TAMPER2							
29	18	10	TAMPER1	TAMPER1							
30	19	11	WKUP	TAMPER0							

**Pinout**

100 QFP	64 QFP	44 LGA	DEFAULT	ALT0	ALT1	ALT2	ALT3	ALT4	ALT5	ALT6	ALT7
31	20	12	VDDA	VDDA							
32	21	13	VSSA	VSSA							
33	22	14	SDADP0	SDADP0							
34	23	15	SDADM0	SDADM0							
35	24	16	SDADP1	SDADP1							
36	25	17	SDADM1	SDADM1							
37	26	18	VREFH	VREFH							
38	27	19	VREFL	VREFL							
39	28	20	SDADP2/ CMP1P2	SDADP2/ CMP1P2							
40	29	21	SDADM2/ CMP1P3	SDADM2/ CMP1P3							
41	30	22	VREF	VREF							
42	—	24	SDADP3/ CMP1P4	SDADP3/ CMP1P4							
43	—	23	SDADM3/ CMP1P5	SDADM3/ CMP1P5							
44	—	—	Disabled	AD0	PTC5	SCI0_RTS	LLWU_P12				
45	—	—	Disabled	AD1	PTC6	SCI0_CTS	QT1				
46	—	—	Disabled	AD2	PTC7	SCI0_TxD	PXBAR_OUT2				
47	—	—	Disabled	CMP0P0	PTD0	SCI0_RxD	PXBAR_IN2	LLWU_P11			
48	31	—	Disabled		PTD1	SCI1_TxD	SPI0_SS_B	PXBAR_OUT3	QT3		
49	32	—	Disabled	CMP0P1	PTD2	SCI1_RxD	SPI0_SCK	PXBAR_IN3	LLWU_P10		
50	33	—	Disabled		PTD3	SCI1_CTS	SPI0_MOSI				
51	34	—	Disabled	AD3	PTD4	SCI1_RTS	SPI0_MISO	LLWU_P9			
52	—	—	Disabled	AD4	PTD5	LPTIM2	QT0	SCI3_CTS			
53	—	—	Disabled	AD5	PTD6	LPTIM1	CMP1OUT	SCI3_RTS	LLWU_P8		
54	—	—	Disabled	CMP0P4	PTD7	I2C0_SCL	PXBAR_IN4	SCI3_RxD	LLWU_P7		
55	—	—	Disabled		PTE0	I2C0_SDA	PXBAR_OUT4	SCI3_TxD	CLKOUT		
56	35	25	RESET_B		PTE1						RESET_B
57	—	26	EXTAL1	EXTAL1	PTE2	EWM_IN	PXBAR_IN6	I2C1_SDA			
58	—	27	XTAL1	XTAL1	PTE3	EWM_OUT	AFE_CLK	I2C1_SCL			
59	36	28	VSS	VSS							
60	36	29	SAR_VSSA	SAR_VSSA							
61	37	30	SAR_VDDA	SAR_VDDA							
62	37	31	VDD	VDD							
63	—	—	Disabled		PTE4	LPTIM0	SCI2_CTS	EWM_IN			
64	—	—	Disabled		PTE5	QT3	SCI2_RTS	EWM_OUT	LLWU_P6		
65	38	32	SWD_IO	CMP0P2	PTE6	PXBAR_IN5	SCI2_RxD	LLWU_P5	I2C0_SCL		SWD_IO
66	39	33	SWD_CLK	AD6	PTE7	PXBAR_OUT5	SCI2_TxD		I2C0_SDA		SWD_CLK
67	40	—	Disabled	AD7	PTF0	RTCCLKOUT	QT2	CMP0OUT	LLWU_P4		



100 QFP	64 QFP	44 LGA	DEFAULT	ALT0	ALT1	ALT2	ALT3	ALT4	ALT5	ALT6	ALT7
68	41	34	Disabled	LCD0/ AD8	PTF1	QT0	PXBAR_OUT6				
69	42	35	Disabled	LCD1/ AD9	PTF2	CMP1OUT	RTCCLKOUT				
70	43	—	Disabled	LCD2	PTF3	SPI1_SS_B	LPTIM1	SCI0_RxD			
71	44	—	Disabled	LCD3	PTF4	SPI1_SCK	LPTIM0	SCI0_TxD			
72	45	—	Disabled	LCD4	PTF5	SPI1_MISO	I2C1_SCL				
73	46	—	Disabled	LCD5	PTF6	SPI1_MOSI	I2C1_SDA	LLWU_P3			
74	47	—	Disabled	LCD6	PTF7	QT2	CLKOUT				
75	48	—	Disabled	LCD7	PTG0	QT1	LPTIM2				
76	49	36	Disabled	LCD8/ AD10	PTG1	LLWU_P2	LPTIM0				
77	50	37	Disabled	LCD9/ AD11	PTG2	SPI0_SS_B	LLWU_P1				
78	51	38	Disabled	LCD10	PTG3	SPI0_SCK	I2C0_SCL				
79	52	39	Disabled	LCD11	PTG4	SPI0_MOSI	I2C0_SDA				
80	53	40	Disabled	LCD12	PTG5	SPI0_MISO	LPTIM1				
81	54	—	Disabled	LCD13	PTG6	LLWU_P0	LPTIM2				
82	—	—	Disabled	LCD14	PTG7						
83	—	—	Disabled	LCD15	PTH0						
84	—	—	Disabled	LCD16	PTH1						
85	—	—	Disabled	LCD17	PTH2						
86	—	—	Disabled	LCD18	PTH3						
87	—	—	Disabled	LCD19	PTH4						
88	—	—	Disabled	LCD20	PTH5						
89	—	41	Disabled		PTH6	SCI1_CTS	SPI1_SS_B	PXBAR_IN7			
90	—	42	Disabled		PTH7	SCI1_RTS	SPI1_SCK	PXBAR_OUT7			
91	55	43	Disabled	CMP0P5	PTI0	SCI1_RxD	PXBAR_IN8	SPI1_MISO	SPI1_MOSI		
92	56	44	Disabled		PTI1	SCI1_TxD	PXBAR_OUT8	SPI1_MOSI	SPI1_MISO		
93	57	—	Disabled	LCD21	PTI2						
94	58	—	Disabled	LCD22	PTI3						
95	59	—	VSS	VSS							
96	60	—	VLL3	VLL3							
97	61	—	VLL2	VLL2							
98	62	—	VLL1	VLL1							
99	63	—	VCAP2	VCAP2							
100	64	—	VCAP1	VCAP1							

## 8.3 KM Family Pinouts



### 8.3.2 64-pin LQFP

Figure below shows the 64-pin LQFP pinouts.

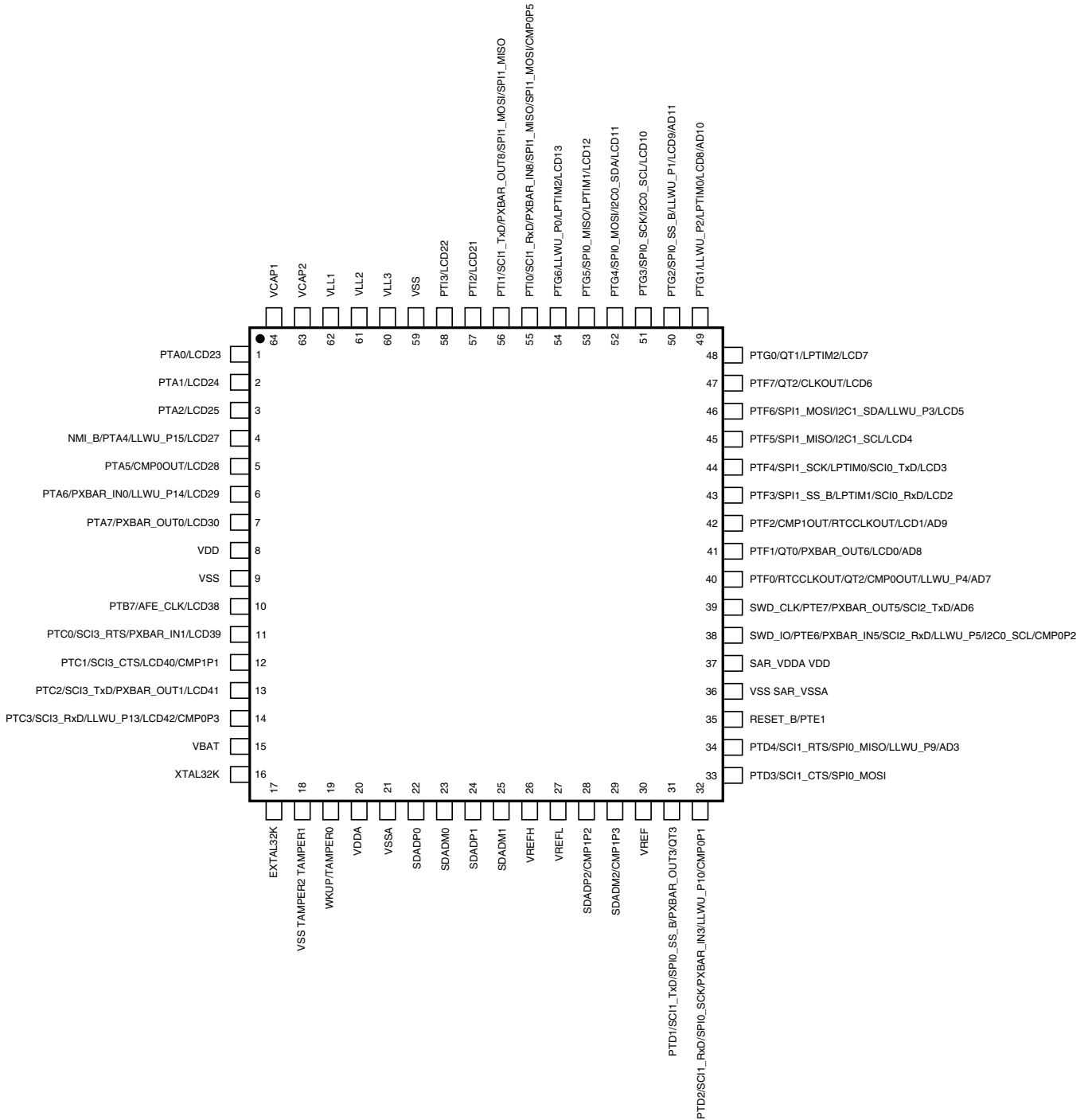

Figure 7. 64-pin LQFP Pinout Diagram

### 8.3.3 44-pin LGA

Figure below shows the 44-pin LGA pinouts.

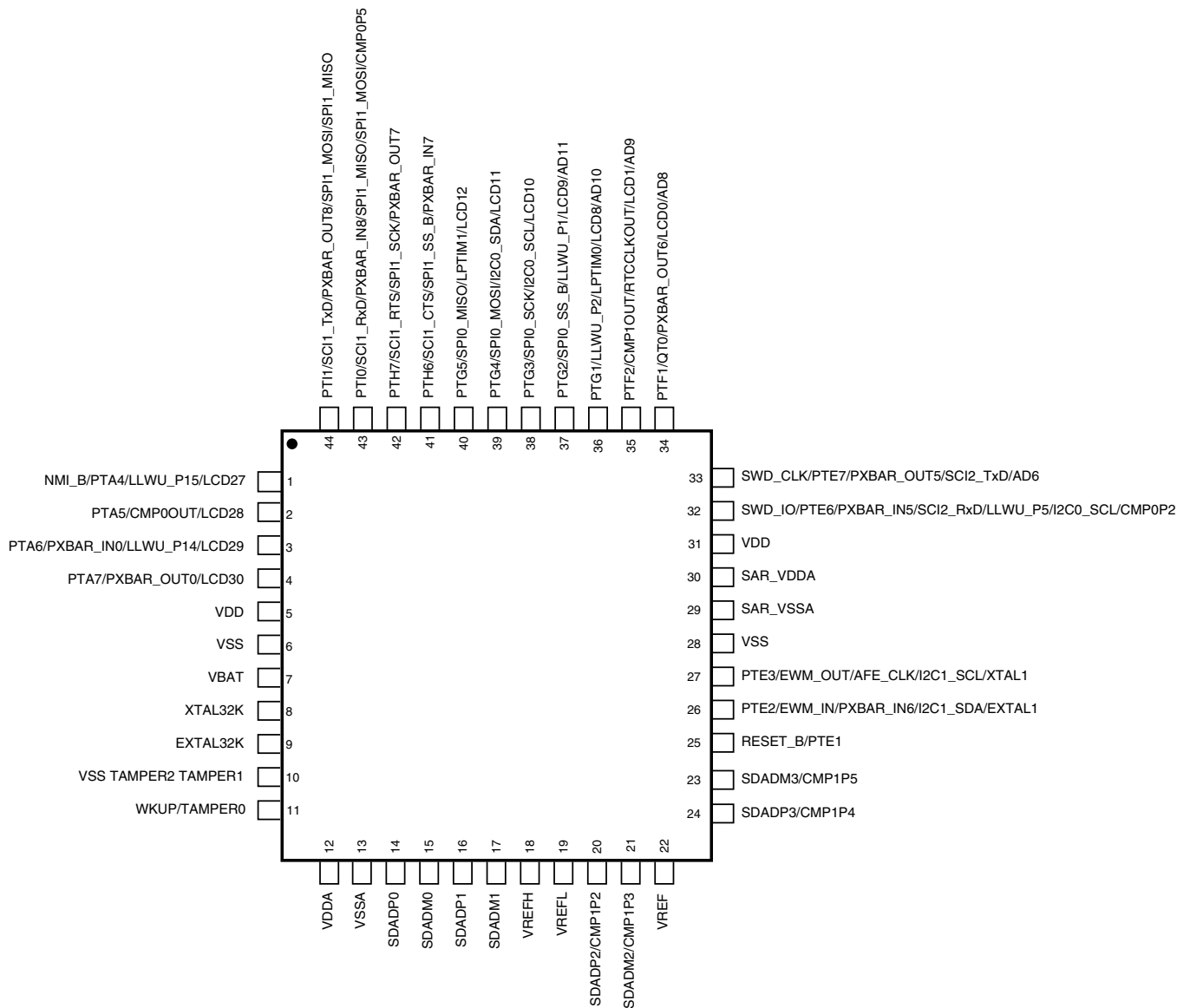

Figure 8. 44-pin LGA Pinout Diagram

**NOTE**

VSS also connects to flag on 44 LGA.

**How to Reach Us:**

**Home Page:**

[freescale.com](http://freescale.com)

**Web Support:**

[freescale.com/support](http://freescale.com/support)

Information in this document is provided solely to enable system and software implementers to use Freescale products. There are no express or implied copyright licenses granted hereunder to design or fabricate any integrated circuits based on the information in this document. Freescale reserves the right to make changes without further notice to any products herein.

Freescale makes no warranty, representation, or guarantee regarding the suitability of its products for any particular purpose, nor does Freescale assume any liability arising out of the application or use of any product or circuit, and specifically disclaims any and all liability, including without limitation consequential or incidental damages. "Typical" parameters that may be provided in Freescale data sheets and/or specifications can and do vary in different applications, and actual performance may vary over time. All operating parameters, including "typicals," must be validated for each customer application by customer's technical experts. Freescale does not convey any license under its patent rights nor the rights of others. Freescale sells products pursuant to standard terms and conditions of sale, which can be found at the following address: [www.freescale.com/salestermsandconditions](http://www.freescale.com/salestermsandconditions).

Freescale, the Freescale logo, and Kinetis are trademarks of Freescale Semiconductor, Inc., Reg. U.S. Pat. & Tm. Off. All other product or service names are the property of their respective owners. ARM and Cortex are registered trademarks of ARM Limited (or its subsidiaries) in the EU and/or elsewhere. All rights reserved.

©2014 Freescale Semiconductor, Inc.



Компания «ЭлектроПласт» предлагает заключение долгосрочных отношений при поставках импортных электронных компонентов на взаимовыгодных условиях!

Наши преимущества:

- Оперативные поставки широкого спектра электронных компонентов отечественного и импортного производства напрямую от производителей и с крупнейших мировых складов;
- Поставка более 17-ти миллионов наименований электронных компонентов;
- Поставка сложных, дефицитных, либо снятых с производства позиций;
- Оперативные сроки поставки под заказ (от 5 рабочих дней);
- Экспресс доставка в любую точку России;
- Техническая поддержка проекта, помощь в подборе аналогов, поставка прототипов;
- Система менеджмента качества сертифицирована по Международному стандарту ISO 9001;
- Лицензия ФСБ на осуществление работ с использованием сведений, составляющих государственную тайну;
- Поставка специализированных компонентов (Xilinx, Altera, Analog Devices, Intersil, Interpoint, Microsemi, Aeroflex, Peregrine, Syfer, Eurofarad, Texas Instrument, Miteq, Cobham, E2V, MA-COM, Hittite, Mini-Circuits, General Dynamics и др.);

Помимо этого, одним из направлений компании «ЭлектроПласт» является направление «Источники питания». Мы предлагаем Вам помощь Конструкторского отдела:

- Подбор оптимального решения, техническое обоснование при выборе компонента;
- Подбор аналогов;
- Консультации по применению компонента;
- Поставка образцов и прототипов;
- Техническая поддержка проекта;
- Защита от снятия компонента с производства.



#### Как с нами связаться

**Телефон:** 8 (812) 309 58 32 (многоканальный)

**Факс:** 8 (812) 320-02-42

**Электронная почта:** [org@eplast1.ru](mailto:org@eplast1.ru)

**Адрес:** 198099, г. Санкт-Петербург, ул. Калинина, дом 2, корпус 4, литера А.