

100V INPUT, 12V 30mA REGULATOR TRANSISTOR

Description

The ZXTR2012Z monolithically integrates a transistor, Zener diode and resistor to function as a high voltage linear regulator. The device regulates with a 12V nominal output at 15mA. It is designed for use in high voltage applications where standard linear regulators cannot be used. This function is fully integrated into a SOT89 package, minimizing PCB area and reducing number of components when compared with a multi-chip discrete solution.

Applications

- Supply voltage regulation in:
- Networking
 - Telecom
 - Power Over Ethernet (PoE)

Features

- Series Linear Regulator Using Emitter-Follower Stage
- Input Voltage = 15V to 100V
- Output Voltage = 12V ± 10%
- Fully integrated into a SOT89 Package
- **Totally Lead-Free & Fully RoHS compliant (Notes 1 & 2)**
- **Halogen and Antimony Free. "Green" Device (Note 3)**
- **Qualified to AEC-Q101 Standards for High Reliability**

Mechanical Data

- Case: SOT89
- Case Material: Molded Plastic. "Green" Molding Compound.
- UL Flammability Rating 94V-0
- Moisture Sensitivity: Level 1 per J-STD-020
- Terminals: Finish - Matte Tin Plated Leads, Solderable per MIL-STD-202, Method 208 
- Weight: 0.052 grams (approximate)

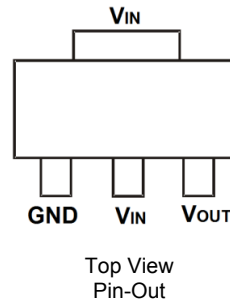
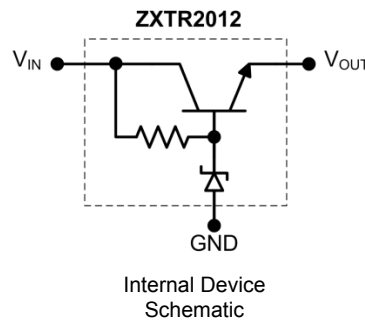
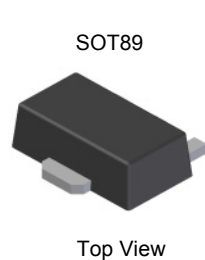

| Pin Name | Pin Function |
|------------------|----------------|
| V _{IN} | Input Supply |
| GND | Power Ground |
| V _{OUT} | Voltage Output |

Ordering Information (Note 4)

| Product | Package | Marking | Reel size (inches) | Tape width (mm) | Quantity per reel |
|--------------|---------|---------|--------------------|-----------------|-------------------|
| ZXTR2012Z-7 | SOT89 | 1T4 | 7 | 12 | 1,000 |
| ZXTR2012Z-13 | SOT89 | 1T4 | 13 | 12 | 2,500 |

- Notes:
1. No purposely added lead. Fully EU Directive 2002/95/EC (RoHS) & 2011/65/EU (RoHS 2) compliant.
 2. See http://www.diodes.com/quality/lead_free.html for more information about Diodes Incorporated's definitions of Halogen and Antimony free, "Green" and Lead-Free.
 3. Halogen and Antimony free "Green" products are defined as those which contain <900ppm bromine, <900ppm chlorine (<1500ppm total Br + Cl) and <1000ppm antimony compounds.
 4. For packaging details, go to our website at <http://www.diodes.com/products/packages.html>.

Marking Information

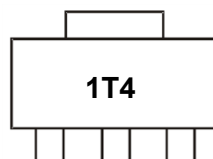

1T4 = Product Type Marking Code

Absolute Maximum Ratings (Voltage relative to GND, @T_A = +25°C, unless otherwise specified.)

| Characteristic | Symbol | Value | Unit |
|---|------------------------------------|-------------|------|
| Input Supply Voltage | V _{IN} | -0.3 to 100 | V |
| Continuous Input & Output Current | I _{IN} , I _{OUT} | 550 | mA |
| Peak Pulsed Input & Output Current | I _{IM} , I _{OM} | 2 | A |
| Maximum Voltage applied to V _{OUT} | V _{OUT(max)} | 18 | V |

Maximum Current at V_{IN} = 48V (@T_A = +25°C, unless otherwise specified.)

| Characteristic | Symbol | Value | Unit |
|---------------------------|------------------|-------|------|
| Continuous Output Current | I _{OUT} | 47 | mA |
| Pulsed Output Current | I _{OM} | 880 | mA |
| | | 180 | |

Thermal Characteristics

| Characteristic | Symbol | Value | Unit |
|--|-----------------------------------|-------------|------|
| Power Dissipation | P _D | 1.7 | W |
| | | 0.89 | |
| Thermal Resistance, Junction to Ambient | R _{θJA} | 59 | °C/W |
| | | 112 | |
| Thermal Resistance, Junction to Lead | R _{θJL} | 20 | |
| Thermal Resistance, Junction to Case | R _{θJC} | 15.7 | |
| Recommended Operating Junction Temperature Range | T _J | -40 to +125 | °C |
| Maximum Operating Junction and Storage Temperature Range | T _J , T _{STG} | -65 to +150 | |

ESD Ratings (Note 11)

| Characteristics | Symbols | Value | Unit | JEDEC Class |
|--|---------|-------|------|-------------|
| Electrostatic Discharge – Human Body Model | ESD HBM | 4000 | V | 3A |
| Electrostatic Discharge – Machine Model | ESD MM | 400 | V | C |

- Notes:
- For a device mounted with the exposed V_{IN} pad on 50mm x 50mm 1oz copper that is on a single-sided 1.6mm FR4 PCB; device is measured under still air conditions whilst operating in steady-state.
 - Same as note 5, except mounted on 15mm x 15mm 1oz copper.
 - Same as note 5, whilst operating at V_{IN} = 48V. Refer to Safe Operating Area for other Input Voltages.
 - Same as note 5, except measured with a single pulse width = 100µs and V_{IN} = 48V.
 - Same as note 5, except measured with a single pulse width = 10ms and V_{IN} = 48V.
 - R_{θJL} = Thermal resistance from junction to solder-point (on the exposed V_{IN} pad).
 - R_{θJC} = Thermal resistance from junction to the top of case.
 - Refer to JEDEC specification JESD22-A114 and JESD22-A115.

Thermal Characteristics and Derating Information

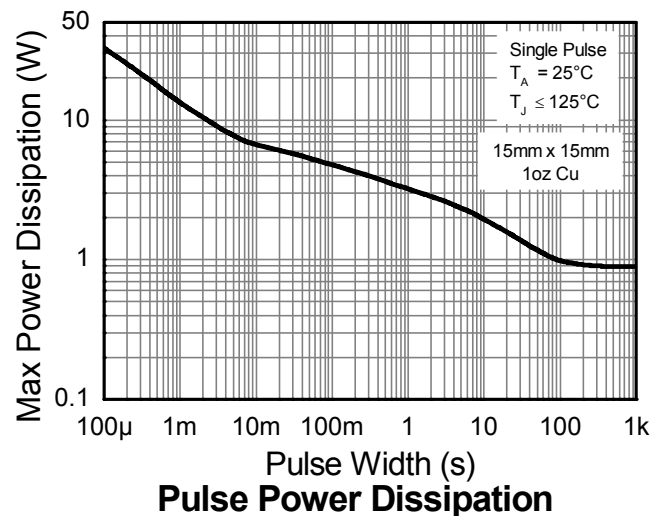
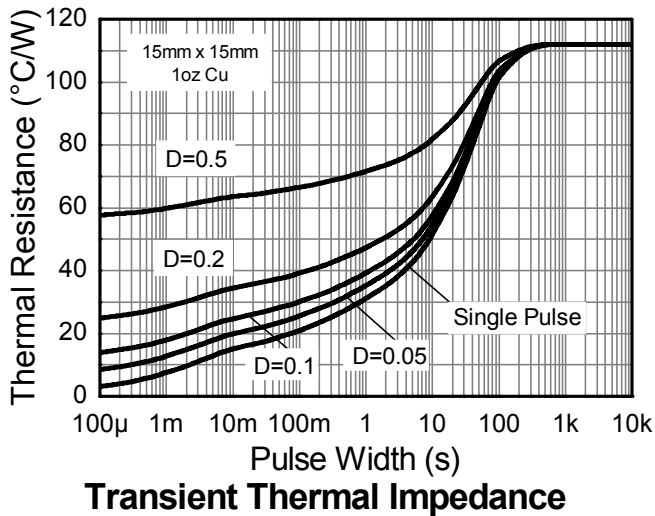
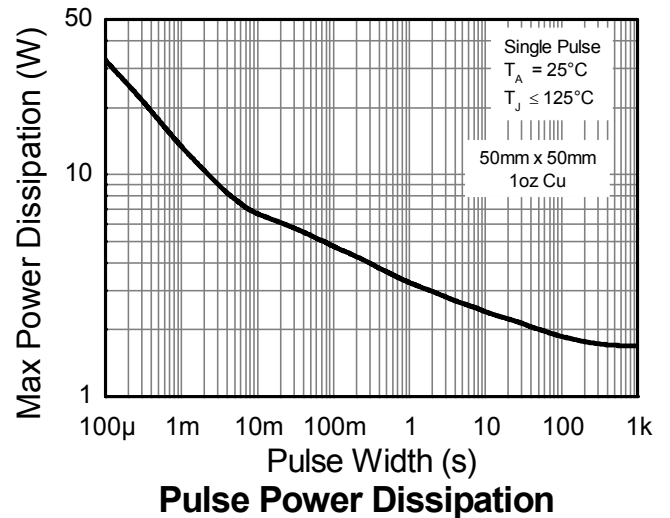
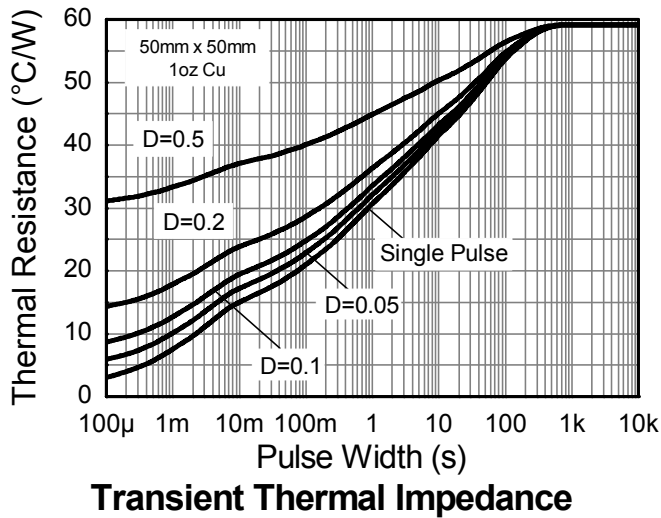
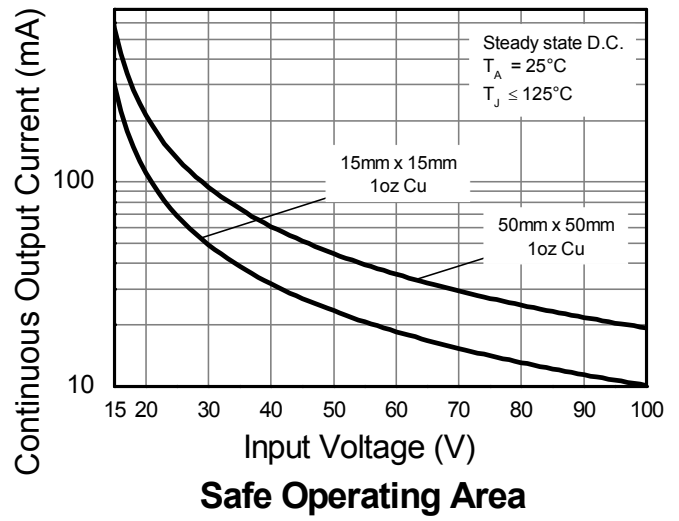
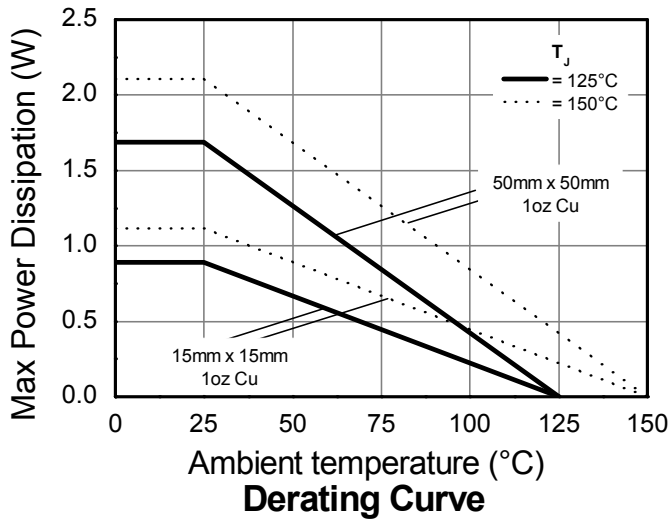

Electrical Characteristics (@T_A = +25°C, unless otherwise specified.)

| Characteristic | Symbol | Min | Typ | Max | Unit | Test Condition |
|---|-------------------------------------|------|--------------|--------------|-------|---|
| Output Voltage (Note 12) | V _{OUT} | 10.8 | 12 | 13.2 | V | V _{IN} = 48V, I _{OUT} = 15mA |
| Line Regulation (Notes 12 & 13) | ΔV _{OUT} | — | 240 | 750 | mV | V _{IN} = 15 to 72V, I _{OUT} = 15mA |
| Temperature Coefficient | ΔV _{OUT} /ΔT | — | 8.0 | — | mV/°C | T _J = -40°C to +125°C V _{IN} = 48V, I _{OUT} = 15mA |
| Load Regulation (Notes 12 & 14) | ΔV _{OUT} | — | -450 -600 | -600 -750 | mV | I _{OUT} = 0.1 to 30mA, V _{IN} = 48V I _{OUT} = 0.1 to 100mA, V _{IN} = 48V |
| Minimum Value of Input Voltage Required to Maintain Line Regulation | V _{IN(MIN)} | 15 | — | — | V | — |
| Quiescent Current | I _Q | — | 240 590 | 400 900 | μA | V _{IN} = 48V, I _{OUT} = 10μA V _{IN} = 100V, I _{OUT} = 10μA |
| Power Supply Rejection Ratio | ΔV _{IN} /ΔV _{OUT} | — | 45 | — | dB | C _{OUT} = 100nF, I _{OUT} = 15mA, V _{OUT} = 12V, V _{IN} = 15 to 100V, f=100Hz |

Notes: 12. Measured under pulsed conditions. Pulse width ≤ 300μs. Duty cycle ≤ 2%.
 13. Line regulation ΔV_{OUT} = V_{OUT}(@ V_{IN} = 72V) – V_{OUT}(@ V_{IN} = 15V)
 14. Load regulation ΔV_{OUT} = V_{OUT}(@ I_{OUT} = 30mA) – V_{OUT}(@ I_{OUT} = 0.1mA)
 ΔV_{OUT} = V_{OUT}(@ I_{OUT} = 100mA) – V_{OUT}(@ I_{OUT} = 0.1mA)

Typical Application Circuit

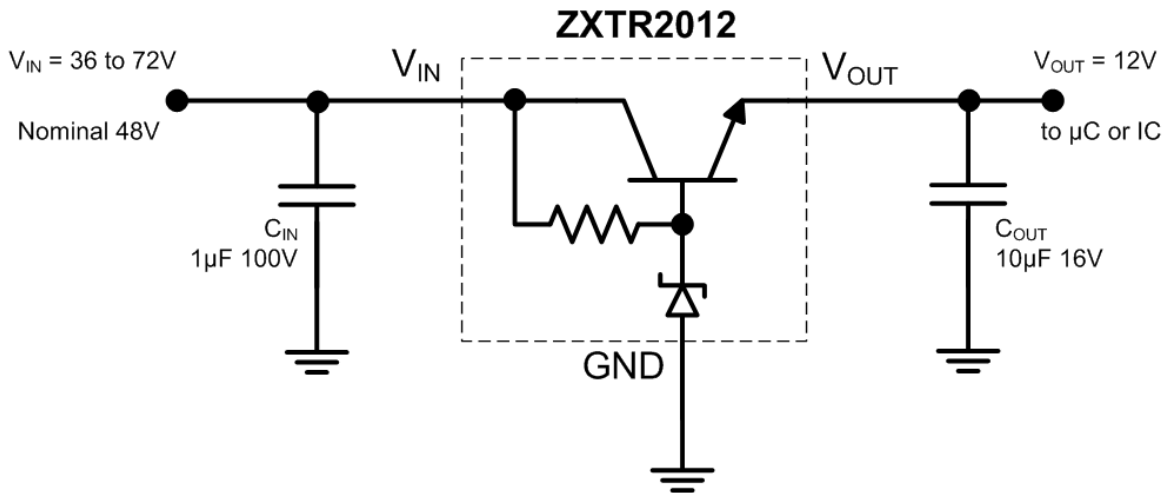

Example of an 12V regulated supply from a nominal 48V for powering a Controller IC.

Pin Functions

| Pin Name | Pin Function | Notes |
|------------------|----------------|---|
| V _{IN} | Input Supply | To maintain output regulation the input voltage can vary from 15V to 100V with respect to the GND pin. It is recommended to connect a 1μF capacitor to GND. |
| GND | Power Ground | This pin should be tied to the system ground. |
| V _{OUT} | Voltage Output | Outputs a regulated 12V. It is recommended to connect a 10μF capacitor to GND. Minimum of 10μA must be drawn from V _{OUT} to maintain regulation. The pin can be pulled high to a maximum of 18V with respect to ground. |

Typical Electrical Characteristics (@ $T_A = +25^\circ\text{C}$, unless otherwise specified.)

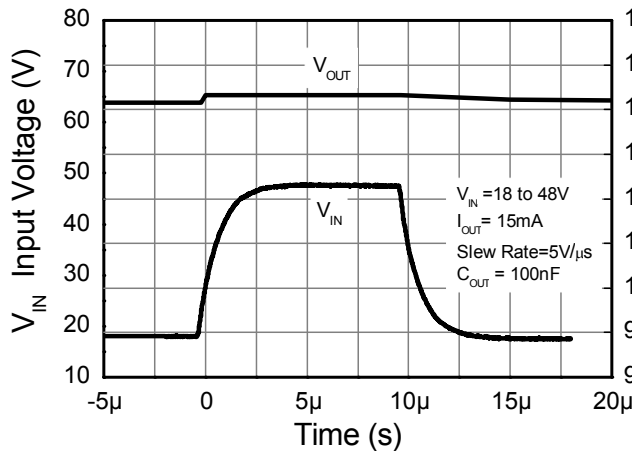

Line transient response

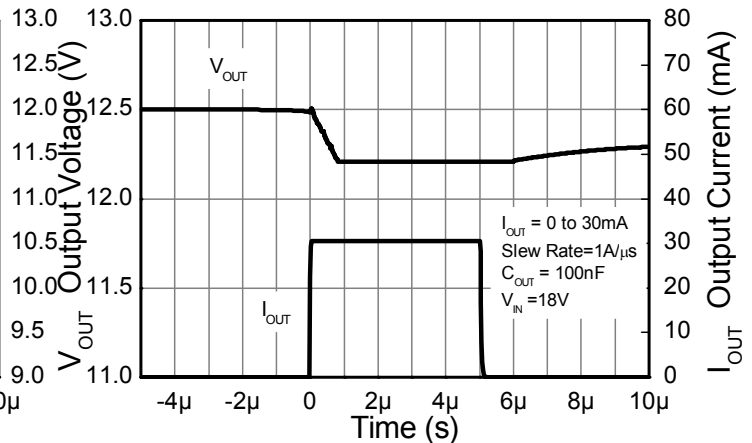

Load transient response

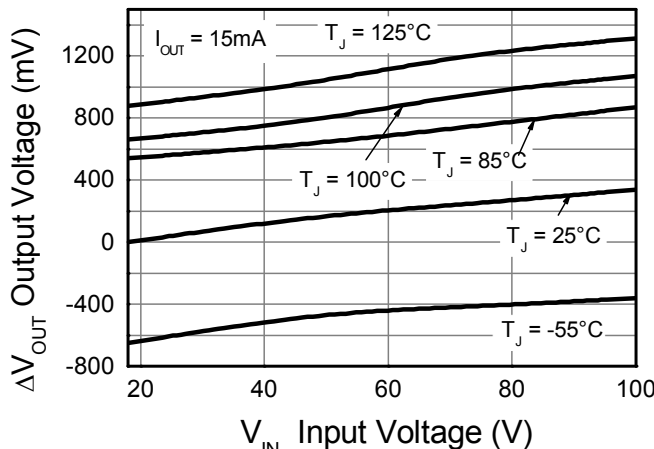

Line Regulation (Note 15)

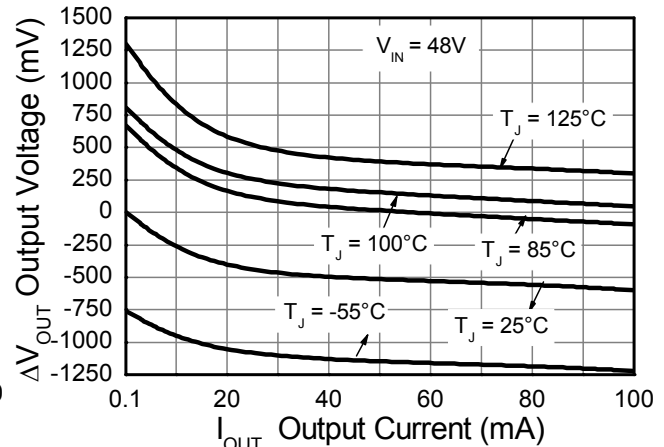

Load Regulation (Note 16)

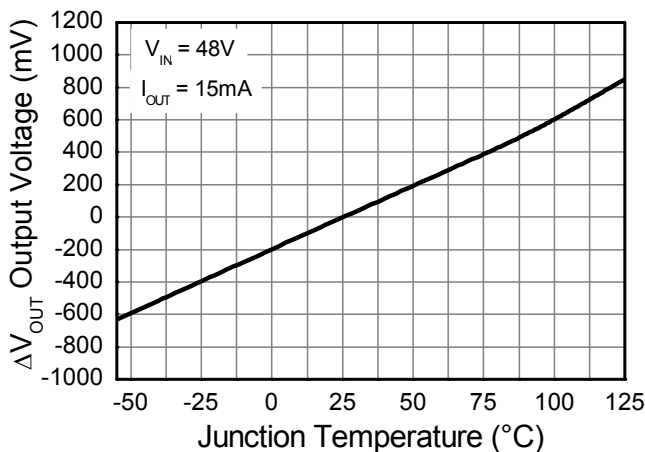

Temperature Coefficient (Note 17)

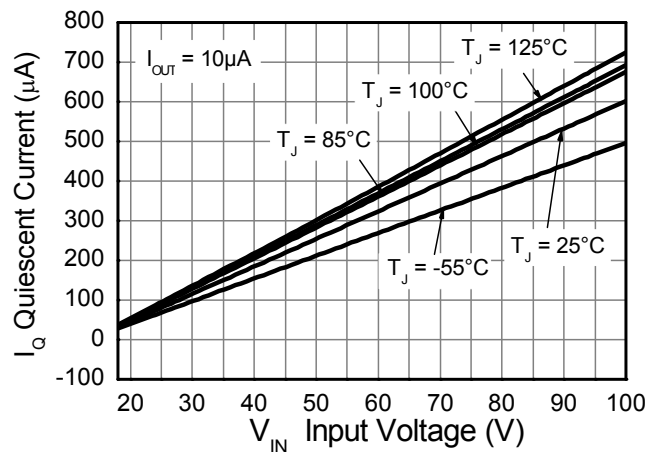

Quiescent Current

- Notes:
- 15. Line regulation $\Delta V_{OUT} = V_{OUT} - V_{OUT}(@ V_{IN} = 15\text{V}, I_{OUT} = 15\text{mA}, T_J = +25^\circ\text{C})$
 - 16. Load regulation $\Delta V_{OUT} = V_{OUT} - V_{OUT}(@ V_{IN} = 48\text{V}, I_{OUT} = 0.1\text{mA}, T_J = +25^\circ\text{C})$
 - 17. Temperature Coefficient $\Delta V_{OUT} = V_{OUT} - V_{OUT}(@ V_{IN} = 48\text{V}, I_{OUT} = 15\text{mA}, T_J = +25^\circ\text{C})$

Package Outline Dimensions

Please see AP02002 at <http://www.diodes.com/datasheets/ap02002.pdf> for latest version.

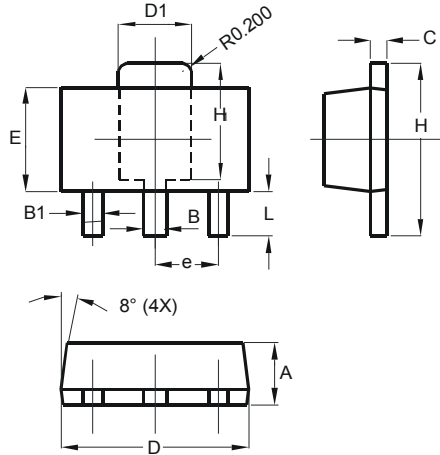

| SOT89 | | |
|----------------------|----------|------|
| Dim | Min | Max |
| A | 1.40 | 1.60 |
| B | 0.44 | 0.62 |
| B1 | 0.35 | 0.54 |
| C | 0.35 | 0.44 |
| D | 4.40 | 4.60 |
| D1 | 1.62 | 1.83 |
| E | 2.29 | 2.60 |
| e | 1.50 Typ | |
| H | 3.94 | 4.25 |
| H1 | 2.63 | 2.93 |
| L | 0.89 | 1.20 |
| All Dimensions in mm | | |

Suggested Pad Layout

Please see AP02001 at <http://www.diodes.com/datasheets/ap02001.pdf> for the latest version.

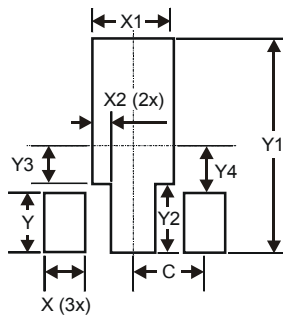

| Dimensions | Value (in mm) |
|------------|---------------|
| X | 0.900 |
| X1 | 1.733 |
| X2 | 0.416 |
| Y | 1.300 |
| Y1 | 4.600 |
| Y2 | 1.475 |
| Y3 | 0.950 |
| Y4 | 1.125 |
| C | 1.500 |

IMPORTANT NOTICE

DIODES INCORPORATED MAKES NO WARRANTY OF ANY KIND, EXPRESS OR IMPLIED, WITH REGARDS TO THIS DOCUMENT, INCLUDING, BUT NOT LIMITED TO, THE IMPLIED WARRANTIES OF MERCHANTABILITY AND FITNESS FOR A PARTICULAR PURPOSE (AND THEIR EQUIVALENTS UNDER THE LAWS OF ANY JURISDICTION).

Diodes Incorporated and its subsidiaries reserve the right to make modifications, enhancements, improvements, corrections or other changes without further notice to this document and any product described herein. Diodes Incorporated does not assume any liability arising out of the application or use of this document or any product described herein; neither does Diodes Incorporated convey any license under its patent or trademark rights, nor the rights of others. Any Customer or user of this document or products described herein in such applications shall assume all risks of such use and will agree to hold Diodes Incorporated and all the companies whose products are represented on Diodes Incorporated website, harmless against all damages.

Diodes Incorporated does not warrant or accept any liability whatsoever in respect of any products purchased through unauthorized sales channel. Should Customers purchase or use Diodes Incorporated products for any unintended or unauthorized application, Customers shall indemnify and hold Diodes Incorporated and its representatives harmless against all claims, damages, expenses, and attorney fees arising out of, directly or indirectly, any claim of personal injury or death associated with such unintended or unauthorized application.

Products described herein may be covered by one or more United States, international or foreign patents pending. Product names and markings noted herein may also be covered by one or more United States, international or foreign trademarks.

This document is written in English but may be translated into multiple languages for reference. Only the English version of this document is the final and determinative format released by Diodes Incorporated.

LIFE SUPPORT

Diodes Incorporated products are specifically not authorized for use as critical components in life support devices or systems without the express written approval of the Chief Executive Officer of Diodes Incorporated. As used herein:

A. Life support devices or systems are devices or systems which:

1. are intended to implant into the body, or
2. support or sustain life and whose failure to perform when properly used in accordance with instructions for use provided in the labeling can be reasonably expected to result in significant injury to the user.

B. A critical component is any component in a life support device or system whose failure to perform can be reasonably expected to cause the failure of the life support device or to affect its safety or effectiveness.

Customers represent that they have all necessary expertise in the safety and regulatory ramifications of their life support devices or systems, and acknowledge and agree that they are solely responsible for all legal, regulatory and safety-related requirements concerning their products and any use of Diodes Incorporated products in such safety-critical, life support devices or systems, notwithstanding any devices- or systems-related information or support that may be provided by Diodes Incorporated. Further, Customers must fully indemnify Diodes Incorporated and its representatives against any damages arising out of the use of Diodes Incorporated products in such safety-critical, life support devices or systems.

Copyright © 2013, Diodes Incorporated

www.diodes.com



Компания «ЭлектроПласт» предлагает заключение долгосрочных отношений при поставках импортных электронных компонентов на взаимовыгодных условиях!

Наши преимущества:

- Оперативные поставки широкого спектра электронных компонентов отечественного и импортного производства напрямую от производителей и с крупнейших мировых складов;
- Поставка более 17-ти миллионов наименований электронных компонентов;
- Поставка сложных, дефицитных, либо снятых с производства позиций;
- Оперативные сроки поставки под заказ (от 5 рабочих дней);
- Экспресс доставка в любую точку России;
- Техническая поддержка проекта, помощь в подборе аналогов, поставка прототипов;
- Система менеджмента качества сертифицирована по Международному стандарту ISO 9001;
- Лицензия ФСБ на осуществление работ с использованием сведений, составляющих государственную тайну;
- Поставка специализированных компонентов (Xilinx, Altera, Analog Devices, Intersil, Interpoint, Microsemi, Aeroflex, Peregrine, Syfer, Eurofarad, Texas Instrument, Miteq, Cobham, E2V, MA-COM, Hittite, Mini-Circuits, General Dynamics и др.);

Помимо этого, одним из направлений компании «ЭлектроПласт» является направление «Источники питания». Мы предлагаем Вам помощь Конструкторского отдела:

- Подбор оптимального решения, техническое обоснование при выборе компонента;
- Подбор аналогов;
- Консультации по применению компонента;
- Поставка образцов и прототипов;
- Техническая поддержка проекта;
- Защита от снятия компонента с производства.



Как с нами связаться

Телефон: 8 (812) 309 58 32 (многоканальный)

Факс: 8 (812) 320-02-42

Электронная почта: org@eplast1.ru

Адрес: 198099, г. Санкт-Петербург, ул. Калинина, дом 2, корпус 4, литера А.