

SECTION Z-Z

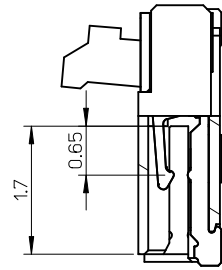

SECTION Y-Y

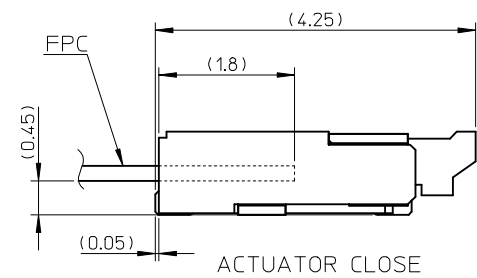
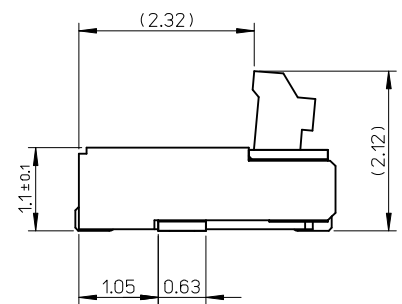

ACTUATOR CLOSE

15.6	15.8	14.4	15.0	17.2	501616-5185	501616-5150	51
13.8	14.0	12.6	13.2	15.4	501616-4585	501616-4550	45
12.6	12.8	11.4	12.0	14.2	501616-4185	501616-4150	41
12.0	12.2	10.8	11.4	13.6	501616-3985	501616-3950	39
10.8	11.0	9.6	10.2	12.4	501616-3585	501616-3550	35
E	D	(C)	(B)	A	EMBOSSED TAPE ORDER No.		MATERIAL NO. CIRCUIT

部品構成

- ハウジング・・・材質：耐熱性樹脂 黒色 UL94V-0
HOUSING MATERIAL :HEAT RESISTANT POLYMER BLACK UL94-V0
- 奇数ターミナル・・・材質：銅合金
ODD TERMINAL MATERIAL :COPPER ALLOY
処理：ニッケル下地部分金メッキ（接触部及びテール部）
FINISH :PARTLY GOLD(CONTACT,TAIL) OVER NICKEL PLATING
- 偶数ターミナル・・・材質：銅合金
EVEN TERMINAL MATERIAL:COPPER ALLOY
処理：ニッケル下地部分金メッキ（接触部及びテール部）
FINISH :PARTLY GOLD(CONTACT,TAIL) OVER NICKEL PLATING
- アクチュエータ・・・材質：耐熱性樹脂 灰色 UL94V-0
ACTUATOR MATERIAL :HEAT RESISTANT POLYMER GRAY UL94-V0
- ネイル・・・材質：銅合金
NAIL MATERIAL:COPPER ALLOY
処理：ニッケル下地すずめっき
FINISH :TIN OVER NICKEL PLATING

REVISED EC NO: J2009-1320 DRAWN: TAKAHASHI 03/2008/11/21 CHKD: THARUYAMA 2008/11/21 APPR: NUKITA 2008/11/21	DESCRIPTION	GENERAL TOLERANCES (UNLESS SPECIFIED)		DIMENSION STYLE MM ONLY		SCALE 15:1	DESIGN UNITS METRIC	THIRD ANGLE PROJECTION		
		10 UNDER	± 0.2	DRAWN BY K. SATO	DATE 2007/01/26	TITLE 0.3 FPC CONN. E/O H=1.1 HSG ASSY LONG ACTUATOR				
		10 OVER 30 UNDER	± 0.25	CHECKED BY H. HIRATA	DATE 2007/01/26	MATERIAL NO. DOCUMENT NO.				
		30 OVER	± 0.3	APPROVED BY M. SASAO	DATE 2007/01/26	SHEET NO. 1 OF 2				
ANGULAR ± 3 °		DRAFT WHERE APPLICABLE MUST REMAIN WITHIN DIMENSIONS		SEE CHART		MOLEX INCORPORATED SD-501616-007				
THIS DRAWING CONTAINS INFORMATION THAT IS PROPRIETARY TO MOLEX INCORPORATED AND SHOULD NOT BE USED WITHOUT WRITTEN PERMISSION										

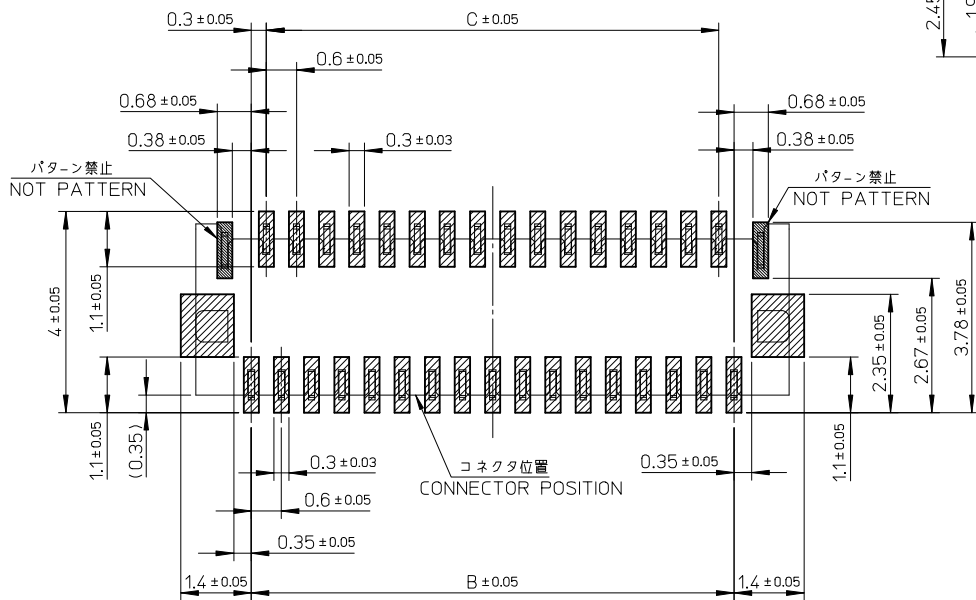

参考基板レイアウト (マウント面)
P.C. BOARD PATTERN DIM.(REF.)

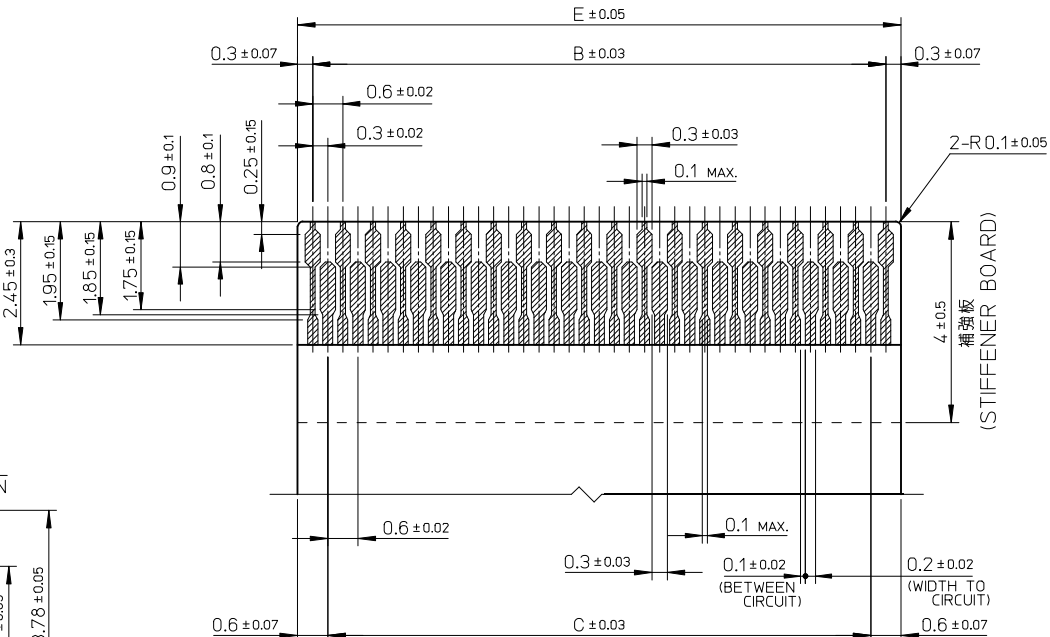

適合FPC推奨寸法
仕上がり厚さ : 0.2±0.03
APPLY FPC
RECOMMENDED DIM.
THICKNESS : 0.2±0.03

15.6	14.4	15.0	501616-5185	501616-5150	51
13.8	12.6	13.2	501616-4585	501616-4550	45
12.6	11.4	12.0	501616-4185	501616-4150	41
12.0	10.8	11.4	501616-3985	501616-3950	39
10.8	9.6	10.2	501616-3585	501616-3550	35
E	C	B	EMBOSSD TAPE ORDER No.	MATERIAL NO.	CIRCUIT

- 注記
- 基板実装前にアクチュエータを操作しないで下さい。
PLEASE DO NOT OPERATE THE ACTUATOR BEFORE MOUNTING.
必ず基板に実装し、FPCを挿入してからアクチュエータを操作して下さい。
PLEASE OPERATE THE ACTUATOR AFTER MOUNTING ON THE SUBSTRATE, AND MATING FPC.
 - ELV及びRoHS適合品
ELV AND RoHS COMPLIANT

REVISED EC NO: J2009-1320 DRAWN: TAKAHASHI 03 2008/11/24 CHKD: THARUYAMA 2008/11/24 APPR: NUKITA 2008/11/24	DESCRIPTION	GENERAL TOLERANCES (UNLESS SPECIFIED)		DIMENSION STYLE MM ONLY		SCALE 10:1	DESIGN UNITS METRIC	THIRD ANGLE PROJECTION	
		10 UNDER	±0.2	DRAWN BY K. SATO	DATE 2007/01/26	TITLE 0.3 FPC CONN. E/O H=1.1 HSG ASSY LONG ACTUATOR			
		10 OVER 30 UNDER	±0.25	CHECKED BY H. HIRATA	DATE 2007/01/26	MOLEX MOLEX INCORPORATED DOCUMENT NO. SD-501616-007 SHEET NO. 2 OF 2			
		30 OVER	±0.3	APPROVED BY M. SASAO	DATE 2007/01/26				
		ANGULAR ±3 ° DRAFT WHERE APPLICABLE MUST REMAIN WITHIN DIMENSIONS		MATERIAL NO. SEE CHART		THIS DRAWING CONTAINS INFORMATION THAT IS PROPRIETARY TO MOLEX INCORPORATED AND SHOULD NOT BE USED WITHOUT WRITTEN PERMISSION			

NOTES

- 製品 (501616-**50) の詳細寸法については、図面 SD-501616-007 をご参照下さい。
IN THE PACKAGE, PART NO. 501616-**50 DETAILED DIMENSIONS, REFER TO SALES DRAWING NO. SD-501616-007.
- 梱包数量 : 3000個/リール
NUMBER OF CONNECTORS : 3000 PCS/REEL
- リードテープ長さ
LEAD TAPE LENGTH

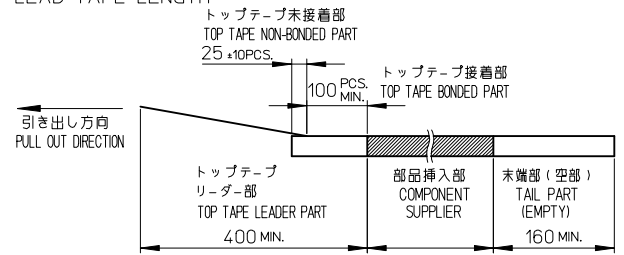

- 材料
キャリアテープ : ポリスチレン (PS)
トップテープ : PET, PE, PEF
リール : ポリスチレン (PS) <リサイクル材を含む>
MATERIAL
CARRIER TAPE : POLYSTYRENE (PS)
TOP TAPE : PET, PE, PEF
REEL : POLYSTYRENE (PS) <RECYCLE MATERIAL CONTAINED>
- ELV及びRoHS適合品
ELV AND RoHS COMPLIANT

37.4	33.4	32±0.3	28.4	14.2	15.4	17.4	501616-5185	51
					13.6	15.6	501616-4585	45
29.4	25.4	24±0.3	++	11.5	12.4	14.4	501616-4185	41
					11.8	13.8	501616-3985	39
					10.6	12.6	501616-3585	35
G	F	E キャリアテープ幅 EMBOSSED TAPE WIDTH	D	C	B	A	EMBOSSED PACKAGE オーダー番号 ORDER No.	極数 CIRCUIT

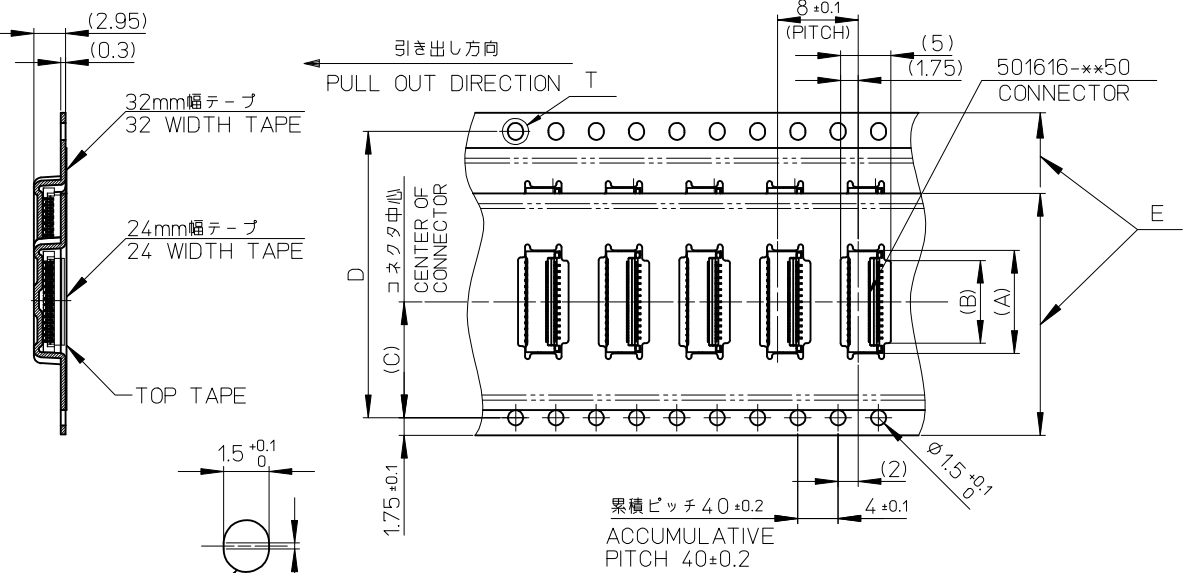
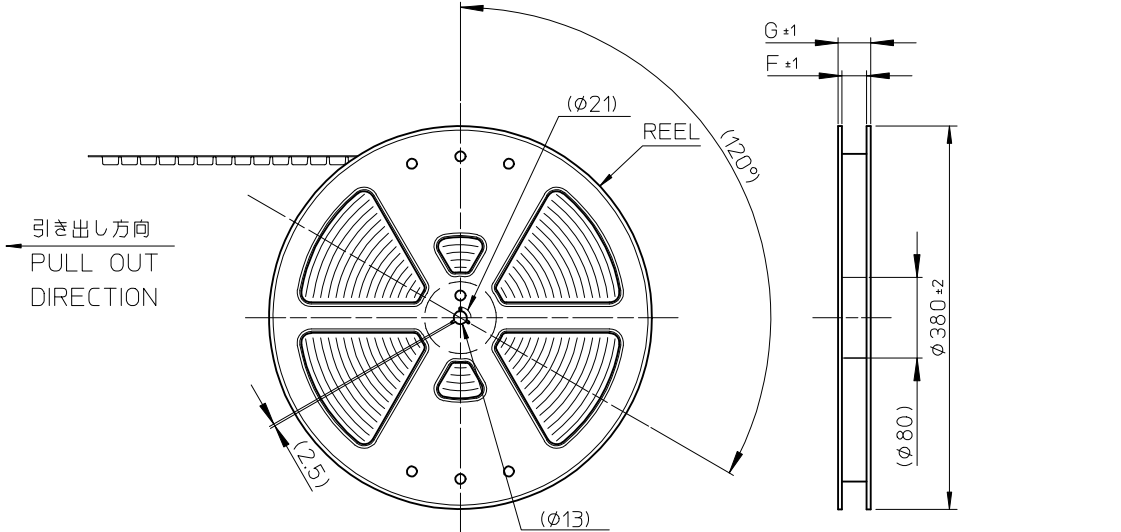

REVISED EC NO: J2009-1784 DRWN:MKAWABATA 2009/01/26 CHKD:HSHIROYAMA 2009/01/26 APPR:HSHIROYAMA 2009/01/26	GENERAL TOLERANCES (UNLESS SPECIFIED)	DIMENSION STYLE MM ONLY	SCALE ---	DESIGN UNITS METRIC	THIRD ANGLE PROJECTION
	10 UNDER ± ---	DRAWN BY K. SATO	DATE 2007/05/14	TITLE 0.3 FPC CONN. H=1.1 EMBSTP PKG (LONG-ACT)	
	10 OVER 30 UNDER ± ---	CHECKED BY H. HIRATA	DATE 2007/05/14	MOLEX INCORPORATED	
	30 OVER ± ---	APPROVED BY M. SASAO	DATE 2007/05/14	DOCUMENT NO. SD-501616-008	SHEET NO. 1 OF 1
ANGULAR ± --- °	DRAFT WHERE APPLICABLE MUST REMAIN WITHIN DIMENSIONS		SEE CHART		
SIZE A3	THIS DRAWING CONTAINS INFORMATION THAT IS PROPRIETARY TO MOLEX INCORPORATED AND SHOULD NOT BE USED WITHOUT WRITTEN PERMISSION				



Компания «ЭлектроПласт» предлагает заключение долгосрочных отношений при поставках импортных электронных компонентов на взаимовыгодных условиях!

Наши преимущества:

- Оперативные поставки широкого спектра электронных компонентов отечественного и импортного производства напрямую от производителей и с крупнейших мировых складов;
- Поставка более 17-ти миллионов наименований электронных компонентов;
- Поставка сложных, дефицитных, либо снятых с производства позиций;
- Оперативные сроки поставки под заказ (от 5 рабочих дней);
- Экспресс доставка в любую точку России;
- Техническая поддержка проекта, помощь в подборе аналогов, поставка прототипов;
- Система менеджмента качества сертифицирована по Международному стандарту ISO 9001;
- Лицензия ФСБ на осуществление работ с использованием сведений, составляющих государственную тайну;
- Поставка специализированных компонентов (Xilinx, Altera, Analog Devices, Intersil, Interpoint, Microsemi, Aeroflex, Peregrine, Syfer, Eurofarad, Texas Instrument, Miteq, Cobham, E2V, MA-COM, Hittite, Mini-Circuits, General Dynamics и др.);

Помимо этого, одним из направлений компании «ЭлектроПласт» является направление «Источники питания». Мы предлагаем Вам помощь Конструкторского отдела:

- Подбор оптимального решения, техническое обоснование при выборе компонента;
- Подбор аналогов;
- Консультации по применению компонента;
- Поставка образцов и прототипов;
- Техническая поддержка проекта;
- Защита от снятия компонента с производства.



Как с нами связаться

Телефон: 8 (812) 309 58 32 (многоканальный)

Факс: 8 (812) 320-02-42

Электронная почта: org@eplast1.ru

Адрес: 198099, г. Санкт-Петербург, ул. Калинина, дом 2, корпус 4, литера А.