

Cree® XLamp® CXA1520 LED



PRODUCT DESCRIPTION

The XLamp® CXA1520 LED is Cree's first High Density (HD) LED array, featuring a 9-mm optical source and enabling lighting manufacturers to create a new generation of products that delivers the same intensity and light quality as 39-W ceramic metal halide (CMH) at up to 50 percent lower power. The new HD class of CXA arrays provide unrivaled lumen density that can reduce system cost for the next generation of LED spotlights.

The [CX Family LED Design Guide](#) provides basic information on the requirements to use the CXA1520 LED successfully in luminaire designs.

FEATURES

- Available in 4-step, 3-step and 2-step EasyWhite® bins at 2700 K, 3000 K, 3500 K, 4000 K and 5000 K CCT
- Available in ANSI white bins at 4000 K and 5000 K CCT
- Available in 70-, 80-, 90- and 93-minimum CRI options
- Forward voltage option: 36-V class
- 85 °C binning and characterization
- Maximum drive current: 900 mA
- 115° viewing angle, uniform chromaticity profile
- Top-side solder connections
- Thermocouple attach point
- NEMA SSL-3 2011 standard flux bins
- RoHS- and REACH-compliant
- UL® recognized component (E349212)

TABLE OF CONTENTS

Characteristics	2
Operating Limits	2
Flux Characteristics, EasyWhite® Order Codes and Bins	3
Flux Characteristics, ANSI White Order Codes and Bins	5
Relative Spectral Power Distribution	6
Electrical Characteristics	6
Relative Luminous Flux	7
Typical Spatial Distribution	8
Performance Groups - Brightness	8
Performance Groups - Chromaticity	9
Cree EasyWhite® Bins Plotted on the 1931 CIE Color Space	11
Cree ANSI White Bins Plotted on the 1931 CIE Color Space	12
Bin and Order Code Formats	13
Mechanical Dimensions	13
Thermal Design	14
Notes	15
Packaging	16



CHARACTERISTICS

Characteristics	Unit	Minimum	Typical	Maximum
Viewing angle (FWHM)	degrees		115	
ESD withstand voltage (HBM per Mil-Std-883D)	V			8000
DC forward current	mA			900*
Reverse current	mA			0.1
Forward voltage (@ 500 mA, 85 °C)	V		35	
Forward voltage (@ 500 mA, 25 °C)	V			42

* Refer to the Operating Limits section.

OPERATING LIMITS

The maximum current rating of the CXA1520 is dependent on the case temperature (T_c) when the LED has reached thermal equilibrium under steady-state operation. The graph shown below assumes that the system design employs good thermal management (thermal interface material and heat sink) and may vary when poor thermal management is employed. Please refer to the Mechanical Dimensions section on page 13 for the location of the T_c measurement point.



FLUX CHARACTERISTICS, EASYWHITE® ORDER CODES AND BINS ($I_F = 500 \text{ mA}$, $T_J = 85 \text{ °C}$)

The following table provides order codes for XLamp CXA1520 LEDs. For a complete description of the order code nomenclature, please see the Bin and Order Code Formats section (page 13).

Nominal CCT	CRI		Minimum Luminous Flux			2-Step		3-Step		4-Step		
	Min	Typ	Group	Flux (lm) @ 85 °C	Flux (lm) @ 25 °C*	Group	Order Code	Group	Order Code	Group	Order Code	
5000 K	70	75	P2	1830	2028	50H	CXA1520-0000-000N00P250H			50F	CXA1520-0000-000N00P250F	
			P4	1965	2177		CXA1520-0000-000N00P450H				CXA1520-0000-000N00P450F	
			Q2	2100	2327		CXA1520-0000-000N00Q250H				CXA1520-0000-000N00Q250F	
	80	---	N4	1710	1895	50H	CXA1520-0000-000N0HN450H	50G		50F	CXA1520-0000-000N0HN450G	CXA1520-0000-000N0HN450F
			P2	1830	2028		CXA1520-0000-000N0HP250H				CXA1520-0000-000N0HP250G	CXA1520-0000-000N0HP250F
			P4	1965	2177		CXA1520-0000-000N0HP450H				CXA1520-0000-000N0HP450G	CXA1520-0000-000N0HP450F
	90	95	M4	1485	1645	50H	CXA1520-0000-000N0UM450H	50G		50F	CXA1520-0000-000N0UM450G	CXA1520-0000-000N0UM450F
			N2	1590	1762		CXA1520-0000-000N0UN250H				CXA1520-0000-000N0UN250G	CXA1520-0000-000N0UN250F
	4000 K	70	75	N4	1710	1895	40H	CXA1520-0000-000N00N440H			40F	CXA1520-0000-000N00N440F
P2				1830	2028	CXA1520-0000-000N00P240H		CXA1520-0000-000N00P240F				
P4				1965	2177	CXA1520-0000-000N00P440H		CXA1520-0000-000N00P440F				
80		---	N2	1590	1762	40H	CXA1520-0000-000N0HN240H	40G		40F	CXA1520-0000-000N0HN240G	CXA1520-0000-000N0HN240F
			N4	1710	1895		CXA1520-0000-000N0HN440H				CXA1520-0000-000N0HN440G	CXA1520-0000-000N0HN440F
			P2	1830	2028		CXA1520-0000-000N0HP240H				CXA1520-0000-000N0HP240G	CXA1520-0000-000N0HP240F
90		95	M2	1380	1587	40H	CXA1520-0000-000N0UM240H	40G		40F	CXA1520-0000-000N0UM240G	CXA1520-0000-000N0UM240F
			M4	1485	1645		CXA1520-0000-000N0UM440H				CXA1520-0000-000N0UM440G	CXA1520-0000-000N0UM440F

- Notes
- Cree maintains a tolerance of $\pm 7\%$ on flux and power measurements, ± 0.005 on chromaticity (CCx, CCy) measurements and a tolerance of ± 2 on CRI measurements. See the Measurements section (page 15).
 - Cree XLamp CXA1520 LED order codes specify only a minimum flux bin and not a maximum. Cree may ship reels in flux bins higher than the minimum specified by the order code without advance notice. Shipments will always adhere to the chromaticity bin restrictions specified by the order code.
 - * Flux values @ 25 °C are calculated and for reference only.

FLUX CHARACTERISTICS, EASYWHITE® ORDER CODES AND BINS ($I_F = 500 \text{ mA}$, $T_J = 85 \text{ °C}$) - CONTINUED

Nominal CCT	CRI		Minimum Luminous Flux			2-Step		3-Step		4-Step	
	Min	Typ	Group	Flux (lm) @ 85 °C	Flux (lm) @ 25 °C*	Group	Order Code	Group	Order Code	Group	Order Code
3500 K	80	---	N2	1590	1762	35H	CXA1520-0000-000N00N235H	35G	CXA1520-0000-000N00N235G	35F	CXA1520-0000-000N00N235F
			N4	1710	1895		CXA1520-0000-000N00N435H		CXA1520-0000-000N00N435G		CXA1520-0000-000N00N435F
			P2	1830	2028		CXA1520-0000-000N00P235H		CXA1520-0000-000N00P235G		CXA1520-0000-000N00P235F
	93	95	K4	1290	1484	35H	CXA1520-0000-000N0YK435H	35G	CXA1520-0000-000N0YK435G	35F	CXA1520-0000-000N0YK435F
			M2	1380	1587		CXA1520-0000-000N0YM235H		CXA1520-0000-000N0YM235G		CXA1520-0000-000N0YM235F
3000 K	80	---	N2	1590	1762	30H	CXA1520-0000-000N00N230H	30G	CXA1520-0000-000N00N230G	30F	CXA1520-0000-000N00N230F
			N4	1710	1895		CXA1520-0000-000N00N430H		CXA1520-0000-000N00N430G		CXA1520-0000-000N00N430F
	93	95	K2	1200	1380	30H	CXA1520-0000-000N0YK230H	30G	CXA1520-0000-000N0YK230G	30H	CXA1520-0000-000N0YK230F
			K4	1290	1484		CXA1520-0000-000N0YK430H		CXA1520-0000-000N0YK430G		CXA1520-0000-000N0YK430F
			M2	1380	1587		CXA1520-0000-000N0YM230H		CXA1520-0000-000N0YM230G		CXA1520-0000-000N0YM230F
2700 K	80	---	M4	1485	1645	27H	CXA1520-0000-000N00M427H	27G	CXA1520-0000-000N00M427G	27F	CXA1520-0000-000N00M427F
			N2	1590	1762		CXA1520-0000-000N00N227H		CXA1520-0000-000N00N227G		CXA1520-0000-000N00N227F
			N4	1710	1895		CXA1520-0000-000N00N427H		CXA1520-0000-000N00N427G		CXA1520-0000-000N00N427F
	93	95	J4	1120	1288	27H	CXA1520-0000-000N0YJ427H	27G	CXA1520-0000-000N0YJ427G	27F	CXA1520-0000-000N0YJ427F
			K2	1200	1380		CXA1520-0000-000N0YK227H		CXA1520-0000-000N0YK227G		CXA1520-0000-000N0YK227F

- Notes
- Cree maintains a tolerance of $\pm 7\%$ on flux and power measurements, ± 0.005 on chromaticity (CCx, CCy) measurements and a tolerance of ± 2 on CRI measurements. See the Measurements section (page 15).
 - Cree XLamp CXA1520 LED order codes specify only a minimum flux bin and not a maximum. Cree may ship reels in flux bins higher than the minimum specified by the order code without advance notice. Shipments will always adhere to the chromaticity bin restrictions specified by the order code.
 - * Flux values @ 25 °C are calculated and for reference only.

FLUX CHARACTERISTICS, ANSI WHITE ORDER CODES AND BINS ($I_F = 500 \text{ mA}$, $T_J = 85 \text{ °C}$)

The following table provides order codes for XLamp CXA1520 LEDs. For a complete description of the order code nomenclature, please see the Bin and Order Code Formats section (page 13).

Nominal CCT	CRI		Minimum Luminous Flux			Chromaticity Regions	Order Code
	Min	Typ	Group	Flux (lm) @ 85 °C	Flux (lm) @ 25 °C*		
5000 K	70	75	P2	1830	2028	3A0, 3B0, 3C0, 3D0	CXA1520-0000-000N00P20E3
			P4	1965	2177		CXA1520-0000-000N00P40E3
			Q2	2100	2327		CXA1520-0000-000N00Q20E3
	80	---	N4	1710	1895	3A0, 3B0, 3C0, 3D0	CXA1520-0000-000N0HN40E3
			P2	1830	2028		CXA1520-0000-000N0HP20E3
			P4	1965	2177		CXA1520-0000-000N0HP40E3
4000 K	70	75	N4	1710	1895	5A0, 5B0, 5C0, 5D0	CXA1520-0000-000N00N40E5
			P2	1830	2028		CXA1520-0000-000N00P20E5
			P4	1965	2177		CXA1520-0000-000N00P40E5

- Notes
- Cree maintains a tolerance of $\pm 7\%$ on flux and power measurements, ± 0.005 on chromaticity (CCx, CCy) measurements and a tolerance of ± 2 on CRI measurements. See the Measurements section (page 15).
 - Cree XLamp CXA1520 LED order codes specify only a minimum flux bin and not a maximum. Cree may ship reels in flux bins higher than the minimum specified by the order code without advance notice. Shipments will always adhere to the chromaticity bin restrictions specified by the order code.
 - * Flux values @ 25 °C are calculated and for reference only.

RELATIVE SPECTRAL POWER DISTRIBUTION

The following graph is the result of a series of pulsed measurements at 500 mA and $T_j = 85^\circ\text{C}$.



ELECTRICAL CHARACTERISTICS

The following graph is the result of a series of steady-state measurements.



RELATIVE LUMINOUS FLUX

The relative luminous flux values provided below are the ratio of:

- Measurements of CXA1520 at steady-state operation at the given conditions, divided by
- Flux measured during binning, which is a pulsed measurement at 500 mA at $T_j = 85^\circ\text{C}$.

For example, at steady-state operation of $T_c = 105^\circ\text{C}$, $I_f = 700\text{ mA}$, the relative luminous flux ratio is 120% in the chart below. A CXA1520 LED that measures 2100 lm during binning will deliver 2520 lm (2100×1.2) at steady-state operation of $T_c = 105^\circ\text{C}$, $I_f = 700\text{ mA}$.

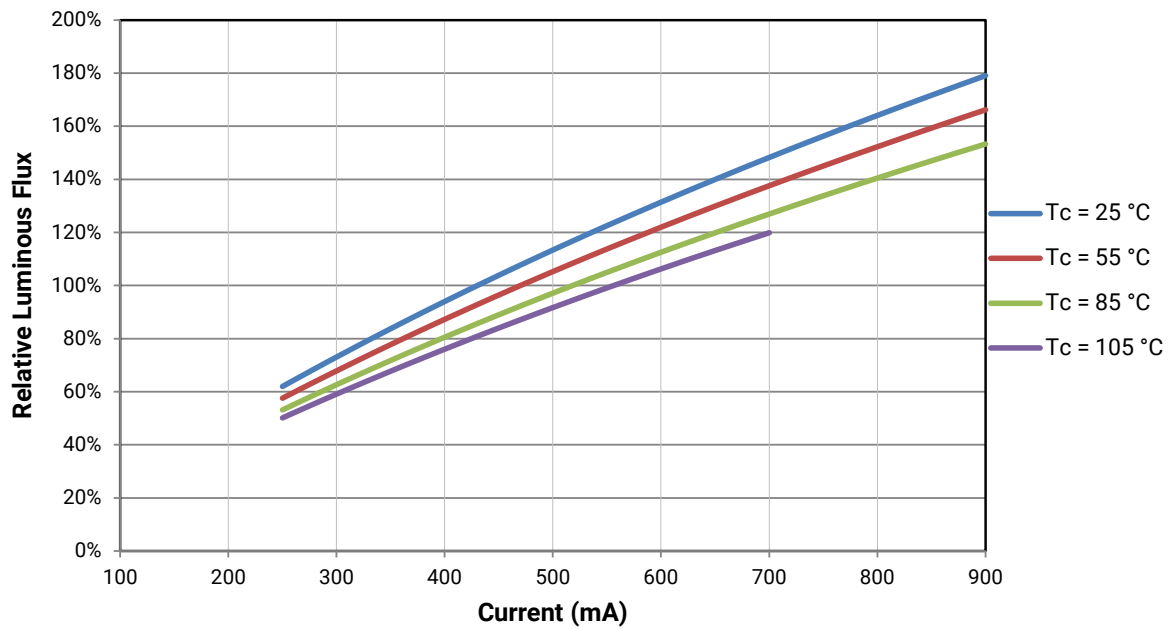

TYPICAL SPATIAL DISTRIBUTION

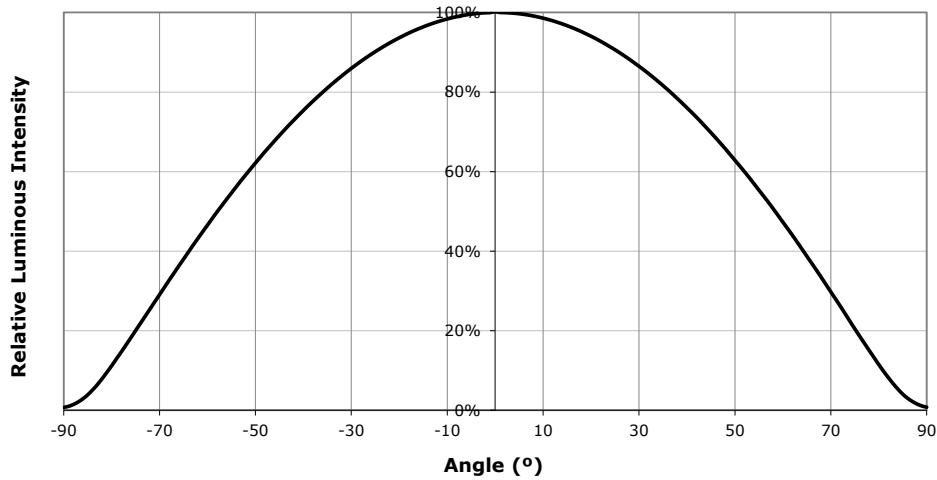

PERFORMANCE GROUPS - BRIGHTNESS ($I_F = 500 \text{ mA}$, $T_J = 85 \text{ °C}$)

XLamp CXA1520 LEDs are tested for luminous flux and placed into one of the following bins.

Group Code	Min. Luminous Flux	Max. Luminous Flux
J2	1040	1120
J4	1120	1200
K2	1200	1290
K4	1290	1380
M2	1380	1485
M4	1485	1590
N2	1590	1710
N4	1710	1830
P2	1830	1965
P4	1965	2100
Q2	2100	2260
Q4	2260	2420

PERFORMANCE GROUPS - CHROMATICITY ($T_j = 85\text{ }^\circ\text{C}$)

XLamp CXA1520 LEDs are tested for chromaticity and placed into one of the regions defined by the following bounding coordinates.

EasyWhite Color Temperatures – 2-Step			
Code	CCT	x	y
50H	5000 K	0.3429	0.3507
		0.3434	0.3571
		0.3475	0.3604
		0.3469	0.3539
40H	4000 K	0.3784	0.3741
		0.3804	0.3818
		0.3867	0.3857
		0.3844	0.3778
35H	3500 K	0.4030	0.3857
		0.4061	0.3941
		0.4132	0.3976
		0.4099	0.3890
30H	3000 K	0.4291	0.3973
		0.4333	0.4062
		0.4395	0.4084
		0.4351	0.3994
27H	2700 K	0.4528	0.4046
		0.4578	0.4138
		0.4638	0.4152
		0.4586	0.4060

EasyWhite Color Temperatures – 3-Step Ellipse						
Bin Code	CCT	Center Point		Major Axis	Minor Axis	Rotation Angle (°)
		x	y	a	b	
50G	5000 K	0.3447	0.3553	0.00840	0.00312	65.0
40G	4000 K	0.3818	0.3797	0.00939	0.00402	53.7
35G	3500 K	0.4073	0.3917	0.00927	0.00414	54.0
30G	3000 K	0.4338	0.4030	0.00834	0.00408	53.2
27G	2700 K	0.4577	0.4099	0.00834	0.00420	48.5

PERFORMANCE GROUPS - CHROMATICITY (T_j = 85 °C) - CONTINUED

EasyWhite Color Temperatures – 4-Step			
Code	CCT	x	y
50F	5000 K	0.3407	0.3459
		0.3415	0.3586
		0.3499	0.3654
		0.3484	0.3521
40F	4000 K	0.3744	0.3685
		0.3782	0.3837
		0.3912	0.3917
		0.3863	0.3758
35F	3500 K	0.3981	0.3800
		0.4040	0.3966
		0.4186	0.4037
		0.4116	0.3865
30F	3000 K	0.4242	0.3919
		0.4322	0.4096
		0.4449	0.4141
		0.4359	0.3960
27F	2700 K	0.4475	0.3994
		0.4573	0.4178
		0.4695	0.4207
		0.4589	0.4021

ANSI White Bins				
Code	CCT	Bin Code	x	y
0E3	5000 K	3A0	.3371	.3490
			.3451	.3554
			.3440	.3427
			.3366	.3369
		3B0	.3376	.3616
			.3463	.3687
			.3451	.3554
			.3371	.3490
		3C0	.3463	.3687
			.3551	.3760
			.3533	.3620
			.3451	.3554
		3D0	.3451	.3554
			.3533	.3620
			.3515	.3487
			.3440	.3427

ANSI White Bins				
Code	CCT	Bin Code	x	y
0E5	4000 K	5A0	.3670	.3578
			.3702	.3722
			.3825	.3798
			.3783	.3646
		5B0	.3702	.3722
			.3736	.3874
			.3869	.3958
			.3825	.3798
		5C0	.3825	.3798
			.3869	.3958
			.4006	.4044
			.3950	.3875
		5D0	.3783	.3646
			.3825	.3798
			.3950	.3875
			.3898	.3716

CREE EASYWHITE® BINS PLOTTED ON THE 1931 CIE COLOR SPACE ($T_j = 85\text{ }^\circ\text{C}$)



CREE ANSI WHITE BINS PLOTTED ON THE 1931 CIE COLOR SPACE ($T_j = 85^\circ\text{C}$)

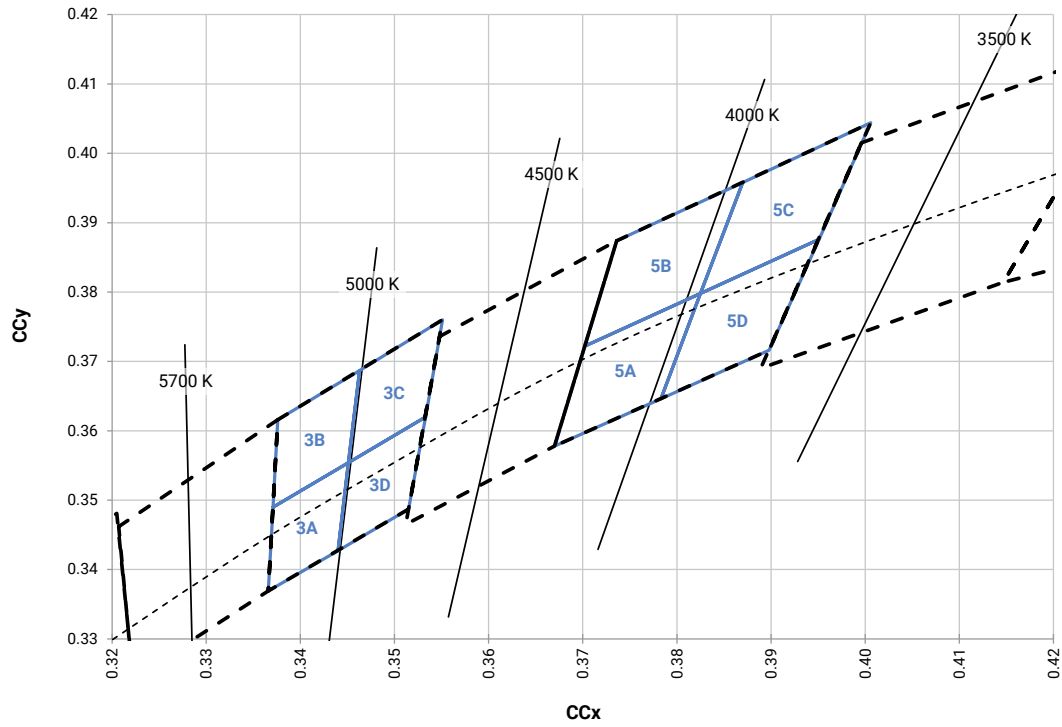

BIN AND ORDER CODE FORMATS

Bin codes and order codes are configured as follows:



MECHANICAL DIMENSIONS

Dimensions are in mm.
 Tolerances unless otherwise specified: ± 0.13
 $\alpha^\circ \pm 1^\circ$



THERMAL DESIGN

The CXA family of LED arrays can include over a hundred different LED die inside one package, and thus over a hundred different junction temperatures (T_j). Cree has intentionally removed junction-temperature-based operating limits and replaced the commonplace maximum T_j calculations with maximum ratings based on forward current (I_f) and case temperature (T_c). No additional calculations are required to ensure the CXA LED is being operated within its designed limits. Please refer to page 2 for the Operating Limit specification.

There is no need to calculate for T_j inside the package, as the thermal management design process, specifically from solder point (T_{sp}) to ambient (T_a), remains identical to any other LED component. For more information on thermal management of Cree XLamp LEDs, please refer to the [Thermal Management application note](#). For CXA soldering recommendations and more information on thermal interface materials (TIM) and connection methods, please refer to the [Cree XLamp CX Family LEDs soldering and handling document](#). The [CX Family LED Design Guide](#) provides basic information on the requirements to use Cree XLamp CXA LEDs successfully in luminaire designs.

To keep the CXA1520 LED at or below the maximum rated T_c , the case to ambient temperature thermal resistance (R_{c-a}) must be at or below the maximum R_{c-a} value shown on the following graph, depending on the operating environment. The y-axis in the graph is a base 10 logarithmic scale.

As the figure at right shows, the R_{c-a} value is the sum of the thermal resistance of the TIM (R_{tim}) plus the thermal resistance of the heat sink (R_{hs}).

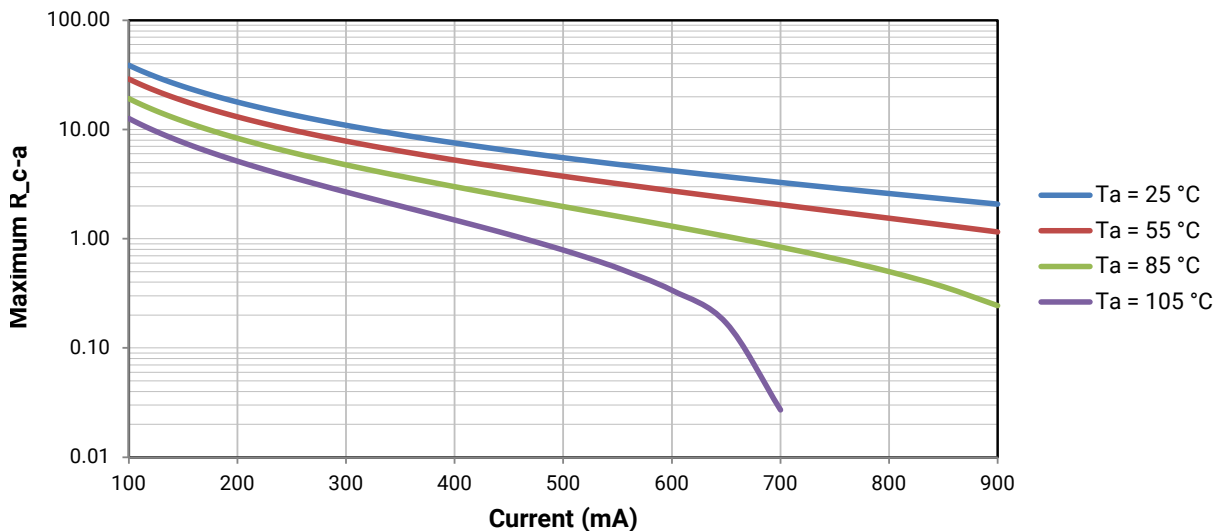
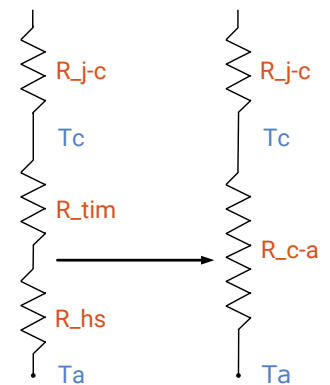

NOTES

Measurements

The luminous flux, radiant power, chromaticity and CRI measurements in this document are binning specifications only and solely represent product measurements as of the date of shipment. These measurements will change over time based on a number of factors that are not within Cree's control and are not intended or provided as operational specifications for the products. Calculated values are provided for informational purposes only and are not intended as specifications.

Lumen Maintenance

Cree now uses standardized IES LM-80-08 and TM-21-11 methods for collecting long-term data and extrapolating LED lumen maintenance. For information on the specific LM-80 data sets available for this LED, refer to the public [LM-80 results document](#).

Please read the [Long-Term Lumen Maintenance application note](#) for more details on Cree's lumen maintenance testing and forecasting. Please read the [Thermal Management application note](#) for details on how thermal design, ambient temperature, and drive current affect the LED junction temperature.

RoHS Compliance

The levels of RoHS restricted materials in this product are below the maximum concentration values (also referred to as the threshold limits) permitted for such substances, or are used in an exempted application, in accordance with EU Directive 2011/65/EC (RoHS2), as implemented January 2, 2013. RoHS Declarations for this product can be obtained from your Cree representative or from the Product Documentation sections of www.cree.com.

REACH Compliance

REACH substances of very high concern (SVHCs) information is available for this product. Since the European Chemical Agency (ECHA) has published notice of their intent to frequently revise the SVHC listing for the foreseeable future, please contact a Cree representative to insure you get the most up-to-date REACH Declaration. REACH banned substance information (REACH Article 67) is also available upon request.

UL® Recognized Component

Level 4 enclosure consideration. The LED package or a portion thereof has been investigated as a fire and electrical enclosure per ANSI/UL 8750.

Vision Advisory

WARNING: Do not look at an exposed lamp in operation. Eye injury can result. For more information about LEDs and eye safety, please refer to the [LED Eye Safety application note](#).

PACKAGING

Cree CXA1520 LEDs are packaged in trays of 20. Five trays are sealed in an anti-static bag and placed inside a carton, for a total of 100 LEDs per carton. Each carton contains 100 LEDs from the same performance bin.

Dimensions are in inches.
Tolerances: $\pm .13$
 $x^\circ \pm 1^\circ$

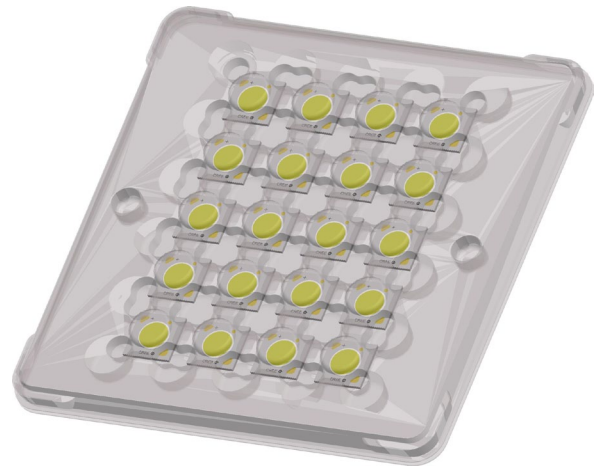
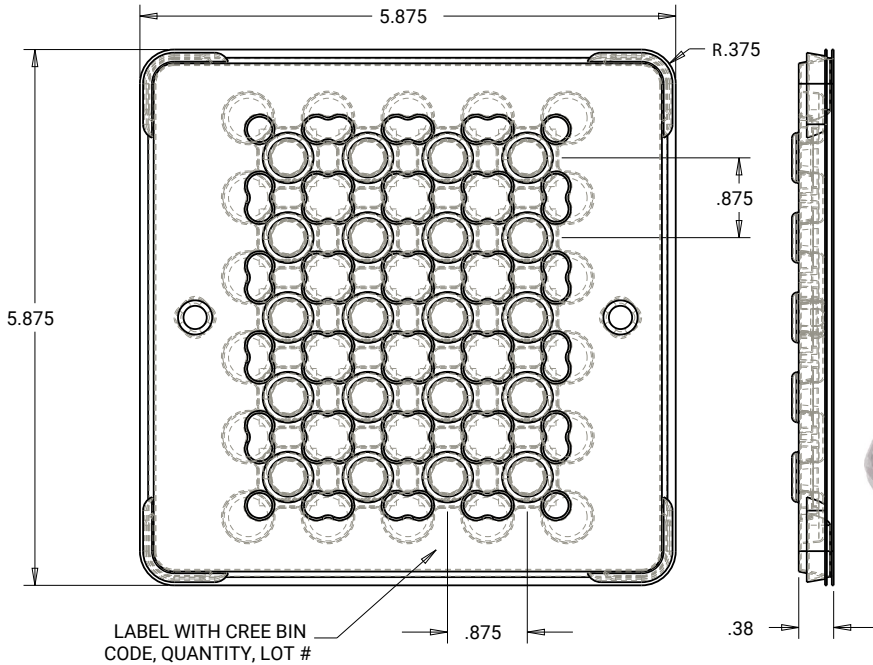

PATENT LABEL IS LOCATED ON UNDERSIDE OF CARTON

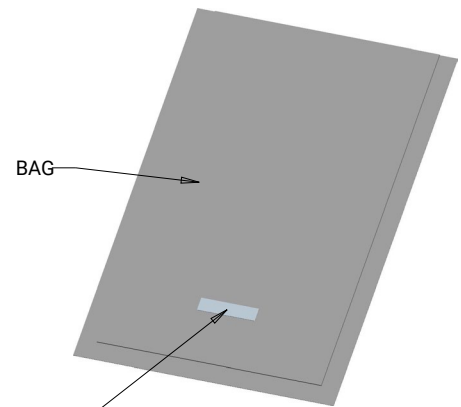
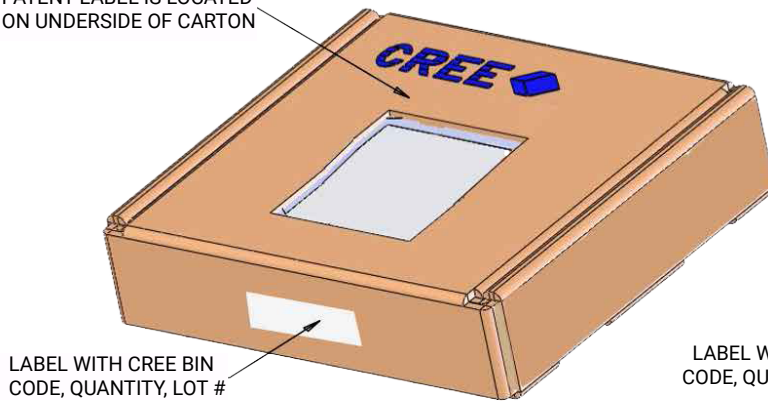



Компания «ЭлектроПласт» предлагает заключение долгосрочных отношений при поставках импортных электронных компонентов на взаимовыгодных условиях!

Наши преимущества:

- Оперативные поставки широкого спектра электронных компонентов отечественного и импортного производства напрямую от производителей и с крупнейших мировых складов;
- Поставка более 17-ти миллионов наименований электронных компонентов;
- Поставка сложных, дефицитных, либо снятых с производства позиций;
- Оперативные сроки поставки под заказ (от 5 рабочих дней);
- Экспресс доставка в любую точку России;
- Техническая поддержка проекта, помощь в подборе аналогов, поставка прототипов;
- Система менеджмента качества сертифицирована по Международному стандарту ISO 9001;
- Лицензия ФСБ на осуществление работ с использованием сведений, составляющих государственную тайну;
- Поставка специализированных компонентов (Xilinx, Altera, Analog Devices, Intersil, Interpoint, Microsemi, Aeroflex, Peregrine, Syfer, Eurofarad, Texas Instrument, Miteq, Cobham, E2V, MA-COM, Hittite, Mini-Circuits, General Dynamics и др.);

Помимо этого, одним из направлений компании «ЭлектроПласт» является направление «Источники питания». Мы предлагаем Вам помощь Конструкторского отдела:

- Подбор оптимального решения, техническое обоснование при выборе компонента;
- Подбор аналогов;
- Консультации по применению компонента;
- Поставка образцов и прототипов;
- Техническая поддержка проекта;
- Защита от снятия компонента с производства.



Как с нами связаться

Телефон: 8 (812) 309 58 32 (многоканальный)

Факс: 8 (812) 320-02-42

Электронная почта: org@eplast1.ru

Адрес: 198099, г. Санкт-Петербург, ул. Калинина, дом 2, корпус 4, литера А.