

## Features

- Digital angular rate sensor with SPI interface
- Angular rate measurement around Z-axis (yaw)
- $\pm 300^\circ/\text{sec}$  input range
- Ultra low noise
- Excellent bias instability
- 24 bit angular rate output
- Embedded temperature sensor for on-chip or external temperature compensation
- Built-in Self-Test
- 5V single supply voltage
- Low operating current consumption: 25mA
- CLCC 30 package: 19.6 mm x 11.5 mm x 2.9 mm
- Weight : 2 grams
- REACH and RoHS compatible



## General Description

GYPRO® product line is a new generation of Micro-Electro-Mechanical Systems (MEMS) angular rate sensor specifically designed for demanding applications.

The MEMS transducer is manufactured using Tronics proprietary vacuum wafer-level packaging technology based on micro-machined thick single crystal silicon.

The integrated circuit (IC) provides a stable primary anti-phase vibration of the 'drive' proof masses, thanks to electrostatic comb drives. When the sensor is subjected to a rotation, the Coriolis force acts on the 'sense' proof masses and forces them into a secondary anti-phase movement perpendicular to the direction of drive vibration, which is itself counter-balanced by electrostatic forces. The sense closed loop operates as an electromechanical  $\Sigma\Delta$  modulator providing a digital output. This output is finally demodulated using the drive reference signal.

The sensor is factory calibrated and compensated for temperature effects to provide high-accuracy digital output over a broad temperature range.

Raw data output can be also chosen to enable customer-made compensations.

## Applications

- Precision instrumentation
- Platform stabilization and control
- Unmanned aerial vehicles

## GYPRO® Product references

	Description	Vibration range	Bandwidth	Latency	Temperature range
<b>GYPRO2300</b>	Standard configuration	4 grms	100Hz	40 ms	-40°C to +85°C
<b>GYPRO2300LD</b>	Low delay configuration	4 grms	>200Hz	2 ms	-40°C to +85°C
<b>GYPRO3300</b>	Improved vibration tolerance & Ultra low delay configuration	8 grms	>200Hz	1 ms	-40°C to +85°C

## Disclaimer

*Information furnished by Tronics is believed to be accurate and reliable. However, no responsibility is assumed by Tronics for its use, nor for any infringements of patents or other rights of third parties that may result from its use.*

*Specification subject to change without notice.*

*No license is granted by implication or otherwise under any patent or patent rights of Tronics. Trademarks and registered trademarks are the property of their respective owners.*

## Contents

<b>Features .....</b>	<b>1</b>
<b>Applications.....</b>	<b>1</b>
<b>General Description .....</b>	<b>1</b>
<b>GYPRO® Product references .....</b>	<b>1</b>
<b>Disclaimer.....</b>	<b>1</b>
Block diagram .....	3
Overall Dimensions.....	3
<b>1. Specifications .....</b>	<b>4</b>
<b>2. Maximum Ratings .....</b>	<b>6</b>
<b>3. Typical performances .....</b>	<b>7</b>
<b>4. Interface .....</b>	<b>9</b>
4.1. Pinout, sensitive axis identification .....	9
4.2. Application circuit.....	9
4.3. Input/Output Pin Definitions .....	10
<b>5. Soldering Recommendations .....</b>	<b>11</b>
<b>6. Digital SPI interface .....</b>	<b>12</b>
6.1. Electrical and Timing Characteristics .....	12
6.2. SPI frames description .....	13
6.3. Angular rate readings .....	13
6.4. Temperature readings.....	13
6.5. Advanced use of SPI registers.....	14
<b>7. Angular rate calibration procedure .....</b>	<b>16</b>
7.1. Algorithm overview .....	16
7.2. Programming of the new coefficients .....	17
7.3. Switch to uncompensated data output.....	17
<b>8. Temperature Sensor Calibration Procedure .....</b>	<b>18</b>
8.1. Temperature sensor calibration model.....	18
8.2. Recommended Procedure.....	18
<b>9. Device Identification/Ordering information .....</b>	<b>19</b>
9.1. Device identification.....	19
9.2. Ordering information .....	19
<b>10. Internal construction and Theory of Operation .....</b>	<b>20</b>
<b>11. Available Tools and Resources.....</b>	<b>21</b>

Block diagram

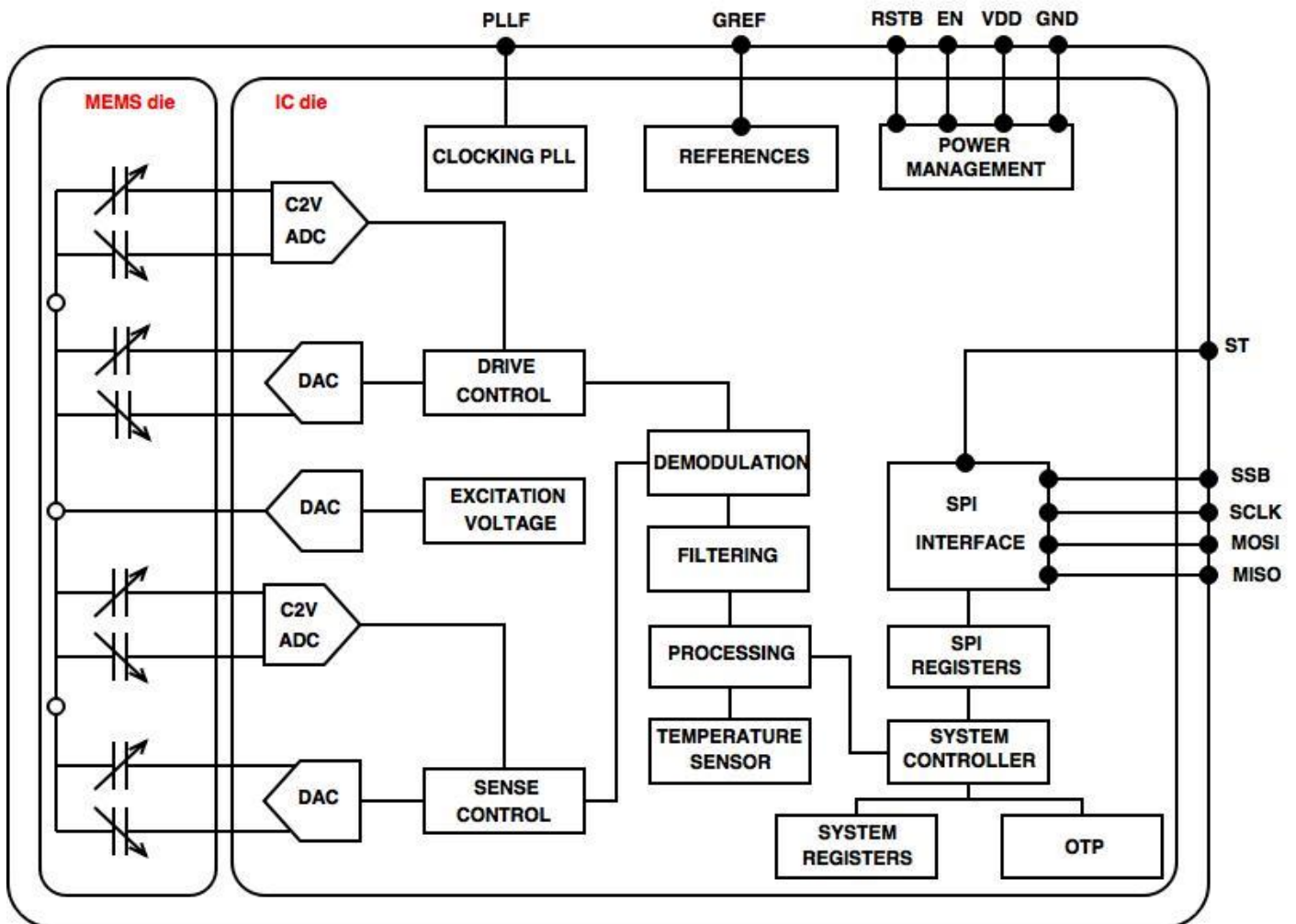

Overall Dimensions

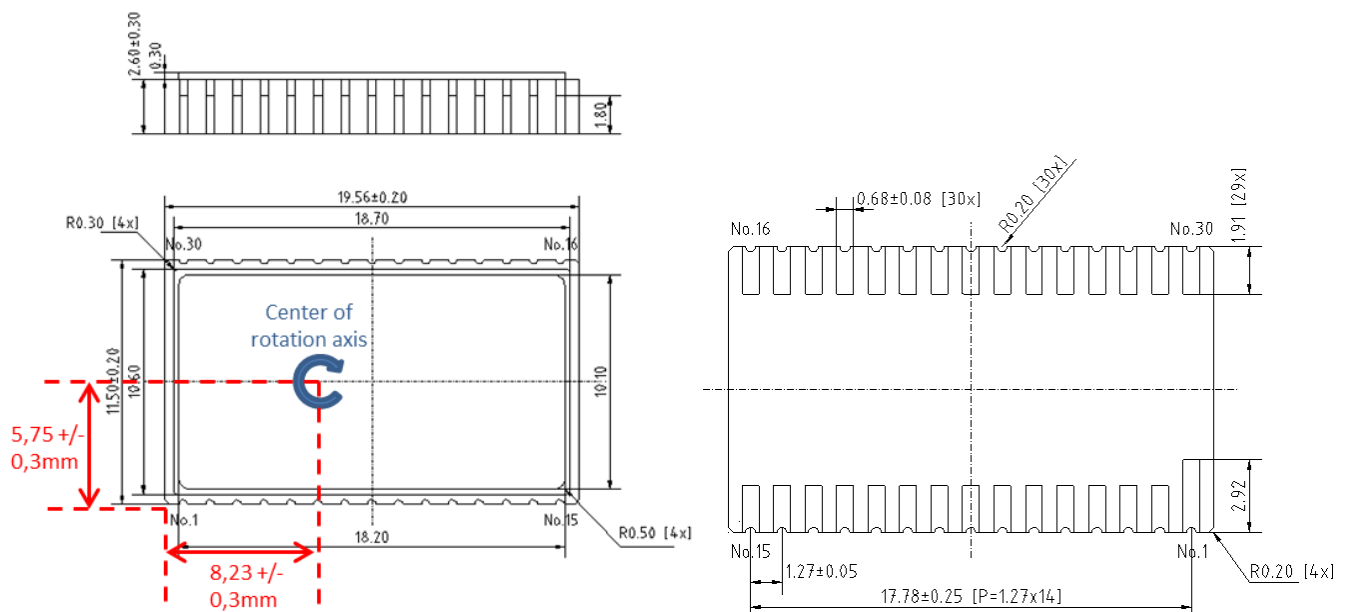

### 1. Specifications

Unless specified in brackets, GYPRO2300LD characteristics are the same as GYPRO2300.

Parameter	Unit	Typ.	Max	Notes
<b>Measurement Ranges</b>				
Input range*	°/s	±300	±600	
Temperature range *	°C	-40 to +85		
<b>Bias</b>				
Bias instability	°/h	0.8		Lowest point of Allan variance curve at room temperature.
Bias in-run (short term) stability	°/h	30		Standard deviation of the 1 second filtered output over 1 hour at room temperature, after 30 min of stabilization.
Bias temperature variations, calibrated *	°/s	0.05	0.2	Peak to peak deviation of the bias over the specified temperature range. Factory calibration is performed in test socket. As printed circuit board reflow soldering may cause shifts in bias temperature variations, it may be necessary to do an on-board calibration after soldering, depending on applications requirements.
Bias run to run repeatability	°/h	10		Standard deviation of 7 bias measurements at 30°C that occurs between seven runs of operation with 30 minutes power off between each run.
Vibration rectification coefficient	°/h/g <sup>2</sup>	10		Bias rectification under vibration, overall level 4g rms.
<b>Scale Factor</b>				
Scale Factor *	LSB/°/s	10 000		Nominal scale factor.
Scale Factor temperature variations, calibrated *	%	0.2	0.5	Peak to peak deviation of the scale factor over the specified temperature range.
Scale Factor run to run repeatability	ppm	450		Standard deviation of 7 scale factor measurements at 30°C that occurs between seven runs of operation with 30 minutes power off between each run.
Scale factor non linearity*	ppm	70	500	Maximum deviation of the output from the expected value using a best fit straight line, at room temperature.
<b>Noise</b>				
RMS Noise [1-100Hz] *	°/s	0.02	0.05	RMS noise level in the band [1-100Hz], obtained by integrating the power spectral density of the sensor output between 1 and 100Hz at zero rate and room temperature.
Angular random walk	°/√h	0.14		-1/2 slope of Allan variance curve at room temperature.
<b>Frequency response</b>				
Bandwidth	Hz	100 (>200)		Defined as the frequency for which attenuation is equal to -3dB.
Data Rate	Hz	190 to 230 (1560 to 1780)		Refresh rate of the output data at room temperature.
Latency	ms	40 (2)		Group delay of the filtering chain.

Parameter	Unit	Typ.	Max	Notes
Start-up Time	s	0.8		Time interval between application of power on and the availability of an output signal (at least 90% of the input rate, at room temperature).
<b>Linear acceleration</b>				
G sensitivity	°/h/g	18		Mean value on all axis of output variations under 1g.
Recovery time	ms	10		Time interval between an impact (half sine 50 g, 6 ms) and the presence of a usable output of the sensor.
<b>Axis alignment</b>				
Rate Axis misalignment	mrad		16	Misalignment between the sensitive axis and the normal to the package bottom plane, by design.
<b>Environmental</b>				
Storage temperature range	°C	-55 to +100		
Humidity at 45°C	%	<98		
Moisture Sensitivity Level (MSL)	--	1		Unlimited floor life out of the bag (hermetic package).
Shock (operating)	g   ms	50   6		Half sine.
Shock (survival)	g   ms	2000   0.3		
Vibrations (operating)	g <sub>rms</sub>	4		See Figure 11
Vibrations (survival)	g <sub>rms</sub>	20		
<b>Electrical</b>				
Power Supply Voltage	V	4.75 to 5.25		
Current consumption (normal mode)	mA	25		
Current consumption (power down mode)	µA	1	<5	Power down mode is activated by switching EN pin to GND.
Power supply rejection ratio	°/h/V	40		
<b>Temperature sensor</b>				
Scale Factor (raw data)	LSB/°C	20		Temperature sensor is not factory-calibrated.
25°C typical output (raw data)	LSB	2000		Temperature sensor is not factory-calibrated.
Refresh rate	Hz	6		

**Table 1 Specifications**

\* 100% tested in production.

\*\* Unless otherwise specified, max values are ±3 sigma variation limits from validation test population.

## 2. Maximum Ratings

Stresses higher than the maximum ratings listed below may cause permanent damage to the device, or affect its reliability. Functional operation is not guaranteed once stresses higher than the maximum ratings have been applied.

Exposure to maximum ratings conditions for extended periods may also affect device reliability.

Parameter	Unit	Min	Max
Supply Voltage	V	-0.5	+7
Electrostatic Discharge (ESD) protection, any pin, Human Body Model	kV	--	±2
Storage temperature range	°C	-55	+100
Shock survival	g	--	2000
Vibrations survival, 20-2000Hz	g <sub>rms</sub>	--	20
Ultrasonic cleaning		Not allowed	

Table 2 Maximum ratings

### Caution!



The product may be damaged by ESD, which can cause performance degradation or device failure! We recommend handling the device only on a static safe work station. Precaution for the storage should also be taken.



The sensor **MUST** be powered-on *before* any SPI operation, as shown in Figure 1 below. Having the SPI pads, or EN at a high level while VDD is at a low level could damage the sensor, due to ESD protection diodes and buffers.

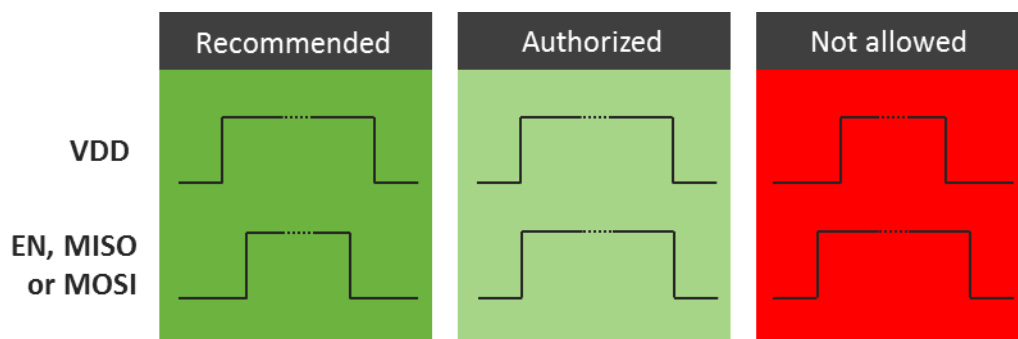

Figure 1 Recommended voltage sequence

### 3. Typical performances

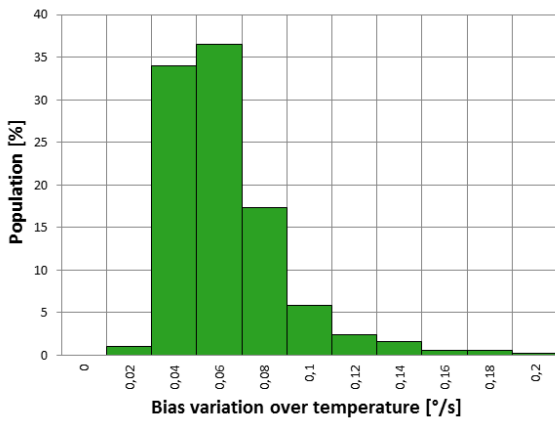

Figure 2 Distribution of bias over temperature

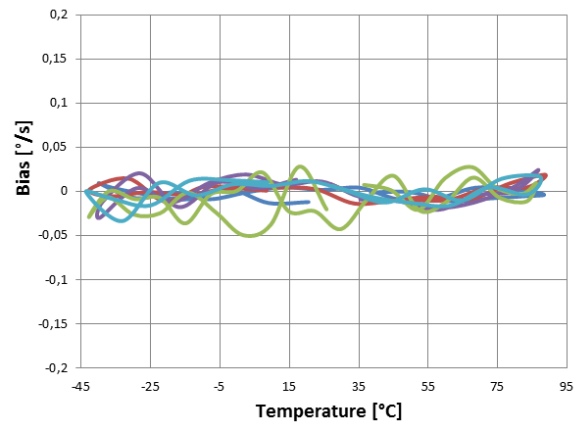

Figure 5 Bias variation over temperature (5 samples)

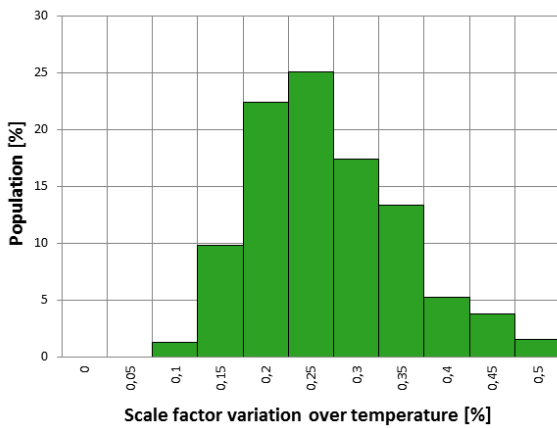

Figure 3 Distribution of scale factor over temperature

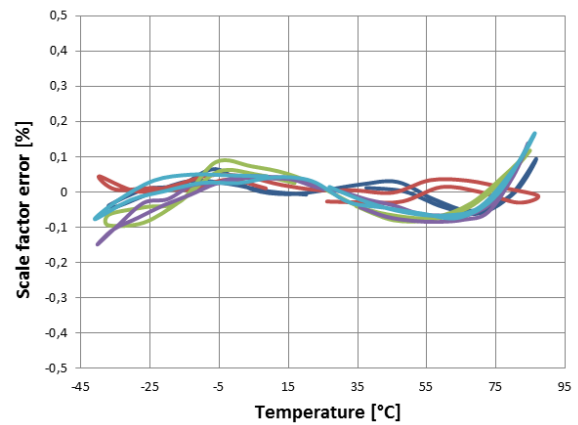

Figure 6 Scale factor variation over temperature (5 samples)

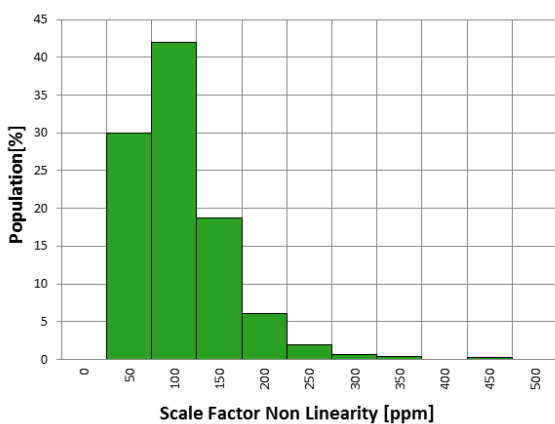

Figure 4 Distribution of scale factor non linearity (RT)

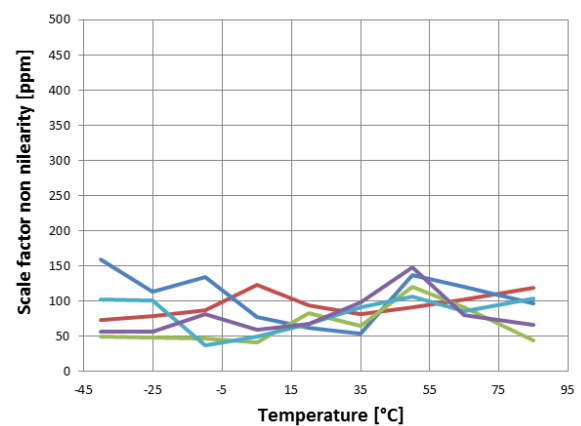

Figure 7 Scale factor non linearity over temperature (5 samples)

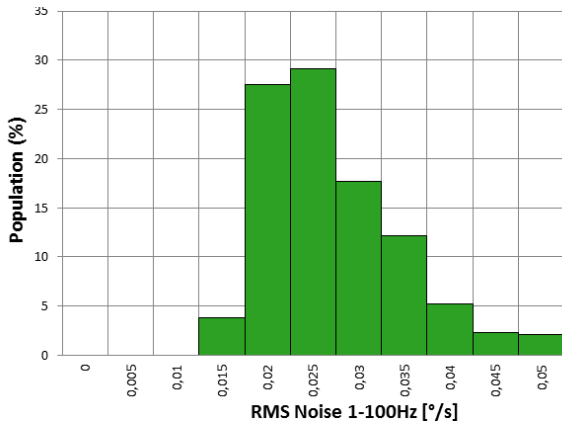

Figure 8 Distribution of RMS Noise (RT)

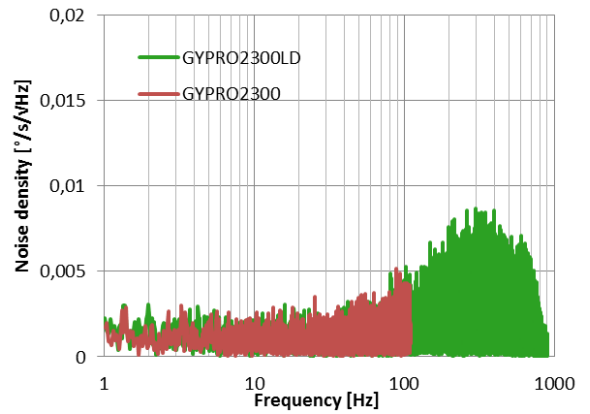

Figure 12 Typical Noise density (RT)

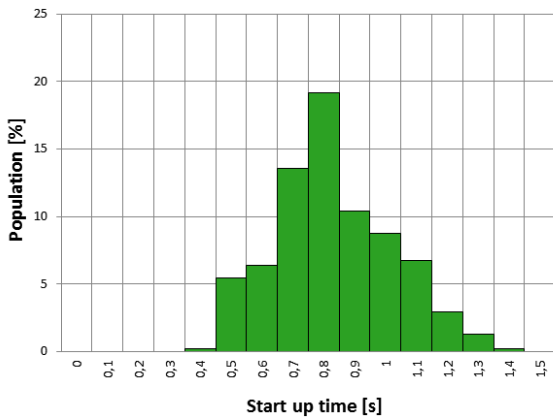

Figure 9 Distribution of Start-Up time (RT)

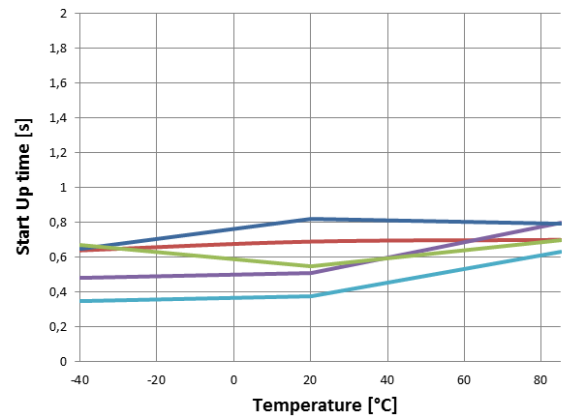

Figure 13 Start-Up Time variation over temperature

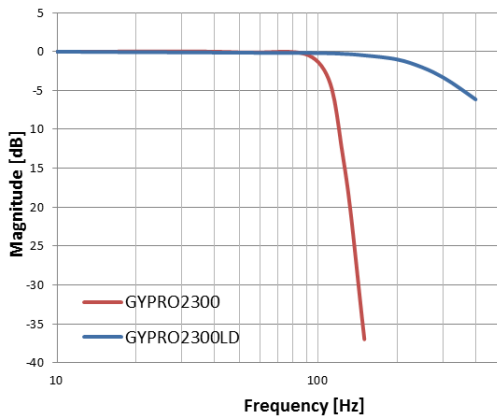

Figure 10 Typical Bandwidth

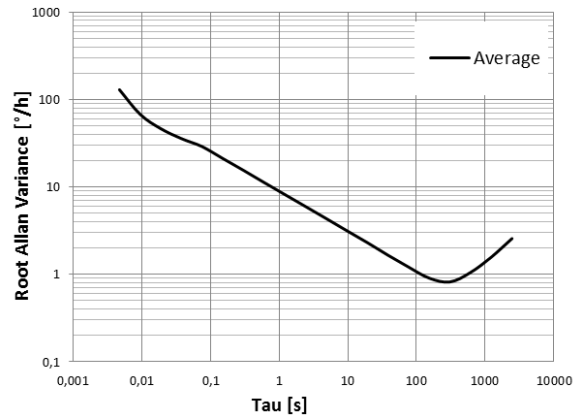

Figure 14 Allan variance (RT)

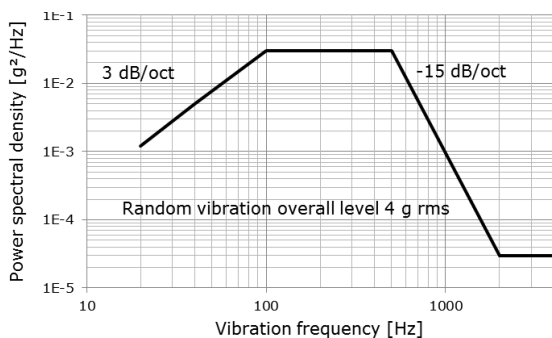

Figure 11 Operating vibration profile



## 4. Interface

### 4.1. Pinout, sensitive axis identification

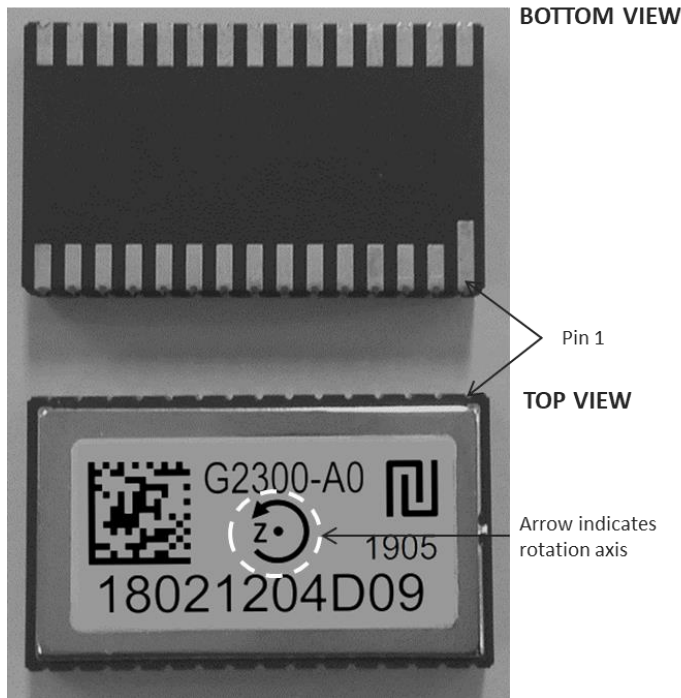

Figure 15: How to locate Pin 1

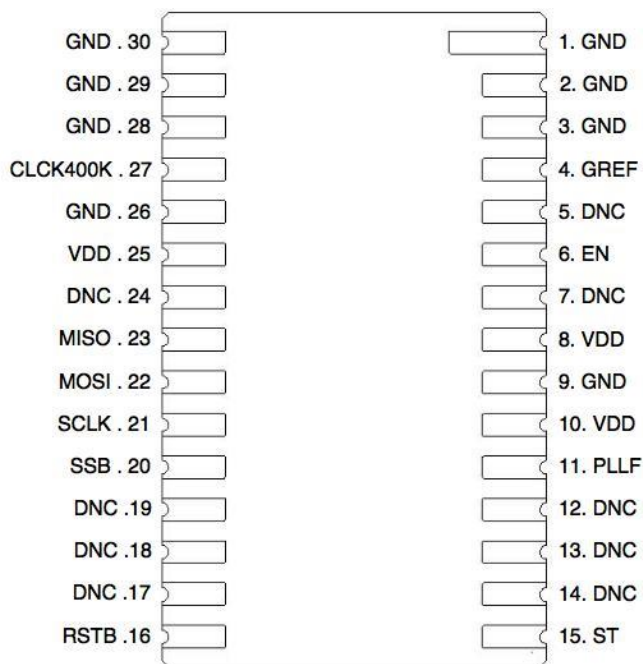

Figure 16: GYPRO2300 Sensors Pinout (bottom view)

### 4.2. Application circuit

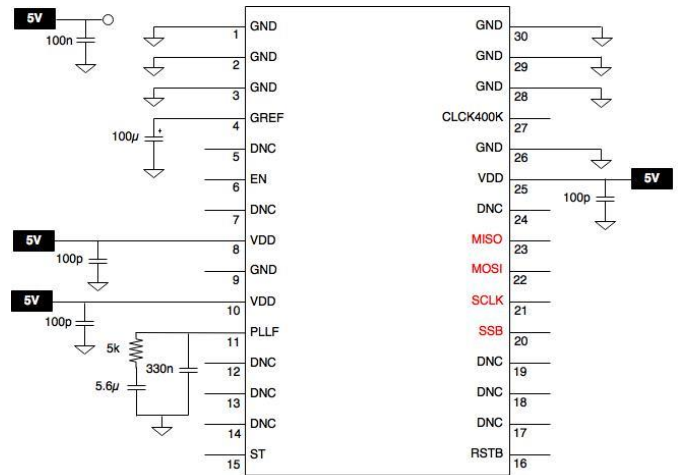

Figure 17: Recommended Application Schematic (top view)

Notes:

- All capacitances of Figure 17 should be placed as close as possible to their corresponding pins, except the 100nF capacitance between VDD and GND, which should be as close as possible to the board's supply input.
- The 100µF filtering capacitance between GREF and GND should have low Equivalent Series Resistance (ESR < 1Ω) and low leakage current (< 6µA). A tantalum capacitor is recommended.
- 5.6µF and 330nF filtering capacitance between PLLF and GND should have a low leakage current (<1µA).

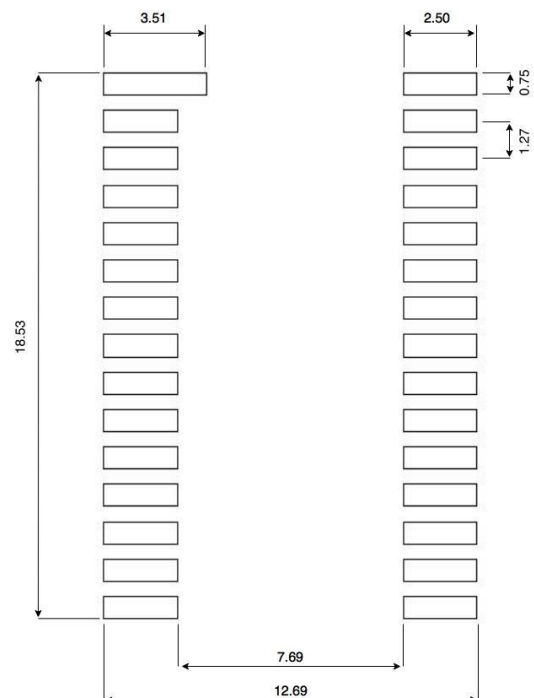

Figure 18: Recommended Pad Layout in mm (top view)

### 4.3. Input/Output Pin Definitions

Pin name	Pin number	Pin type	Pin direction	Pin levels	Function
<b>GND</b>	1, 2, 3, 9, 26, 28, 29, 30	Supply	n/a	0V	Power Ground
<b>VDD</b>	8, 10, 25	Supply	n/a	+5V	Power Supply
<b>GREF</b>	4	Analog	n/a	4.4V	External decoupling pad. MUST be connected to the board's VSS through a 100µF external capacitor, in order to ensure low noise.
<b>EN</b>	6	Digital	Input	VDD with pull-up of 100kΩ	Enable command. Active high.
<b>PLLF</b>	11	Analog	Output	0.8V	External filtering pad. MUST be connected to a filtering stage, described in Figure 17.
<b>ST</b>	15	Digital	Output	VDD	Self-test status. Logic "1" when the sensor is OK.
<b>RSTB</b>	16	Digital	Input	VDD with pull-up of 100kΩ	Reset. Reloads the internal calibration data. Active low
<b>SSB</b>	20	Digital	Input	VDD	Slave Selection signal. Active low
<b>SCLK</b>	21	Digital	Input	VDD	SPI clock signal
<b>MOSI</b>	22	Digital	Input	VDD	Master Output Slave Input signal
<b>MISO</b>	23	Digital	Output	VDD	Master Input Slave Output signal
<b>CLCK400K</b>	27	Digital	Output	VDD	Internal clock
<b>DNC</b>	5, 7, 12, 13, 14, 17, 18, 19, 24	--	--	--	Do Not electrically Connect. These pins provide additional mechanical fixing to the board and should be soldered to an unconnected pad.

**Table 3: Pin Functions**

Note: The digital pads maximum ratings are GND-0.3V and VDD+0.3V.

## 5. Recommendations

### 5.1. Soldering

Please note that the reflow profile to be used does not depend only on the sensor. The whole populated board characteristics shall be taken into account.

MEMS components are sensitive to mechanical stress coming from the Printed Circuit Board (PCB) during the soldering reflow. This stress is caused by the mismatch between the Coefficient of Thermal Expansion (CTE) of the ceramic package and the PCB and can affect the Bias temperature variations. In order to achieve the best performance, it is recommended to do an on-board calibration after the soldering of the sensor.

For a better reliability of the soldering, Tronics recommends using Copper-Invar-Copper or ceramic boards. These types of boards have a coefficient of thermal expansion (CTE) close to the CTE of GYPRO2300 package (6.8 ppm/°C).

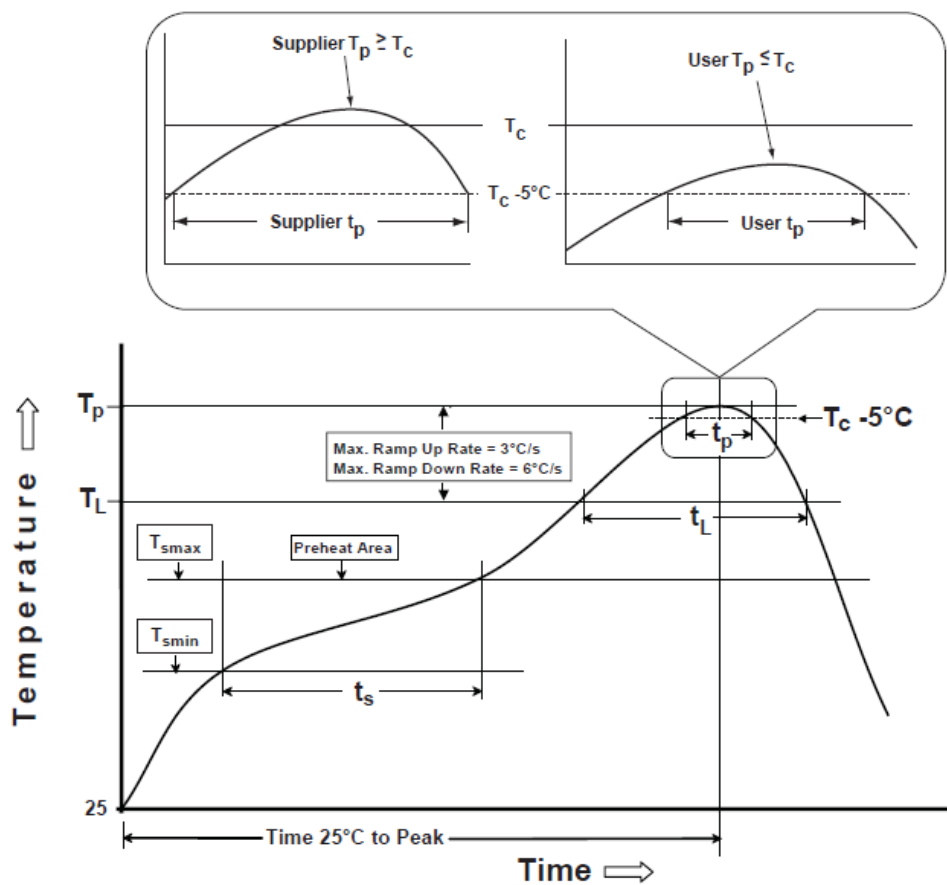

Figure 19: Reflow Profile, according to IPC/JEDEC J-STD-020D.1

Profile Feature	Eutectic Assembly
<b>Time maintained above</b>	
Temperature ( $T_L$ )	183°C
Time ( $t_L$ )	60-150 sec
Peak Temperature ( $T_p$ )	240°C (+/-5°C)
Time within 5°C of Actual Peak Temperature ( $t_p$ )	10-30 sec

Table 4: Reflow Profile Details, according to IPC/JEDEC J-STD-020D.1

### 5.2. Multi-sensor integration

Mechanical coupling between drive frequencies of several sensors can affect performance at system level, for example within Inertial Measurement Units. Customer has to take care of such coupling during system design and validation.

## 6. Digital SPI interface

### 6.1. Electrical and Timing Characteristics

The device acts as a slave supporting only SPI “mode 0” (clock polarity CPOL=0, clock phase CPHA=0).

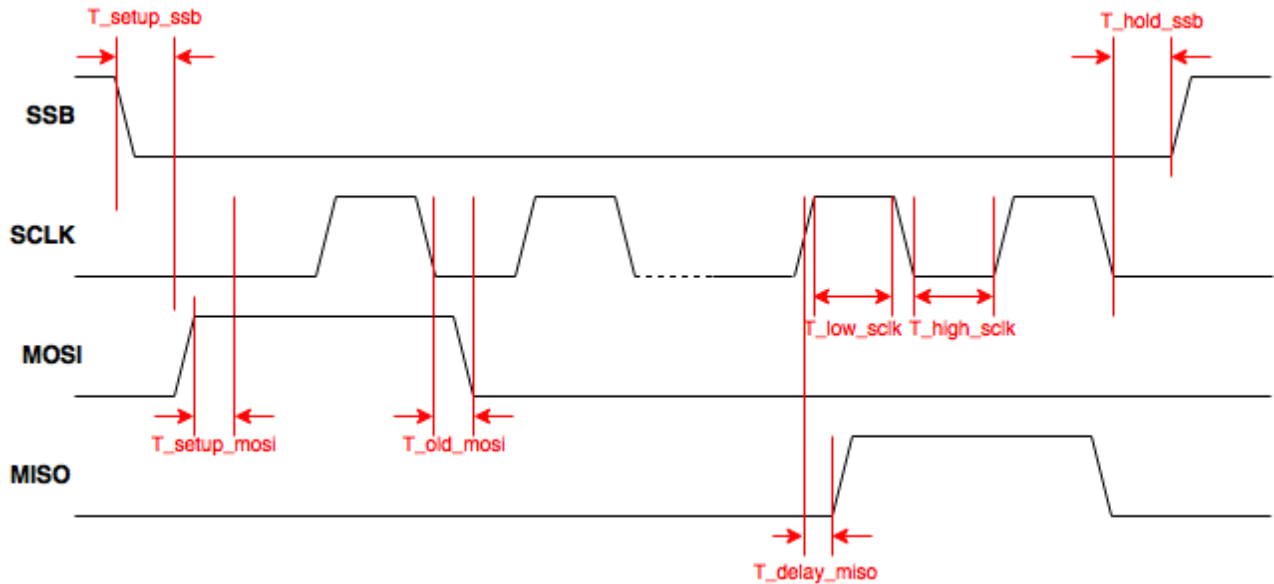

Figure 20: SPI timing diagram

Symbol	Parameter	Condition	Unit	Min	Typ	Max
<b>Electrical characteristics</b>						
VIL	Low level input voltage		VDD	0		0.1
VIH	High level input voltage		VDD	0.8		1
VOL	Low level output voltage	ioL=0mA (Capacitive Load)	V		GND	
VOH	High level output voltage	ioH=0mA (Capacitive Load)	V		VDD	
Rpull_up	Pull-up resistor	Internal pull-up resistance to VDD	kΩ		100	
Rpull_down	Pull-down resistor	Internal pull-down resistance to GND	kΩ		-	
<b>Timing parameters</b>						
Fspi	SPI clock input frequency	Maximal load 25pF on MOSI or MISO	MHz		0.2	8
T_low_sclk	SCLK low pulse		ns	62.5		
T_high_sclk	SCLK high pulse		ns	62.5		
T_setup_mosi	MOSI setup time		ns	10		
T_hold_mosi	MOSI hold time		ns	5		
T_delay_miso	MISO output delay	Load 25pF	ns			40
T_setup_ssb	SSB setup time		Tsclk	1		
T_hold_ssb	SSB hold time		Tsclk	1		

Table 5: SPI timing parameters

The MISO pin is kept in high impedance when the SSB level is high, which allows sharing the SPI bus with other components.

**IMPORTANT NOTE: It is forbidden to keep SPI pads at a high level while VDD is at 0V due to ESD protection diodes and buffers.**

## 6.2. SPI frames description

The SPI frames used for the communication through the SPI Register are composed of an instruction followed by arguments. The SPI instruction is composed of 1 byte, and the arguments are composed of 2, 4 or 8 bytes, depending on the cases, as can be seen in Table 6 below.

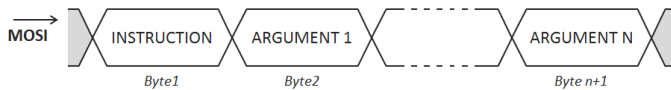

Figure 21: SPI Message Structure

Instruction	Argument	Meaning
0x50	0x00000000 (n=4)	Read Angular Rate
0x54	0x0000 (n=2)	Read Temperature
0x58	0x00000000 (n=4)	Advanced commands. See Section 6.5 for more details.
0x78	0XXXXXXXX (n=8)	
0x7C	0XXXXX (n=2)	

Table 6: Authorized SPI commands

## 6.3. Angular rate readings

From the 32-bits (4 bytes) frame obtained after the “Read Angular Rate” instruction, the 24-bits word of angular rate data (RATE) must be extracted as shown below in Figure 22.

DRY and ST are respectively the “data ready” and “self-test” bits.



Figure 22: Angular rate reading frames and data organization

### 6.3.1. Angular rate (RATE) output

The 24-bit gyro output is coded in two's complement (Table 7).

- If the temperature compensation is not enabled (GOUT\_SEL=1), then the user should perform scale factor measurements.
- If the temperature compensation of the angular rate output is enabled (default case), dividing the

24-bit value by a factor **10 000** results in the angular rate in °/s, as shown in Table 7.

-600.0000	°/s	↔	1010 0100 0111 0010 1000 0000
...			
-300.0000	°/s	↔	1101 0010 0011 1001 0100 0000
...			
-0.0002	°/s	↔	1111 1111 1111 1111 1111 1110
-0.0001	°/s	↔	1111 1111 1111 1111 1111 1111
0.0000	°/s	↔	0000 0000 0000 0000 0000 0000
+0.0001	°/s	↔	0000 0000 0000 0000 0000 0001
+0.0002	°/s	↔	0000 0000 0000 0000 0000 0010
...			
+300.0000	°/s	↔	0010 1101 1100 0110 1100 0000
...			
+600.0000	°/s	↔	0101 1011 1000 1101 1000 0000

Table 7: Conversion table for calibrated angular rate output

### 6.3.2. Data Ready (DRY) bit

The Data Ready bit is a flag which is raised when a new angular rate data is available. The flag stays raised until the new data is read.

### 6.3.3. Self-Test (ST) bit

The ST bit raises a flag (1 logic) at the same frequency as the angular rate output data rate indicating whether if the sensor is properly operating (i.e. whether the drive loop control provides stable drive oscillations amplitude).

The self-test procedure is running in parallel to the main functions of the sensor.

The ST data is also available on the pin 15. This pin is set to VDD when the sensor is working properly.

## 6.4. Temperature readings

The temperature data is an unsigned integer, 12-bits word (TEMP). It must be extracted from the 2 bytes of read data, as shown below in Figure 23.

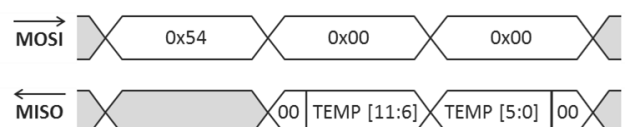

Figure 23: Temperature reading frames and data organization

By default the temperature sensor is *not* factory-calibrated (TOUTSEL=0).

### 6.5. Advanced use of SPI registers

SPI registers can also be used to access the System register or the MTP (Multi-Time-Programmable memory).

#### 6.5.1. R/W access to the System Registers

**IMPORTANT NOTE:** Modifications to the system registers are **reversible**. Modified registers will *not* be restored after a RESET. There is no limitation to the number of times the system registers can be modified.

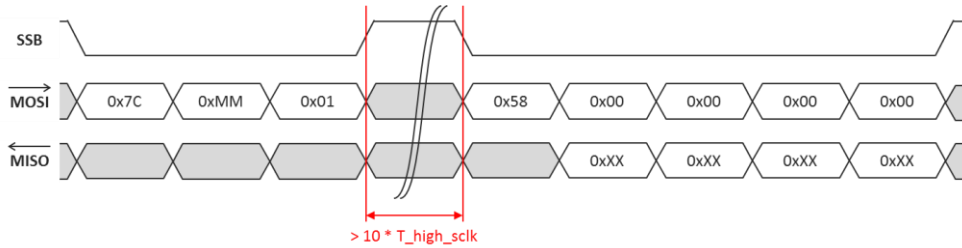

Figure 24: Sequence of instructions to READ address 0xMM of the system registers

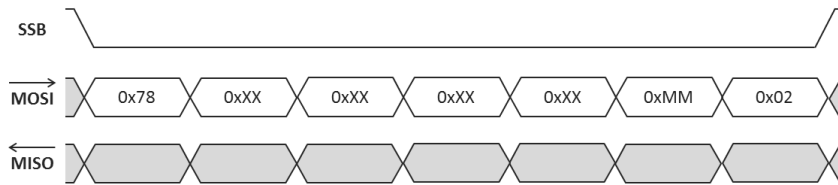

Figure 25: Sequence of instructions to WRITE '0xXXXXXXXX' to address '0xMM' of the system registers

#### 6.5.2. R/W access to the MTP

**IMPORTANT NOTE:** Modifications to the MTP are **non-reversible**. Modified parameters will be restored, even after a RESET, and previous values of the MTP cannot be accessed anymore. The maximum number of times the MTP can be written depends on the address:

- 7 times for the angular rate calibration coefficients (see Section 7 for more details)
- Only 1 time for all the other coefficients, including the temperature sensor calibration coefficients.

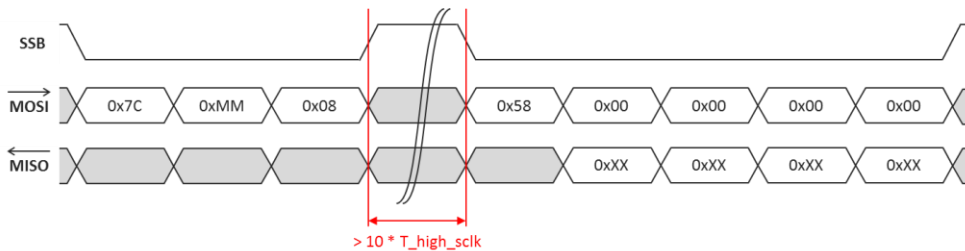

Figure 26 : Sequence of instructions to READ address 0xMM of the MTP

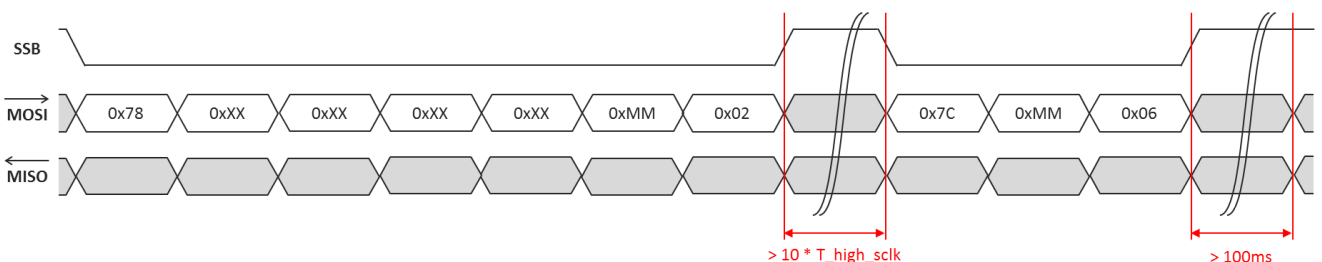

Figure 27: Sequence of instructions to WRITE data '0xXXXXXXXX' to address '0xMM' of the MTP

### 6.5.3. Useful Sensor Parameters

The instructions given in Sections 6.5.1 and 6.5.2 can be used to read and/or to modify the sensor's useful parameters given in Table 8 below.

Parameter	Address M (System Register & MTP)	Bits	Encoding	Meaning
<b>Sensor Identification</b>				
UID	0x00	[30:1]	Tronics reserved	Sensor 'Unique Identification' number
<b>Temperature output compensation</b>				
TOUT_SEL	0x09	2*	0 ** 1	Disable the calibrated temperature output Enable the calibrated temperature output
O	0x04	[27:16] *	0x000 ** See section 8	Offset calibration of temperature sensor
G	0x04	[13:2] *	0x800 ** See section 8	Gain calibration of temperature sensor
<b>Angular rate output compensation</b>				
GOUT_SEL	0x02	27 *	0** 1	Enable the calibrated angular rate output Disable the calibrated angular rate output
SF2	0x2E	[31:16] *	See Table 9	Scale Factor 2 <sup>nd</sup> order coefficient (calibrated angular rate)
B2	0x2E	[15:0] *	See Table 9	Bias 2 <sup>nd</sup> order coefficient (calibrated angular rate)
B1	0x2F	[29:0] *	See Table 9	Bias 1 <sup>st</sup> order coefficient (calibrated angular rate)
B0	0x30	[29:0] *	See Table 9	Bias constant coefficient (calibrated angular rate)
SF1	0x31	[29:0] *	See Table 9	Scale Factor 1 <sup>st</sup> order coefficient (calibrated angular rate)
SF0	0x32	[29:0] *	See Table 9	Scale Factor constant coefficient (calibrated angular rate)
TMID	0x33	[19:0] *	See Table 9	Mid-temperature calibration point
MTPSLOTNB	0x02	[15:8] *	0b00000000 0b00000001 ** 0b00000011 ... 0b01111111 0b11111111	Unprogrammed part Programmed once, 7 slots remaining Programmed twice, 6 slots remaining ... Programmed 7 times, 1 slot remaining Programmed 8 times, no slot remaining

**Table 8: Useful parameters information**

Notes:

- \* The other bits at those addresses shall remain unchanged. Please make sure that you write them without modification!
- \*\* Default Value



## 7. Angular rate calibration procedure

### 7.1. Algorithm overview

After filtering, the raw angular rate sensor output is temperature compensated based on the on-chip temperature sensor output and the stored temperature compensation parameters.

#### 7.1.1. Angular rate output calibration model

The formula below models the link between raw and compensated angular rate outputs:

$$\text{RATE}[^{\circ}/\text{s}] = \frac{\text{RATE}_{\text{COMP}}[\text{LSB}]}{\text{SF}_{\text{setting}}[\text{LSB}/^{\circ}/\text{s}]} = \frac{\text{RATE}_{\text{RAW}}[\text{LSB}] - \text{BIAS}[\text{LSB}]}{\text{SF}[\text{LSB}/^{\circ}/\text{s}]}$$

where:

- RATE is the angular rate output converted in °/s;
- RATE<sub>COMP</sub> is the calibrated angular rate output;
- SF<sub>setting</sub> is the constant conversion factor from LSB to °/s for the calibrated angular rate output. Default value for this parameter is SF<sub>setting</sub> = 10 000;
- RATE<sub>RAW</sub> is the raw data angular rate output;
- BIAS is a polynomial (2<sup>nd</sup> degree) temperature-varying coefficient to model the sensor's bias temperature variations;
- SF is a polynomial (2<sup>nd</sup> degree) temperature-varying coefficient to model the sensor's Scale Factor temperature variations.

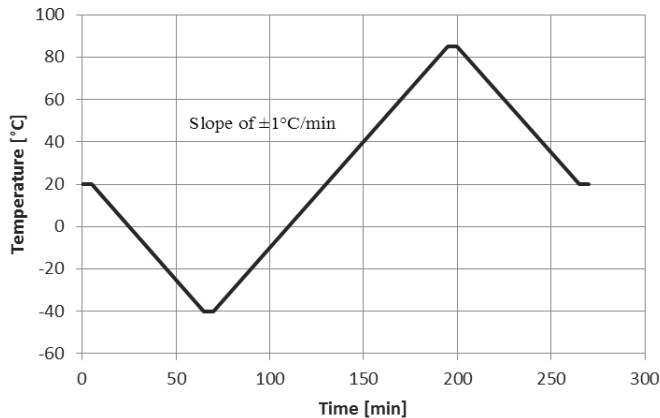

Figure 28: Recommended Temperature profile for calibration

#### 7.1.2. Recommended procedure

1. Set GOUT\_SEL to 1 in the System Registers (disable the calibration)
2. Place the sensor on a rate table in a thermal chamber and implement temperature profile according to Figure 28<sup>1</sup>
3. Perform continuous acquisition of the angular rate output with the following pattern:
  - Rest position (0°/s input) to evaluate the BIAS parameter
  - + 300°/s input then -300°/s input to evaluate the SF parameter<sup>2</sup>
4. Calculate the coefficients of BIAS and SF polynomials:

$$\text{BIAS} = \sum_{i=0}^2 b_i (T_{\text{RAW}} - T_{\text{MID}})^i$$

$$\text{SF} = \sum_{i=0}^2 sf_i (T_{\text{RAW}} - T_{\text{MID}})^i$$

where

- T<sub>RAW</sub> is the raw output of the temperature sensor **multiplied by 256**;
  - T<sub>MID</sub> is the mid-value of T<sub>RAW</sub>;
  - b<sub>0</sub> to b<sub>2</sub> are the 3 coefficients of BIAS polynomial;
  - sf<sub>0</sub> to sf<sub>2</sub> are the 3 coefficients of SF polynomial.
5. Convert T<sub>MID</sub>, b<sub>i</sub> and sf<sub>i</sub> parameters to their binary values according to Table 9 below:

Parameter	Value (decimal)	Format
SF2	sf <sub>2</sub> . 2 <sup>55</sup> / SF <sub>setting</sub>	signed 2's comp
SF1	sf <sub>1</sub> . 2 <sup>46</sup> / SF <sub>setting</sub>	signed 2's comp
SF0	sf <sub>0</sub> . 2 <sup>27</sup> / SF <sub>setting</sub>	signed 2's comp
B2	b <sub>2</sub> . 2 <sup>39</sup>	signed 2's comp
B1	b <sub>1</sub> . 2 <sup>35</sup>	signed 2's comp
B0	b <sub>0</sub>	signed 2's comp
TMID	T <sub>MID</sub>	unsigned

Table 9: Angular rate calibration parameters

<sup>1</sup> Temperature profile can be adapted to be in line with customer applications

<sup>2</sup> Rate applied can be adapted to be in line with customer applications



## 7.2. Programming of the new coefficients

**IMPORTANT NOTE:** The following steps are **non-reversible**. The previous values of the coefficients will not be accessible anymore. The temperature compensation coefficients can be re-programmed up to 7 additional times on the IC.

The programming procedure consists in three major steps:

- Checking the available MTP slot status
- Programming the coefficients
- Updating the available MTP slot status

An overview of the procedure is given in Figure 29.

### 7.2.1. Checking the MTP slot status

The first step is to check the number of remaining MTP slots (MTPSLOTNB), in other words, checking how many times the chip has been programmed before.

The detailed information of MTPSLOTNB register content is given in Table 8. The sequence of instructions to read the register is given in Figure 26.

The MTP slot number (MTPSLOTNB) re-programming iteration is given in the following table:

Iteration	Correspondence	MTP number	
		Value	Binary
0	Unprogrammed part	0	00000000
1	Programmed once	1*	00000001
2	Programmed twice	3	00000011
3		7	00000111
4		15	00001111
5	...	31	00011111
6		63	00111111
7		127	01111111
8	Cannot be further programmed	255	11111111

Table 10: MTPSLOTNB iterations

\* Default value

### 7.2.2. Programming the coefficients

This step describes the procedure for programming the calculated coefficients (temperature compensation of angular rate output). The programming procedure is:

1. Write SF2 in the system register
2. Write B2 in the system register
3. Program SF2 & B2 in the MTP
4. Write SF1 in the system register
5. Program SF1 in the MTP
6. Write SF0 in the system register
7. Program SF0 in the MTP
8. Write B1 in the system register

9. Program B1 in the MTP
10. Write B0 in the system register
11. Program B0 in the MTP
12. Write TMID in the system register
13. Program TMID

The detailed SPI commands are given in section 6.5. The detailed information about each coefficient is given in Table 8.

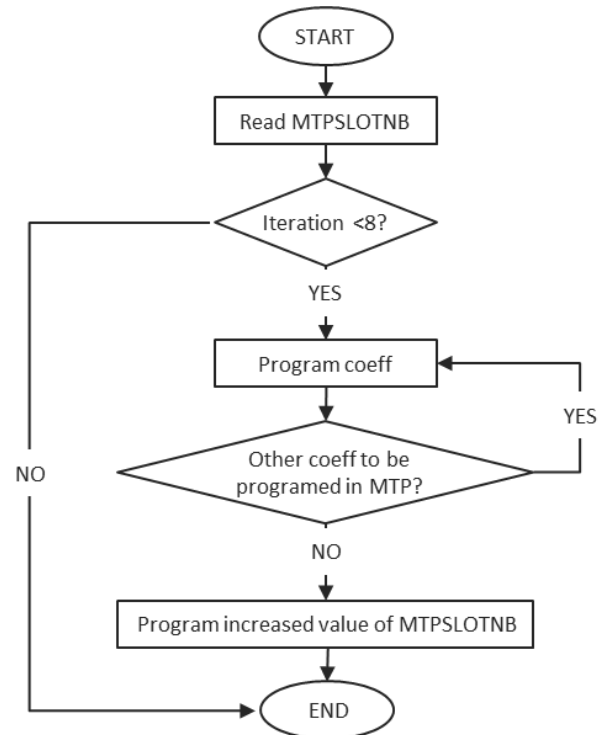

Figure 29 Procedure to program new calibration parameters

### 7.2.3. Updating MTP slot status

This section describes the procedure for programming the updated status of the MTP slots.

**If this step is not performed properly, the new compensation coefficients will not be effective.**

1. Read the MTPSLOTNB as described in section 6.5.2.
2. Increment MTPSLOTNB according to Table 10.
3. Write the updated MTPSLOTNB in the system register.
4. Program the updated MTPSLOTNB in the MTP.
5. After a reset, the new coefficients will be available.

## 7.3. Switch to uncompensated data output

To optimize the thermal compensation of the angular rate output, it is possible to disable the on-chip compensation and use the uncompensated (raw) output to perform an external thermal compensation.

To switch the output to uncompensated data, the procedure is described on section 6.5, by modifying the GOUT register described on Table 8.

## 8. Temperature Sensor Calibration Procedure

The temperature output of GYPRO2300 sensors is *not* factory-calibrated, since only the relative temperature output is needed to perform temperature compensation of the angular rate output. However, it is possible to perform a first-order polynomial calibration of the temperature sensor, in order to output the absolute temperature information.

This section shows how to get and store temperature calibration parameters for the temperature output.

### 8.1. Temperature sensor calibration model

The formula below models the link between raw and calibrated temperature output:

$$T[^\circ\text{C}] = \frac{T_{\text{COMP}}[\text{LSB}]}{\text{GAIN}_{\text{setting}}[\text{LSB}/^\circ\text{C}]} = \frac{\text{GAIN} \cdot T_{\text{RAW}}[\text{LSB}] + \text{OFFSET}[\text{LSB}]}{\text{GAIN}_{\text{setting}}[\text{LSB}/^\circ\text{C}]}$$

where:

- T is the output temperature converted in °C;
- T<sub>COMP</sub> is the calibrated temperature output;
- GAIN<sub>setting</sub> is the constant conversion factor from LSB to °C for the calibrated temperature output. This gain is set to 20LSB/°C to provide an output resolution of 0,1°C;
- T<sub>RAW</sub> is the raw data temperature output;
- **OFFSET** is a constant coefficient to tune the offset;
- **GAIN** is a constant coefficient to tune gain.

The **OFFSET** and **GAIN** parameters will be computed and written in the ASIC as per the following calibration procedure.

### 8.2. Recommended Procedure

1. Check that TOUT\_SEL = 0. If not, set it to 0 in the System Registers.
2. Measure the temperature output with at least 2 temperature points T<sub>1</sub> and T<sub>2</sub>.

3. Calculate the GAIN and OFFSET coefficients according to formula above.

$$\text{GAIN} = \text{GAIN}_{\text{setting}} \cdot \frac{T1_{\text{ABS}}[^\circ\text{C}] - T2_{\text{ABS}}[^\circ\text{C}]}{T1_{\text{RAW}}[\text{LSB}] - T2_{\text{RAW}}[\text{LSB}]}$$

$$\text{OFFSET} = \text{GAIN}_{\text{setting}} \cdot T1_{\text{ABS}}[^\circ\text{C}] - \text{GAIN} \cdot T1_{\text{RAW}}[\text{LSB}]$$

where:

- T<sub>1ABS</sub> is the absolute temperature of T<sub>1</sub> in °C;
- T<sub>2ABS</sub> is the absolute temperature of T<sub>2</sub> in °C;
- T<sub>1RAW</sub> is the raw output temperature of T<sub>1</sub> in LSB;
- T<sub>2RAW</sub> is the raw output temperature of T<sub>2</sub> in LSB;

4. Convert GAIN and OFFSET to their binary values according to Table 11 below:

Parameter	Value (decimal)	Format
G	GAIN . 2 <sup>09</sup>	Unsigned
O	OFFSET	Unsigned

**Table 11: Temperature calibration parameters**

5. [ Optional step: Write GAIN and OFFSET into the System Registers and repeat step 2. to check the accuracy of the new calibration. ]
6. Write GAIN and OFFSET into the MTP according to instructions of Section 6.5.2. Meanwhile, set TOUT\_SEL to 1 during this step, so that the new calibration parameters are effective after a RESET.

## 9. Device Identification / Ordering information

### 9.1. Device identification

GYPRO2300 tracking information is accessible on the label, as shown in the next figure.

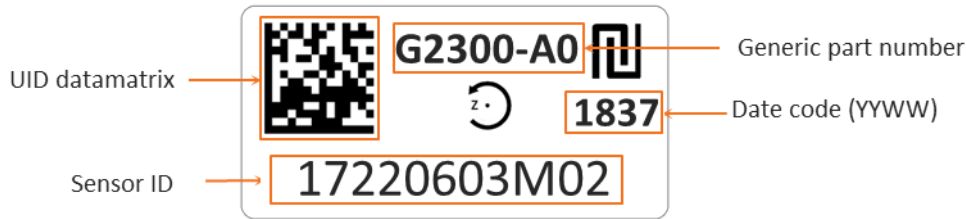

Figure 30: GYPRO2300 label.

### 9.2. Ordering information

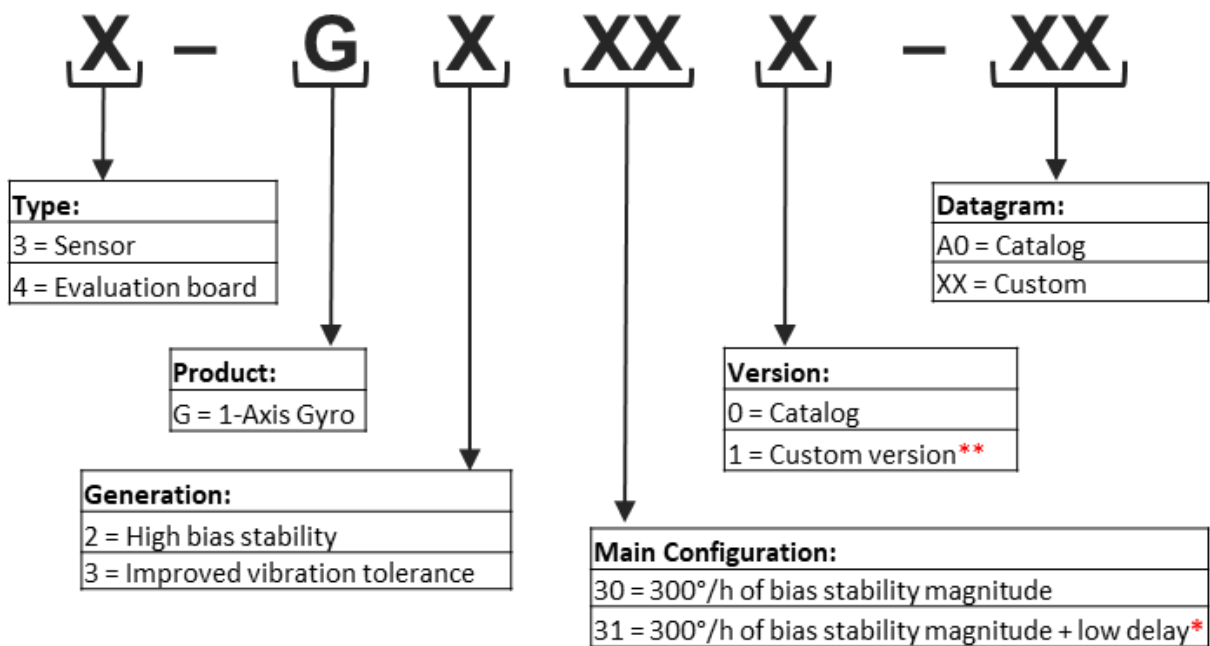

Figure 31 Ordering information

\* For second 2<sup>nd</sup> generation only

\*\* Custom version or specific requirement can be address upon request.

Product	Ordering code
GYPRO2300	3-G2300-A0
GYPRO2300LD	3-G2310-A0
GYPRO3300	3-G3300-A0
GYPRO2300-EVB2	4-G2300-A0
GYPRO2300LD-EVB2	4-G2310-A0
GYPRO3300-EVB2	4-G3300-A0

## 10. Internal construction and Theory of Operation

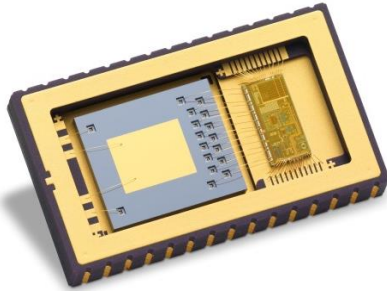

Figure 32 : Inner view of the package, showing the MEMS and IC

GYPRO series is using the dominant architecture for high performance MEMS gyro, namely the “Tuning fork or dual mass” design.

In details, each sensor consists in a MEMS transducer and an integrated circuit (IC) packaged in a 30-pins Ceramic Leadless Chip Carrier Package.

The sensing element (MEMS die), which is located on the left part of the Figure 32, is manufactured using Tronic's wafer-level packaging technology based on micro-machined thick single crystal silicon. The MEMS consists of two coupled sub-structures subjected to linear anti-phase vibrations. The structures are vacuumed at the wafer-level providing high Q-factor in the drive mode. The drive system is decoupled from the sense system in order to reduce feedback from sense motion to drive electrodes. The drive anti phase vibration is sustained by electrostatic comb drives. The sense anti phase vibration resulting from Coriolis forces is counter balanced by electrostatic forces. Differential detection and actuation are used for both drive and sense systems and for each sub-structure, keeping two identical structures for efficient common mode rejection.

The integrated circuit (IC), which is located on the right part of the Figure 32, is designed to interface the MEMS sensing element. It includes ultra-low noise capacitive to voltage converters (C2V) followed by high resolution voltage digitization (ADC) for both drive and sense paths. Excitation voltage required for capacitance sensing circuits is generated on the common electrode node. 1-bit force feedbacks (DAC) are used for both drive and sense system actuation.

The choice for the implemented close-loop architecture based on a Sigma-Delta principle is particularly well adapted as it brings the following key advantages:

1) Sigma-Delta is well suited for low-frequency signals. Noise shaping principle rejects quantization noise in high frequency bands.

2) Simplicity of hardware implementation. Oversampling concept allows significant design relaxation of the analog detection chain signal resolution. Additionally the voltage reference used for actuation force feedback is also of simple implementation as it is a 1-bit D/A converter, thus simplifying its design.

3) Linearization of the electrostatic forces thanks to the Sigma-delta principle (through force averaging) furthermore reduces non-linearity overall and more importantly its even-order terms, which result in rectification error.

4) Sigma-Delta signal output is inherently a digital signal, thus suppressing the need for costly high resolution A/D converter.

The digital part implements digital drive and sense loops, demodulates, decimates and processes the gyro output based on the on-chip temperature sensor output. The system controller manages the interface between the SPI registers, the system register and the non-volatile memory (OTP). The non-volatile memory provides the gyro settings, in particular the coefficients for angular rate sensor temperature compensation. On power up, the gyro settings are transferred from the OTP to the system registers and output data are available in the SPI registers. The angular rate sensor output and the temperature sensor output are available in the SPI registers. The SPI registers are available through the SPI interface (SSB, SCLK, MOSI, MISO). The self-test is available on the external pins ST.













The “References” block generates the required biasing currents and voltages for all blocks as well as the low-noise reference voltage for critical blocks.

The “Power Management” block manages the power supply of the sensor from a single 5V supply between the VDD and GND pins. It includes a power on reset as well as an external reset pin (RSTB) to start or restart operation using default configuration. An enable pin (EN) with power-down capability is also available.

The sensor is powered with a single 5V DC power supply through pins VDD and GND. Although the sensor contains three separate VDD pins, the sensor is supplied by a single 5V voltage source. It is recommended to supply the three VDD pins in a star connection with appropriate decoupling capacitors. Regarding the sensor grounds, all the GND pins are internally shorted. The GND pins redundancy is used for multiple bonds in order to reduce the total ground inductance. It is therefore recommended to connect all the GND pins to the ground.

## 11. Available Tools and Resources

The following tools and resources are available on the GYPRO® product page of our [website](#) or upon request.

Item	Description
<b>Documentation &amp; technical notes</b>	
	<b>GYPRO® product line - Flyer</b>
	<b>GYPRO® product – Technical note</b> External filtering for Gypro2300LD and Gypro3300
	<b>GYPRO® product – Technical note</b> GYPRO MTBF Methodology
<b>Mechanical tools</b>	
	<b>GYPRO2300 – 3D model</b>
<b>Evaluation kit</b>	
	<b>GYPRO2300-EVB2 – Evaluation board</b> Evaluation board for GYPRO2300, compatible with Arduino Yun_rev2
	<b>Evaluation Board – User manual</b>
	<b>Evaluation Kit – Quick start guide</b>
	<b>Evaluation Tool – Software user manual</b>
	<b>GYPRO® Evaluation Tool – Tutorial</b> Installation and programming of the Evaluation kit
	<b>GYPRO® Evaluation Tool – Tutorial</b> Software
	<b>Evaluation Tool – Software</b>
	<b>Evaluation Tool – Arduino Firmware</b>



Компания «ЭлектроПласт» предлагает заключение долгосрочных отношений при поставках импортных электронных компонентов на взаимовыгодных условиях!

Наши преимущества:

- Оперативные поставки широкого спектра электронных компонентов отечественного и импортного производства напрямую от производителей и с крупнейших мировых складов;
- Поставка более 17-ти миллионов наименований электронных компонентов;
- Поставка сложных, дефицитных, либо снятых с производства позиций;
- Оперативные сроки поставки под заказ (от 5 рабочих дней);
- Экспресс доставка в любую точку России;
- Техническая поддержка проекта, помощь в подборе аналогов, поставка прототипов;
- Система менеджмента качества сертифицирована по Международному стандарту ISO 9001;
- Лицензия ФСБ на осуществление работ с использованием сведений, составляющих государственную тайну;
- Поставка специализированных компонентов (Xilinx, Altera, Analog Devices, Intersil, Interpoint, Microsemi, Aeroflex, Peregrine, Syfer, Eurofarad, Texas Instrument, Miteq, Cobham, E2V, MA-COM, Hittite, Mini-Circuits, General Dynamics и др.);

Помимо этого, одним из направлений компании «ЭлектроПласт» является направление «Источники питания». Мы предлагаем Вам помощь Конструкторского отдела:

- Подбор оптимального решения, техническое обоснование при выборе компонента;
- Подбор аналогов;
- Консультации по применению компонента;
- Поставка образцов и прототипов;
- Техническая поддержка проекта;
- Защита от снятия компонента с производства.



#### Как с нами связаться

**Телефон:** 8 (812) 309 58 32 (многоканальный)

**Факс:** 8 (812) 320-02-42

**Электронная почта:** [org@eplast1.ru](mailto:org@eplast1.ru)

**Адрес:** 198099, г. Санкт-Петербург, ул. Калинина, дом 2, корпус 4, литера А.