

# TUHS3

TUH S 3 F 05

① ② ③ ④ ⑤

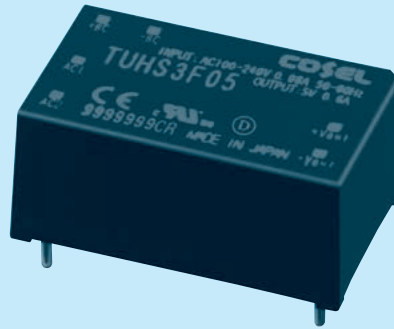

- ① Series name
- ② Single output
- ③ Output wattage
- ④ Universal Input
- ⑤ Output voltage

□ Class II

\* Avoid short circuit between +BC and -BC. It may cause the failure of inside components.  
 \* To use TUHS, external components are required. Refer to the instruction manual for details.

| MODEL                 | TUHS3F05 | TUHS3F12  | TUHS3F15 | TUHS3F24  |
|-----------------------|----------|-----------|----------|-----------|
| MAX OUTPUT WATTAGE[W] | 3.00     | 3.00      | 3.00     | 3.12      |
| DC OUTPUT             | 5V 0.6A  | 12V 0.25A | 15V 0.2A | 24V 0.13A |

## SPECIFICATIONS

|                               | MODEL                                | TUHS3F05  | TUHS3F12          | TUHS3F15      | TUHS3F24      |        |
|-------------------------------|--------------------------------------|---|-------------------|---------------|---------------|--------|
| INPUT                         | VOLTAGE[V]                           | AC85 - 264 1 φ DC120 - 370  |                   |               |               |        |
|                               | CURRENT[A]                           | ACIN 100V   | 0.08typ (Io=100%) |               |               |        |
|                               |                                      | ACIN 200V   | 0.05typ (Io=100%) |               |               |        |
|                               | FREQUENCY[Hz]                        | 50/60 (47 - 63)   |                   |               |               |        |
|                               | EFFICIENCY[%]                        | ACIN 100V   | 79typ             | 81typ         | 81typ         | 81typ  |
| ACIN 200V                     |                                      | 78typ   | 79typ             | 79typ         | 79typ         |        |
| INRUSH CURRENT                | Limited by external components       |   |                   |               |               |        |
| OUTPUT                        | VOLTAGE[V]                           | 5   | 12                | 15            | 24            |        |
|                               | CURRENT[A]                           | 0.6   | 0.25              | 0.2           | 0.13          |        |
|                               | LINE REGULATION[mV]                  | 20max   | 48max             | 60max         | 96max         |        |
|                               | LOAD REGULATION[mV]                  | 40max   | 100max            | 120max        | 150max        |        |
|                               | RIPPLE[mVp-p]                        | 30 to 100% Load *1  | 120max            | 160max        | 160max        | 200max |
|                               |                                      | 0 to 30% Load AC85V - 240V *1   | 400max            | 480max        | 480max        | 580max |
|                               | RIPPLE NOISE[mVp-p]                  | 30 to 100% Load *1  | 160max            | 200max        | 200max        | 240max |
|                               |                                      | 0 to 30% Load AC85V - 240V *1   | 480max            | 560max        | 560max        | 660max |
|                               | TEMPERATURE REGULATION[mV]           | 0 to +85°C  | 100max            | 180max        | 240max        | 360max |
|                               |                                      | -40 to +85°C  | 150max            | 270max        | 360max        | 480max |
| DRIFT[mV]                     | *2                                   | 20max   | 48max             | 60max         | 96max         |        |
| OUTPUT VOLTAGE SETTING[V]     |                                      | 4.90 - 5.30   | 11.40 - 12.60     | 14.25 - 15.75 | 23.00 - 25.00 |        |
| PROTECTION CIRCUIT AND OTHERS | OVERCURRENT PROTECTION               | Works over 105% of rating and recover automatically   |                   |               |               |        |
|                               | OVERVOLTAGE PROTECTION[V]            | 5.50 - 8.00   | 13.20 - 19.20     | 16.50 - 24.00 | 26.40 - 38.40 |        |
| ISOLATION                     | INPUT-OUTPUT                         | AC3,000V 1minute, Cutoff current = 10mA, DC500V 50MΩ min (20±15°C)                            |                   |               |               |        |
| ENVIRONMENT                   | OPERATING TEMP., HUMID. AND ALTITUDE | -40 to +85°C, 20 - 95%RH (Non condensing) (Refer to DERATING CURVE), 3,000m (10,000 feet) max |                   |               |               |        |
|                               | STORAGE TEMP., HUMID. AND ALTITUDE   | -40 to +100°C, 20 - 95%RH (Non condensing), 9,000m (30,000 feet) max                          |                   |               |               |        |
|                               | VIBRATION                            | 10 - 55Hz, 49.0m/s <sup>2</sup> (5G), 3minutes period, 60minutes each along X, Y and Z axis   |                   |               |               |        |
|                               | IMPACT                               | 196.1m/s <sup>2</sup> (20G), 11ms, once each along X, Y and Z axis                            |                   |               |               |        |
| SAFETY AND NOISE REGULATIONS  | AGENCY APPROVALS                     | UL60950-1, C-UL (CSA60950-1), EN60950-1   |                   |               |               |        |
|                               | CONDUCTED NOISE                      | Complies with FCC-B, VCCI-B, CISPR-B, EN55022-B *3  |                   |               |               |        |
|                               | HARMONIC ATTENUATOR                  | Complies with IEC61000-3-2 (Class A) (Not built-in to active filter)                          |                   |               |               |        |
| OTHERS                        | CASE SIZE/WEIGHT                     | 28.7 X 12.7 X 17.5mm[1.13 X 0.50 X 0.69 inches] (W X H X D) / 15g max                         |                   |               |               |        |
|                               | COOLING METHOD                       | Convection / Forced air   |                   |               |               |        |

\*1 Refer to instruction manual for measuring method of electric characteristics.  
 \*2 Drift is the change in DC output for an eight hour period after a half-hour warm-up at 25°C, with the input voltage held constant at the rated value.  
 \*3 Do not ground secondly circuit, in case of a standard adapted.  
 \* Measured with 18μF capacitor as Cbc.

External view

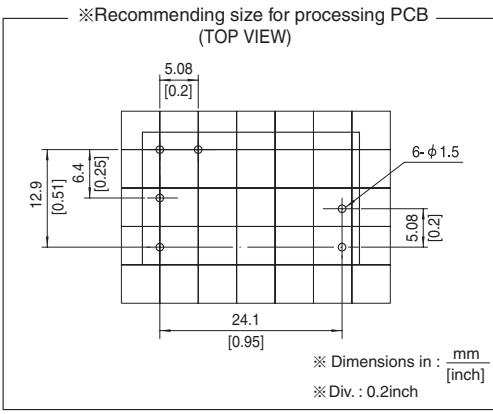
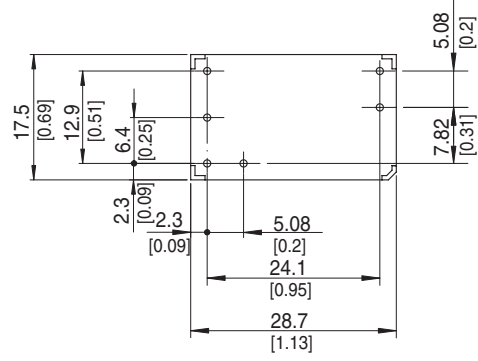
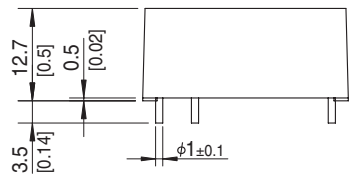
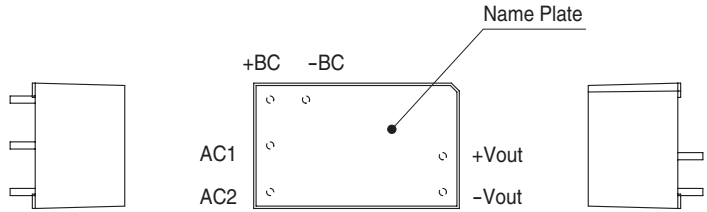

- ※ Tolerance :  $\pm 0.5$  [ $\pm 0.02$ ]
- ※ Weight : 15g max
- ※ Case material : PBT
- ※ Pin material : Copper
- ※ Plating treatment of pin : Lead free plating
- ※ Dimensions in mm, [ ]=inches

# TUHS5

TUH S 5 F 05

① ② ③ ④ ⑤

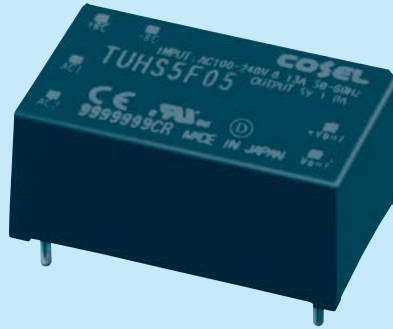

- ① Series name
- ② Single output
- ③ Output wattage
- ④ Universal Input
- ⑤ Output voltage

□ Class II

\* Avoid short circuit between +BC and -BC. It may cause the failure of inside components.  
 \* To use TUHS, external components are required. Refer to the instruction manual for details.

| MODEL                 | TUHS5F05 | TUHS5F12  | TUHS5F15  | TUHS5F24  |
|-----------------------|----------|-----------|-----------|-----------|
| MAX OUTPUT WATTAGE[W] | 5.00     | 5.40      | 5.10      | 5.28      |
| DC OUTPUT             | 5V 1A    | 12V 0.45A | 15V 0.34A | 24V 0.22A |

## SPECIFICATIONS

|                               | MODEL                                | TUHS5F05  | TUHS5F12          | TUHS5F15      | TUHS5F24      |        |
|-------------------------------|--------------------------------------|---|-------------------|---------------|---------------|--------|
| INPUT                         | VOLTAGE[V]                           | AC85 - 264 1 φ DC120 - 370  |                   |               |               |        |
|                               | CURRENT[A]                           | ACIN 100V   | 0.13typ (Io=100%) |               |               |        |
|                               |                                      | ACIN 200V   | 0.08typ (Io=100%) |               |               |        |
|                               | FREQUENCY[Hz]                        | 50/60 (47 - 63)   |                   |               |               |        |
|                               | EFFICIENCY[%]                        | ACIN 100V   | 78typ             | 82typ         | 82typ         | 83typ  |
| ACIN 200V                     |                                      | 79typ   | 82typ             | 82typ         | 83typ         |        |
| INRUSH CURRENT                | Limited by external components       |   |                   |               |               |        |
| OUTPUT                        | VOLTAGE[V]                           | 5   | 12                | 15            | 24            |        |
|                               | CURRENT[A]                           | 1   | 0.45              | 0.34          | 0.22          |        |
|                               | LINE REGULATION[mV]                  | 20max   | 48max             | 60max         | 96max         |        |
|                               | LOAD REGULATION[mV]                  | 40max   | 100max            | 120max        | 150max        |        |
|                               | RIPPLE[mVp-p]                        | 30 to 100% Load *1  | 120max            | 160max        | 160max        | 200max |
|                               |                                      | 0 to 30% Load<br>AC85V - 240V *1  | 400max            | 480max        | 480max        | 580max |
|                               | RIPPLE NOISE[mVp-p]                  | 30 to 100% Load *1  | 160max            | 200max        | 200max        | 240max |
|                               |                                      | 0 to 30% Load<br>AC85V - 240V *1  | 480max            | 560max        | 560max        | 660max |
|                               | TEMPERATURE REGULATION[mV]           | 0 to +80°C  | 100max            | 180max        | 240max        | 360max |
|                               |                                      | -40 to +80°C  | 150max            | 270max        | 360max        | 480max |
| DRIFT[mV]                     | *2                                   | 20max   | 48max             | 60max         | 96max         |        |
| OUTPUT VOLTAGE SETTING[V]     |                                      | 4.90 - 5.30   | 11.40 - 12.60     | 14.25 - 15.75 | 23.00 - 25.00 |        |
| PROTECTION CIRCUIT AND OTHERS | OVERCURRENT PROTECTION               | Works over 105% of rating and recover automatically   |                   |               |               |        |
|                               | OVERVOLTAGE PROTECTION[V]            | 5.50 - 8.00   | 13.20 - 19.20     | 16.50 - 24.00 | 26.40 - 38.40 |        |
| ISOLATION                     | INPUT-OUTPUT                         | AC3,000V 1minute, Cutoff current = 10mA, DC500V 50MΩ min (20±15°C)                            |                   |               |               |        |
| ENVIRONMENT                   | OPERATING TEMP., HUMID. AND ALTITUDE | -40 to +85°C, 20 - 95%RH (Non condensing) (Refer to DERATING CURVE), 3,000m (10,000 feet) max |                   |               |               |        |
|                               | STORAGE TEMP., HUMID. AND ALTITUDE   | -40 to +100°C, 20 - 95%RH (Non condensing), 9,000m (30,000 feet) max                          |                   |               |               |        |
|                               | VIBRATION                            | 10 - 55Hz, 49.0m/s <sup>2</sup> (5G), 3minutes period, 60minutes each along X, Y and Z axis   |                   |               |               |        |
|                               | IMPACT                               | 196.1m/s <sup>2</sup> (20G), 11ms, once each along X, Y and Z axis                            |                   |               |               |        |
| SAFETY AND NOISE REGULATIONS  | AGENCY APPROVALS                     | UL60950-1, C-UL (CSA60950-1), EN60950-1   |                   |               |               |        |
|                               | CONDUCTED NOISE                      | Complies with FCC-B, VCCI-B, CISPR-B, EN55022-B *3  |                   |               |               |        |
|                               | HARMONIC ATTENUATOR                  | Complies with IEC61000-3-2 (Class A) (Not built-in to active filter)                          |                   |               |               |        |
| OTHERS                        | CASE SIZE/WEIGHT                     | 28.7 X 12.7 X 17.5mm[1.13 X 0.50 X 0.69 inches] (W X H X D) / 15g max                         |                   |               |               |        |
|                               | COOLING METHOD                       | Convection / Forced air   |                   |               |               |        |

\*1 Refer to instruction manual for measuring method of electric characteristics.  
 \*2 Drift is the change in DC output for an eight hour period after a half-hour warm-up at 25°C, with the input voltage held constant at the rated value.  
 \*3 Do not ground secondly circuit, in case of a standard adapted.  
 \* Measured with 22μF capacitor as Cbc.

External view

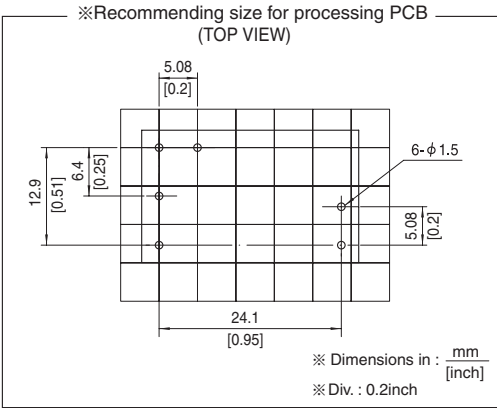
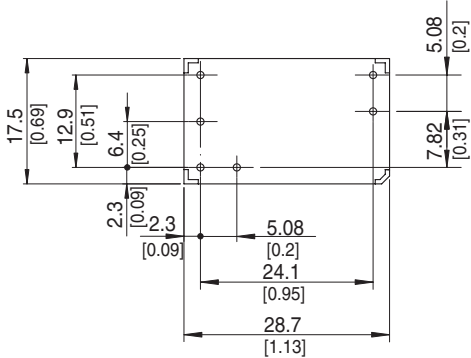
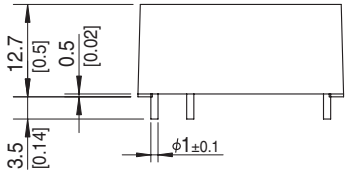
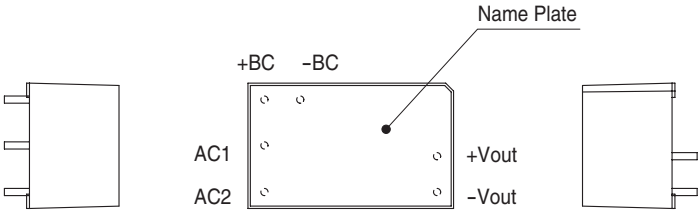

- ※ Tolerance :  $\pm 0.5$  [ $\pm 0.02$ ]
- ※ Weight : 15g max
- ※ Case material : PBT
- ※ Pin material : Copper
- ※ Plating treatment of pin : Lead free plating
- ※ Dimensions in mm, [ ]=inches

# TUHS10

TUH S 10 F 05

① ② ③ ④ ⑤

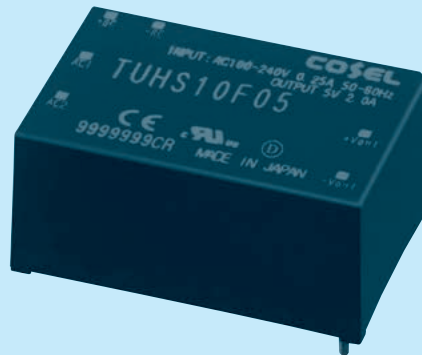

- ① Series name
- ② Single output
- ③ Output wattage
- ④ Universal Input
- ⑤ Output voltage

□ Class II

\* Avoid short circuit between +BC and -BC. It may cause the failure of inside components.  
 \* To use TUHS, external components are required. Refer to the instruction manual for details.

| MODEL                 | TUHS10F05 | TUHS10F12 | TUHS10F15 | TUHS10F24 |
|-----------------------|-----------|-----------|-----------|-----------|
| MAX OUTPUT WATTAGE[W] | 10.00     | 10.80     | 10.10     | 10.80     |
| DC OUTPUT             | 5V 2A     | 12V 0.9A  | 15V 0.67A | 24V 0.45A |

## SPECIFICATIONS

|                               | MODEL                                | TUHS10F05   | TUHS10F12         | TUHS10F15     | TUHS10F24     |        |
|-------------------------------|--------------------------------------|---|-------------------|---------------|---------------|--------|
| INPUT                         | VOLTAGE[V]                           | AC85 - 264 1 φ DC120 - 370  |                   |               |               |        |
|                               | CURRENT[A]                           | ACIN 100V   | 0.25typ (Io=100%) |               |               |        |
|                               |                                      | ACIN 200V   | 0.14typ (Io=100%) |               |               |        |
|                               | FREQUENCY[Hz]                        | 50/60 (47 - 63)   |                   |               |               |        |
|                               | EFFICIENCY[%]                        | ACIN 100V   | 81typ             | 85typ         | 85typ         | 86typ  |
| ACIN 200V                     |                                      | 82typ   | 85typ             | 85typ         | 87typ         |        |
| INRUSH CURRENT                | Limited by external components       |   |                   |               |               |        |
| OUTPUT                        | VOLTAGE[V]                           | 5   | 12                | 15            | 24            |        |
|                               | CURRENT[A]                           | 2   | 0.9               | 0.67          | 0.45          |        |
|                               | LINE REGULATION[mV]                  | 20max   | 48max             | 60max         | 96max         |        |
|                               | LOAD REGULATION[mV]                  | 40max   | 100max            | 120max        | 150max        |        |
|                               | RIPPLE[mVp-p]                        | 30 to 100% Load *1  | 120max            | 160max        | 160max        | 200max |
|                               |                                      | 0 to 30% Load AC85V - 240V *1   | 400max            | 480max        | 480max        | 580max |
|                               | RIPPLE NOISE[mVp-p]                  | 30 to 100% Load *1  | 160max            | 200max        | 200max        | 240max |
|                               |                                      | 0 to 30% Load AC85V - 240V *1   | 480max            | 560max        | 560max        | 660max |
|                               | TEMPERATURE REGULATION[mV]           | 0 to +70°C  | 100max            | 180max        | 240max        | 360max |
|                               |                                      | -40 to +70°C  | 150max            | 270max        | 360max        | 480max |
| DRIFT[mV]                     | *2                                   | 20max   | 48max             | 60max         | 96max         |        |
| OUTPUT VOLTAGE SETTING[V]     |                                      | 4.90 - 5.30   | 11.40 - 12.60     | 14.25 - 15.75 | 23.00 - 25.00 |        |
| PROTECTION CIRCUIT AND OTHERS | OVERCURRENT PROTECTION               | Works over 105% of rating and recover automatically   |                   |               |               |        |
|                               | OVERVOLTAGE PROTECTION[V]            | 5.50 - 8.00   | 13.20 - 19.20     | 16.50 - 24.00 | 26.40 - 38.40 |        |
| ISOLATION                     | INPUT-OUTPUT                         | AC3,000V 1minute, Cutoff current = 10mA, DC500V 50MΩ min (20±15°C)                            |                   |               |               |        |
| ENVIRONMENT                   | OPERATING TEMP., HUMID. AND ALTITUDE | -40 to +85°C, 20 - 95%RH (Non condensing) (Refer to DERATING CURVE), 3,000m (10,000 feet) max |                   |               |               |        |
|                               | STORAGE TEMP., HUMID. AND ALTITUDE   | -40 to +100°C, 20 - 95%RH (Non condensing), 9,000m (30,000 feet) max                          |                   |               |               |        |
|                               | VIBRATION                            | 10 - 55Hz, 49.0m/s <sup>2</sup> (5G), 3minutes period, 60minutes each along X, Y and Z axis   |                   |               |               |        |
|                               | IMPACT                               | 196.1m/s <sup>2</sup> (20G), 11ms, once each along X, Y and Z axis                            |                   |               |               |        |
| SAFETY AND NOISE REGULATIONS  | AGENCY APPROVALS                     | UL60950-1, C-UL (CSA60950-1), EN60950-1   |                   |               |               |        |
|                               | CONDUCTED NOISE                      | Complies with FCC-B, VCCI-B, CISPR-B, EN55022-B *3  |                   |               |               |        |
|                               | HARMONIC ATTENUATOR                  | Complies with IEC61000-3-2 (Class A) (Not built-in to active filter)                          |                   |               |               |        |
| OTHERS                        | CASE SIZE/WEIGHT                     | 33.0 X 15.0 X 22.0mm [1.3 X 0.59 X 0.86 inches] (W X H X D) / 25g max                         |                   |               |               |        |
|                               | COOLING METHOD                       | Convection / Forced air   |                   |               |               |        |

\*1 Refer to instruction manual for measuring method of electric characteristics.  
 \*2 Drift is the change in DC output for an eight hour period after a half-hour warm-up at 25°C, with the input voltage held constant at the rated value.  
 \*3 Do not ground secondly circuit, in case of a standard adapted.  
 \* Measured with 47μF capacitor as Cbc.

External view

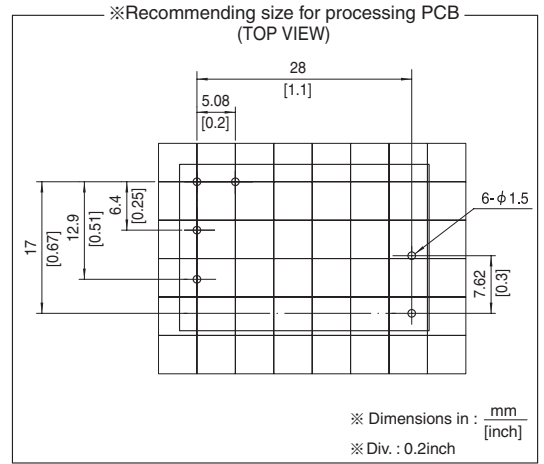
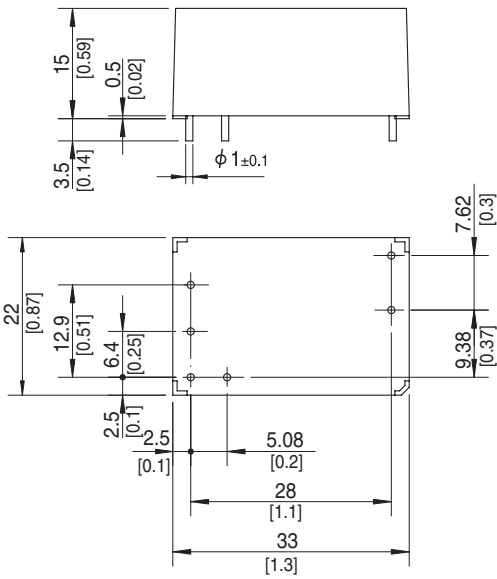
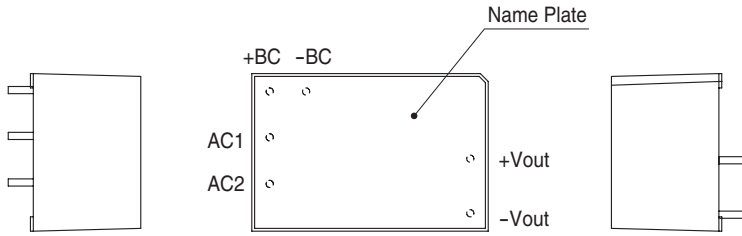

- ※ Tolerance :  $\pm 0.5$  [ $\pm 0.02$ ]
- ※ Weight : 25g max
- ※ Case material : PBT
- ※ Pin material : Copper
- ※ Plating treatment of pin : Lead free plating
- ※ Dimensions in mm, [ ]=inches

# TUHS15

TUH S 15 F 12

① ② ③ ④ ⑤

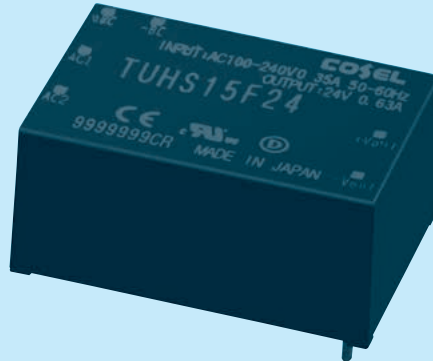

- ① Series name
- ② Single output
- ③ Output wattage
- ④ Universal Input
- ⑤ Output voltage

□ Class II

\* Avoid short circuit between +BC and -BC. It may cause the failure of inside components.  
 \* To use TUHS, external components are required. Refer to the instruction manual for details.

| MODEL                 | TUHS15F12 | TUHS15F15 | TUHS15F24 |
|-----------------------|-----------|-----------|-----------|
| MAX OUTPUT WATTAGE[W] | 15.00     | 15.00     | 15.12     |
| DC OUTPUT             | 12V 1.25A | 15V 1A    | 24V 0.63A |

## SPECIFICATIONS

|                               | MODEL                                | TUHS15F12   | TUHS15F15         | TUHS15F24     |        |
|-------------------------------|--------------------------------------|---|-------------------|---------------|--------|
| INPUT                         | VOLTAGE[V]                           | AC85 - 264 1 φ DC120 - 370  |                   |               |        |
|                               | CURRENT[A]                           | ACIN 100V   | 0.35typ (Io=100%) |               |        |
|                               |                                      | ACIN 200V   | 0.18typ (Io=100%) |               |        |
|                               | FREQUENCY[Hz]                        | 50/60 (47 - 63)   |                   |               |        |
|                               | EFFICIENCY[%]                        | ACIN 100V   | 85typ             | 85typ         | 86typ  |
|                               |                                      | ACIN 200V   | 85typ             | 85typ         | 87typ  |
| INRUSH CURRENT                | Limited by external components       |   |                   |               |        |
| OUTPUT                        | VOLTAGE[V]                           | 12  | 15                | 24            |        |
|                               | CURRENT[A]                           | 1.25  | 1                 | 0.63          |        |
|                               | LINE REGULATION[mV]                  | 48max   | 60max             | 96max         |        |
|                               | LOAD REGULATION[mV]                  | 100max  | 120max            | 150max        |        |
|                               | RIPPLE[mVp-p]                        | 30 to 100% Load *1  | 160max            | 160max        | 200max |
|                               |                                      | 0 to 30% Load<br>AC85V - 240V *1  | 480max            | 480max        | 580max |
|                               | RIPPLE NOISE[mVp-p]                  | 30 to 100% Load *1  | 200max            | 200max        | 240max |
|                               |                                      | 0 to 30% Load<br>AC85V - 240V *1  | 560max            | 560max        | 660max |
|                               | TEMPERATURE REGULATION[mV]           | 0 to +50°C  | 180max            | 240max        | 360max |
|                               |                                      | -40 to +50°C  | 270max            | 360max        | 480max |
| DRIFT[mV]                     | *2                                   | 48max   | 60max             | 96max         |        |
| OUTPUT VOLTAGE SETTING[V]     | 11.40 - 12.60                        | 14.25 - 15.75   | 23.00 - 25.00     |               |        |
| PROTECTION CIRCUIT AND OTHERS | OVERCURRENT PROTECTION               | Works over 105% of rating and recover automatically   |                   |               |        |
|                               | OVERVOLTAGE PROTECTION[V]            | 13.20 - 19.20   | 16.50 - 24.00     | 26.40 - 38.40 |        |
| ISOLATION                     | INPUT-OUTPUT                         | AC3,000V 1minute, Cutoff current = 10mA, DC500V 50MΩ min (20±15°C)                            |                   |               |        |
| ENVIRONMENT                   | OPERATING TEMP., HUMID. AND ALTITUDE | -40 to +85°C, 20 - 95%RH (Non condensing) (Refer to DERATING CURVE), 3,000m (10,000 feet) max |                   |               |        |
|                               | STORAGE TEMP., HUMID. AND ALTITUDE   | -40 to +100°C, 20 - 95%RH (Non condensing), 9,000m (30,000 feet) max                          |                   |               |        |
|                               | VIBRATION                            | 10 - 55Hz, 49.0m/s <sup>2</sup> (5G), 3minutes period, 60minutes each along X, Y and Z axis   |                   |               |        |
|                               | IMPACT                               | 196.1m/s <sup>2</sup> (20G), 11ms, once each along X, Y and Z axis                            |                   |               |        |
| SAFETY AND NOISE REGULATIONS  | AGENCY APPROVALS                     | UL60950-1, C-UL (CSA60950-1), EN60950-1   |                   |               |        |
|                               | CONDUCTED NOISE                      | Complies with FCC-B, VCCI-B, CISPR-B, EN55022-B *3  |                   |               |        |
|                               | HARMONIC ATTENUATOR                  | Complies with IEC61000-3-2 (Class A) (Not built-in to active filter)                          |                   |               |        |
| OTHERS                        | CASE SIZE/WEIGHT                     | 33.0 × 15.0 × 22.0mm [1.3 × 0.59 × 0.86 inches] (W × H × D) / 25g max                         |                   |               |        |
|                               | COOLING METHOD                       | Convection / Forced air   |                   |               |        |

\*1 Refer to instruction manual for measuring method of electric characteristics.  
 \*2 Drift is the change in DC output for an eight hour period after a half-hour warm-up at 25°C, with the input voltage held constant at the rated value.  
 \*3 Do not ground secondly circuit, in case of a standard adapted.  
 \* Measured with 68μF capacitor as Cbc.

External view

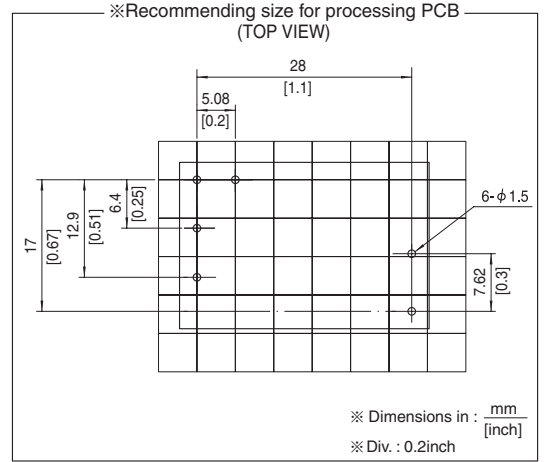
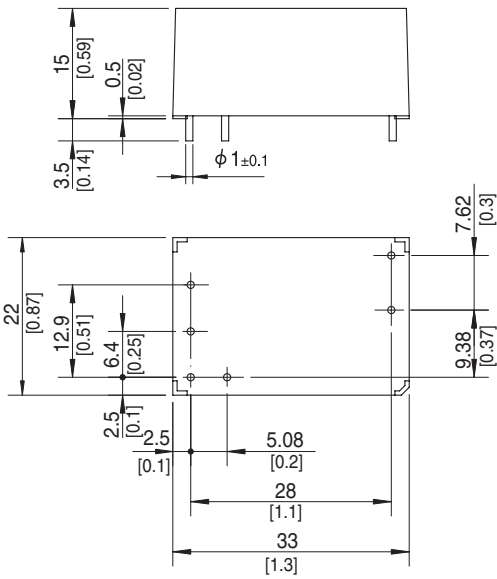
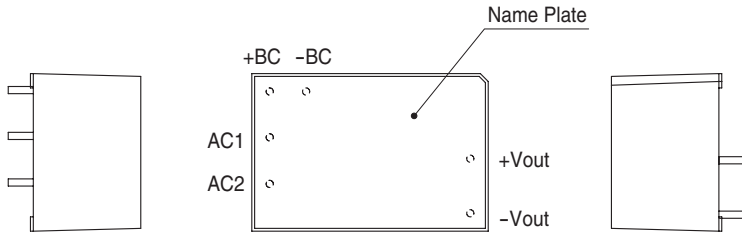

- ※ Dimensions in :  $\frac{\text{mm}}{[\text{inch}]}$
- ※ Div. : 0.2inch
- ※ Tolerance :  $\pm 0.5$  [ $\pm 0.02$ ]
- ※ Weight : 25g max
- ※ Case material : PBT
- ※ Pin material : Copper
- ※ Plating treatment of pin : Lead free plating
- ※ Dimensions in mm, [ ]=inches



# TUHS25

TUH S 25 F 05

① ② ③ ④ ⑤

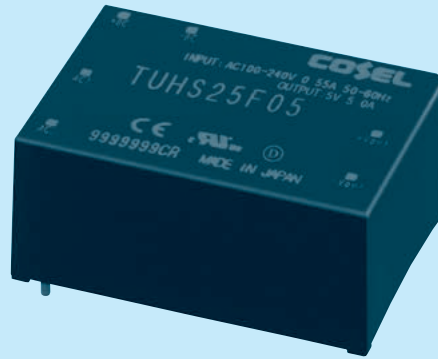

- ① Series name
- ② Single output
- ③ Output wattage
- ④ Universal Input
- ⑤ Output voltage

□ Class II

\* Avoid short circuit between +BC and -BC. It may cause the failure of inside components.  
 \* To use TUHS, external components are required. Refer to the instruction manual for details.

| MODEL                 | TUHS25F05 | TUHS25F12 | TUHS25F15 | TUHS25F24 |
|-----------------------|-----------|-----------|-----------|-----------|
| MAX OUTPUT WATTAGE[W] | 25.00     | 25.20     | 25.50     | 26.40     |
| DC OUTPUT             | 5V 5A     | 12V 2.1A  | 15V 1.7A  | 24V 1.1A  |

## SPECIFICATIONS

|                               | MODEL                                | TUHS25F05   | TUHS25F12         | TUHS25F15     | TUHS25F24     |        |
|-------------------------------|--------------------------------------|---|-------------------|---------------|---------------|--------|
| INPUT                         | VOLTAGE[V]                           | AC85 - 264 1 φ DC120 - 370  |                   |               |               |        |
|                               | CURRENT[A]                           | ACIN 100V   | 0.55typ (Io=100%) |               |               |        |
|                               |                                      | ACIN 200V   | 0.35typ (Io=100%) |               |               |        |
|                               | FREQUENCY[Hz]                        | 50/60 (47 - 63)   |                   |               |               |        |
|                               | EFFICIENCY[%]                        | ACIN 100V   | 87typ             | 88typ         | 88typ         | 89typ  |
|                               |                                      | ACIN 200V   | 87typ             | 88typ         | 88typ         | 90typ  |
| INRUSH CURRENT                | Limited by external components       |   |                   |               |               |        |
| OUTPUT                        | VOLTAGE[V]                           | 5   | 12                | 15            | 24            |        |
|                               | CURRENT[A]                           | 5   | 2.1               | 1.7           | 1.1           |        |
|                               | LINE REGULATION[mV]                  | 20max   | 48max             | 60max         | 96max         |        |
|                               | LOAD REGULATION[mV]                  | 40max   | 100max            | 120max        | 150max        |        |
|                               | RIPPLE[mVp-p]                        | 30 to 100% Load *1  | 120max            | 160max        | 160max        | 200max |
|                               |                                      | 0 to 30% Load AC85V - 240V *1   | 400max            | 480max        | 480max        | 580max |
|                               | RIPPLE NOISE[mVp-p]                  | 30 to 100% Load *1  | 160max            | 200max        | 200max        | 240max |
|                               |                                      | 0 to 30% Load AC85V - 240V *1   | 480max            | 560max        | 560max        | 660max |
|                               | TEMPERATURE REGULATION[mV]           | 0 to +50°C  | 100max            | 180max        | 240max        | 360max |
|                               |                                      | -40 to +50°C  | 150max            | 270max        | 360max        | 480max |
| DRIFT[mV]                     | *2                                   | 20max   | 48max             | 60max         | 96max         |        |
| OUTPUT VOLTAGE SETTING[V]     |                                      | 4.90 - 5.30   | 11.40 - 12.60     | 14.25 - 15.75 | 23.00 - 25.00 |        |
| PROTECTION CIRCUIT AND OTHERS | OVERCURRENT PROTECTION               | Works over 105% of rating and recover automatically   |                   |               |               |        |
|                               | OVERVOLTAGE PROTECTION[V]            | 5.50 - 8.00   | 13.20 - 19.20     | 16.50 - 24.00 | 26.40 - 38.40 |        |
| ISOLATION                     | INPUT-OUTPUT                         | AC3,000V 1minute, Cutoff current = 10mA, DC500V 50MΩ min (20±15°C)                            |                   |               |               |        |
| ENVIRONMENT                   | OPERATING TEMP., HUMID. AND ALTITUDE | -40 to +85°C, 20 - 95%RH (Non condensing) (Refer to DERATING CURVE), 3,000m (10,000 feet) max |                   |               |               |        |
|                               | STORAGE TEMP., HUMID. AND ALTITUDE   | -40 to +100°C, 20 - 95%RH (Non condensing), 9,000m (30,000 feet) max                          |                   |               |               |        |
|                               | VIBRATION                            | 10 - 55Hz, 49.0m/s <sup>2</sup> (5G), 3minutes period, 60minutes each along X, Y and Z axis   |                   |               |               |        |
|                               | IMPACT                               | 196.1m/s <sup>2</sup> (20G), 11ms, once each along X, Y and Z axis                            |                   |               |               |        |
| SAFETY AND NOISE REGULATIONS  | AGENCY APPROVALS                     | UL60950-1, C-UL (CSA60950-1), EN60950-1   |                   |               |               |        |
|                               | CONDUCTED NOISE                      | Complies with FCC-B, VCCI-B, CISPR-B, EN55022-B *3  |                   |               |               |        |
|                               | HARMONIC ATTENUATOR                  | Complies with IEC61000-3-2 (Class A) (Not built-in to active filter)                          |                   |               |               |        |
| OTHERS                        | CASE SIZE/WEIGHT                     | 36.0 X 16.5 X 25.4mm [1.42 X 0.65 X 1.0 inches] (W X H X D) / 40g max                         |                   |               |               |        |
|                               | COOLING METHOD                       | Convection / Forced air   |                   |               |               |        |

\*1 Refer to instruction manual for measuring method of electric characteristics.  
 \*2 Drift is the change in DC output for an eight hour period after a half-hour warm-up at 25°C, with the input voltage held constant at the rated value.  
 \*3 Do not ground secondly circuit, in case of a standard adapted.  
 \* Measured with 120μF capacitor as Cbc.

External view

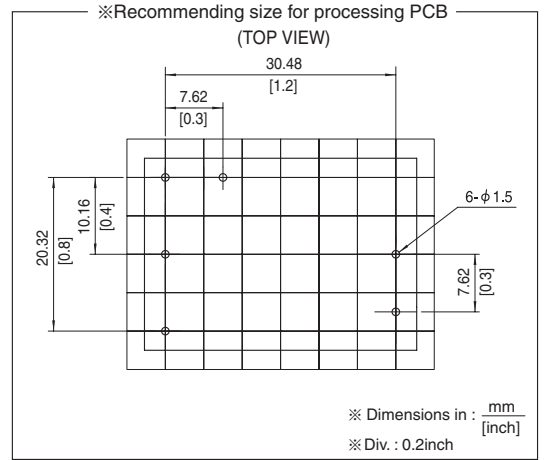
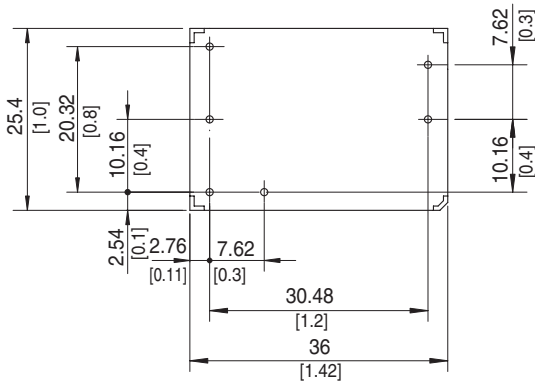
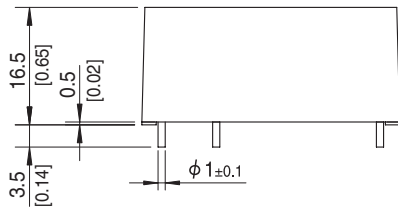
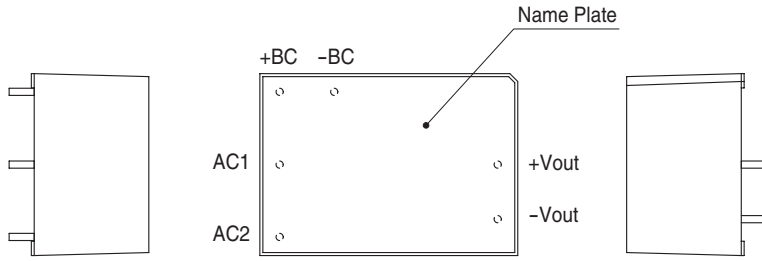

- ※ Tolerance :  $\pm 0.5$  [ $\pm 0.02$ ]
- ※ Weight : 40g max
- ※ Case material : PBT
- ※ Pin material : Copper
- ※ Plating treatment of pin : Lead free plating
- ※ Dimensions in mm, [ ]=inches

# Mouser Electronics

Authorized Distributor

Click to View Pricing, Inventory, Delivery & Lifecycle Information:

Cosel:

[TUHS10F15](#) [TUHS15F15](#) [TUHS25F15](#) [TUHS3F15](#) [TUHS5F15](#)



Компания «ЭлектроПласт» предлагает заключение долгосрочных отношений при поставках импортных электронных компонентов на взаимовыгодных условиях!

Наши преимущества:

- Оперативные поставки широкого спектра электронных компонентов отечественного и импортного производства напрямую от производителей и с крупнейших мировых складов;
- Поставка более 17-ти миллионов наименований электронных компонентов;
- Поставка сложных, дефицитных, либо снятых с производства позиций;
- Оперативные сроки поставки под заказ (от 5 рабочих дней);
- Экспресс доставка в любую точку России;
- Техническая поддержка проекта, помощь в подборе аналогов, поставка прототипов;
- Система менеджмента качества сертифицирована по Международному стандарту ISO 9001;
- Лицензия ФСБ на осуществление работ с использованием сведений, составляющих государственную тайну;
- Поставка специализированных компонентов (Xilinx, Altera, Analog Devices, Intersil, Interpoint, Microsemi, Aeroflex, Peregrine, Syfer, Eurofarad, Texas Instrument, Miteq, Cobham, E2V, MA-COM, Hittite, Mini-Circuits, General Dynamics и др.);

Помимо этого, одним из направлений компании «ЭлектроПласт» является направление «Источники питания». Мы предлагаем Вам помощь Конструкторского отдела:

- Подбор оптимального решения, техническое обоснование при выборе компонента;
- Подбор аналогов;
- Консультации по применению компонента;
- Поставка образцов и прототипов;
- Техническая поддержка проекта;
- Защита от снятия компонента с производства.



#### Как с нами связаться

**Телефон:** 8 (812) 309 58 32 (многоканальный)

**Факс:** 8 (812) 320-02-42

**Электронная почта:** [org@eplast1.ru](mailto:org@eplast1.ru)

**Адрес:** 198099, г. Санкт-Петербург, ул. Калинина, дом 2, корпус 4, литера А.