

# SUBMINIATURE BASIC SWITCHES

**B2**  
BASIC SWITCHES

SINGLE BREAK, SNAP-ACTION, COMMERCIAL & MILITARY GRADES, SUBMINIATURE, TWO WIDTHS

Available in two widths, the B2 series can be specified to fit your application exactly.

In addition to being available with integral actuating levers as in the B2-5 series, the B2 series is also available with the A1 series auxiliary lever actuators as shown in the B3 section.

While the B2 series conforms to and is qualified to various military specifications, the same switch can be specified for commercial use at a cost savings.

A choice of turret, quick connect and three lengths of printed circuit board style terminals are available for both the 0.156" and 0.200" wide models.

Whether it be military or commercial applications, OTTO can provide features you select for your application. You can specify the features you require without paying for ones you don't need.

The OTTO B2 subminiature switches conform to and are qualified under MIL-PRF-8805/4, MIL-PRF-8805/106 (high temp -55°C to +205°C) and MIL-PRF-8805/109. Basic switches are designed for miniature spaces where cam or other limit actuators are used on the button. In addition, a full range of toggle, pushbutton and lever actuators are available.

## Features:

- Choice of 0.156" & 0.200" wide models
- Up to 7 amps switching
- Sensitive movement differentials
- Low operating forces
- Choice of 8 terminal styles or wire leads
- Long operating life
- Qualified under MIL-PRF-8805/4, MIL-PRF-8805/106 & MIL-PRF-8805/109
- UL recognized & CSA certified
- RoHS/WEEE/Reach compliant

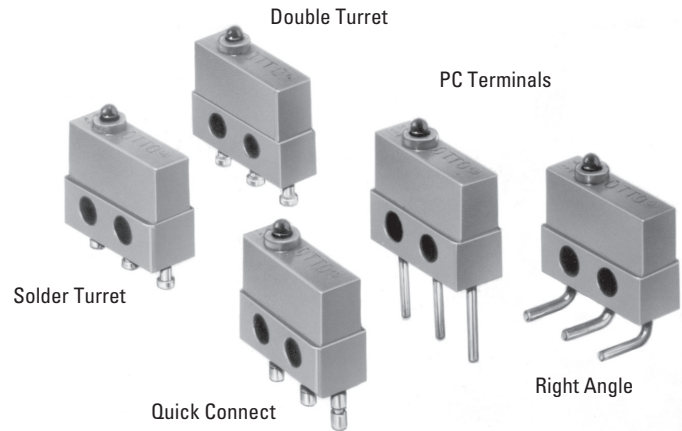

### Standard Characteristics/Ratings:

#### ELECTRICAL RATINGS:

High Level Switch Ratings		
Load	Rating – Sea Level	Rating – 50,000 feet
<b>115VAC, 60Hz silver contacts with gold plate</b>		
Resistive	7A	N/A
Inductive	7A	N/A
Lamp	2A	N/A
<b>28VDC, silver contacts with gold plate</b>		
Resistive	7A	4A
Inductive	4A	2.5A
Lamp	2.5A	2.5A
Low Level Switch Ratings		
<b>28VDC, gold plate contacts</b>		
Resistive	1A	1A
Inductive	0.5A	0.5A
Lamp	N/A	N/A
<b>DWV:</b>	1000Vrms	400Vrms
<b>Electrical Life:</b>	25,000 to 100,000 cycles (dependent on part number)	
<b>Mechanical Life:</b>	50,000 to 250,000 cycles (dependent on part number)	
<b>Seal:</b>	Unsealed	
<b>Operating Temp Range:</b>	-55°C to +85°C, high temp rating -55°C to +205°C	
<b>Operating Force:</b>	5 oz or 6 oz	
<b>Release Force:</b>	1 oz min	
<b>Operate Point:</b>	0.320 +/- 0.015 inches from mounting holes	
<b>Overtravel:</b>	0.004 inches min	
<b>Movement Differential:</b>	0.006 inches max	
<b>Pretravel:</b>	0.020 inches max	
<b>MATERIALS:</b>		
<b>Case:</b>	Thermoset, blue	
<b>Cover:</b>	Thermoplastic, blue	
<b>Button:</b>	Thermoplastic, black	
<b>Terminals:</b>	Brass, gold over nickel	
<b>Contacts:</b>	Stationary: Silver with gold Moveable: Silver or gold	
<b>Terminal Hardware:</b>	None provided	
<b>Optional Wires:</b>	24 AWG blue, red, yellow	
<b>Mounting Hardware:</b>	None provided	

### Auxiliary Lever Actuators for B2

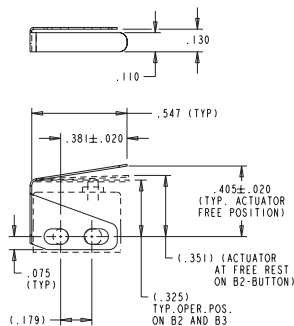
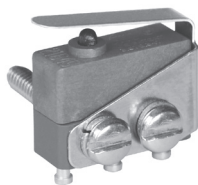

A1-101-02 Shown

Catalog Number	Number of Poles
A1-115-01	1
A2-109	2

Supplied with two 2-56 panhead screws, hex nuts and lockwashers.

For additional options, contact factory.

SINGLE BREAK, SNAP-ACTION, COMMERCIAL & MILITARY GRADES, SUBMINIATURE, TWO WIDTHS

**MILITARY APPROVALS**

(MIL-PRF-8805/4, MIL-PRF-8805/106 & MIL-PRF-8805/109)

Certain OTTO B2 models have been qualified to the military specification for these parts. The following is the latest listing.

MILITARY NO.	OTTO P/N
M8805/106-01	B2-200031
M8805/106-02	B2-200032
M8805/109-01	B2-111351
M8805/109-02	B2-112351
M8805/109-03	B2-111353
M8805/109-04	B2-112353
MS24547-1 (M8805/4)	B2-211351
MS24547-2 (M8805/4)	B2-211353
MS24547-4 (M8805/4)	B2-212351
MS24547-5 (M8805/4)	B2-212353
MS24547-6 (M8805/4)	B2-200029
MS24547-7 (M8805/4)	B2-200030

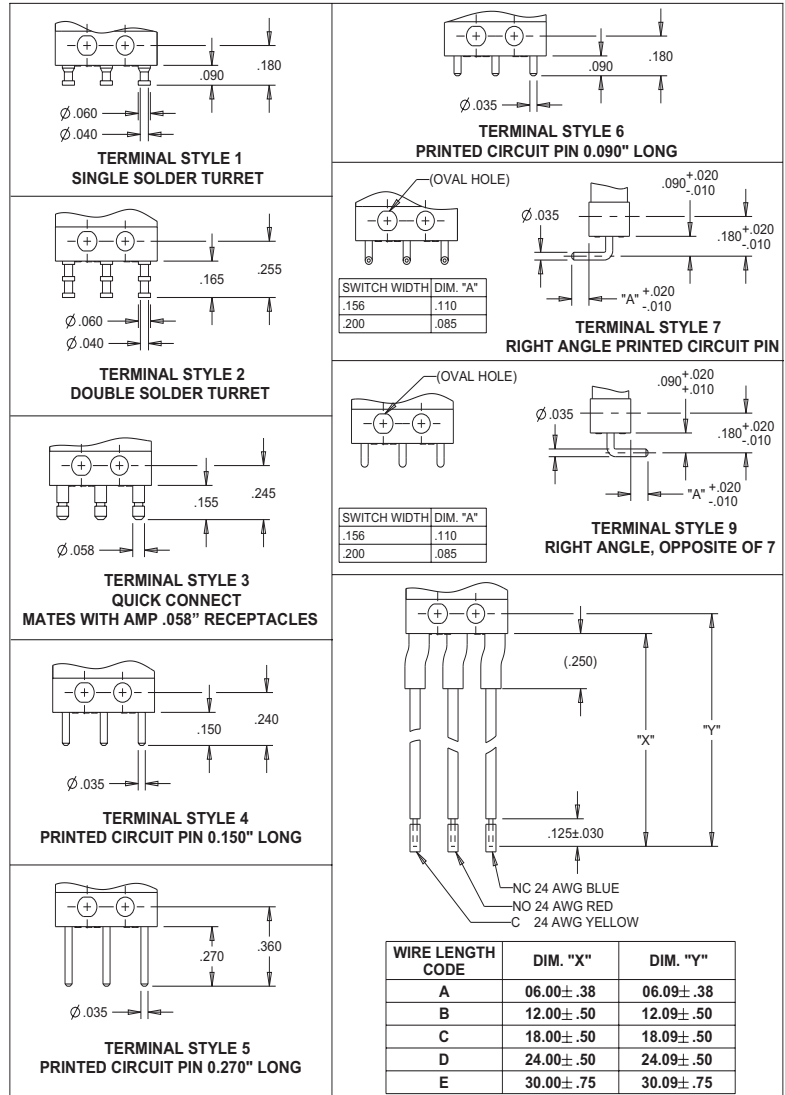

**ORDERING INFORMATION:**

Select the OTTO B2 basic switch to match your specific circuit and mechanical requirements. To order, specify your requirement using the OTTO Part Number Code shown to the right.

**Example:** B2-112351 specifies Military grade construction on a 0.156" wide base, double turret terminals, 5 oz operating force, 0.005" movement differential and silver/gold high current contacts.

**B2 PART NUMBER CODE**

Bold Code numbers signify standard features with best availability.

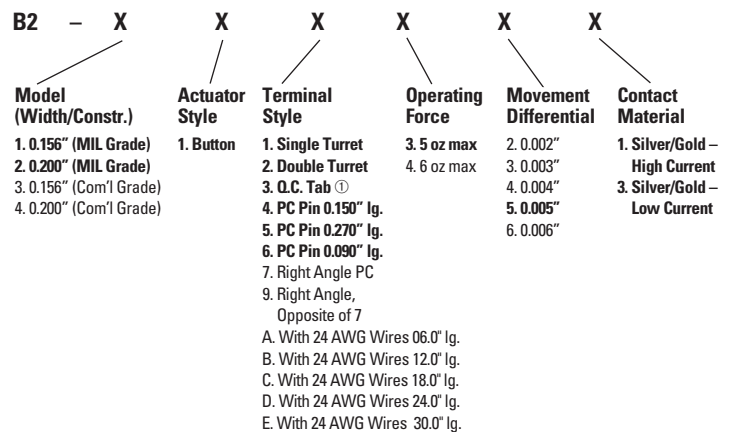

① Mates with AMP 0.058" receptacles.

# SUBMINIATURE BASIC SWITCHES

SINGLE BREAK, SNAP-ACTION, COMMERCIAL & MILITARY GRADES, SUBMINIATURE, TWO WIDTHS

BASIC SWITCH  
APPLIES TO ALL SWITCHES ON THIS PAGE

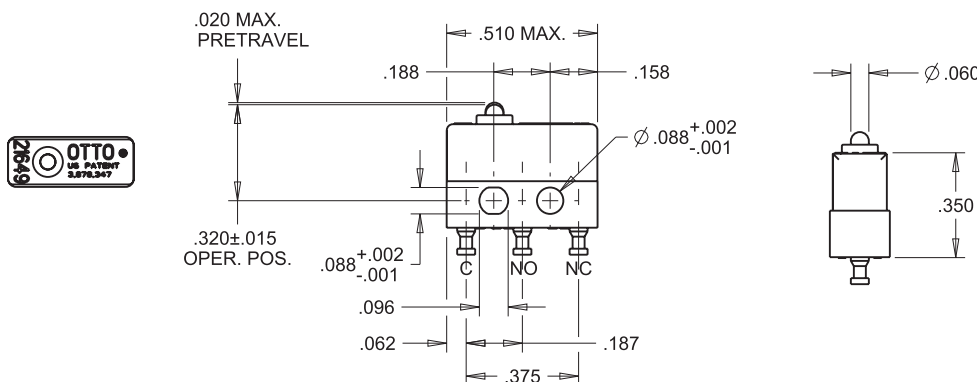

MODEL (WIDTH/CONSTRUCTION) 1  
0.156" (MILITARY GRADE)



MILITARY NO.	OTTO P/N
M8805/109-01	B2-111351
M8805/109-02	B2-112351
M8805/109-03	B2-111353
M8805/109-04	B2-112353

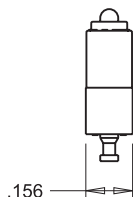
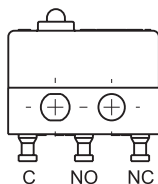

MODEL (WIDTH/CONSTRUCTION) 3  
0.156" (COMMERCIAL GRADE)

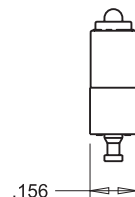
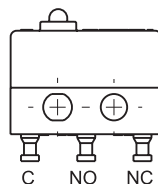

MODEL (WIDTH/CONSTRUCTION) 2  
0.200" (MILITARY GRADE)



MILITARY NO.	OTTO P/N
MS24547-1 (M8805/4)	B2-211351
MS24547-4 (M8805/4)	B2-212351
MS24547-2 (M8805/4)	B2-211353
MS24547-5 (M8805/4)	B2-212353

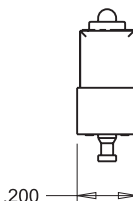
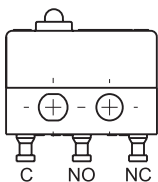

MODEL (WIDTH/CONSTRUCTION) 4  
0.200" (COMMERCIAL GRADE)

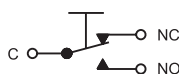
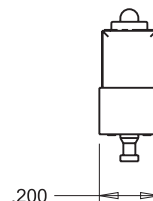
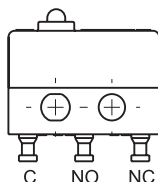

SPDT-FORM C  
SCHEMATIC



Компания «ЭлектроПласт» предлагает заключение долгосрочных отношений при поставках импортных электронных компонентов на взаимовыгодных условиях!

Наши преимущества:

- Оперативные поставки широкого спектра электронных компонентов отечественного и импортного производства напрямую от производителей и с крупнейших мировых складов;
- Поставка более 17-ти миллионов наименований электронных компонентов;
- Поставка сложных, дефицитных, либо снятых с производства позиций;
- Оперативные сроки поставки под заказ (от 5 рабочих дней);
- Экспресс доставка в любую точку России;
- Техническая поддержка проекта, помощь в подборе аналогов, поставка прототипов;
- Система менеджмента качества сертифицирована по Международному стандарту ISO 9001;
- Лицензия ФСБ на осуществление работ с использованием сведений, составляющих государственную тайну;
- Поставка специализированных компонентов (Xilinx, Altera, Analog Devices, Intersil, Interpoint, Microsemi, Aeroflex, Peregrine, Syfer, Eurofarad, Texas Instrument, Miteq, Cobham, E2V, MA-COM, Hittite, Mini-Circuits, General Dynamics и др.);

Помимо этого, одним из направлений компании «ЭлектроПласт» является направление «Источники питания». Мы предлагаем Вам помощь Конструкторского отдела:

- Подбор оптимального решения, техническое обоснование при выборе компонента;
- Подбор аналогов;
- Консультации по применению компонента;
- Поставка образцов и прототипов;
- Техническая поддержка проекта;
- Защита от снятия компонента с производства.



#### Как с нами связаться

**Телефон:** 8 (812) 309 58 32 (многоканальный)

**Факс:** 8 (812) 320-02-42

**Электронная почта:** [org@eplast1.ru](mailto:org@eplast1.ru)

**Адрес:** 198099, г. Санкт-Петербург, ул. Калинина, дом 2, корпус 4, литера А.