

2N6284 (NPN); 2N6286, 2N6287 (PNP)

Preferred Device

Darlington Complementary Silicon Power Transistors

These packages are designed for general-purpose amplifier and low-frequency switching applications.

Features

- High DC Current Gain @ $I_C = 10 \text{ Adc}$ –
 $h_{FE} = 2400 \text{ (Typ)} - 2N6284$
 $= 4000 \text{ (Typ)} - 2N6287$
- Collector–Emitter Sustaining Voltage –
 $V_{CEO(sus)} = 100 \text{ Vdc (Min)}$
- Monolithic Construction with Built–In Base–Emitter Shunt Resistors
- Pb–Free Packages are Available*

MAXIMUM RATINGS (Note 1)

| Rating | Symbol | Value | Unit |
|---|----------------|--------------|--------------------------|
| Collector–Emitter Voltage 2N6286 2N6284/87 | V_{CEO} | 80 100 | Vdc |
| Collector–Base Voltage 2N6286 2N6284/87 | V_{CB} | 80 100 | Vdc |
| Emitter–Base Voltage | V_{EB} | 5.0 | Vdc |
| Collector Current – Continuous Peak | I_C | 20 40 | Adc |
| Base Current | I_B | 0.5 | Adc |
| Total Power Dissipation @ $T_C = 25^\circ\text{C}$ Derate above 25°C | P_D | 160 0.915 | W W/ $^\circ\text{C}$ |
| Operating and Storage Temperature Range | T_J, T_{stg} | –65 to +200 | $^\circ\text{C}$ |

THERMAL CHARACTERISTICS (Note 1)

| Characteristic | Symbol | Max | Unit |
|--------------------------------------|-----------------|------|--------------------|
| Thermal Resistance, Junction–to–Case | $R_{\theta JC}$ | 1.09 | $^\circ\text{C/W}$ |

Stresses exceeding Maximum Ratings may damage the device. Maximum Ratings are stress ratings only. Functional operation above the Recommended Operating Conditions is not implied. Extended exposure to stresses above the Recommended Operating Conditions may affect device reliability.

1. Indicates JEDEC Registered Data.

*For additional information on our Pb–Free strategy and soldering details, please download the ON Semiconductor Soldering and Mounting Techniques Reference Manual, SOLDERRM/D.



ON Semiconductor®

<http://onsemi.com>

20 AMPERE COMPLEMENTARY SILICON POWER TRANSISTORS 100 VOLTS, 160 WATTS



TO–204AA (TO–3)
CASE 1–07
STYLE 1

MARKING DIAGRAM



2N628x = Device Code
 $x = 4, 6 \text{ or } 7$
 G = Pb–Free Package
 A = Location Code
 YY = Year
 WW = Work Week
 MEX = Country of Origin

ORDERING INFORMATION

| Device | Package | Shipping |
|---------|-------------------|----------------|
| 2N6284 | TO–3 | 100 Units/Tray |
| 2N6284G | TO–3 (Pb–Free) | 100 Units/Tray |
| 2N6286 | TO–3 | 100 Units/Tray |
| 2N6286G | TO–3 (Pb–Free) | 100 Units/Tray |
| 2N6287 | TO–3 | 100 Units/Tray |
| 2N6287G | TO–3 (Pb–Free) | 100 Units/Tray |

2N6284 (NPN); 2N6286, 2N6287 (PNP)



Figure 1. Power Derating

ELECTRICAL CHARACTERISTICS (T_C = 25°C unless otherwise noted) (Note 2)

| Characteristic | Symbol | Min | Max | Unit |
|--|-----------------------|-----|-----|------|
| OFF CHARACTERISTICS | | | | |
| Collector–Emitter Sustaining Voltage (I _C = 0.1 Adc, I _B = 0) | V _{CEO(sus)} | 80 | – | Vdc |
| 2N6286 2N6284, 2N6287 | | 100 | – | |
| Collector Cutoff Current (V _{CE} = 40 Vdc, I _B = 0) | I _{CEO} | – | 1.0 | mAdc |
| (V _{CE} = 50 Vdc, I _B = 0) | | – | 1.0 | |
| Collector Cutoff Current (V _{CE} = Rated V _{CB} , V _{BE(off)} = 1.5 Vdc) | I _{CEX} | – | 0.5 | mAdc |
| (V _{CE} = Rated V _{CB} , V _{BE(off)} = 1.5 Vdc, T _C = 150°C) | | – | 5.0 | |
| Emitter Cutoff Current (V _{BE} = 5.0 Vdc, I _C = 0) | I _{EBO} | – | 2.0 | mAdc |

ON CHARACTERISTICS (Note 3)

| | | | | |
|---|----------------------|-----|--------|-----|
| DC Current Gain (I _C = 10 Adc, V _{CE} = 3.0 Vdc) | h _{FE} | 750 | 18,000 | – |
| (I _C = 20 Adc, V _{CE} = 3.0 Vdc) | | 100 | – | |
| Collector–Emitter Saturation Voltage (I _C = 10 Adc, I _B = 40 mAdc) | V _{CE(sat)} | – | 2.0 | Vdc |
| (I _C = 20 Adc, I _B = 200 mAdc) | | – | 3.0 | |
| Base–Emitter On Voltage (I _C = 10 Adc, V _{CE} = 3.0 Vdc) | V _{BE(on)} | – | 2.8 | Vdc |
| Base–Emitter Saturation Voltage (I _C = 20 Adc, I _B = 200 mAdc) | V _{BE(sat)} | – | 4.0 | Vdc |

DYNAMIC CHARACTERISTICS

| | | | | |
|--|-----------------|-----|-----|-----|
| Magnitude of Common Emitter Small–Signal Short–Circuit Forward Current Transfer Ratio (I _C = 10 Adc, V _{CE} = 3.0 Vdc, f = 1.0 MHz) | h _{fe} | 4.0 | – | MHz |
| Output Capacitance (V _{CB} = 10 Vdc, I _E = 0, f = 0.1 MHz) | C _{ob} | – | 400 | pF |
| 2N6284 2N6286, 2N6287 | | – | 600 | |
| Small–Signal Current Gain (I _C = 10 Adc, V _{CE} = 3.0 Vdc, f = 1.0 kHz) | h _{fe} | 300 | – | – |

2. Indicates JEDEC Registered Data.
3. Pulse test: Pulse Width = 300 μs, Duty Cycle = 2%

2N6284 (NPN); 2N6286, 2N6287 (PNP)

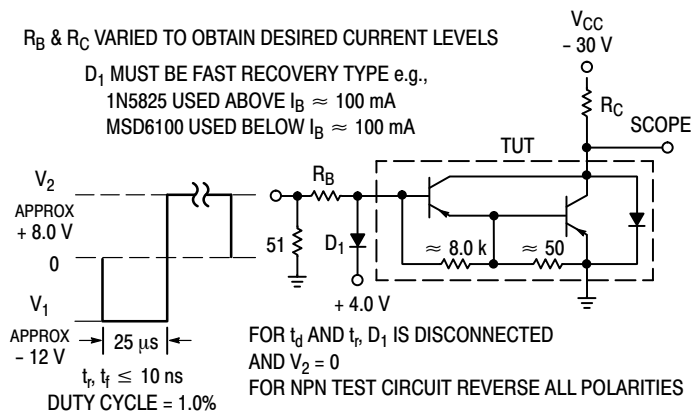

Figure 2. Switching Times Test Circuit

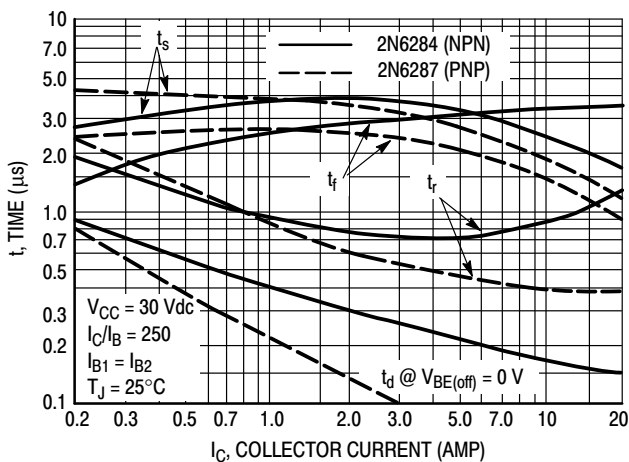

Figure 3. Switching Times

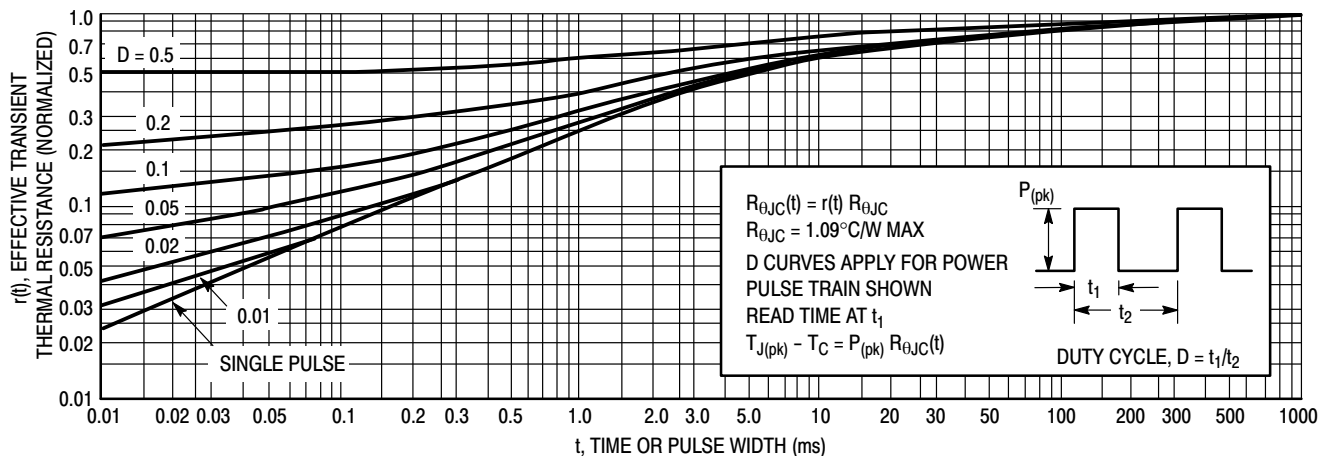

Figure 4. Thermal Response

2N6284 (NPN); 2N6286, 2N6287 (PNP)

ACTIVE-REGION SAFE OPERATING AREA



Figure 5. 2N6284, 2N6287

There are two limitations on the power handling ability of a transistor: average junction temperature and second breakdown. Safe operating area curves indicate $I_C - V_{CE}$ limits of the transistor that must be observed for reliable operation; i.e. the transistor must not be subjected to greater dissipation than the curves indicate.

The data of Figure 5 is based on $T_{J(pk)} = 200^\circ\text{C}$; T_C is variable depending on conditions. Second breakdown pulse limits are valid for duty cycles to 10% provided $T_{J(pk)} < 200^\circ\text{C}$. $T_{J(pk)}$ may be calculated from the data in Figure 4. At high case temperatures, thermal limitations will reduce the power that can be handled to values less than the limitations imposed by second breakdown.

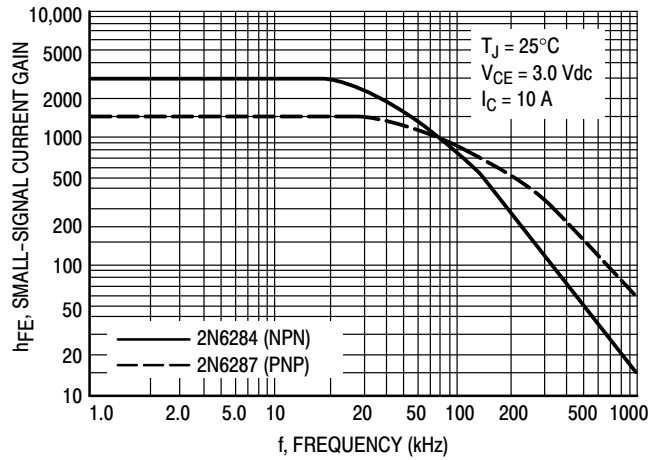

Figure 6. Small-Signal Current Gain

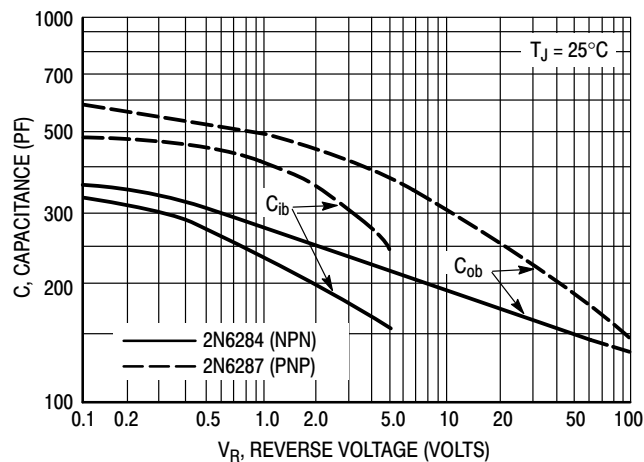

Figure 7. Capacitance

2N6284 (NPN); 2N6286, 2N6287 (PNP)

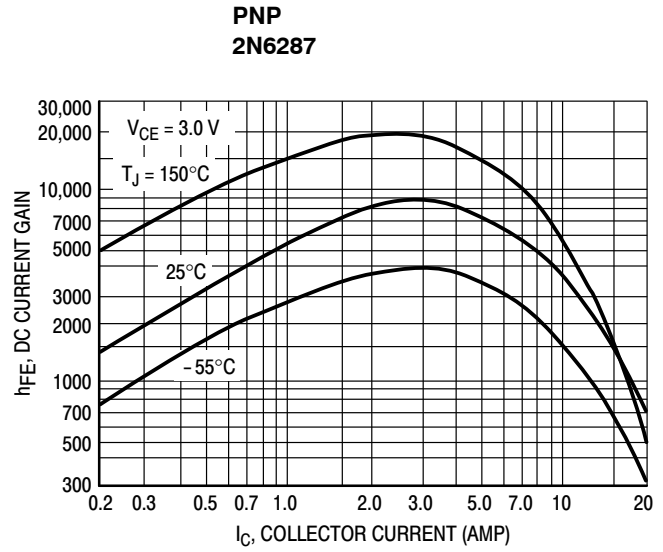
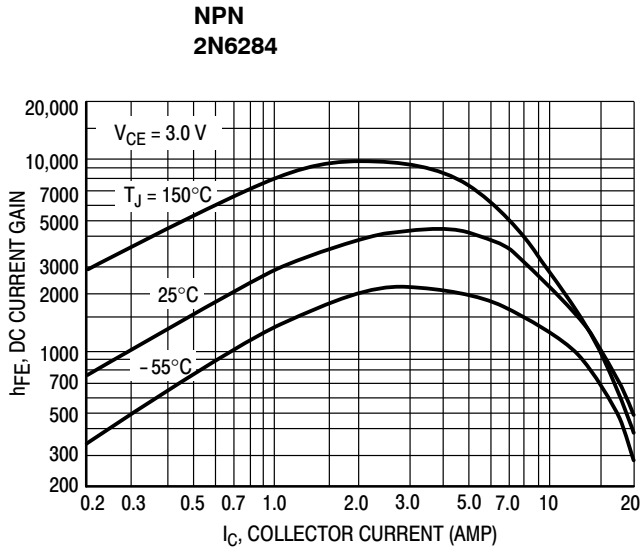

Figure 8. DC Current Gain

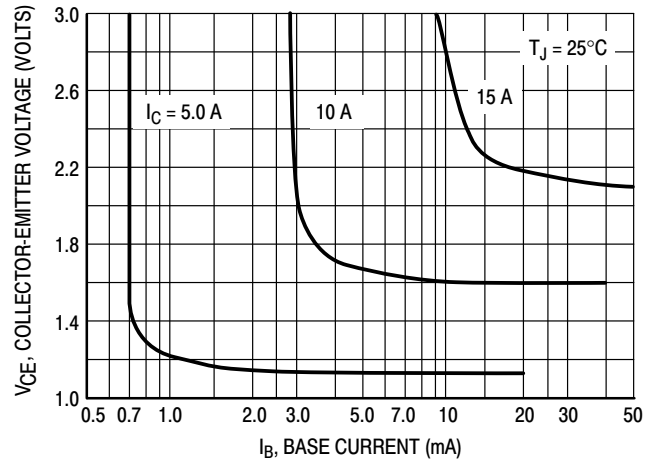
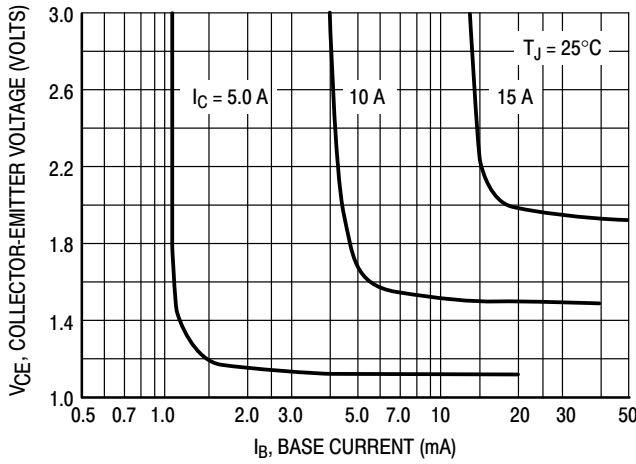

Figure 9. Collector Saturation Region

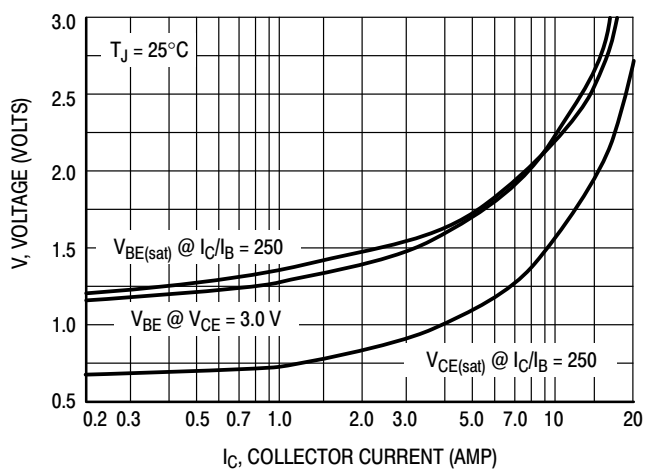
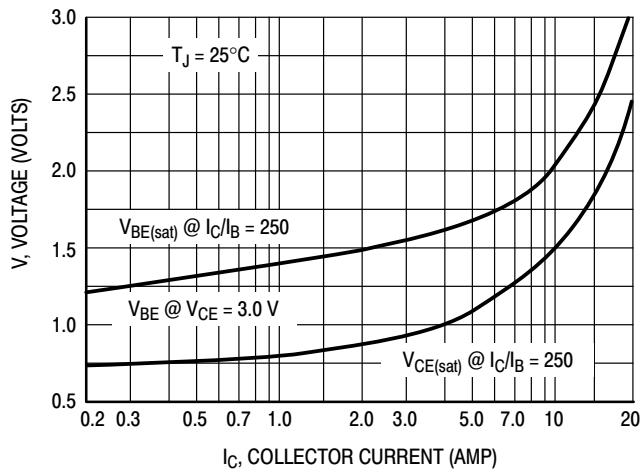

Figure 10. "On" Voltages

2N6284 (NPN); 2N6286, 2N6287 (PNP)

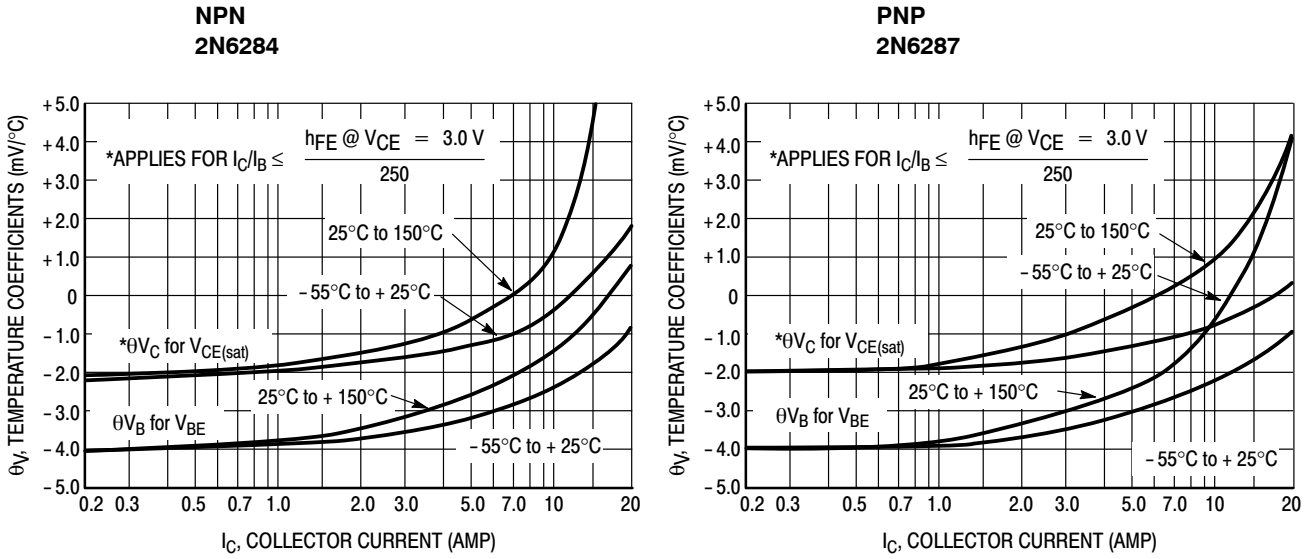

Figure 11. Temperature Coefficients

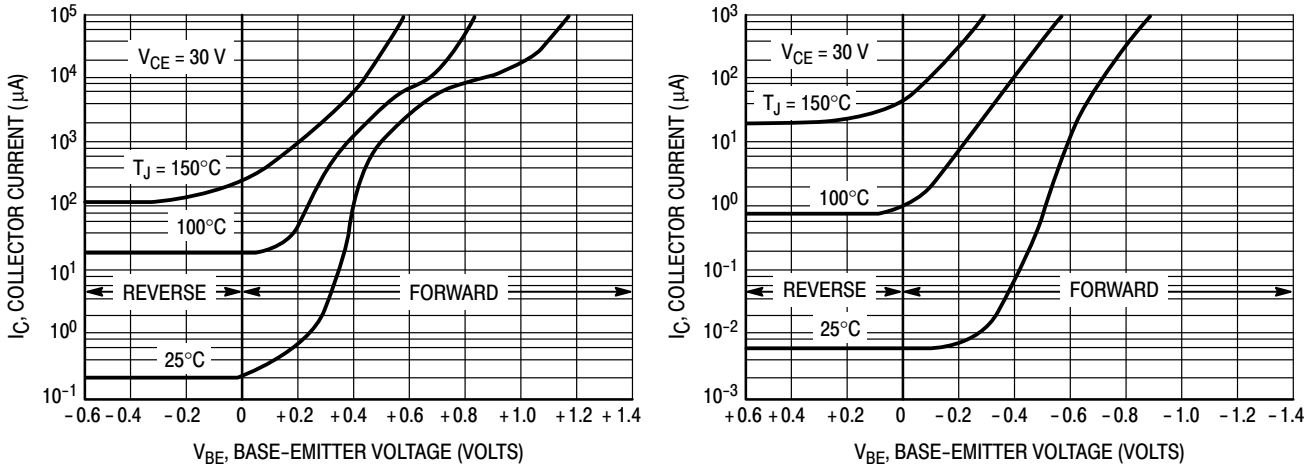

Figure 12. Collector Cut-Off Region

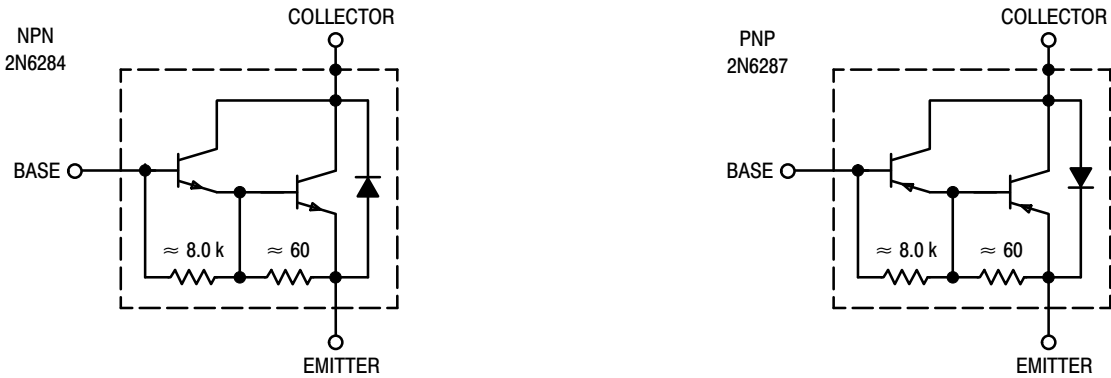
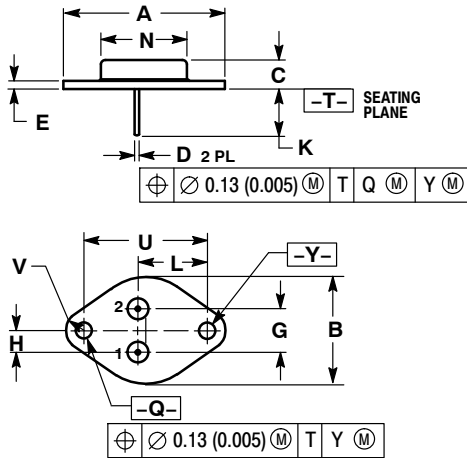

Figure 13. Darlington Schematic

2N6284 (NPN); 2N6286, 2N6287 (PNP)

PACKAGE DIMENSIONS

TO-204 (TO-3)
CASE 1-07
ISSUE Z



NOTES:

1. DIMENSIONING AND TOLERANCING PER ANSI Y14.5M, 1982.
2. CONTROLLING DIMENSION: INCH.
3. ALL RULES AND NOTES ASSOCIATED WITH REFERENCED TO-204AA OUTLINE SHALL APPLY.

| DIM | INCHES | | MILLIMETERS | |
|-----|-----------|-------|-------------|-------|
| | MIN | MAX | MIN | MAX |
| A | 1.550 REF | | 39.37 REF | |
| B | --- | 1.050 | --- | 26.67 |
| C | 0.250 | 0.335 | 6.35 | 8.51 |
| D | 0.038 | 0.043 | 0.97 | 1.09 |
| E | 0.055 | 0.070 | 1.40 | 1.77 |
| G | 0.430 BSC | | 10.92 BSC | |
| H | 0.215 BSC | | 5.46 BSC | |
| K | 0.440 | 0.480 | 11.18 | 12.19 |
| L | 0.665 BSC | | 16.89 BSC | |
| N | --- | 0.830 | --- | 21.08 |
| Q | 0.151 | 0.165 | 3.84 | 4.19 |
| U | 1.187 BSC | | 30.15 BSC | |
| V | 0.131 | 0.188 | 3.33 | 4.77 |

STYLE 1:

- PIN 1. BASE
 - EMITTER
- CASE: COLLECTOR

ON Semiconductor and are registered trademarks of Semiconductor Components Industries, LLC (SCILLC). SCILLC reserves the right to make changes without further notice to any products herein. SCILLC makes no warranty, representation or guarantee regarding the suitability of its products for any particular purpose, nor does SCILLC assume any liability arising out of the application or use of any product or circuit, and specifically disclaims any and all liability, including without limitation special, consequential or incidental damages. "Typical" parameters which may be provided in SCILLC data sheets and/or specifications can and do vary in different applications and actual performance may vary over time. All operating parameters, including "Typicals" must be validated for each customer application by customer's technical experts. SCILLC does not convey any license under its patent rights nor the rights of others. SCILLC products are not designed, intended, or authorized for use as components in systems intended for surgical implant into the body, or other applications intended to support or sustain life, or for any other application in which the failure of the SCILLC product could create a situation where personal injury or death may occur. Should Buyer purchase or use SCILLC products for any such unintended or unauthorized application, Buyer shall indemnify and hold SCILLC and its officers, employees, subsidiaries, affiliates, and distributors harmless against all claims, costs, damages, and expenses, and reasonable attorney fees arising out of, directly or indirectly, any claim of personal injury or death associated with such unintended or unauthorized use, even if such claim alleges that SCILLC was negligent regarding the design or manufacture of the part. SCILLC is an Equal Opportunity/Affirmative Action Employer. This literature is subject to all applicable copyright laws and is not for resale in any manner.

PUBLICATION ORDERING INFORMATION

LITERATURE FULFILLMENT:
Literature Distribution Center for ON Semiconductor
P.O. Box 5163, Denver, Colorado 80217 USA
Phone: 303-675-2175 or 800-344-3860 Toll Free USA/Canada
Fax: 303-675-2176 or 800-344-3867 Toll Free USA/Canada
Email: orderlit@onsemi.com

N. American Technical Support: 800-282-9855 Toll Free
USA/Canada
Europe, Middle East and Africa Technical Support:
Phone: 421 33 790 2910
Japan Customer Focus Center
Phone: 81-3-5773-3850

ON Semiconductor Website: www.onsemi.com
Order Literature: <http://www.onsemi.com/orderlit>
For additional information, please contact your local Sales Representative



Компания «ЭлектроПласт» предлагает заключение долгосрочных отношений при поставках импортных электронных компонентов на взаимовыгодных условиях!

Наши преимущества:

- Оперативные поставки широкого спектра электронных компонентов отечественного и импортного производства напрямую от производителей и с крупнейших мировых складов;
- Поставка более 17-ти миллионов наименований электронных компонентов;
- Поставка сложных, дефицитных, либо снятых с производства позиций;
- Оперативные сроки поставки под заказ (от 5 рабочих дней);
- Экспресс доставка в любую точку России;
- Техническая поддержка проекта, помощь в подборе аналогов, поставка прототипов;
- Система менеджмента качества сертифицирована по Международному стандарту ISO 9001;
- Лицензия ФСБ на осуществление работ с использованием сведений, составляющих государственную тайну;
- Поставка специализированных компонентов (Xilinx, Altera, Analog Devices, Intersil, Interpoint, Microsemi, Aeroflex, Peregrine, Syfer, Eurofarad, Texas Instrument, Miteq, Cobham, E2V, MA-COM, Hittite, Mini-Circuits, General Dynamics и др.);

Помимо этого, одним из направлений компании «ЭлектроПласт» является направление «Источники питания». Мы предлагаем Вам помощь Конструкторского отдела:

- Подбор оптимального решения, техническое обоснование при выборе компонента;
- Подбор аналогов;
- Консультации по применению компонента;
- Поставка образцов и прототипов;
- Техническая поддержка проекта;
- Защита от снятия компонента с производства.



Как с нами связаться

Телефон: 8 (812) 309 58 32 (многоканальный)

Факс: 8 (812) 320-02-42

Электронная почта: org@eplast1.ru

Адрес: 198099, г. Санкт-Петербург, ул. Калинина, дом 2, корпус 4, литера А.