

# E2EH

CSM\_E2EH\_DS\_E\_4\_2

## Proximity Sensor Ideal for the Food and Beverage Industry



–SUS316L Body, IP69K Protection, Resistant to High Temperatures and Detergents–



Improved resistance to detergents and rusting



Applicable to 120°C (with DC 3-wire connection) (Heat resistance verified to 1,000 hours.)



Resists typical detergents and disinfectants used in the food industry



Water resistant under high-temperature, high-pressure cleaning based on DIN 40050-9. (Pressure: 8,000 to 10,000 kPa, Water temperature: 80°C, For 30 s at all angles)



For the most recent information on models that have been certified for safety standards, refer to your OMRON website.

Be sure to read *Safety Precautions* on page 9.

## Ordering Information

**Sensors** [Refer to *Dimensions* on page 10.]

**Pre-wired Models**

Appearance	Sensing distance	Output configuration	Operation mode: NO	Operation mode: NC
Shielded 	M12 3 mm	DC 2-wire (polarity)	E2EH-X3D1 2M	E2EH-X3D2 2M
		DC 2-wire (no polarity) *	E2EH-X3D1-T 2M	---
		DC 3-wire (PNP)	E2EH-X3B1 2M	E2EH-X3B2 2M
		DC 3-wire (NPN)	E2EH-X3C1 2M	E2EH-X3C2 2M
	M18 7 mm	DC 2-wire (polarity)	E2EH-X7D1 2M	E2EH-X7D2 2M
		DC 2-wire (no polarity) *	E2EH-X7D1-T 2M	---
		DC 3-wire (PNP)	E2EH-X7B1 2M	E2EH-X7B2 2M
		DC 3-wire (NPN)	E2EH-X7C1 2M	E2EH-X7C2 2M
	M30 12 mm	DC 2-wire (polarity)	E2EH-X12D1 2M	E2EH-X12D2 2M
		DC 2-wire (no polarity) *	E2EH-X12D1-T 2M	---
		DC 3-wire (PNP)	E2EH-X12B1 2M	E2EH-X12B2 2M
		DC 3-wire (NPN)	E2EH-X12C1 2M	E2EH-X12C2 2M

### Connector Models (M12)



Appearance	Sensing distance	Output configuration	Operation mode: NO	Operation mode: NC
Shielded 	M12 3 mm	DC 2-wire (polarity)	E2EH-X3D1-M1G	E2EH-X3D2-M1G
		DC 3-wire (PNP)	E2EH-X3B1-M1	E2EH-X3B2-M1
		DC 3-wire (NPN)	E2EH-X3C1-M1	E2EH-X3C2-M1
	M18 7 mm	DC 2-wire (polarity)	E2EH-X7D1-M1G	E2EH-X7D2-M1G
		DC 3-wire (PNP)	E2EH-X7B1-M1	E2EH-X7B2-M1
		DC 3-wire (NPN)	E2EH-X7C1-M1	E2EH-X7C2-M1
	M30 12 mm	DC 2-wire (polarity)	E2EH-X12D1-M1G	E2EH-X12D2-M1G
		DC 3-wire (PNP)	E2EH-X12B1-M1	E2EH-X12B2-M1
		DC 3-wire (NPN)	E2EH-X12C1-M1	E2EH-X12C2-M1

\*When using a no-polarity model, there is no need to be concerned about whether to connect to the positive or negative side of the power supply. The load can be connected to either the +V side or 0 V side.

## Accessories (Order Separately)

### Sensor I/O Connectors (M12, Sockets on One Cable End)

(Models for Connectors: A Connector is not provided with the Sensor. Be sure to order a Connector separately.) **[Refer to XS2.]**

Appearance	Cable length	Sensor I/O Connector model	Applicable Proximity Sensors
Straight 	2 m	XS2F-E421-D80-E	E2EH-X□D□-M1G E2EH-X□B□-M1 E2EH-X□C□-M1
	5 m	XS2F-E421-G80-E	
L-shape 	2 m	XS2F-E422-D80-E	
	5 m	XS2F-E422-G80-E	

Note: The above Connectors conform to DIN40050-9 standard, provide IP69K protection, have a maximum operating temperature of 105°C, and use SUS316L stainless steel.

## Ratings and Specifications

### E2EH-X□D□ DC 2-Wire Models

Item	Size Shielded Model	M12	M18	M30
		Shielded		
		E2EH-X3D□	E2EH-X7D□	E2EH-X12D□
Sensing distance		3 mm	7 mm	12 mm
Set distance *1		0 to 2.4 mm	0 to 5.6 mm	0 to 9.6 mm
Differential travel		15% max. of sensing distance		
Detectable object		Ferrous metal (The sensing distance decreases with non-ferrous metal. Refer to <i>Engineering Data</i> on page 6.)		
Standard sensing object		Iron, 12 × 12 × 1 mm	Iron 21 × 21 × 1 mm	Iron 36 × 36 × 1 mm
Response frequency *2		500 Hz	300 Hz	100 Hz
Power supply voltage (operating voltage range)		12 to 24 VDC, ripple (p-p): 10% max. (10 to 32 VDC, however, 24 VDC max. at temperatures over 100°C)		
Leakage current		0.8 mA max.		
Control output	Load current	3 to 100 mA (however, 3 to 50 mA at 100 to 110°C)		
	Residual voltage *3	Polarity Models: 3 V max. No polarity Models: E2EH-X□D□-T: (5 V max. *3 (Load current: 100 mA, Cable length 2 m)		
Indicators		D1 Models: Operation indicator (red), Setting indicator (yellow) D2 Models: Operation indicator (yellow)		
Operation mode (with sensing object approaching)		D1 Models: NO      Refer to the timing charts under <i>I/O Circuit Diagrams</i> on page 7 for details. D2 Models: NC		
Protection circuits		Surge suppressor, Load short-circuit protection		
Ambient temperature range		Operating: 0 to 100°C (0 to 110°C 1,000 h) *4 Storage: -25 to 70° (with no icing or condensation)		
Ambient humidity range		35% to 95%		
Temperature influence		±10% max. of sensing distance at 23°C in the temperature range of 0 to 70°C. ±15% max. of sensing distance at 23°C in the temperature range of 70 to 100°C. -15% to +20% of sensing distance at 23°C in the temperature range of 100 to 110°C.		
Voltage influence		±10% max. of sensing distance at rated voltage in the 15% rated voltage range.		
Insulation resistance		50 MΩ min. (at 500 VDC) between current-carrying parts and case		
Dielectric strength		1,000 VAC, 50/60 Hz for 1 min between current-carrying parts and case		
Vibration resistance		Destruction: 10 to 55 Hz 1.5-mm double amplitude for 2 hours each in X, Y and Z directions		
Shock resistance		Destruction: 1,000 m/s <sup>2</sup> , 10 times each in X, Y and Z directions		
Degree of protection		IEC IP67, DIN 40050-9 IP69K *5		
Connection method		Pre-wired Models (Standard cable length 2 m), Connector Models		
Weight (packed state)	Pre-wired Models	Approx. 80 g	Approx. 145 g	Approx. 220 g
	Connector Models	Approx. 30 g	Approx. 55 g	Approx. 125 g
Materials	Case, clamping nut	Stainless steel (SUS316L)		
	Sensing surface	PBT		
	Cable	Heat-resistant PVC cable (Pre-wired model)		
Accessories		Instruction manual		

\*1. Use the yellow indicator on D1 Models as a guide.

\*2. The response frequency is an average value.

Measurement conditions are as follows: standard sensing object, a distance of twice the standard sensing object, and a set distance of half the sensing distance.

\*3. The residual voltage of each E2EH-X□D□ DC 2-Wire Model is 5 V. When connecting to a device, make sure that the device can withstand the residual voltage. (Refer to page 9.)

\*4. Operation with power supplied for 1,000 h has been verified at 110°C. Do not bend the cable repeatedly at 100°C or higher.

\*5. IP69K Degree of Protection Specification

IP69K is a protection standard against high temperature and high-pressure water defined in the German standard DIN 40050, Part 9. The test piece is sprayed with water at 80°C at a water pressure of 80 to 100 BAR using a specified nozzle shape at a rate of 14 to 16 liters/min.

The distance between the test piece and nozzle is 10 to 15 cm, and water is sprayed horizontally for 30 seconds each at 0°, 30°, 60°, and 90° while rotating the test piece on a horizontal plane.

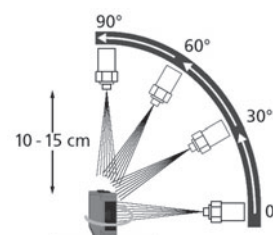

## E2EH-X□C□/B□ DC 3-Wire Models

Item	Size Shielded Model	M12	M18	M30
		Shielded		
		E2EH-X3C□/B□	E2EH-X7C□/B□	E2EH-X12C□/B□
<b>Sensing distance</b>		3 mm±10%	7 mm±10%	12 mm±10%
<b>Set distance *1</b>		0 to 2.4 mm	0 to 5.6 mm	0 to 9.6 mm
<b>Differential travel</b>		15% max. of sensing distance		
<b>Detectable object</b>		Ferrous metal (The sensing distance decreases with non-ferrous metal. Refer to <i>Engineering Data</i> on page 6.)		
<b>Standard sensing object</b>		Iron, 12 × 12 × 1 mm	Iron 21 × 21 × 1 mm	Iron 36 × 36 × 1 mm
<b>Response frequency *2</b>		500 Hz	300 Hz	100 Hz
<b>Power supply voltage (operating voltage range)</b>		12 to 24 VDC, ripple (p-p): 10% max. (10 to 32 VDC, however, 24 VDC max. at temperatures over 100°C)		
<b>Current consumption</b>		10 mA max.		
<b>Control output</b>	<b>Load current</b>	100 mA max. (however, 50 mA max. at 100 to 120°C)		
	<b>Residual voltage</b>	2 V max. (Load current: 100 mA, Cable length 2 m)		
<b>Indicators</b>		Operation indicator (yellow)		
<b>Operating mode (with sensing object approaching)</b>		C1 Models: NO C2 Models: NC B1 Models: NO B2 Models: NC Refer to the timing charts under <i>I/O Circuit Diagrams</i> on page 7 for details.		
<b>Protection circuits</b>		Power supply reverse polarity protection, Surge suppressor, Load short-circuit protection, Reversed output polarity protection		
<b>Ambient temperature range</b>		Operating: 0 to 100°C (0 to 120°C 1,000 h) *2 Storage: -25 to 70°C (with no icing or condensation)		
<b>Ambient humidity range</b>		35% to 95%		
<b>Temperature influence</b>		±10% max. of sensing distance at 23°C in the temperature range of 0 to 70°C. ±15% max. of sensing distance at 23°C in the temperature range of 70 to 100°C. -15% to 20% of sensing distance at 23°C in the temperature range of 100 to 120°C.		
<b>Voltage influence</b>		10% max. of sensing distance at rated voltage in the 15% rated voltage range.		
<b>Insulation resistance</b>		50 MΩ min. (at 500 VDC) between current-carrying parts and case		
<b>Dielectric strength</b>		1,000 VAC, 50/60 Hz for 1 min between current-carrying parts and case		
<b>Vibration resistance</b>		Destruction: 10 to 55 Hz 1.5-mm double amplitude for 2 hours each in X, Y and Z directions		
<b>Shock resistance</b>		Destruction: 1,000 m/s <sup>2</sup> , 10 times each in X, Y and Z directions		
<b>Degree of protection</b>		IEC IP67, DIN 40050-9 IP69K		
<b>Connection method</b>		Pre-wired Models (Standard cable length 2 m), Connector Models		
<b>Weight (packed state)</b>	<b>Pre-wired Models</b>	Approx. 80 g	Approx. 145 g	Approx. 220 g
	<b>Connector Models</b>	Approx. 30 g	Approx. 55 g	Approx. 125 g
<b>Materials</b>	<b>Case, clamping nut</b>	Stainless steel (SUS316L)		
	<b>Sensing surface</b>	PBT		
	<b>Cable</b>	Heat-resistant PVC cable (Pre-wired Model)		
<b>Accessories</b>		Instruction manual		

\*1. The response frequency is an average value.

Measurement conditions are as follows: standard sensing object, a distance of twice the standard sensing object, and a set distance of half the sensing distance.

\*2. Operation with power supplied for 1,000 h has been verified at 120°C. Do not bend the cable repeatedly at 100°C or higher.

### Resistance to Detergents, Disinfectants, and Chemicals

- Performance is assured for typical detergents and disinfectants, but performance may not be maintained for some detergents and disinfectants. Refer to the following table when using these agents.
- The E2EH passed testing for resistance to detergents and disinfectants performed using the items in the following table. Refer to this table when considering use of detergents and disinfectants.

Category	Product name	Concentration	Temperature	Time
Chemical	Sodium hydroxide (NaOH)	1.5%	70°C	240h
	Potassium hydroxide (KOH)	1.5%	70°C	240h
	Phosphoric acid (H <sub>3</sub> PO <sub>4</sub> )	2.5%	70°C	240h
	Sodium hypochlorite (NaClO)	0.3%	25°C	240h
	Hydrogen peroxide (H <sub>2</sub> O <sub>2</sub> )	6.5%	25°C	240h
Alkaline foam detergent	P3-topax-66s (Manufactured by Ecolab)	3.0%	70°C	240h
Acidic foam detergent	P3-topax-56 (Manufactured by Ecolab)	5.0%	70°C	240h
Disinfectant	P3-oxonia active 90 (Manufactured by Ecolab)	1.0%	25°C	240h

### Test Conditions

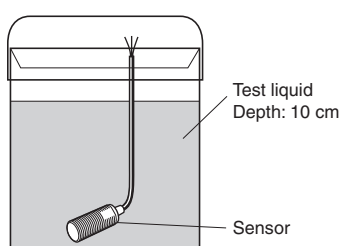

After the test is completed, check that no problems exist with the following product characteristics.

- (1) Appearance (no damage that will affect the product characteristics)
- (2) Operation Check (ON/OFF)
- (3) Insulation resistance: 50 MΩ min. (at 500 VDC)
- (4) Dielectric strength (1,000 VAC for 1 minute)
- (5) Water resistance (IP67)

Engineering Data (Reference Value)

Sensing Area  
Shielded Models  
E2EH-X□□

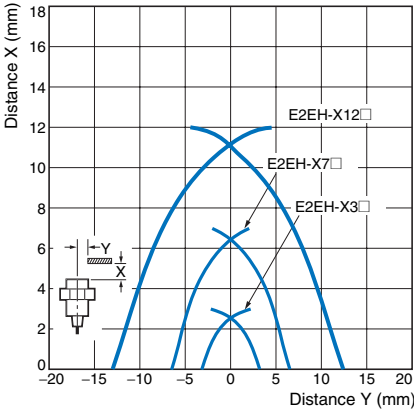

Influence of Sensing Object Size and Material

E2EH-X3□□

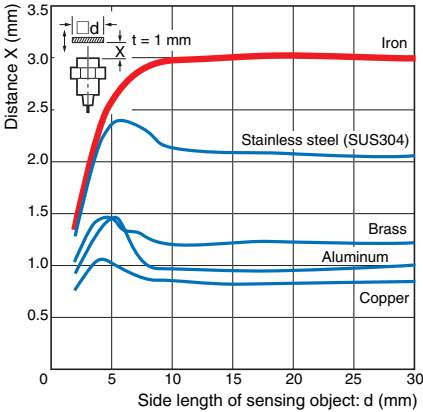

E2EH-X7□□

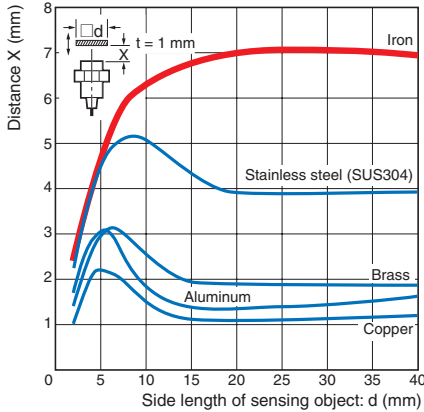

E2EH-X12□□

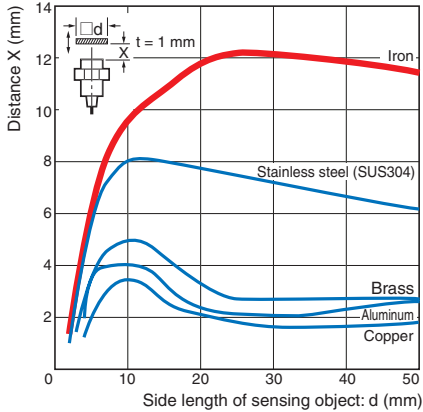

Residual Output Voltage

E2EH-X□D□

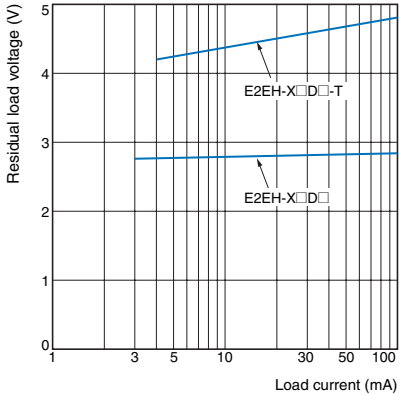

Leakage Current

E2EH-X□D□

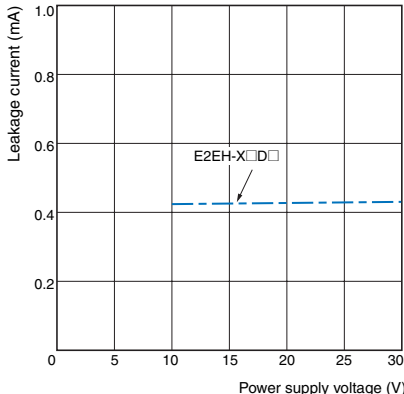

# I/O Circuit Diagrams

## E2EH-X□D□ DC 2-Wire Models

Operating mode	Model	Timing charts	Output circuit
NO	E2EH-X□D1 E2EH-X□D1-M1G	<p>Non-sensing area    Unstable sensing area    Stable sensing area</p> <p>Sensing object</p> <p>Proximity Sensor</p>	<p>Polarity: Yes</p> <p>Note: The load can be connected to either the +V or 0 V side.</p>
	E2EH-X□D1-T	<p>(%)    100    80    0</p> <p>Rated sensing distance</p> <p>ON Setting indicator (yellow) OFF</p> <p>ON Operation indicator (red) OFF</p> <p>ON Control output OFF</p>	<p>Polarity: None</p> <p>Note: 1. The load can be connected to either the +V or 0 V side. 2. The E2EH-X□D1-T has no polarity. Therefore, you do not need to consider the polarity.</p>
NC	E2EH-X□D2 E2EH-X□D2-M1G	<p>Non-sensing area    Sensing area</p> <p>Sensing object</p> <p>Proximity sensor</p>	<p>Note: The load can be connected to either the +V or 0 V side.</p>

## DC 3-Wire Models

Operating mode	Output specifications	Model	Timing charts	Output circuit
NO	NPN Open-collector output	E2EH-X□C1	<p>Sensing object Present Not present</p> <p>Operation indicator (yellow) ON OFF</p> <p>Control output ON OFF</p>	<p>Note: Use pin 1, 4, and 3 for NO. Use pin 1, 2, and 3 for NC.</p>
NC		E2EH-X□C2	<p>Sensing object Present Not present</p> <p>Operation indicator (yellow) ON OFF</p> <p>Control output ON OFF</p>	
NO	PNP Open-collector output	E2EH-X□B1	<p>Sensing object Present Not present</p> <p>Operation indicator (yellow) ON OFF</p> <p>Control output ON OFF</p>	<p>Note: Use pin 1, 4, and 3 for NO. Use pin 1, 2, and 3 for NC.</p>
NC		E2EH-X□B2	<p>Sensing object Present Not present</p> <p>Operation indicator (yellow) ON OFF</p> <p>Control output ON OFF</p>	

Connections for Sensor I/O Connectors

Con- nection diagram No.	Proximity Sensor			Sensor I/O Connector model	Connections
	Type	Operating mode	Model		
1	DC 2-wire (IEC pin wiring)	NO	E2EH-X□D1-M1G	XS2F-E42□-□80-E 1: Straight 2: L-shape D: 2-m cable G: 5-m cable	
2		NC	E2EH-X□D2-M1G		
3	DC 3-wire	NO	E2EH-X□B1-M1 E2EH-X□C1-M1		
4		NC	E2EH-X□B2-M1 E2EH-X□C2-M1		

\*XS2F wire colors differ from Proximity Sensor wire colors.

Refer to the *Sensor I/O Connector Group Catalog* (Cat. No. X073) for details.



## Safety Precautions

Refer to *Warranty and Limitations of Liability* for details.

### ⚠ WARNING

This product is not designed or rated for ensuring safety of persons either directly or indirectly. Do not use it for such purposes.



### Precautions for Correct Use

Do not use this product under ambient conditions that exceed the ratings.

#### ● Design

##### Influence of Surrounding Metal

When mounting the Sensor within a metal panel, ensure that the clearances given in the following table are maintained.

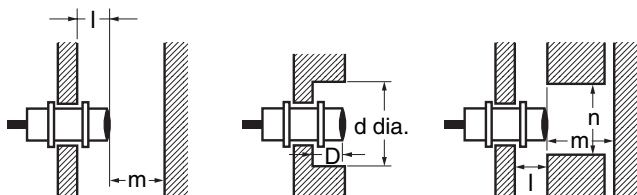

##### Influence of Surrounding Metal

(Unit: mm)

Type	Item	M12	M18	M30	
DC 2-wire E2EM-X□D□	Shielded	l	2.4	3.6	6
		d	18	27	50
		D	2.4	3.6	6
		m	12	24	45
		n	18	27	50
DC 3-wire E2EH-X□B□ E2EH-X□C□	Shielded	l	2.4	3.6	6
		d	18	27	50
		D	2.4	3.6	6
		m	12	24	45
		n	18	27	50

##### AND/OR Connections

Error pulses and leakage current may prevent application in AND or OR circuits. Always confirm operation in advance to confirm if there are any problems in operation.

##### Mutual Interference

When installing Sensors face-to-face or side-by-side, ensure that the minimum distances given in the following table are maintained.

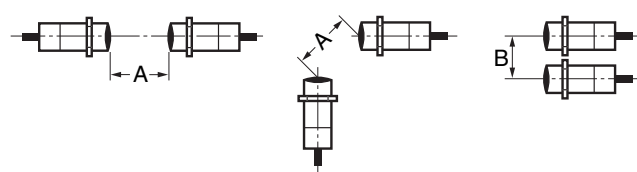

##### Mutual Interference

(Unit: mm)

Type	Item	M12	M18	M30	
DC 2-wire E2EH-X□D□	Shielded	A	30	60	110
		B	20	35	90
DC 3-wire E2EH-X□B□ E2EH-X□C□	Shielded	A	30	60	110
		B	20	35	90

## Connecting a DC 2-wire Proximity Sensor to a PLC (Programmable Controller)

### Required Conditions

Connection to a PLC is possible if the specifications of the PLC and Proximity Sensor satisfy the following conditions. (The meanings of the symbols are given below.)

- The ON voltage of the PLC and the residual voltage of the Proximity Sensor must satisfy the following.

$$V_{ON} \leq V_{CC} - V_R$$

- The OFF current of the PLC and the leakage current of the Proximity Sensor must satisfy the following.

$$I_{OFF} \geq I_{leak}$$

(If the OFF current is not listed in the specifications, take it to be 1.3 mA.)

- The ON current of the PLC and the control output of the Proximity Sensor must satisfy the following.

$$I_{OUT}(\min) \leq I_{ON} \leq I_{OUT}(\max)$$

The ON current will vary, however, with the power supply voltage and the input impedance, as shown in the following equation.

$$I_{ON} = (V_{CC} - V_R - \underline{V_{PC}}) / R_{IN}$$

### Example

In this example, the above conditions are checked when the PLC Unit is the C200H-ID212, the Proximity Sensor is the E2EH-X7D1-T, and the power supply voltage is 24 V.

- $V_{ON} (14.4 \text{ V}) \leq V_{CC} (20.4 \text{ V}) - V_R (5 \text{ V}) = 15.4 \text{ V}$  : OK
- $I_{OFF} (1.3 \text{ mA}) \geq I_{leak} (0.8 \text{ mA})$  : OK
- $I_{ON} = [V_{CC} (20.4 \text{ V}) - V_R (5 \text{ V}) - \underline{V_{PC}} (4 \text{ V})] / R_{IN} (3 \text{ k}\Omega) \cong \text{Approx. } 3.8 \text{ mA}$   
Therefore,  $I_{OUT}(\min) (3 \text{ mA}) \leq I_{ON} (3.8 \text{ mA})$  : OK

$V_{ON}$ :	ON voltage of PLC (14.4 V)
$I_{ON}$ :	ON current of PLC (typ. 7 mA)
$I_{OFF}$ :	OFF current of PLC (1.3 mA)
$R_{IN}$ :	Input impedance of PLC (3 kΩ)
$V_{PC}$ :	Internal residual voltage of PLC (4 V)
$V_R$ :	Output residual voltage of Proximity Sensor (5 V)
$I_{leak}$ :	Leakage current of Proximity Sensor (3 to 100 mA)
$I_{OUT}$ :	Control output of Proximity Sensor (3 to 100 mA)
$V_{CC}$ :	Power supply voltage (PLC: 20.4 to 26.4 V)

Values in parentheses apply to the following PLC model and Proximity Sensor model.

PLC: C200H-ID212  
Sensor: E2EH-X7D1-T

● Mounting

Tightening Force

Do not tighten the nut with excessive force.

Model	Torque
M12	30 N·m
M18	70 N·m
M30	180 N·m

Dimensions

(Unit: mm)  
Tolerance class IT16 applies to dimensions in this data sheet unless otherwise specified.

Pre-wired Models (Shielded)

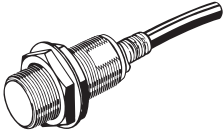

Mounting Hole Dimensions

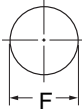

Dimensions	M12	M18	M30
F (mm)	12.5 <sup>+0.5</sup> / <sub>0</sub> dia.	18.5 <sup>+0.5</sup> / <sub>0</sub> dia.	30.5 <sup>+0.5</sup> / <sub>0</sub> dia.

Connector Models (Shielded)

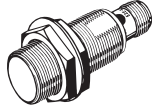

Mounting Hole Dimensions



Dimensions	M12	M18	M30
F (mm)	12.5 <sup>+0.5</sup> / <sub>0</sub> dia.	18.5 <sup>+0.5</sup> / <sub>0</sub> dia.	30.5 <sup>+0.5</sup> / <sub>0</sub> dia.

E2EH-X3□□

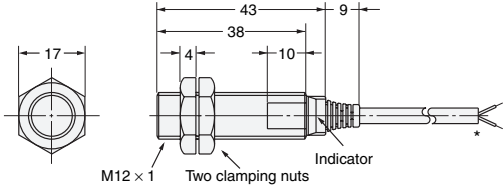

\*4-dia. 2-conductor heat-resistant PVC cable (Conductor cross section: 0.3 mm<sup>2</sup>, insulator diameter: 1.3 mm), Standard length: 2 m.  
4-dia. 3-conductor heat-resistant PVC cable (Conductor cross section: 0.3 mm<sup>2</sup>, insulator diameter: 1.3 mm), Standard length: 2 m.

E2EH-X3□□-M1□

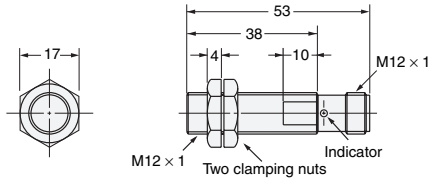

E2EH-X7□□

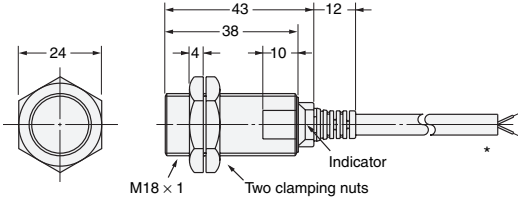

\*6-dia. 2-conductor heat-resistant PVC cable (Conductor cross section: 0.5 mm<sup>2</sup>, insulator diameter: 1.9 mm), Standard length: 2 m.  
6-dia. 3-conductor heat-resistant PVC cable (Conductor cross section: 0.5 mm<sup>2</sup>, insulator diameter: 1.9 mm), Standard length: 2 m.

E2EH-X7□□-M1□

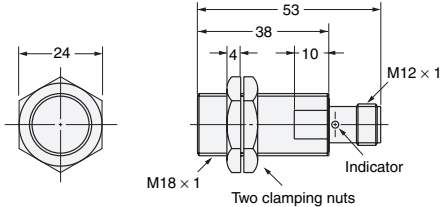

E2EH-X12□□

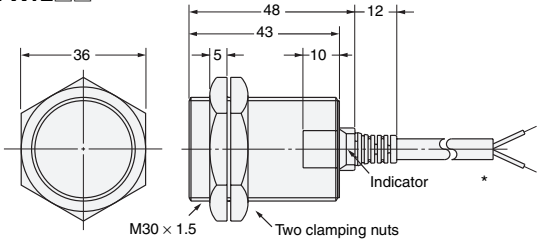

\*6-dia. 2-conductor heat-resistant PVC cable (Conductor cross section: 0.5 mm<sup>2</sup>, insulator diameter: 1.9 mm), Standard length: 2 m.  
6-dia. 3-conductor heat-resistant PVC cable (Conductor cross section: 0.5 mm<sup>2</sup>, insulator diameter: 1.9 mm), Standard length: 2 m.

E2EH-X12□□-M1□

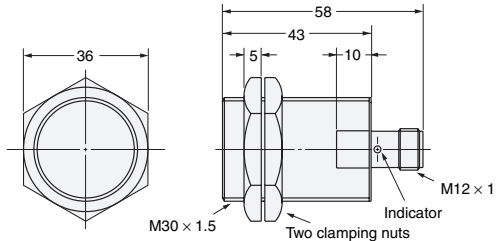

## Read and Understand This Catalog

Please read and understand this catalog before purchasing the products. Please consult your OMRON representative if you have any questions or comments.

## Warranty and Limitations of Liability

### WARRANTY

OMRON's exclusive warranty is that the products are free from defects in materials and workmanship for a period of one year (or other period if specified) from date of sale by OMRON.

OMRON MAKES NO WARRANTY OR REPRESENTATION, EXPRESS OR IMPLIED, REGARDING NON-INFRINGEMENT, MERCHANTABILITY, OR FITNESS FOR PARTICULAR PURPOSE OF THE PRODUCTS. ANY BUYER OR USER ACKNOWLEDGES THAT THE BUYER OR USER ALONE HAS DETERMINED THAT THE PRODUCTS WILL SUITABLY MEET THE REQUIREMENTS OF THEIR INTENDED USE. OMRON DISCLAIMS ALL OTHER WARRANTIES, EXPRESS OR IMPLIED.

### LIMITATIONS OF LIABILITY

OMRON SHALL NOT BE RESPONSIBLE FOR SPECIAL, INDIRECT, OR CONSEQUENTIAL DAMAGES, LOSS OF PROFITS OR COMMERCIAL LOSS IN ANY WAY CONNECTED WITH THE PRODUCTS, WHETHER SUCH CLAIM IS BASED ON CONTRACT, WARRANTY, NEGLIGENCE, OR STRICT LIABILITY.

In no event shall the responsibility of OMRON for any act exceed the individual price of the product on which liability is asserted.

IN NO EVENT SHALL OMRON BE RESPONSIBLE FOR WARRANTY, REPAIR, OR OTHER CLAIMS REGARDING THE PRODUCTS UNLESS OMRON'S ANALYSIS CONFIRMS THAT THE PRODUCTS WERE PROPERLY HANDLED, STORED, INSTALLED, AND MAINTAINED AND NOT SUBJECT TO CONTAMINATION, ABUSE, MISUSE, OR INAPPROPRIATE MODIFICATION OR REPAIR.

## Application Considerations

### SUITABILITY FOR USE

OMRON shall not be responsible for conformity with any standards, codes, or regulations that apply to the combination of products in the customer's application or use of the products.

At the customer's request, OMRON will provide applicable third party certification documents identifying ratings and limitations of use that apply to the products. This information by itself is not sufficient for a complete determination of the suitability of the products in combination with the end product, machine, system, or other application or use.

The following are some examples of applications for which particular attention must be given. This is not intended to be an exhaustive list of all possible uses of the products, nor is it intended to imply that the uses listed may be suitable for the products:

- Outdoor use, uses involving potential chemical contamination or electrical interference, or conditions or uses not described in this catalog.
- Nuclear energy control systems, combustion systems, railroad systems, aviation systems, medical equipment, amusement machines, vehicles, safety equipment, and installations subject to separate industry or government regulations.
- Systems, machines, and equipment that could present a risk to life or property.

Please know and observe all prohibitions of use applicable to the products.

NEVER USE THE PRODUCTS FOR AN APPLICATION INVOLVING SERIOUS RISK TO LIFE OR PROPERTY WITHOUT ENSURING THAT THE SYSTEM AS A WHOLE HAS BEEN DESIGNED TO ADDRESS THE RISKS, AND THAT THE OMRON PRODUCTS ARE PROPERLY RATED AND INSTALLED FOR THE INTENDED USE WITHIN THE OVERALL EQUIPMENT OR SYSTEM.

### PROGRAMMABLE PRODUCTS

OMRON shall not be responsible for the user's programming of a programmable product, or any consequence thereof.

## Disclaimers

### CHANGE IN SPECIFICATIONS

Product specifications and accessories may be changed at any time based on improvements and other reasons.

It is our practice to change model numbers when published ratings or features are changed, or when significant construction changes are made. However, some specifications of the products may be changed without any notice. When in doubt, special model numbers may be assigned to fix or establish key specifications for your application on your request. Please consult with your OMRON representative at any time to confirm actual specifications of purchased products.

### DIMENSIONS AND WEIGHTS

Dimensions and weights are nominal and are not to be used for manufacturing purposes, even when tolerances are shown.

### PERFORMANCE DATA

Performance data given in this catalog is provided as a guide for the user in determining suitability and does not constitute a warranty. It may represent the result of OMRON's test conditions, and the users must correlate it to actual application requirements. Actual performance is subject to the OMRON Warranty and Limitations of Liability.

### ERRORS AND OMISSIONS

The information in this document has been carefully checked and is believed to be accurate; however, no responsibility is assumed for clerical, typographical, or proofreading errors, or omissions.

2012.8

In the interest of product improvement, specifications are subject to change without notice.

**OMRON Corporation**  
Industrial Automation Company

<http://www.ia.omron.com/>

(c)Copyright OMRON Corporation 2012 All Right Reserved.



Компания «ЭлектроПласт» предлагает заключение долгосрочных отношений при поставках импортных электронных компонентов на взаимовыгодных условиях!

Наши преимущества:

- Оперативные поставки широкого спектра электронных компонентов отечественного и импортного производства напрямую от производителей и с крупнейших мировых складов;
- Поставка более 17-ти миллионов наименований электронных компонентов;
- Поставка сложных, дефицитных, либо снятых с производства позиций;
- Оперативные сроки поставки под заказ (от 5 рабочих дней);
- Экспресс доставка в любую точку России;
- Техническая поддержка проекта, помощь в подборе аналогов, поставка прототипов;
- Система менеджмента качества сертифицирована по Международному стандарту ISO 9001;
- Лицензия ФСБ на осуществление работ с использованием сведений, составляющих государственную тайну;
- Поставка специализированных компонентов (Xilinx, Altera, Analog Devices, Intersil, Interpoint, Microsemi, Aeroflex, Peregrine, Syfer, Eurofarad, Texas Instrument, Miteq, Cobham, E2V, MA-COM, Hittite, Mini-Circuits, General Dynamics и др.);

Помимо этого, одним из направлений компании «ЭлектроПласт» является направление «Источники питания». Мы предлагаем Вам помощь Конструкторского отдела:

- Подбор оптимального решения, техническое обоснование при выборе компонента;
- Подбор аналогов;
- Консультации по применению компонента;
- Поставка образцов и прототипов;
- Техническая поддержка проекта;
- Защита от снятия компонента с производства.



#### Как с нами связаться

**Телефон:** 8 (812) 309 58 32 (многоканальный)

**Факс:** 8 (812) 320-02-42

**Электронная почта:** [org@eplast1.ru](mailto:org@eplast1.ru)

**Адрес:** 198099, г. Санкт-Петербург, ул. Калинина, дом 2, корпус 4, литера А.