

Altech Corp.®

Serving the Automation & Control Industry since 1984

Certified System



ISO 9001
QMI-SAI Global



TOWER LIGHTS

TOWER LIGHTS

**Choose
Different
Colors
& Set Your
Own Combination**



Altech Corp.[®]
TOWERLights

- Sleek, stackable design
- SMD LED technology
- Uniform, bright illumination
- Integrated LED Light Modules available in continuous, flashing and rotary versions
- Flexibility to upgrade from Single LED unit to multiple LED units
- IP65 protection
- Wide voltage range from 12V AC/DC to 240V AC
- Optional Buzzer feature with dual sound mode - continuous & intermittent with 80 DB output

INTERNATIONAL APPROVALS



The UL standards extend to:
NEMA Type: 1 | 2 | 3 | 3R | 4 | 4X | 12 | 13
Indoor or outdoor use primarily to provide a degree of protection against corrosion, windblown dust and rain, splashing water, hose-directed water, and damage from external ice formation.

TECHNICAL INFORMATION

Outer Diameter	Ø50mm
Degree of Protection	IP65, NEMA Type 4X and 13, UL 508
LED Type	SMD
Unit Color	Red / Green / Amber / Blue / White
Unit Signalling Effect	Continuous, Blinking & Revolving
Buzzer Color	Black
Buzzer Mode	80dB ± 5dB
Sounding Mode	Continuous & Intermittent
Available Voltages	12V AC/DC; 24V AC/DC 120V AC; 240V AC
Voltage Tolerance	±10% of rated voltage
Operating Temperature	-30°C to 60°C
Surge Test	2 KV
HV Test for 60 Seconds	1.5 KV
Current Rating	20-40mA for 12V AC/DC; 24V AC/DC 10-20mA for 120V AC & 240V AC

DIMENSIONS

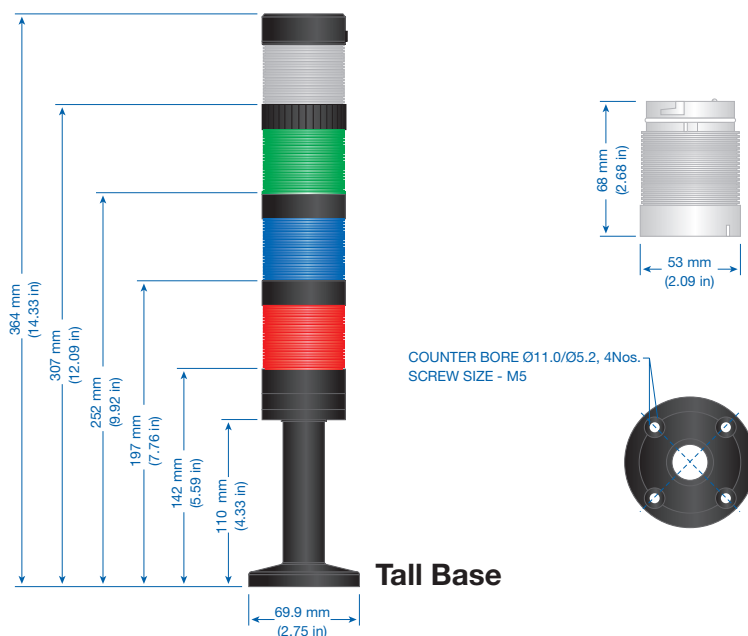
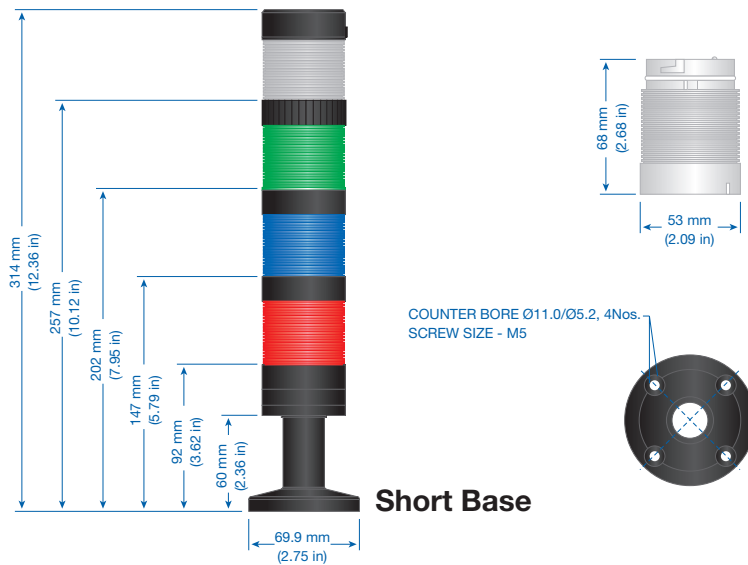

BASES AND CAP



Part No.	Description	Std. Pack
TL5001	Short Base, Plastic	1
TL5002	Tall Base, Plastic	1

Accessories		
Part No.	Description	Std. Pack
TL12004	Upper Cap for Tower Light, Plastic	1
TL122002	Terminal Holder, Plastic	1
TL122003	Terminal Holder Cover, Plastic	1

NOTE: All bases come with Cap, Terminal Holder and Terminal Holder Cover.

SOUND MODULE



Part No.	Description	Voltage	Mode	Approvals	Std. Pack
TL50Z1U	50mm Sound Module, Buzzer	24V AC/DC	Continuous, 80dB	UL cUL R NEMA	1
TL50Z2U	50mm Sound Module, Buzzer	24V AC/DC	Intermittent, 80dB	UL cUL NEMA	1
TL50Z1W	50mm Sound Module, Buzzer	120V AC	Continuous, 80dB	UL cUL NEMA	1
TL50Z2W	50mm Sound Module, Buzzer	120V AC	Intermittent, 80dB	UL cUL NEMA	1
TL50Z1X	50mm Sound Module, Buzzer	240V AC	Continuous, 80dB	UL cUL NEMA	1
TL50Z2X	50mm Sound Module, Buzzer	240V AC	Intermittent, 80dB	UL cUL NEMA	1
TL50Z1T	50mm Sound Module, Buzzer	12V AC/DC	Continuous, 80dB		1
TL50Z2T	50mm Sound Module, Buzzer	12V AC/DC	Intermittent, 80dB		1

*Cap included with sound module and not removable.

Online Part Builder

To build your tower light go to www.altechcorp.com/towerlights.

Download our interactive EXCEL file to easily build the appropriate tower light part number for your documentation **A** reference and receive a list of components to order and build your specific tower light. **B**

LENS MODULES



	Part No.	Description	Color	Mode	Approvals	Std. Pack
12 VOLTS	TL50LA1T	12V AC/DC, 50mm Lens Module	Amber	Continuous LED	☐ ☐ NEMA	1
	TL50LB1T	12V AC/DC, 50mm Lens Module	Blue	Continuous LED	☐ ☐ NEMA	1
	TL50LG1T	12V AC/DC, 50mm Lens Module	Green	Continuous LED	☐ ☐ NEMA	1
	TL50LR1T	12V AC/DC, 50mm Lens Module	Red	Continuous LED	☐ ☐ NEMA	1
	TL50LW1T	12V AC/DC, 50mm Lens Module	White	Continuous LED	☐ ☐ NEMA	1
	TL50LA2T	12V AC/DC, 50mm Lens Module	Amber	Flashing LED	☐ ☐ NEMA	1
	TL50LB2T	12V AC/DC, 50mm Lens Module	Blue	Flashing LED	☐ ☐ NEMA	1
	TL50LG2T	12V AC/DC, 50mm Lens Module	Green	Flashing LED	☐ ☐ NEMA	1
	TL50LR2T	12V AC/DC, 50mm Lens Module	Red	Flashing LED	☐ ☐ NEMA	1
	TL50LW2T	12V AC/DC, 50mm Lens Module	White	Flashing LED	☐ ☐ NEMA	1
	TL50LA3T	12V AC/DC, 50mm Lens Module	Amber	Rotating LED	☐ ☐ NEMA	1
	TL50LB3T	12V AC/DC, 50mm Lens Module	Blue	Rotating LED	☐ ☐ NEMA	1
	TL50LG3T	12V AC/DC, 50mm Lens Module	Green	Rotating LED	☐ ☐ NEMA	1
24 VOLTS	TL50LR3T	12V AC/DC, 50mm Lens Module	Red	Rotating LED	☐ ☐ NEMA	1
	TL50LW3T	12V AC/DC, 50mm Lens Module	White	Rotating LED	☐ ☐ NEMA	1
	TL50LA1U	24V AC/DC, 50mm Lens Module	Amber	Continuous LED	☐ ☐ ☐ NEMA	1
	TL50LB1U	24V AC/DC, 50mm Lens Module	Blue	Continuous LED	☐ ☐ ☐ NEMA	1
	TL50LG1U	24V AC/DC, 50mm Lens Module	Green	Continuous LED	☐ ☐ ☐ NEMA	1
	TL50LR1U	24V AC/DC, 50mm Lens Module	Red	Continuous LED	☐ ☐ ☐ NEMA	1
	TL50LW1U	24V AC/DC, 50mm Lens Module	White	Continuous LED	☐ ☐ ☐ NEMA	1
	TL50LA2U	24V AC/DC, 50mm Lens Module	Amber	Flashing LED	☐ ☐ ☐ NEMA	1
	TL50LB2U	24V AC/DC, 50mm Lens Module	Blue	Flashing LED	☐ ☐ ☐ NEMA	1
	TL50LG2U	24V AC/DC, 50mm Lens Module	Green	Flashing LED	☐ ☐ ☐ NEMA	1
	TL50LR2U	24V AC/DC, 50mm Lens Module	Red	Flashing LED	☐ ☐ ☐ NEMA	1
	TL50LW2U	24V AC/DC, 50mm Lens Module	White	Flashing LED	☐ ☐ ☐ NEMA	1
	TL50LA3U	24V AC/DC, 50mm Lens Module	Amber	Rotating LED	☐ ☐ ☐ NEMA	1
120 VOLTS	TL50LB3U	24V AC/DC, 50mm Lens Module	Blue	Rotating LED	☐ ☐ ☐ NEMA	1
	TL50LG3U	24V AC/DC, 50mm Lens Module	Green	Rotating LED	☐ ☐ ☐ NEMA	1
	TL50LR3U	24V AC/DC, 50mm Lens Module	Red	Rotating LED	☐ ☐ ☐ NEMA	1
	TL50LW3U	24V AC/DC, 50mm Lens Module	White	Rotating LED	☐ ☐ ☐ NEMA	1
	TL50LA1W	120V AC, 50mm Lens Module	Amber	Continuous LED	☐ ☐ ☐ NEMA	1
	TL50LB1W	120V AC, 50mm Lens Module	Blue	Continuous LED	☐ ☐ ☐ NEMA	1
	TL50LG1W	120V AC, 50mm Lens Module	Green	Continuous LED	☐ ☐ ☐ NEMA	1
	TL50LR1W	120V AC, 50mm Lens Module	Red	Continuous LED	☐ ☐ ☐ NEMA	1
	TL50LW1W	120V AC, 50mm Lens Module	White	Continuous LED	☐ ☐ ☐ NEMA	1
	TL50LA2W	120V AC, 50mm Lens Module	Amber	Flashing LED	☐ ☐ ☐ NEMA	1
	TL50LB2W	120V AC, 50mm Lens Module	Blue	Flashing LED	☐ ☐ ☐ NEMA	1
	TL50LG2W	120V AC, 50mm Lens Module	Green	Flashing LED	☐ ☐ ☐ NEMA	1
	TL50LR2W	120V AC, 50mm Lens Module	Red	Flashing LED	☐ ☐ ☐ NEMA	1
240 VOLTS	TL50LW2W	120V AC, 50mm Lens Module	White	Flashing LED	☐ ☐ ☐ NEMA	1
	TL50LA3W	120V AC, 50mm Lens Module	Amber	Rotating LED	☐ ☐ ☐ NEMA	1
	TL50LB3W	120V AC, 50mm Lens Module	Blue	Rotating LED	☐ ☐ ☐ NEMA	1
	TL50LG3W	120V AC, 50mm Lens Module	Green	Rotating LED	☐ ☐ ☐ NEMA	1
	TL50LR3W	120V AC, 50mm Lens Module	Red	Rotating LED	☐ ☐ ☐ NEMA	1
	TL50LW3W	120V AC, 50mm Lens Module	White	Rotating LED	☐ ☐ ☐ NEMA	1
	TL50LA1X	240V AC, 50mm Lens Module	Amber	Continuous LED	☐ ☐ ☐ NEMA	1
	TL50LB1X	240V AC, 50mm Lens Module	Blue	Continuous LED	☐ ☐ ☐ NEMA	1
	TL50LG1X	240V AC, 50mm Lens Module	Green	Continuous LED	☐ ☐ ☐ NEMA	1
	TL50LR1X	240V AC, 50mm Lens Module	Red	Continuous LED	☐ ☐ ☐ NEMA	1
	TL50LW1X	240V AC, 50mm Lens Module	White	Continuous LED	☐ ☐ ☐ NEMA	1
	TL50LA2X	240V AC, 50mm Lens Module	Amber	Flashing LED	☐ ☐ ☐ NEMA	1
	TL50LB2X	240V AC, 50mm Lens Module	Blue	Flashing LED	☐ ☐ ☐ NEMA	1
TL50LG2X	240V AC, 50mm Lens Module	Green	Flashing LED	☐ ☐ ☐ NEMA	1	
TL50LR2X	240V AC, 50mm Lens Module	Red	Flashing LED	☐ ☐ ☐ NEMA	1	
TL50LW2X	240V AC, 50mm Lens Module	White	Flashing LED	☐ ☐ ☐ NEMA	1	
TL50LA3X	240V AC, 50mm Lens Module	Amber	Rotating LED	☐ ☐ ☐ NEMA	1	
TL50LB3X	240V AC, 50mm Lens Module	Blue	Rotating LED	☐ ☐ ☐ NEMA	1	
TL50LG3X	240V AC, 50mm Lens Module	Green	Rotating LED	☐ ☐ ☐ NEMA	1	
TL50LR3X	240V AC, 50mm Lens Module	Red	Rotating LED	☐ ☐ ☐ NEMA	1	
TL50LW3X	240V AC, 50mm Lens Module	White	Rotating LED	☐ ☐ ☐ NEMA	1	

TOWER LIGHTS

Ordering Information (Components sold individually)

	DESCRIPTION	CODE
Tower Light		TW
Base	Small Base (SB)	1
	Big Base (BB)	2
Voltage	240V AC	X
	120V AC	W
	24V AC/DC	U
	12V AC/DC	T
Unit Color	Red	R
	Green	G
	Amber	A
	Blue	B
	White	W
Luminous Mode	Continuous	1
	Blinking	2
	Revolving	3
Sound Module	Continuous	Z1
	Intermittent	Z2

TW 1 U R 1 G 1 A 2 B 1



Example:
Cat. No. TW1UR1G1A2B1
 Description
 Tower Light with Small Base
 24V AC/DC with Red, Green and Blue
 Continuous Amber Blinking

Buzzer has to be used as last unit in the stack.
 Maximum number of stacks is four.

Standard Available Combinations

Tower Light Without Buzzer

Type	Description	Part No.
Single Stack	Tower light with small base 120V AC with red continuous illumination	TW1WR1
Single Stack	Tower light with small base 120V AC with red blinking illumination	TW1WR2
Two Stack	Tower light with small base 120V AC with red continuous & green continuous illumination	TW1WR1G1
Two Stack	Tower light with small base 24V AC/DC with red continuous & green continuous illumination	TW1UR2G2
Three Stack	Tower light with small base 120V AC with red continuous, green continuous & blue continuous illumination	TW1WR1G1B1
Three Stack	Tower light with small base 240V AC with green continuous, blue continuous and red blinking illumination	TW1XG1B1R2
Four Stack	Tower light with small base 120V AC with red continuous, green continuous, blue continuous & amber continuous illumination	TW1WR1G1B1A1

Tower Light With Buzzer

Type	Description	Part No.
Single Stack	Tower light with small base 120V AC with buzzer continuous	TW1WZ1
Two Stack	Tower light with small base 120V AC with red continuous illumination & buzzer continuous	TW1WR1Z1
Two Stack	Tower light with small base 24V AC/DC with red blinking illumination & buzzer continuous	TW1UR2Z1
Three Stack	Tower light with small base 120V AC/DC with red continuous, green continuous illumination & buzzer continuous	TW1WR1G1Z1
Three Stack	Tower light with small base 24V AC/DC with red blinking, green continuous illumination & buzzer continuous	TW1UR2G1Z1
Four Stack	Tower light with small base 120V AC with red continuous, green continuous, blue continuous & buzzer continuous	TW1WR1G1B1Z1
Four Stack	Tower light with small base 24V AC/DC with green continuous, blue continuous, red blinking illumination & buzzer continuous	TW1UG1B1R2Z1

Note: Mentioned products are available as ex-stock, for any special requirement please refer ordering information or contact Altech Corp.®.

TOWER LIGHTS

Technical Information

Dimensions



SOUND MODULE UNIT BLACK (Cap is not removable)

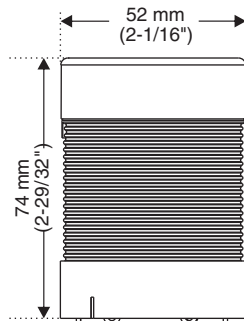

Assembly Mounting



Electrical Wiring

STEP 1



STEP 2

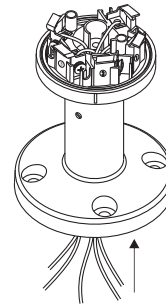

0	common or negative (AC / DC)
1	module position 1
2	module position 2
3	module position 3
4	module position 4

D. Insert the wires into the required terminations for the tower light and tighten to 0.5Nm (5lb* in).

Wiring Diagram

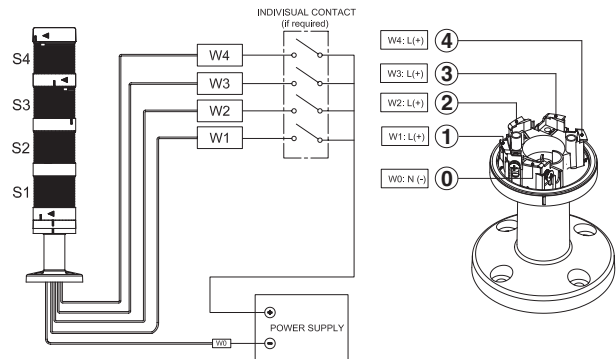

For proper installation and operation of the Tower Light please follow the instructions on both sides of product sheet included with each tower light.



View Our Product Preview Movie

Circuit Protection



Circuit Protection Devices



Busbar and Power Distribution



Contactors, Overload Relays, Manual Motor Starters



Motor Disconnect Switches



European Fuses

Connectors



Industrial Rectangular Connectors



Pin & Sleeve Devices



Receptacles

Foot Switches



Foot Switches

Sensors



Inductive Proximity Sensors

Enclosures



Industrial Enclosures



DIN Enclosures

Modules & Relays

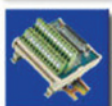

Interface Modules



Safety Relays



Slimline Relays

Power Supplies



Power Supplies

Push Buttons



22 & 30 mm Push Buttons

DIN Rail



DIN Rail

Wire & Cable Management



Liquid Tight Strain Reliefs/Corrugated Tubes

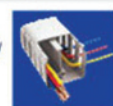

Wire Duct

Terminal Blocks



Din Rail Terminal Blocks



Panel Mount Terminal Blocks



Printed Circuit Board Terminal Blocks



Eurostrips



Distribution Blocks

Miscellaneous



Ferrules



Custom Assembly



Marking & Engraving Systems



Power Semi-conductors

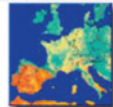

European Spare Parts

WEB TOOLS

Product Crossings

Request for Quote

Sample Request

Catalog Request

PRODUCT MENU

Circuit Protection / Control >

Connectors >

Enclosures >

European Spare Parts >

Foot Switches

Interface Modules >

Power Supplies

Push Buttons & Pilot Lights >

Relays >

Sensors >

Terminal Blocks >

Wire & Cable Management >

Home

Altech Corporation
35 Royal Road
Flemington, NJ 08822-6000
Phone (908) 806-9400
Fax (908) 806-9490
www.altechcorp.com

Altech Corp.® 800-012012-3M



Компания «ЭлектроПласт» предлагает заключение долгосрочных отношений при поставках импортных электронных компонентов на взаимовыгодных условиях!

Наши преимущества:

- Оперативные поставки широкого спектра электронных компонентов отечественного и импортного производства напрямую от производителей и с крупнейших мировых складов;
- Поставка более 17-ти миллионов наименований электронных компонентов;
- Поставка сложных, дефицитных, либо снятых с производства позиций;
- Оперативные сроки поставки под заказ (от 5 рабочих дней);
- Экспресс доставка в любую точку России;
- Техническая поддержка проекта, помощь в подборе аналогов, поставка прототипов;
- Система менеджмента качества сертифицирована по Международному стандарту ISO 9001;
- Лицензия ФСБ на осуществление работ с использованием сведений, составляющих государственную тайну;
- Поставка специализированных компонентов (Xilinx, Altera, Analog Devices, Intersil, Interpoint, Microsemi, Aeroflex, Peregrine, Syfer, Eurofarad, Texas Instrument, Miteq, Cobham, E2V, MA-COM, Hittite, Mini-Circuits, General Dynamics и др.);

Помимо этого, одним из направлений компании «ЭлектроПласт» является направление «Источники питания». Мы предлагаем Вам помощь Конструкторского отдела:

- Подбор оптимального решения, техническое обоснование при выборе компонента;
- Подбор аналогов;
- Консультации по применению компонента;
- Поставка образцов и прототипов;
- Техническая поддержка проекта;
- Защита от снятия компонента с производства.



Как с нами связаться

Телефон: 8 (812) 309 58 32 (многоканальный)

Факс: 8 (812) 320-02-42

Электронная почта: org@eplast1.ru

Адрес: 198099, г. Санкт-Петербург, ул. Калинина, дом 2, корпус 4, литера А.