

Surface Mount PAR[®] Transient Voltage Suppressors

High Temperature Stability and High Reliability Conditions

eSMP[®] Series



TO-277A (SMPC)

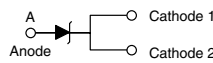

AUTOMOTIVE
GRADE
Available



RoHS
COMPLIANT
HALOGEN
FREE

FEATURES

- Junction passivation optimized design passivated anisotropic rectifier technology
- $T_J = 185\text{ }^\circ\text{C}$ capability suitable for high reliability and automotive requirement
- Very low profile - typical height of 1.1 mm
- Ideal for automated placement
- Uni-direction only
- Excellent clamping capability
- Low incremental surge resistance
- Very fast response time
- Meets MSL level 1, per J-STD-020
- AEC-Q101 qualified
- Material categorization: For definitions of compliance please see www.vishay.com/doc?99912

MECHANICAL DATA

Case: TO-277A (SMPC)

Molding compound meets UL 94 V-0 flammability rating Base P/NHM3 - halogen-free, RoHS-compliant, and automotive grade

Terminals: Matte tin plated leads, solderable per J-STD-002 and JESD 22-B102

HM3 suffix meets JESD 201 class 2 whisker test

PRIMARY CHARACTERISTICS	
V_{WM}	5.50 V to 43.6 V
V_{BR}	6.8 V to 51 V
P_{PPM}	1500 W
T_J max.	185 °C
Polarity	Uni-directional
Package	TO-277A (SMPC)

TYPICAL APPLICATIONS

Use in sensitive electronics protection against voltage transients induced by inductive load switching and lighting on ICs, MOSFET, signal lines of sensor units for consumer, computer, industrial, automotive, and telecommunication.

MAXIMUM RATINGS ($T_A = 25\text{ }^\circ\text{C}$, unless otherwise noted)			
PARAMETER	SYMBOL	VALUE	UNIT
Peak power dissipation with a 10/1000 μs waveform (fig. 3) ⁽¹⁾⁽²⁾	P_{PPM}	1500	W
Peak power pulse current with a 10/1000 μs waveform (fig. 1) ⁽¹⁾	I_{PPM}	See next table	A
Peak forward surge current 8.3 ms single half sine-wave ⁽²⁾	I_{FSM}	200	A
Maximum instantaneous forward voltage at 100 A ⁽³⁾	V_F	3.5	V
Operating junction and storage temperature range	T_J, T_{STG}	- 65 to + 185	°C

Notes

⁽¹⁾ Non-repetitive current pulse, per fig. 3 and derated above $T_A = 25\text{ }^\circ\text{C}$ per fig. 2

⁽²⁾ Measured on 8.3 ms single half sine-wave, or equivalent square wave, duty cycle = 4 pulses per minute maximum

⁽³⁾ Pulse test: 300 μs pulse width, 1 % duty cycle



ELECTRICAL CHARACTERISTICS (T _A = 25 °C, unless otherwise noted)									
DEVICE TYPE	DEVICE MARKING CODE	BREAKDOWN VOLTAGE V _{BR} ⁽¹⁾ AT I _T (V)		TEST CURRENT I _T (mA)	STAND-OFF VOLTAGE V _{WM} (V)	MAXIMUM REVERSE LEAKAGE AT V _{WM} I _R (µA)	MAXIMUM REVERSE LEAKAGE AT V _{WM} T _J = 150 °C I _D (µA)	MAXIMUM PEAK PULSE SURGE CURRENT I _{PPM} ⁽²⁾ (A)	MAXIMUM CLAMPING VOLTAGE AT I _{PPM} V _C (V)
		MIN.	MAX.						
TPC6.8	DDP	6.12	7.48	10	5.50	1500	10 000	139	10.8
TPC6.8A	DEP	6.45	7.14	10	5.80	1500	10 000	143	10.5
TPC7.5	DFP	6.75	8.25	10	6.05	500	5000	128	11.7
TPC7.5A	DGP	7.13	7.88	10	6.40	500	5000	133	11.3
TPC8.2	DHP	7.38	9.02	10	6.63	200	2000	120	12.5
TPC8.2A	DKP	7.79	8.61	10	7.02	200	2000	124	12.1
TPC9.1	DLP	8.19	10.0	1.0	7.37	50	500	109	13.8
TPC9.1A	DMP	8.65	9.55	1.0	7.78	50	500	112	13.4
TPC10	DNP	9.0	11.0	1.0	8.10	20	200	100	15.0
TPC10A	DPP	9.5	10.5	1.0	8.55	20	200	103	14.5
TPC11	DQP	9.9	12.1	1.0	8.92	5.0	50	92.6	16.2
TPC11A	DRP	10.5	11.6	1.0	9.40	5.0	50	96.2	15.6
TPC12	DSP	10.8	13.2	1.0	9.72	2.0	10	86.7	17.3
TPC12A	DTP	11.4	12.6	1.0	10.2	2.0	10	89.8	16.7
TPC13	DUP	11.7	14.3	1.0	10.5	2.0	10	78.9	19.0
TPC13A	DVP	12.4	13.7	1.0	11.1	2.0	10	82.4	18.2
TPC15	DWP	13.5	16.5	1.0	12.1	1.0	10	68.2	22.0
TPC15A	DXP	14.3	15.8	1.0	12.8	1.0	10	70.8	21.2
TPC16	DYP	14.4	17.6	1.0	12.9	1.0	10	63.8	23.5
TPC16A	DZP	15.2	16.8	1.0	13.6	1.0	10	66.7	22.5
TPC18	EDP	16.2	19.8	1.0	14.5	1.0	10	56.6	26.5
TPC18A	EEP	17.1	18.9	1.0	15.3	1.0	10	59.5	25.2
TPC20	EFP	18.0	22.0	1.0	16.2	1.0	10	51.5	29.1
TPC20A	EGP	19.0	21.0	1.0	17.1	1.0	10	54.2	27.7
TPC22	EHP	19.8	24.2	1.0	17.8	1.0	10	47.0	31.9
TPC22A	EKP	20.9	23.1	1.0	18.8	1.0	10	49.0	30.6
TPC24	ELP	21.6	26.4	1.0	19.4	1.0	10	43.2	34.7
TPC24A	EMP	22.8	25.2	1.0	20.5	1.0	10	45.2	33.2
TPC27	ENP	24.3	29.7	1.0	21.8	1.0	10	38.4	39.1
TPC27A	EPP	25.7	28.4	1.0	23.1	1.0	10	40.0	37.5
TPC30	EQP	27.0	33.0	1.0	24.3	1.0	10	34.5	43.5
TPC30A	ERP	28.5	31.5	1.0	25.6	1.0	10	36.2	41.4
TPC33	ESP	29.7	36.3	1.0	26.8	1.0	10	31.4	47.7
TPC33A	ETP	31.4	34.7	1.0	28.2	1.0	10	32.8	45.7
TPC36	EUP	32.4	39.6	1.0	29.1	1.0	15	28.8	52.0
TPC36A	EVP	34.2	37.8	1.0	30.8	1.0	15	30.1	49.9
TPC39	EWP	35.1	42.9	1.0	31.6	1.0	15	26.6	56.4
TPC39A	EXP	37.1	41.0	1.0	33.3	1.0	15	27.8	53.9
TPC43	EYP	38.7	47.3	1.0	34.8	1.0	20	24.2	61.9
TPC43A	EZP	40.9	45.2	1.0	36.8	1.0	20	25.3	59.3
TPC47A	FEP	44.7	49.4	1.0	40.2	1.0	20	23.1	64.8
TPC51A	FGP	48.5	53.6	1.0	43.6	1.0	20	21.4	70.1

Notes

- (1) V_{BR} measured after I_T applied for 300 µs, I_T = square wave pulse or equivalent
- (2) Surge current waveform per fig. 3 and derated per fig. 2
- (3) All terms and symbols are consistent with ANSI/IEEE C62.35



ORDERING INFORMATION (Example)				
PREFERRED P/N	UNIT WEIGHT (g)	PREFERRED PACKAGE CODE	BASE QUANTITY	DELIVERY MODE
TPC10AHM3/86A ⁽¹⁾	0.10	86A	1500	7" diameter plastic tape and reel
TPC10AHM3/87A ⁽¹⁾	0.10	87A	6500	13" diameter plastic tape and reel

Note

⁽¹⁾ Automotive grade

RATINGS AND CHARACTERISTICS CURVES

($T_A = 25\text{ }^\circ\text{C}$ unless otherwise noted)

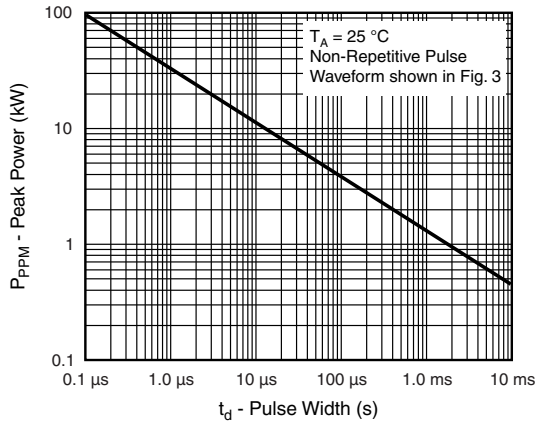

Fig. 1 - Peak Pulse Power Rating Curve

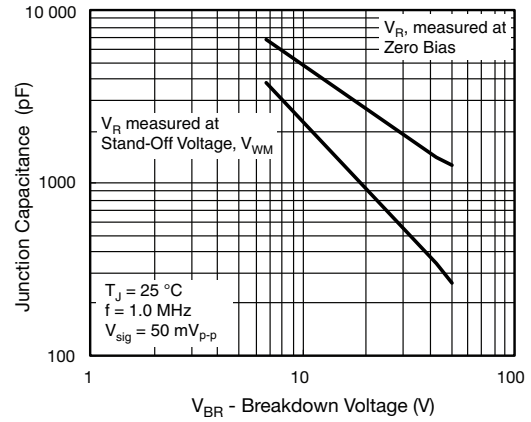

Fig. 4 - Typical Junction Capacitance

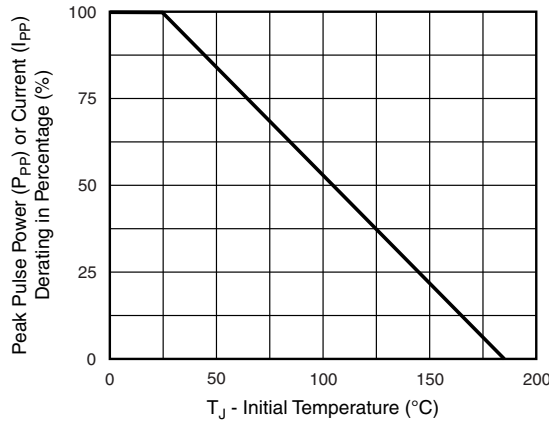

Fig. 2 - Pulse Power or Current vs. Initial Junction Temperature

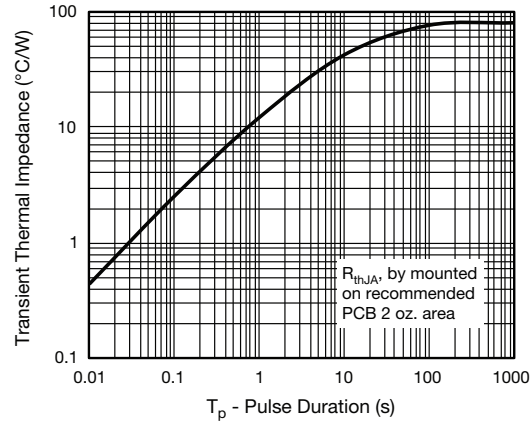

Fig. 5 - Typical Transient Thermal Impedance

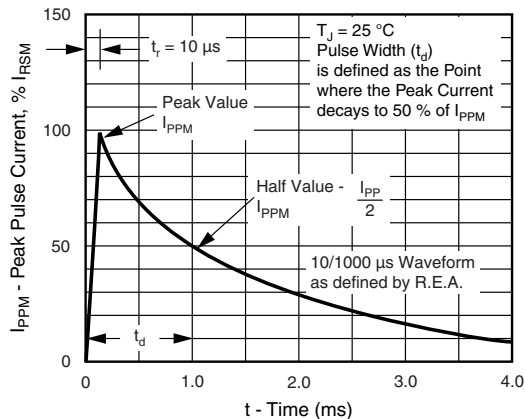
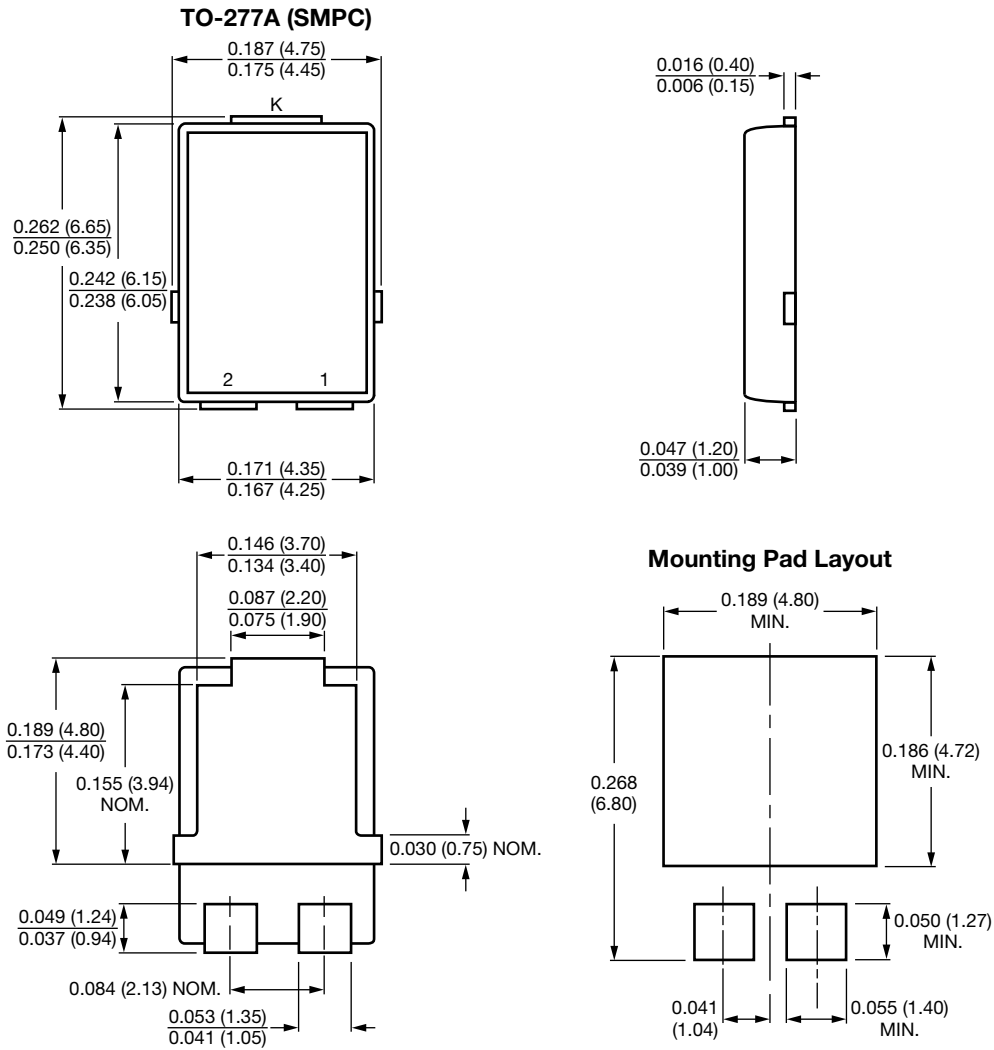

Fig. 3 - Pulse Waveform



PACKAGE OUTLINE DIMENSIONS in inches (millimeters)





Disclaimer

ALL PRODUCT, PRODUCT SPECIFICATIONS AND DATA ARE SUBJECT TO CHANGE WITHOUT NOTICE TO IMPROVE RELIABILITY, FUNCTION OR DESIGN OR OTHERWISE.

Vishay Intertechnology, Inc., its affiliates, agents, and employees, and all persons acting on its or their behalf (collectively, "Vishay"), disclaim any and all liability for any errors, inaccuracies or incompleteness contained in any datasheet or in any other disclosure relating to any product.

Vishay makes no warranty, representation or guarantee regarding the suitability of the products for any particular purpose or the continuing production of any product. To the maximum extent permitted by applicable law, Vishay disclaims (i) any and all liability arising out of the application or use of any product, (ii) any and all liability, including without limitation special, consequential or incidental damages, and (iii) any and all implied warranties, including warranties of fitness for particular purpose, non-infringement and merchantability.

Statements regarding the suitability of products for certain types of applications are based on Vishay's knowledge of typical requirements that are often placed on Vishay products in generic applications. Such statements are not binding statements about the suitability of products for a particular application. It is the customer's responsibility to validate that a particular product with the properties described in the product specification is suitable for use in a particular application. Parameters provided in datasheets and/or specifications may vary in different applications and performance may vary over time. All operating parameters, including typical parameters, must be validated for each customer application by the customer's technical experts. Product specifications do not expand or otherwise modify Vishay's terms and conditions of purchase, including but not limited to the warranty expressed therein.

Except as expressly indicated in writing, Vishay products are not designed for use in medical, life-saving, or life-sustaining applications or for any other application in which the failure of the Vishay product could result in personal injury or death. Customers using or selling Vishay products not expressly indicated for use in such applications do so at their own risk. Please contact authorized Vishay personnel to obtain written terms and conditions regarding products designed for such applications.

No license, express or implied, by estoppel or otherwise, to any intellectual property rights is granted by this document or by any conduct of Vishay. Product names and markings noted herein may be trademarks of their respective owners.

Material Category Policy

Vishay Intertechnology, Inc. hereby certifies that all its products that are identified as RoHS-Compliant fulfill the definitions and restrictions defined under Directive 2011/65/EU of The European Parliament and of the Council of June 8, 2011 on the restriction of the use of certain hazardous substances in electrical and electronic equipment (EEE) - recast, unless otherwise specified as non-compliant.

Please note that some Vishay documentation may still make reference to RoHS Directive 2002/95/EC. We confirm that all the products identified as being compliant to Directive 2002/95/EC conform to Directive 2011/65/EU.

Vishay Intertechnology, Inc. hereby certifies that all its products that are identified as Halogen-Free follow Halogen-Free requirements as per JEDEC JS709A standards. Please note that some Vishay documentation may still make reference to the IEC 61249-2-21 definition. We confirm that all the products identified as being compliant to IEC 61249-2-21 conform to JEDEC JS709A standards.



Компания «ЭлектроПласт» предлагает заключение долгосрочных отношений при поставках импортных электронных компонентов на взаимовыгодных условиях!

Наши преимущества:

- Оперативные поставки широкого спектра электронных компонентов отечественного и импортного производства напрямую от производителей и с крупнейших мировых складов;
- Поставка более 17-ти миллионов наименований электронных компонентов;
- Поставка сложных, дефицитных, либо снятых с производства позиций;
- Оперативные сроки поставки под заказ (от 5 рабочих дней);
- Экспресс доставка в любую точку России;
- Техническая поддержка проекта, помощь в подборе аналогов, поставка прототипов;
- Система менеджмента качества сертифицирована по Международному стандарту ISO 9001;
- Лицензия ФСБ на осуществление работ с использованием сведений, составляющих государственную тайну;
- Поставка специализированных компонентов (Xilinx, Altera, Analog Devices, Intersil, Interpoint, Microsemi, Aeroflex, Peregrine, Syfer, Eurofarad, Texas Instrument, Miteq, Cobham, E2V, MA-COM, Hittite, Mini-Circuits, General Dynamics и др.);

Помимо этого, одним из направлений компании «ЭлектроПласт» является направление «Источники питания». Мы предлагаем Вам помощь Конструкторского отдела:

- Подбор оптимального решения, техническое обоснование при выборе компонента;
- Подбор аналогов;
- Консультации по применению компонента;
- Поставка образцов и прототипов;
- Техническая поддержка проекта;
- Защита от снятия компонента с производства.



Как с нами связаться

Телефон: 8 (812) 309 58 32 (многоканальный)

Факс: 8 (812) 320-02-42

Электронная почта: org@eplast1.ru

Адрес: 198099, г. Санкт-Петербург, ул. Калинина, дом 2, корпус 4, литера А.