

# Surface Mount PAR<sup>®</sup> Transient Voltage Suppressors

High Temperature Stability and High Reliability Conditions

## eSMP<sup>®</sup> Series



**TO-277A (SMPC)**

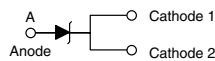

| PRIMARY CHARACTERISTICS |                  |
|-------------------------|------------------|
| $V_{WM}$                | 5.50 V to 43.6 V |
| $V_{BR}$                | 6.8 V to 51 V    |
| $P_{PPM}$               | 1500 W           |
| $T_J$ max.              | 185 °C           |
| Polarity                | Uni-directional  |
| Package                 | TO-277A (SMPC)   |

### TYPICAL APPLICATIONS

Use in sensitive electronics protection against voltage transients induced by inductive load switching and lighting on ICs, MOSFET, signal lines of sensor units for consumer, computer, industrial, automotive, and telecommunication.

### FEATURES

- Junction passivation optimized design passivated anisotropic rectifier technology
- $T_J = 185$  °C capability suitable for high reliability and automotive requirement
- Very low profile - typical height of 1.1 mm
- Ideal for automated placement
- Uni-direction only
- Excellent clamping capability
- Low incremental surge resistance
- Very fast response time
- Meets MSL level 1, per J-STD-020
- AEC-Q101 qualified
- Material categorization: For definitions of compliance please see [www.vishay.com/doc?99912](http://www.vishay.com/doc?99912)

AUTOMOTIVE  
GRADE  
Available



**RoHS**  
COMPLIANT  
HALOGEN  
**FREE**

### MECHANICAL DATA

**Case:** TO-277A (SMPC)

Molding compound meets UL 94 V-0 flammability rating Base P/NHM3 - halogen-free, RoHS-compliant, and automotive grade

**Terminals:** Matte tin plated leads, solderable per J-STD-002 and JESD 22-B102

HM3 suffix meets JESD 201 class 2 whisker test

| MAXIMUM RATINGS ( $T_A = 25$ °C, unless otherwise noted)                          |                |                |      |
|---|----------------|----------------|------|
| PARAMETER   | SYMBOL         | VALUE          | UNIT |
| Peak power dissipation with a 10/1000 $\mu$ s waveform (fig. 3) <sup>(1)(2)</sup> | $P_{PPM}$      | 1500           | W    |
| Peak power pulse current with a 10/1000 $\mu$ s waveform (fig. 1) <sup>(1)</sup>  | $I_{PPM}$      | See next table | A    |
| Peak forward surge current 8.3 ms single half sine-wave <sup>(2)</sup>            | $I_{FSM}$      | 200            | A    |
| Maximum instantaneous forward voltage at 100 A <sup>(3)</sup>                     | $V_F$          | 3.5            | V    |
| Operating junction and storage temperature range                                  | $T_J, T_{STG}$ | - 65 to + 185  | °C   |

### Notes

<sup>(1)</sup> Non-repetitive current pulse, per fig. 3 and derated above  $T_A = 25$  °C per fig. 2

<sup>(2)</sup> Measured on 8.3 ms single half sine-wave, or equivalent square wave, duty cycle = 4 pulses per minute maximum

<sup>(3)</sup> Pulse test: 300  $\mu$ s pulse width, 1 % duty cycle



| ELECTRICAL CHARACTERISTICS (T <sub>A</sub> = 25 °C, unless otherwise noted) |                     |  |      |                                  |                                       |  |  |  |   |
|---|---------------------|--|------|----------------------------------|---------------------------------------|--|--|--|---|
| DEVICE TYPE   | DEVICE MARKING CODE | BREAKDOWN VOLTAGE V <sub>BR</sub> <sup>(1)</sup> AT I <sub>T</sub> (V) |      | TEST CURRENT I <sub>T</sub> (mA) | STAND-OFF VOLTAGE V <sub>WM</sub> (V) | MAXIMUM REVERSE LEAKAGE AT V <sub>WM</sub> I <sub>R</sub> (μA) | MAXIMUM REVERSE LEAKAGE AT V <sub>WM</sub> T <sub>J</sub> = 150 °C I <sub>D</sub> (μA) | MAXIMUM PEAK PULSE SURGE CURRENT I <sub>PPM</sub> <sup>(2)</sup> (A) | MAXIMUM CLAMPING VOLTAGE AT I <sub>PPM</sub> V <sub>C</sub> (V) |
|   |                     | MIN.   | MAX. |                                  |                                       |  |  |  |   |
| TPC6.8  | DDP                 | 6.12   | 7.48 | 10                               | 5.50                                  | 1500   | 10 000   | 139  | 10.8  |
| TPC6.8A   | DEP                 | 6.45   | 7.14 | 10                               | 5.80                                  | 1500   | 10 000   | 143  | 10.5  |
| TPC7.5  | DFP                 | 6.75   | 8.25 | 10                               | 6.05                                  | 500  | 5000   | 128  | 11.7  |
| TPC7.5A   | DGP                 | 7.13   | 7.88 | 10                               | 6.40                                  | 500  | 5000   | 133  | 11.3  |
| TPC8.2  | DHP                 | 7.38   | 9.02 | 10                               | 6.63                                  | 200  | 2000   | 120  | 12.5  |
| TPC8.2A   | DKP                 | 7.79   | 8.61 | 10                               | 7.02                                  | 200  | 2000   | 124  | 12.1  |
| TPC9.1  | DLP                 | 8.19   | 10.0 | 1.0                              | 7.37                                  | 50   | 500  | 109  | 13.8  |
| TPC9.1A   | DMP                 | 8.65   | 9.55 | 1.0                              | 7.78                                  | 50   | 500  | 112  | 13.4  |
| TPC10   | DNP                 | 9.0  | 11.0 | 1.0                              | 8.10                                  | 20   | 200  | 100  | 15.0  |
| TPC10A  | DPP                 | 9.5  | 10.5 | 1.0                              | 8.55                                  | 20   | 200  | 103  | 14.5  |
| TPC11   | DQP                 | 9.9  | 12.1 | 1.0                              | 8.92                                  | 5.0  | 50   | 92.6   | 16.2  |
| TPC11A  | DRP                 | 10.5   | 11.6 | 1.0                              | 9.40                                  | 5.0  | 50   | 96.2   | 15.6  |
| TPC12   | DSP                 | 10.8   | 13.2 | 1.0                              | 9.72                                  | 2.0  | 10   | 86.7   | 17.3  |
| TPC12A  | DTP                 | 11.4   | 12.6 | 1.0                              | 10.2                                  | 2.0  | 10   | 89.8   | 16.7  |
| TPC13   | DUP                 | 11.7   | 14.3 | 1.0                              | 10.5                                  | 2.0  | 10   | 78.9   | 19.0  |
| TPC13A  | DVP                 | 12.4   | 13.7 | 1.0                              | 11.1                                  | 2.0  | 10   | 82.4   | 18.2  |
| TPC15   | DWP                 | 13.5   | 16.5 | 1.0                              | 12.1                                  | 1.0  | 10   | 68.2   | 22.0  |
| TPC15A  | DXP                 | 14.3   | 15.8 | 1.0                              | 12.8                                  | 1.0  | 10   | 70.8   | 21.2  |
| TPC16   | DYP                 | 14.4   | 17.6 | 1.0                              | 12.9                                  | 1.0  | 10   | 63.8   | 23.5  |
| TPC16A  | DZP                 | 15.2   | 16.8 | 1.0                              | 13.6                                  | 1.0  | 10   | 66.7   | 22.5  |
| TPC18   | EDP                 | 16.2   | 19.8 | 1.0                              | 14.5                                  | 1.0  | 10   | 56.6   | 26.5  |
| TPC18A  | EEP                 | 17.1   | 18.9 | 1.0                              | 15.3                                  | 1.0  | 10   | 59.5   | 25.2  |
| TPC20   | EFP                 | 18.0   | 22.0 | 1.0                              | 16.2                                  | 1.0  | 10   | 51.5   | 29.1  |
| TPC20A  | EGP                 | 19.0   | 21.0 | 1.0                              | 17.1                                  | 1.0  | 10   | 54.2   | 27.7  |
| TPC22   | EHP                 | 19.8   | 24.2 | 1.0                              | 17.8                                  | 1.0  | 10   | 47.0   | 31.9  |
| TPC22A  | EKP                 | 20.9   | 23.1 | 1.0                              | 18.8                                  | 1.0  | 10   | 49.0   | 30.6  |
| TPC24   | ELP                 | 21.6   | 26.4 | 1.0                              | 19.4                                  | 1.0  | 10   | 43.2   | 34.7  |
| TPC24A  | EMP                 | 22.8   | 25.2 | 1.0                              | 20.5                                  | 1.0  | 10   | 45.2   | 33.2  |
| TPC27   | ENP                 | 24.3   | 29.7 | 1.0                              | 21.8                                  | 1.0  | 10   | 38.4   | 39.1  |
| TPC27A  | EPP                 | 25.7   | 28.4 | 1.0                              | 23.1                                  | 1.0  | 10   | 40.0   | 37.5  |
| TPC30   | EQP                 | 27.0   | 33.0 | 1.0                              | 24.3                                  | 1.0  | 10   | 34.5   | 43.5  |
| TPC30A  | ERP                 | 28.5   | 31.5 | 1.0                              | 25.6                                  | 1.0  | 10   | 36.2   | 41.4  |
| TPC33   | ESP                 | 29.7   | 36.3 | 1.0                              | 26.8                                  | 1.0  | 10   | 31.4   | 47.7  |
| TPC33A  | ETP                 | 31.4   | 34.7 | 1.0                              | 28.2                                  | 1.0  | 10   | 32.8   | 45.7  |
| TPC36   | EUP                 | 32.4   | 39.6 | 1.0                              | 29.1                                  | 1.0  | 15   | 28.8   | 52.0  |
| TPC36A  | EVP                 | 34.2   | 37.8 | 1.0                              | 30.8                                  | 1.0  | 15   | 30.1   | 49.9  |
| TPC39   | EWP                 | 35.1   | 42.9 | 1.0                              | 31.6                                  | 1.0  | 15   | 26.6   | 56.4  |
| TPC39A  | EXP                 | 37.1   | 41.0 | 1.0                              | 33.3                                  | 1.0  | 15   | 27.8   | 53.9  |
| TPC43   | EYP                 | 38.7   | 47.3 | 1.0                              | 34.8                                  | 1.0  | 20   | 24.2   | 61.9  |
| TPC43A  | EZP                 | 40.9   | 45.2 | 1.0                              | 36.8                                  | 1.0  | 20   | 25.3   | 59.3  |
| TPC47A  | FEP                 | 44.7   | 49.4 | 1.0                              | 40.2                                  | 1.0  | 20   | 23.1   | 64.8  |
| TPC51A  | FGP                 | 48.5   | 53.6 | 1.0                              | 43.6                                  | 1.0  | 20   | 21.4   | 70.1  |

Notes

- (1) V<sub>BR</sub> measured after I<sub>T</sub> applied for 300 μs, I<sub>T</sub> = square wave pulse or equivalent
- (2) Surge current waveform per fig. 3 and derated per fig. 2
- (3) All terms and symbols are consistent with ANSI/IEEE C62.35



| ORDERING INFORMATION (Example) |                 |                        |               |                                    |
|--------------------------------|-----------------|------------------------|---------------|------------------------------------|
| PREFERRED P/N                  | UNIT WEIGHT (g) | PREFERRED PACKAGE CODE | BASE QUANTITY | DELIVERY MODE                      |
| TPC10AHM3/86A <sup>(1)</sup>   | 0.10            | 86A                    | 1500          | 7" diameter plastic tape and reel  |
| TPC10AHM3/87A <sup>(1)</sup>   | 0.10            | 87A                    | 6500          | 13" diameter plastic tape and reel |

**Note**

<sup>(1)</sup> Automotive grade

**RATINGS AND CHARACTERISTICS CURVES**

(T<sub>A</sub> = 25 °C unless otherwise noted)

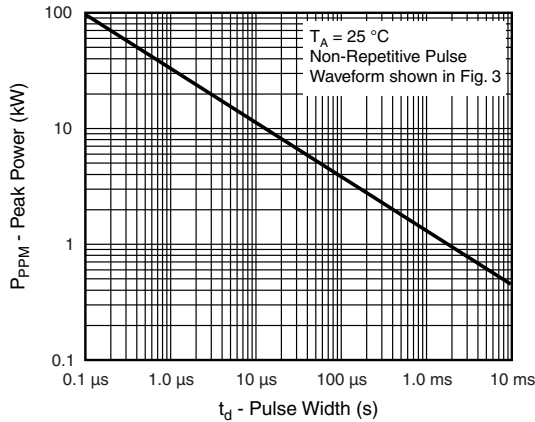

Fig. 1 - Peak Pulse Power Rating Curve

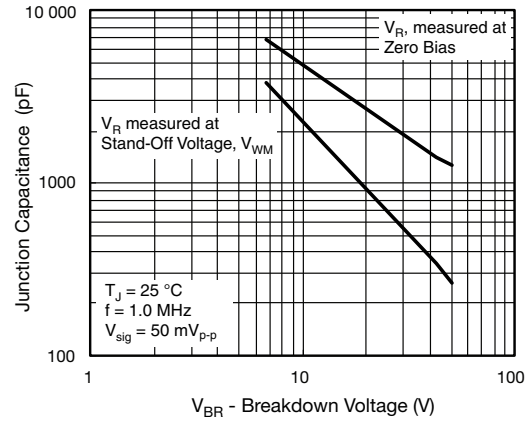

Fig. 4 - Typical Junction Capacitance

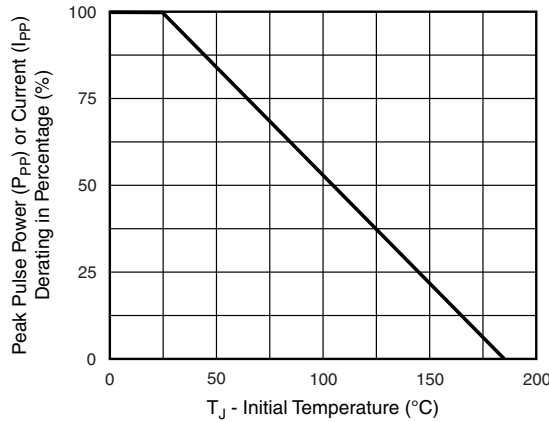

Fig. 2 - Pulse Power or Current vs. Initial Junction Temperature

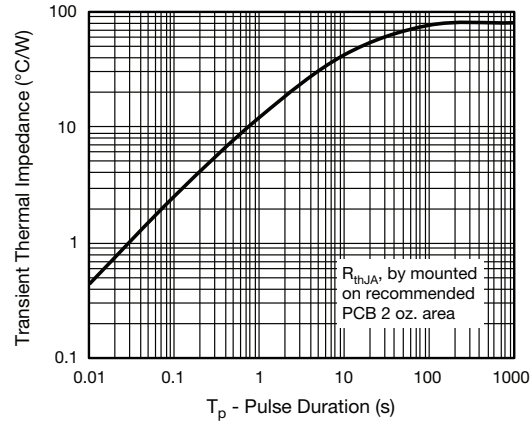

Fig. 5 - Typical Transient Thermal Impedance

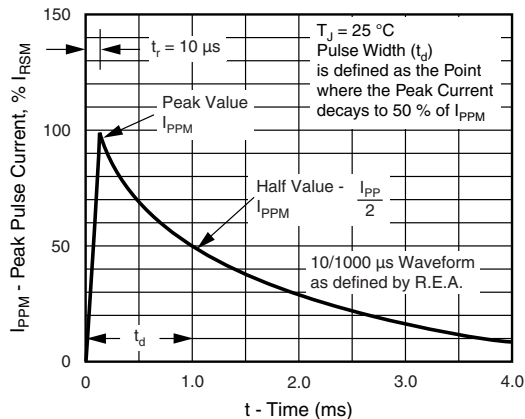
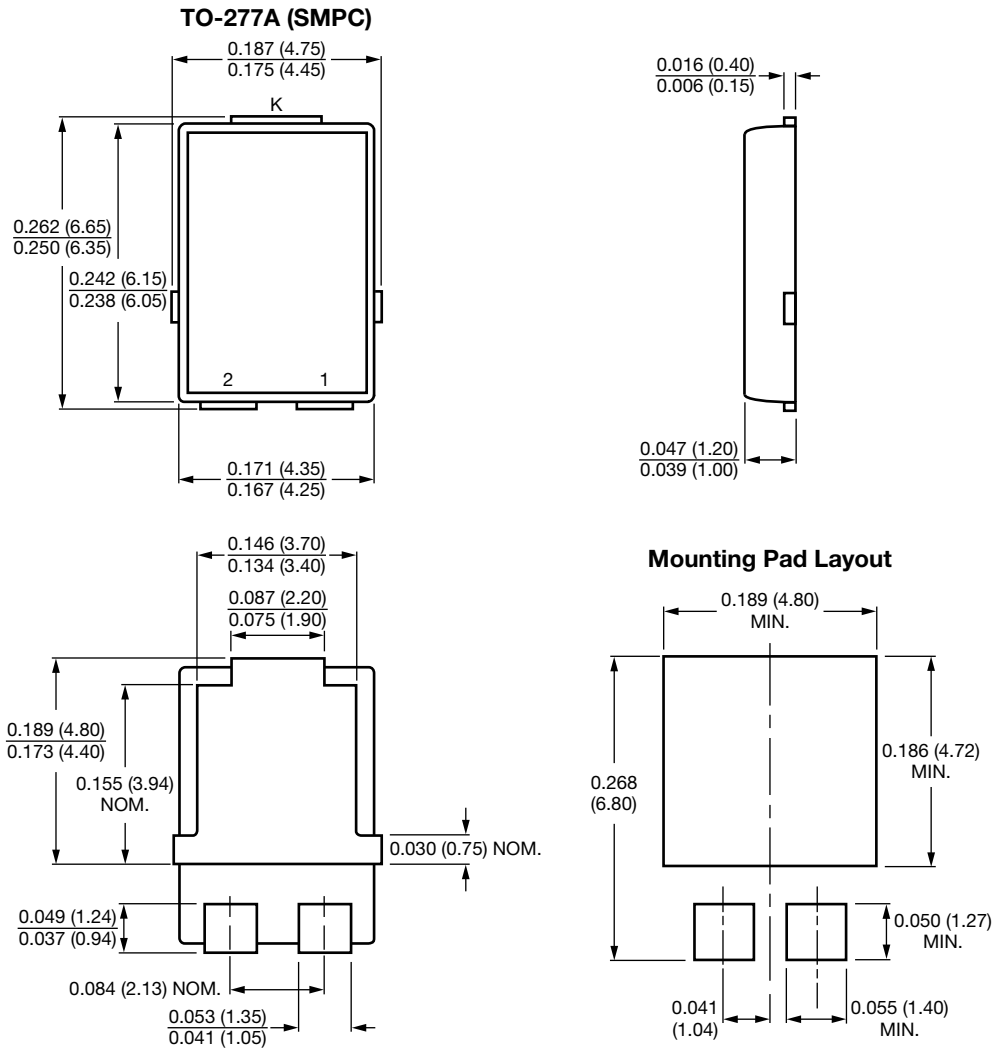

Fig. 3 - Pulse Waveform



### PACKAGE OUTLINE DIMENSIONS in inches (millimeters)





## Disclaimer

ALL PRODUCT, PRODUCT SPECIFICATIONS AND DATA ARE SUBJECT TO CHANGE WITHOUT NOTICE TO IMPROVE RELIABILITY, FUNCTION OR DESIGN OR OTHERWISE.

Vishay Intertechnology, Inc., its affiliates, agents, and employees, and all persons acting on its or their behalf (collectively, "Vishay"), disclaim any and all liability for any errors, inaccuracies or incompleteness contained in any datasheet or in any other disclosure relating to any product.

Vishay makes no warranty, representation or guarantee regarding the suitability of the products for any particular purpose or the continuing production of any product. To the maximum extent permitted by applicable law, Vishay disclaims (i) any and all liability arising out of the application or use of any product, (ii) any and all liability, including without limitation special, consequential or incidental damages, and (iii) any and all implied warranties, including warranties of fitness for particular purpose, non-infringement and merchantability.

Statements regarding the suitability of products for certain types of applications are based on Vishay's knowledge of typical requirements that are often placed on Vishay products in generic applications. Such statements are not binding statements about the suitability of products for a particular application. It is the customer's responsibility to validate that a particular product with the properties described in the product specification is suitable for use in a particular application. Parameters provided in datasheets and/or specifications may vary in different applications and performance may vary over time. All operating parameters, including typical parameters, must be validated for each customer application by the customer's technical experts. Product specifications do not expand or otherwise modify Vishay's terms and conditions of purchase, including but not limited to the warranty expressed therein.

Except as expressly indicated in writing, Vishay products are not designed for use in medical, life-saving, or life-sustaining applications or for any other application in which the failure of the Vishay product could result in personal injury or death. Customers using or selling Vishay products not expressly indicated for use in such applications do so at their own risk. Please contact authorized Vishay personnel to obtain written terms and conditions regarding products designed for such applications.

No license, express or implied, by estoppel or otherwise, to any intellectual property rights is granted by this document or by any conduct of Vishay. Product names and markings noted herein may be trademarks of their respective owners.

## Material Category Policy

**Vishay Intertechnology, Inc. hereby certifies that all its products that are identified as RoHS-Compliant fulfill the definitions and restrictions defined under Directive 2011/65/EU of The European Parliament and of the Council of June 8, 2011 on the restriction of the use of certain hazardous substances in electrical and electronic equipment (EEE) - recast, unless otherwise specified as non-compliant.**

**Please note that some Vishay documentation may still make reference to RoHS Directive 2002/95/EC. We confirm that all the products identified as being compliant to Directive 2002/95/EC conform to Directive 2011/65/EU.**

**Vishay Intertechnology, Inc. hereby certifies that all its products that are identified as Halogen-Free follow Halogen-Free requirements as per JEDEC JS709A standards. Please note that some Vishay documentation may still make reference to the IEC 61249-2-21 definition. We confirm that all the products identified as being compliant to IEC 61249-2-21 conform to JEDEC JS709A standards.**



Компания «ЭлектроПласт» предлагает заключение долгосрочных отношений при поставках импортных электронных компонентов на взаимовыгодных условиях!

Наши преимущества:

- Оперативные поставки широкого спектра электронных компонентов отечественного и импортного производства напрямую от производителей и с крупнейших мировых складов;
- Поставка более 17-ти миллионов наименований электронных компонентов;
- Поставка сложных, дефицитных, либо снятых с производства позиций;
- Оперативные сроки поставки под заказ (от 5 рабочих дней);
- Экспресс доставка в любую точку России;
- Техническая поддержка проекта, помощь в подборе аналогов, поставка прототипов;
- Система менеджмента качества сертифицирована по Международному стандарту ISO 9001;
- Лицензия ФСБ на осуществление работ с использованием сведений, составляющих государственную тайну;
- Поставка специализированных компонентов (Xilinx, Altera, Analog Devices, Intersil, Interpoint, Microsemi, Aeroflex, Peregrine, Syfer, Eurofarad, Texas Instrument, Miteq, Cobham, E2V, MA-COM, Hittite, Mini-Circuits, General Dynamics и др.);

Помимо этого, одним из направлений компании «ЭлектроПласт» является направление «Источники питания». Мы предлагаем Вам помощь Конструкторского отдела:

- Подбор оптимального решения, техническое обоснование при выборе компонента;
- Подбор аналогов;
- Консультации по применению компонента;
- Поставка образцов и прототипов;
- Техническая поддержка проекта;
- Защита от снятия компонента с производства.



#### Как с нами связаться

**Телефон:** 8 (812) 309 58 32 (многоканальный)

**Факс:** 8 (812) 320-02-42

**Электронная почта:** [org@eplast1.ru](mailto:org@eplast1.ru)

**Адрес:** 198099, г. Санкт-Петербург, ул. Калинина, дом 2, корпус 4, литера А.