

ISL6744A

Intermediate Bus PWM Controller

FN6554
Rev.1.00
Aug 25, 2017

The [ISL6744A](#) is a low cost, primary side, double-ended controller intended for applications using full and half-bridge topologies for unregulated DC/DC converters. It is a voltage-mode PWM controller designed for half-bridge and full-bridge power supplies. It provides precise switching frequency control, adjustable soft-start, precise dead time control with dead times as low as 35ns, and overcurrent shutdown. The ISL6744A is identical to the ISL6744, but is optimized for higher noise environments.

Low start-up and operating currents allow for easy biasing in both AC/DC and DC/DC applications. This advanced BiCMOS design features low start-up and operating currents, adjustable switching frequency up to 1MHz, 1A FET drivers, and very low propagation delays for a fast response to overcurrent faults.

Related Literature

- For a full list of related documents, visit our website
 - [ISL6744A](#) product page

Features

- Precision duty cycle and dead time control
- 100 μ A start-up current
- Adjustable delayed overcurrent shutdown and restart
- Adjustable oscillator frequency up to 2MHz
- 1A MOSFET gate drivers
- Adjustable soft-start
- Internal over-temperature protection
- 35ns control to output propagation delay
- Small size and minimal external component count
- Input undervoltage protection
- Pb-free (RoHS compliant)

Applications

- Telecom and datacom isolated power
- DC transformers
- Bus converters

Contents

1. Overview	3
1.1 Internal Architecture	3
1.2 Typical Application	4
1.3 Ordering Information	5
1.4 Pin Configuration	5
1.5 Pin Descriptions	6
2. Specifications	7
2.1 Absolute Maximum Ratings	7
2.2 Thermal Information	7
2.3 Recommended Operating Conditions	7
2.4 Electrical Specifications	7
3. Typical Performance Curves	9
4. Functional Description	10
4.1 Features	10
4.2 Oscillator	10
4.3 Soft-Start Operation	11
4.4 Gate Drive	11
4.5 Overcurrent Operation	11
4.6 Thermal Protection	11
4.7 Ground Plane Requirements	11
5. Typical Application	12
5.1 Circuit Elements	12
5.2 Design Specifications	12
5.3 Transformer Design	13
5.4 MOSFET Selection	16
5.5 Oscillator Component Selection	17
5.6 Output Filter Design	18
5.7 Current Limit Threshold	19
5.8 Performance	20
5.9 Waveforms	21
6. Component List	23
7. Revision History	24
8. Package Outline Drawing	25
9. About Intersil	27

1. Overview

1.1 Internal Architecture

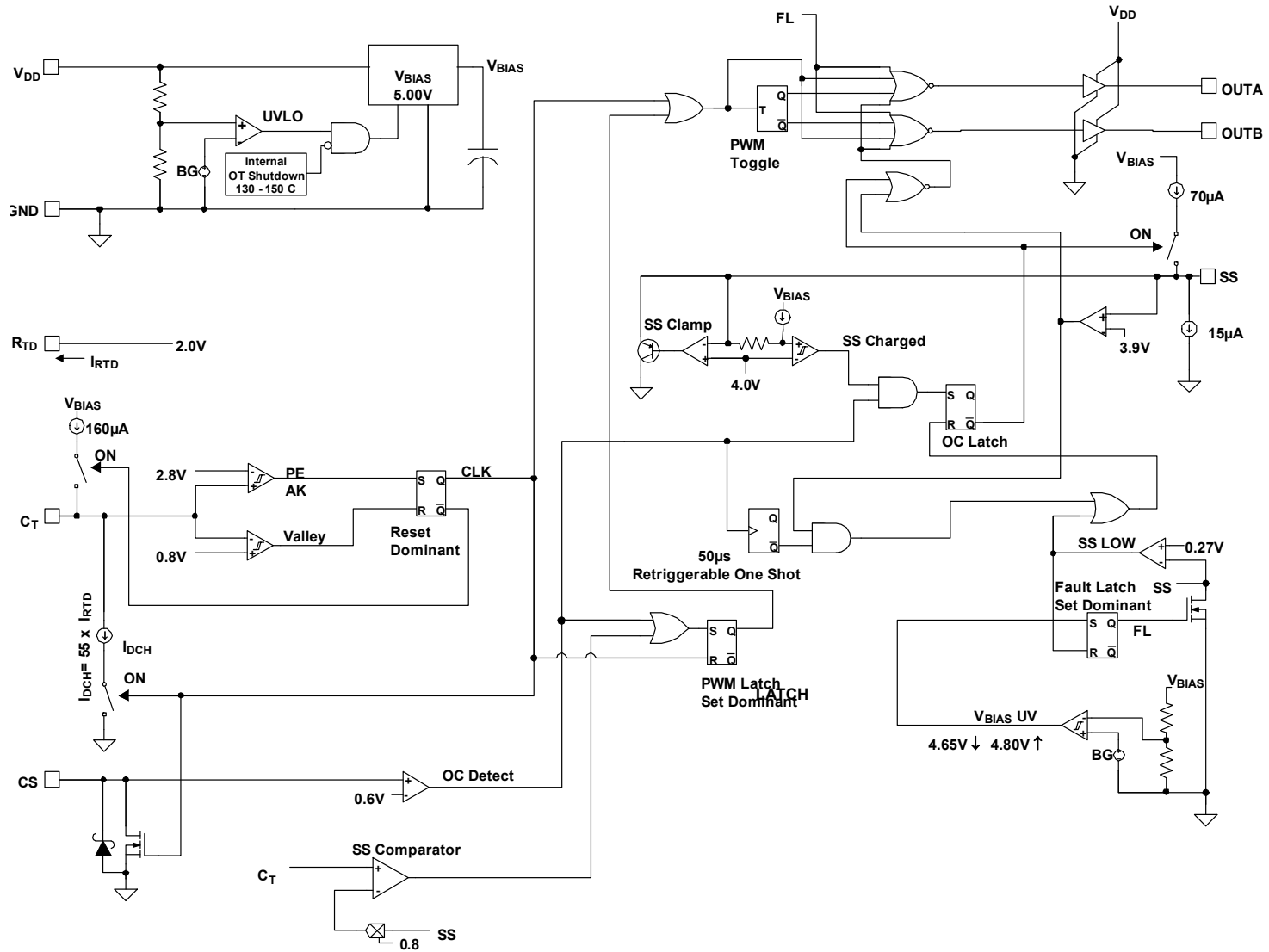

Figure 1. Block Diagram

1.2 Typical Application

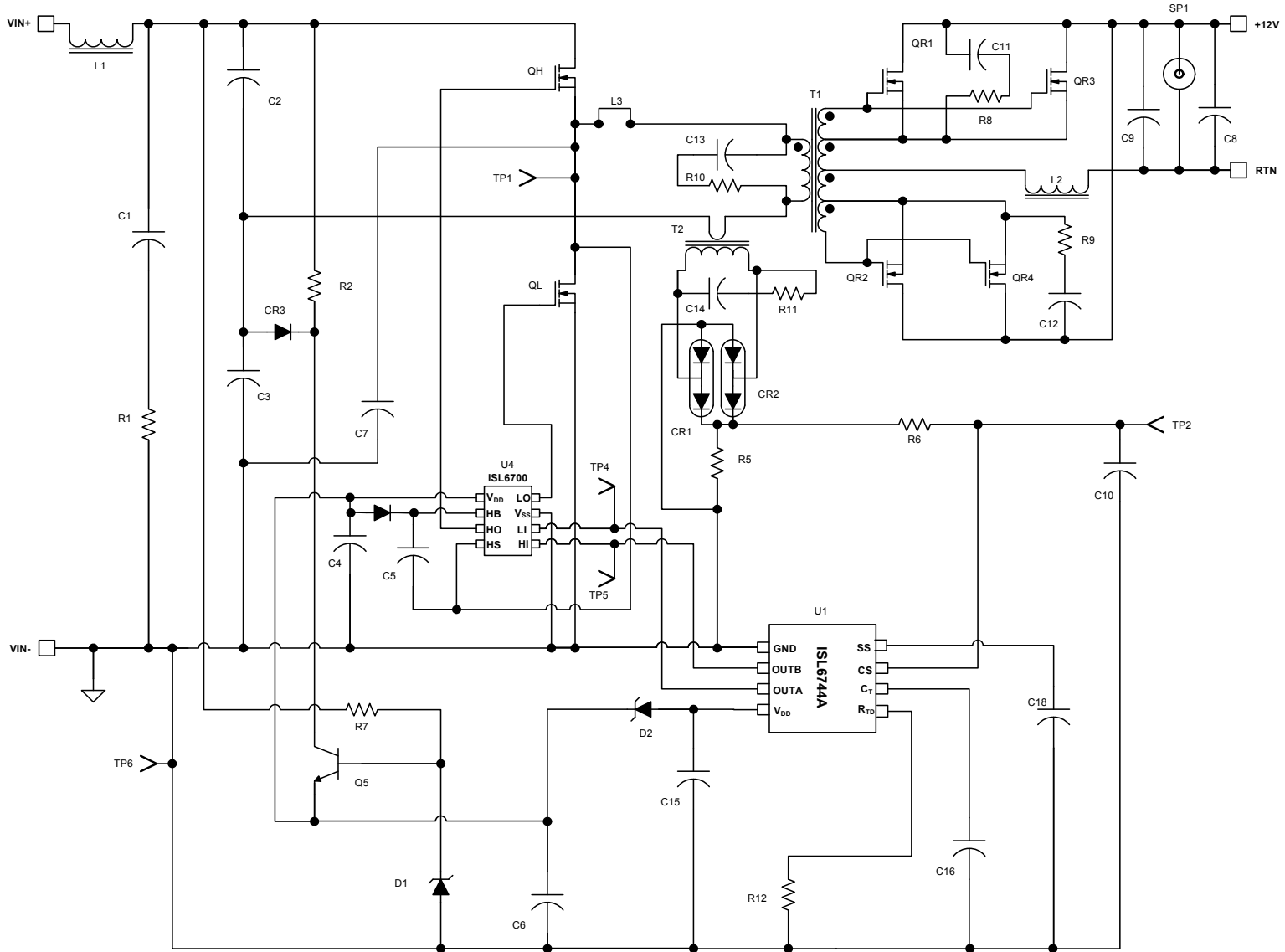

Figure 2. Typical Application Using ISL6744A - 48V Input DC Transformer, 12V at 8A Output

1.3 Ordering Information

Part Number (Notes 1, 2, 3)	Part Marking	Temp. Range (°C)	Package (RoHS Compliant)	Pkg. Dwg. #
ISL6744AAUZ	6744A	-40 to +105	8 Ld MSOP	M8.118
ISL6744AABZ	6744A ABZ	-40 to +105	8 Ld SOIC	M8.15

Notes:

1. Add "-T" suffix for 2.5k for tape and reel option. Refer to [TB347](#) for details on reel specifications.
2. These Intersil Pb-free plastic packaged products employ special Pb-free material sets; molding compounds/die attach materials and 100% matte tin plate PLUS ANNEAL - e3 termination finish, which is RoHS compliant and compatible with both SnPb and Pb-free soldering operations. Intersil Pb-free products are MSL classified at Pb-free peak reflow temperatures that meet or exceed the Pb-free requirements of IPC/JEDEC J STD-020.
3. For Moisture Sensitivity Level (MSL), see the product information page for [ISL6744A](#). For more information on MSL, refer to [TB363](#).

1.4 Pin Configuration

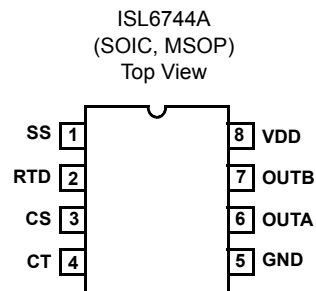

1.5 Pin Descriptions

Pin Name	Pin Number	Description
SS	1	Connect the soft-start timing capacitor between this pin and GND to control the duration of soft-start. The value of the capacitor determines the rate of increase of the duty cycle during start-up, controls the overcurrent shutdown delay, and the overcurrent and short-circuit hiccup restart period.
RTD	2	Oscillator timing capacitor discharge current control pin. A resistor is connected between this pin and GND. The current flowing through the resistor determines the magnitude of the discharge current. The discharge current is nominally 55x this current. The PWM dead time is determined by the timing capacitor discharge duration.
CS	3	<p>The input to the overcurrent protection comparator. The overcurrent comparator threshold is set at 0.600V nominal. The CS pin is shorted to GND at the end of each switching cycle. Depending on the current sensing source impedance, a series input resistor may be required due to the delay between the internal clock and the external power switch.</p> <p>Exceeding the overcurrent threshold will start a delayed shutdown sequence. When an overcurrent condition is detected, the soft-start charge current source is disabled. The soft-start capacitor begins discharging through a 15μA current source, and if it discharges to less than 3.9V (sustained overcurrent threshold), a shutdown condition occurs and the OUTA and OUTB outputs are forced low. When the soft-start voltage reaches 0.27V (reset threshold) a soft-start cycle begins.</p> <p>If the overcurrent condition ceases, and then an additional 50μs period elapses before the shutdown threshold is reached, no shutdown occurs. The SS charging current is re-enabled and the soft-start voltage is allowed to recover.</p>
CT	4	The oscillator timing capacitor is connected between this pin and GND.
GND	5	Reference and power ground for all functions on this device. Due to high peak currents and high frequency operation, a low impedance layout is necessary. Ground planes and short traces are highly recommended.
OUTA	6	Alternate half cycle output stages. Each output is capable of 1A peak current for driving power MOSFETs or MOSFET drivers. Each output provides very low impedance to overshoot and undershoot.
OUTB	7	
VDD	8	<p>The power connection for the IC. To optimize noise immunity, bypass VDD to GND with a ceramic capacitor as close to the VDD and GND pins as possible.</p> <p>The total supply current, I_{DD}, will be dependent on the load applied to outputs OUTA and OUTB. Total I_{DD} current is the sum of the quiescent current and the average output current. Knowing the operating frequency (f_{SW}) and the output loading capacitance charge (Q) per output, the average output current can be calculated from (EQ. 1):</p> $I_{OUT} = 2 \cdot Q \cdot f_{SW} \quad (EQ. 1)$

2. Specifications

2.1 Absolute Maximum Ratings

Parameter	Minimum	Maximum	Unit
Supply Voltage, V_{DD}	-0.3	+20.0	V
OUTA, OUTB	-0.3	V_{DD}	V
Signal Pins	-0.3	5	V
Peak GATE Current		1	A

CAUTION: Do not operate at or near the maximum ratings listed for extended periods of time. Exposure to such conditions may adversely impact product reliability and result in failures not covered by warranty.

2.2 Thermal Information

Thermal Resistance (Typical) (Note 4)	θ_{JA} (°C/W)
8 Ld MSOP Package	128
8 Ld SOIC Package	98

Note:

4. θ_{JA} is measured with the component mounted on a high-effective thermal conductivity test board in free air. Refer to [TB379](#).

Parameter	Minimum	Maximum	Unit
Maximum Junction Temperature	-55	+150	°C
Maximum Storage Temperature Range	-65	+150	°C
Pb-Free Reflow Profile	refer to TB493		

2.3 Recommended Operating Conditions

Parameter	Minimum	Maximum	Unit
Temperature Range	-40	+105	°C
Supply Voltage Range (Typical)	9	16	VDC

2.4 Electrical Specifications

Recommended operating conditions unless otherwise noted. Refer to [Figure 1 on page 3](#) and [Figure 2 on page 4](#). $9V < V_D < 16V$, $R_{TD} = 51.1k\Omega$, $C_T = 470pF$, $T_A = -40^\circ C$ to $+105^\circ C$ [\(Note 5\)](#), Typical values are at $T_A = +25^\circ C$

Parameter	Test Conditions	Min	Typ	Max	Unit
Supply Voltage					
Start-Up Current, I_{DD}	$V_{DD} < \text{START threshold}$	-	-	175	μA
Operating Current, I_{DD}	$R_{LOAD}, C_{OUTA,B} = 0$	-	2.89	-	mA
	$C_{OUTA,B} = 1nF$	-	5	8.5	mA
UVLO START Threshold		5.9	6.3	6.6	V
UVLO STOP Threshold		5.3	5.7	6.3	V
Hysteresis		-	0.6	-	V
Current Sense					
Current Limit Threshold		0.55	0.6	0.65	V
CS to OUT Delay	(Note 6)	-	35	-	ns
CS Sink Current		8	10	-	mA

Recommended operating conditions unless otherwise noted. Refer to [Figure 1 on page 3](#) and [Figure 2 on page 4](#). $9V < V_D < 16V$, $R_{TD} = 51.1k\Omega$, $C_T = 470pF$, $T_A = -40^\circ C$ to $+105^\circ C$ ([Note 5](#)), Typical values are at $T_A = +25^\circ C$ (**Continued**)

Parameter	Test Conditions	Min	Typ	Max	Unit
Input Bias Current		-1	-	1	μA
Pulse Width Modulator					
Minimum Duty Cycle	$V_{ERROR} < C_T$ offset	-	-	0	%
Maximum Duty Cycle	$C_T = 470pF$, $R_{TD} = 51.1k\Omega$	-	94	-	%
	$C_T = 470pF$, $R_{TD} = 1.1k\Omega$ (Note 6)	-	99	-	%
C_T to SS Comparator Input Gain	(Note 6)	-	1	-	V/V
SS to SS Comparator Input Gain	(Note 6)	-	0.8	-	V/V
Oscillator					
Charge Current		143	156	170	μA
R_{TD} Voltage		1.925	2	2.075	V
Discharge Current Gain		45	-	65	$\mu A/\mu A$
C_T Valley Voltage		0.75	0.8	0.85	V
C_T Peak Voltage		2.70	2.80	2.90	V
Soft-Start					
Charging Current		45	-	68	μA
SS Clamp Voltage		3.8	4.0	4.2	V
Overcurrent Shutdown Threshold Voltage	(Note 6)	-	3.9	-	V
Overcurrent Discharge Current		12	15	23	μA
Reset Threshold Voltage	(Note 6)	0.25	0.27	0.30	V
Output					
High Level Output Voltage (V_{OH})	$V_{DD} - V_{OUTA}$ or V_{OUTB} , $I_{OUT} = -100mA$	-	0.5	2.0	V
Low Level Output Voltage (V_{OL})	$I_{OUT} = 100mA$	-	0.5	1.0	V
Rise Time	$C_{GATE} = 1nF$, $V_{DD} = 12V$	-	17	60	ns
Fall Time	$C_{GATE} = 1nF$, $V_{DD} = 12V$	-	20	60	ns
Thermal Protection					
Thermal Shutdown	(Note 6)	-	145	-	$^\circ C$
Thermal Shutdown Clear	(Note 6)	-	130	-	$^\circ C$
Hysteresis, Internal Protection	(Note 6)	-	15	-	$^\circ C$

Notes:

5. Specifications at $-40^\circ C$ and $+105^\circ C$ are established by $+25^\circ C$ test with margin limits.
6. Limits are established by characterization and are not production tested.
7. All voltages measured with respect to GND, unless otherwise specified.

3. Typical Performance Curves

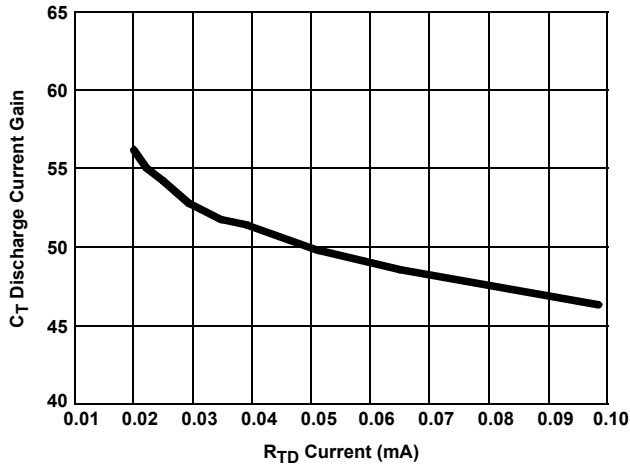

Figure 3. Oscillator C_T Discharge Current Gain

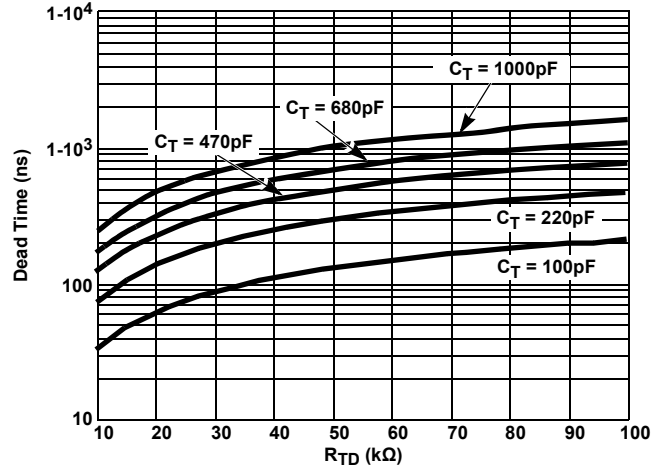

Figure 4. Dead Time vs Capacitance

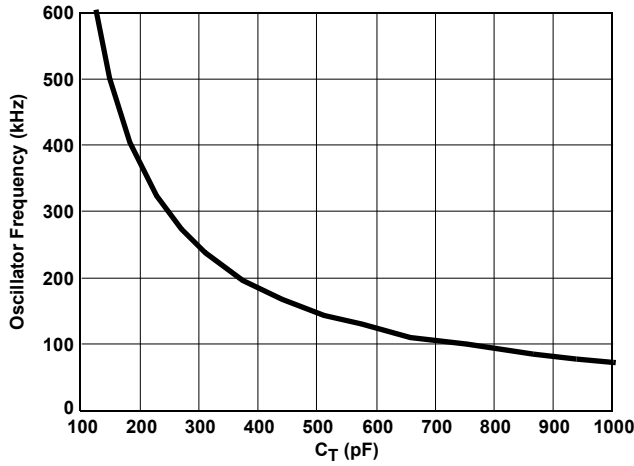

Figure 5. Capacitance vs Oscillator Frequency
(R_{TD} = 49.9kΩ)

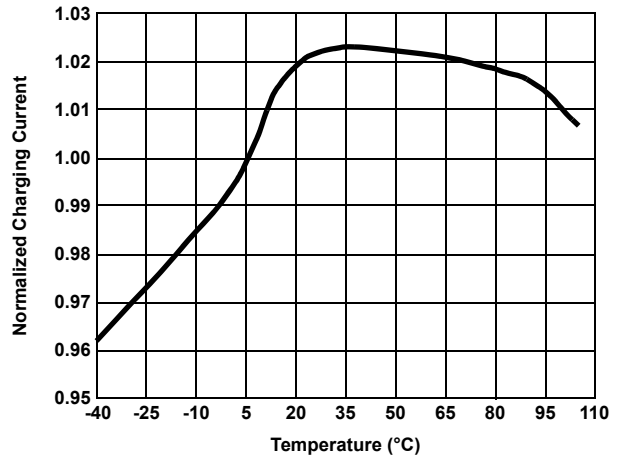

Figure 6. Charge Current vs Temperature

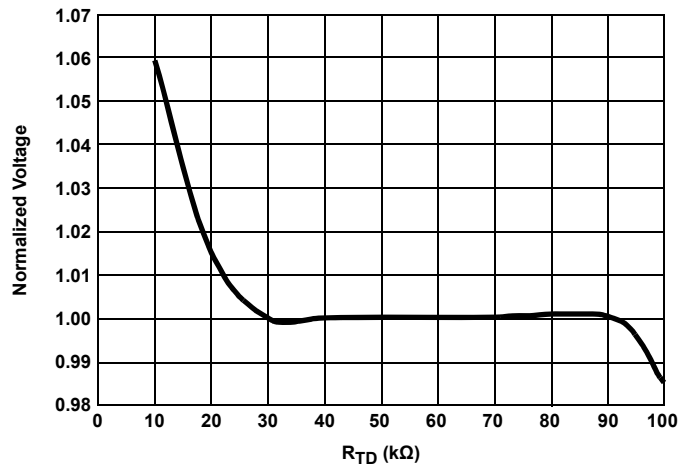

Figure 7. Timing Capacitor Voltage vs R_{TD}

4. Functional Description

4.1 Features

The ISL6744A PWM is an excellent choice for low cost bridge topologies for applications requiring accurate frequency and dead time control. It features 1A FET drivers, adjustable soft-start, overcurrent protection, and internal thermal protection, allowing a highly flexible design with minimal external components.

4.2 Oscillator

The ISL6744A has an oscillator with a frequency range to 2MHz, programmable using a resistor R_{TD} and capacitor C_T .

The switching period is the sum of the timing capacitor charge and discharge durations. The charge duration is determined by C_T and the internal current source (assumed to be $160\mu\text{A}$ in the formula). The discharge duration is determined by R_{TD} and C_T .

$$T_C \approx 1.25 \times 10^4 \cdot C_T \quad \text{s} \quad (\text{EQ. 2})$$

$$T_D \approx \frac{1}{C_T \text{DischargeCurrentGain}} \cdot R_{TD} \cdot C_T \quad \text{s} \quad (\text{EQ. 3})$$

$$T_{OSC} = T_C + T_D = \frac{1}{f_{OSC}} \quad \text{s} \quad (\text{EQ. 4})$$

where T_C and T_D are the approximate charge and discharge times, respectively, T_{OSC} is the oscillator free running period, and f_{OSC} is the oscillator frequency. One output switching cycle requires two oscillator cycles. The actual times are slightly longer than calculated due to internal propagation delays of approximately 5ns per transition. This delay adds directly to the switching duration, and also causes overshoot of the timing capacitor peak and valley voltage thresholds, effectively increasing the peak-to-peak voltage on the timing capacitor. Additionally, if very low charge and discharge currents are used, there will be an increased error due to the input impedance at the C_T pin.

The above formulas help with frequency estimation. Practically, effects such as stray capacitances that affect the overall C_T capacitance, variation in R_{TD} voltage and charge current over-temperature, etc. exist, and are best evaluated in-circuit.

[\(EQ. 2\)](#) follows from the basic capacitor current equation:

$$i = C \times \frac{dV}{dt}$$

In this case, with variation in dV with R_{TD} ([Figure 7](#)), and in charge current ([Figure 6](#)), results from [\(EQ. 2\)](#) would differ from the calculated frequency. The [“Typical Performance Curves” on page 9](#) can be used as a tool along with the above equations to estimate the operating frequency more accurately.

The maximum duty cycle (D) and dead time (DT) can be calculated using [\(EQ. 5\)](#) and [\(EQ. 6\)](#):

$$D = T_C / T_{OSC} \quad (\text{EQ. 5})$$

$$DT = (1 - D) \cdot T_{OSC} \quad \text{s} \quad (\text{EQ. 6})$$

4.3 Soft-Start Operation

The ISL6744A features a soft-start using an external capacitor in conjunction with an internal current source. Soft-start reduces stresses and surge currents during start-up.

The oscillator capacitor signal (C_T) is compared to the soft-start voltage (SS) in the SS comparator, which drives the PWM latch. Duty cycle is limited while the SS voltage is less than 3.5V. The output pulse width increases as the soft-start capacitor voltage increases up to 3.5V. This has the effect of increasing the duty cycle from zero to the maximum pulse width during the soft-start period. When the soft-start voltage exceeds 3.5V, soft-start is complete. Soft-start occurs during start-up and after recovery from an overcurrent shutdown. The soft-start voltage is clamped to 4V.

Please note the capacitance of the soft-start capacitor, C_{SS} . If $C_{SS} \geq 0.1\mu\text{F}$, the user will need to add a resistor in series with the capacitor, $100\Omega/\mu\text{F}$ (100Ω at least; 1k at most).

4.4 Gate Drive

The ISL6744A can source and sink 1A peak current, and can also be used in conjunction with a MOSFET driver, such as the ISL6700, for level shifting. To limit the peak current through the IC, place an external resistor between the totem-pole output of the IC (OUTA or OUTB pin) and the gate of the MOSFET. This small series resistor also damps any oscillations caused by the resonant tank of the parasitic inductances in the traces of the board and the FET's input capacitance.

4.5 Overcurrent Operation

Overcurrent delayed shutdown is enabled after the soft-start cycle is complete. If an overcurrent condition is detected, the soft-start charging current source is disabled and the soft-start capacitor is allowed to discharge through a $15\mu\text{A}$ source. At the same time, a $50\mu\text{s}$ retriggerable one-shot timer is activated. The timer remains active for $50\mu\text{s}$ after the overcurrent condition ceases. If the soft-start capacitor discharges to 3.9V, the output is disabled. This state continues until the soft-start voltage reaches 270mV, at which time a new soft-start cycle is initiated. If the overcurrent condition stops at least $50\mu\text{s}$ prior to the soft-start voltage reaching 3.9V, the soft-start charging currents revert to normal operation and the soft-start voltage is allowed to recover.

4.6 Thermal Protection

An internal temperature sensor protects the device if the junction temperature exceeds $+145^\circ\text{C}$. There is approximately $+15^\circ\text{C}$ of hysteresis.

4.7 Ground Plane Requirements

Careful layout is essential for satisfactory operation of the device. A good ground plane must be employed. V_{DD} should be bypassed directly to GND with good high frequency capacitance.

5. Typical Application

[Figure 2 on page 4](#) features the ISL6744A in an unregulated half-bridge DC/DC converter configuration, often referred to as a DC transformer or bus converter.

The input voltage is $48V \pm 10\%$ DC. The output is a nominal 12V when the input voltage is at 48V. Since this is an unregulated topology, the output voltage will vary proportionately with the input voltage. Load regulation is a function of resistance between the source and the converter output. The output is rated at 8A.

5.1 Circuit Elements

The converter design is comprised of the following functional blocks:

Input Filtering: L1, C1, R1

Half-Bridge Capacitors: C2, C3

Isolation Transformer: T1

Primary Snubber: C13, R10

Start Bias Regulator: CR3, R2, R7, C6, Q5, D1

Supply Bypass Components: C15, C4

Main MOSFET Power Switch: QH, QL

Current Sense Network: T2, CR1, CR2, R5, R6, R11, C10, C14

Control Circuit: U1, C18, C16, D2

Output Rectification and Filtering: QR1, QR2, QR3, QR4, L2, C9, C8

Secondary Snubber: R8, R9, C11, C12

FET Driver: U4

Bootstrap Components for Driver: CR4, C5

ZVS Resonant Delay (Optional): L3, C7

5.2 Design Specifications

The following design requirements were selected for evaluation purposes:

Switching Frequency, f_{SW} : 235kHz

V_{IN} : $48V \pm 10\%$

V_{OUT} : 12V (nominal)

I_{OUT} : 8A (steady state)

P_{OUT} : 100W

Efficiency: 95%

Ripple: 1%

5.3 Transformer Design

The design of a transformer for a half-bridge application is an iterative process. The process requires compromises, and even experienced designers will produce different designs when presented with identical requirements. For clarity, the iterative design process is not presented here.

The abbreviated design process is as follows:

- Select a core geometry suitable for the application. Constraints of height, footprint, mounting preference, and operating environment will affect the core geometry.
- Determine the turns ratio.
- Select suitable core material(s).
- Select the maximum flux density desired for operation.
- Select the core size. Core size is determined by the capability of the core structure to store the required energy, the number of turns that have to be wound, and the wire gauge needed. Often the window area (the space used for the windings) and power loss determine the final core size.
- Determine the maximum desired flux density. Depending on the frequency of operation, the core material selected, and the operating environment, the allowed flux density must be determined. The decision of what flux density to allow is often difficult to determine initially. Usually, the highest flux density that produces an acceptable design is used, but often the winding geometry dictates a larger core than is indicated based on flux density alone.
- Determine the number of primary turns.
- Select the wire gauge for each winding.
- Determine the winding order and insulation requirements.
- Verify the design.

For this application, we have selected a planar structure to achieve a low profile design. A PQ style core was selected because of its round center leg cross section, but many suitable core styles are available.

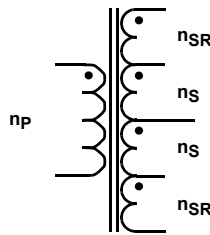

Figure 8. Transformer Schematic

Because the converter is operating as an open loop at nearly 100% duty cycle, the turns ratio, N , is the ratio of the input voltage to the output voltage divided by 2.

$$N = \frac{V_{IN}}{V_{OUT} \cdot 2} = \frac{48}{12 \cdot 2} = 2 \quad (\text{EQ. 7})$$

The factor of 2 in the denominator is due to the half-bridge topology. Only half of the input voltage is applied to the primary of the transformer.

A PC44HPQ20/6 “E-Core” plus a PC44PQ20/3 “I-Core” from TDK were selected for the transformer core. The ferrite material is PC44.

The core parameter of concern for flux density is the effective core cross-sectional area, A_e . For the PQ core pieces selected:

$$A_e = 0.62\text{cm}^2 \text{ or } 6.2\text{e}^{-5}\text{m}^2$$

Using Faraday’s Law, $V = N \, d\Phi/dt$, the number of primary turns can be determined after the maximum flux density is set. An acceptable B_{max} is ultimately determined by the allowable power dissipation in the ferrite material and is influenced by the lossiness of the core, core geometry, operating ambient temperature, and air flow. The TDK datasheet for PC44 material

indicates a core loss factor of $\sim 400 \text{mW/cm}^3$ with a ± 2000 gauss 100kHz sinusoidal excitation. The application uses a 235kHz square wave excitation, so no direct comparison between the application and the data can be made. Interpolation of the data is required. The core volume is approximately 1.6cm^3 , so the estimated core loss is:

$$P_{\text{loss}} \approx \frac{\text{mW}}{\text{cm}^3} \cdot \text{cm}^3 \cdot \frac{f_{\text{act}}}{f_{\text{meas}}} = 0.4 \cdot 1.6 \cdot \frac{200\text{kHz}}{100\text{kHz}} = 1.28 \quad \text{W} \quad (\text{EQ. 8})$$

1.28W of dissipation is significant for a core of this size. Reducing the flux density to 1200 gauss will reduce the dissipation by about the same percentage, or 40%. Evaluate the transformer's performance in the application to determine acceptable dissipation.

From Faraday's Law and using 1200 gauss peak flux density ($\Delta B = 2400$ gauss or 0.24 tesla):

$$N = \frac{V_{\text{IN}} \cdot T_{\text{ON}}}{2 \cdot A_e \cdot \Delta B} = \frac{53 \cdot 2 \cdot 10^{-6}}{2 \cdot 6.2 \cdot 10^{-5} \cdot 0.24} = 3.56 \quad \text{turns} \quad (\text{EQ. 9})$$

Rounding up yields four turns for the primary winding. The peak flux density using four turns is ~ 1100 gauss. From [\(EQ. 7\)](#) on [page 13](#), the number of secondary turns is 2.

The volts/turn for this design ranges from 5.4V at $V_{\text{IN}} = 43\text{V}$ to 6.6V at $V_{\text{IN}} = 53\text{V}$. Therefore, the Synchronous Rectifier (SR) windings may be set at 1 turn each with proper FET selection. Selecting 2 turns for the synchronous rectifier windings would also be acceptable, but the gate drive losses would increase.

Determine the equivalent wire gauge for the planar structure. Since each secondary winding conducts for only 50% of the period, the RMS current is:

$$I_{\text{RMS}} = I_{\text{OUT}} \cdot \sqrt{D} = 10 \cdot \sqrt{0.5} = 7.07 \quad \text{A} \quad (\text{EQ. 10})$$

where D is the duty cycle. Since an FR-4 PWB planar winding structure was selected, the width of the copper traces is limited by the window area width, and the number of layers is limited by the window area height. The PQ core selected has a usable window area width of 0.165 inches. Allowing one turn per layer and 0.020 inches clearance at the edges allows a maximum trace width of 0.125 inches. Using 100 circular mils (c.m.)/A as a guideline for current density, and from [\(EQ. 10\)](#), 707c.m. are required for each of the secondary windings (a circular mil is the area of a circle 0.001 inches in diameter). Converting c.m. to square mils yields 555 mils² (0.785 sq. mils/c.m.). Dividing by the trace width results in a copper thickness of 4.44 mils (0.112mm). Using 1.3 mils/oz. of copper requires a copper weight of 3.4oz. To reduce cost, 3oz. copper was selected.

One layer of each secondary winding also contains the synchronous rectifier winding. For this layer, the secondary trace width is reduced by 0.025 inches to 0.100 inches (0.015 inches for the SR winding trace width and 0.010 inches spacing between the SR winding and the secondary winding).

The choice of copper weight may be validated by calculating the DC copper losses of the secondary winding. Ignoring the terminal and lead-in resistance, the resistance of each layer of the secondary may be approximated using (EQ. 11).

$$R = \frac{2\pi\rho}{t \cdot \ln\left(\frac{r_2}{r_1}\right)} \quad \Omega \quad (\text{EQ. 11})$$

where

R = Winding resistance

ρ = Resistivity of copper = 669e-9 Ω -inches at +20°C

t = Thickness of the copper (3 oz.) = 3.9e-3 inches

r_2 = Outside radius of the copper trace = 0.324 or 0.299 inches

r_1 = Inside radius of the copper trace = 0.199 inches

The winding without the SR winding on the same layer has a DC resistance of 2.21m Ω . The winding that shares the layer with the SR winding has a DC resistance of 2.65m Ω . With the secondary configured as a 4 turn center tapped winding (2 turns each side of the tap), the total DC power loss for the secondary at +20°C is 486mW.

The primary windings have an RMS current of approximately 5A ($I_{OUT} \times N_S/N_P$ at ~ 100% duty cycle). The primary is configured as 2 layers, 2 turns per layer to minimize the winding stack height. Allowing 0.020 inches edge clearance and 0.010 inches between turns yields a trace width of 0.0575 inches. Ignoring the terminal and lead-in resistance, and using (EQ. 11), the inner trace has a resistance of 4.25m Ω , and the outer trace has a resistance of 5.52m Ω . The resistance of the primary then is 19.5m Ω at +20°C. The total DC power loss for the primary at +20°C is 489mW.

Improved efficiency and thermal performance can be achieved by selecting heavier copper weight for the windings. Evaluation in the application will determine its need.

The order and geometry of the windings affects the AC resistance, winding capacitance, and leakage inductance of the finished transformer. To reduce these effects, interleave the windings. The primary winding is placed between the two secondary windings. The winding layout appears as follows:

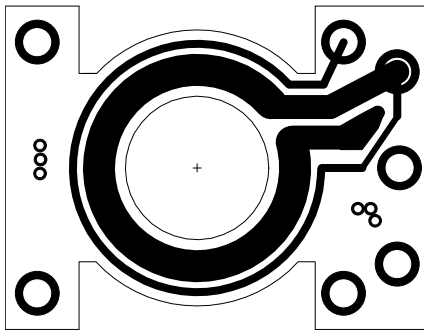

Figure 9. Top Layer: 1 Turn Secondary and SR Windings

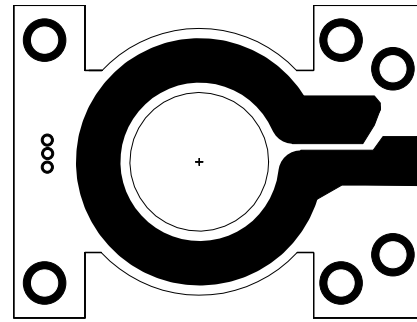

Figure 10. Internal layer 1: 1 Turn Secondary Winding

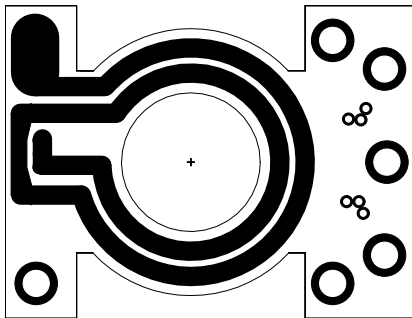

Figure 11. Internal Layer 2: 2 Turns Primary Winding

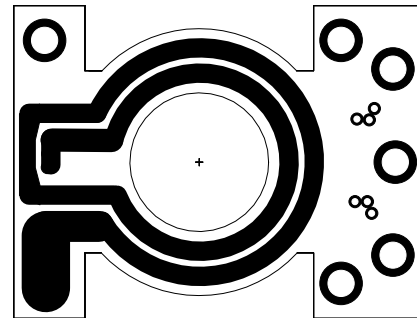

Figure 12. Internal Layer 3: 2 Turns Primary Winding

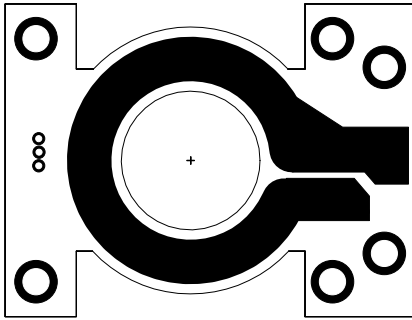

Figure 13. Internal Layer 4: 1 Turn Secondary Winding

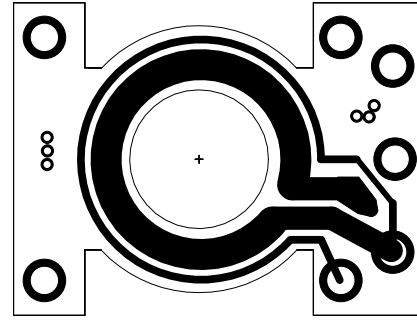

Figure 14. Bottom Layer: 1 Turn Secondary and SR Windings

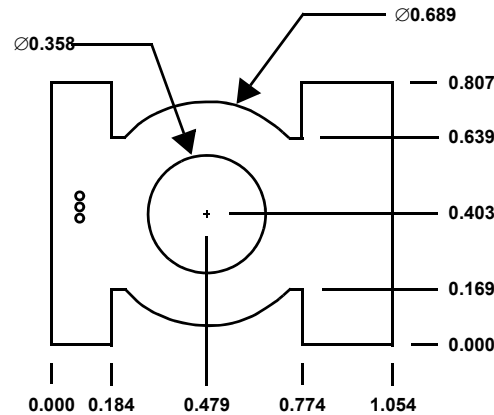

Figure 15. PWB Dimensions

5.4 MOSFET Selection

The criteria for selection of the primary side half-bridge FETs and the secondary side synchronous rectifier FETs is largely based on the current and voltage rating of the device. However, do not ignore the FET drain-source capacitance and gate charge.

The Zero Voltage Switch (ZVS) transition timing is dependent on the transformer's leakage inductance and the capacitance at the node between the upper FET source and the lower FET drain. The node capacitance is comprised of the drain-source capacitance of the FETs and the transformer parasitic capacitance. The leakage inductance and capacitance form an LC resonant tank circuit, which determines the duration of the transition. The amount of energy stored in the LC tank circuit determines the transition voltage amplitude. If the leakage inductance energy is too low, ZVS operation is not possible and near or partial ZVS operation occurs. As the leakage energy increases, the voltage amplitude increases until it is clamped by the FET body diode to ground or V_{IN} , depending on which FET conducts. When the leakage energy exceeds the minimum required for ZVS operation, the voltage is clamped until the energy is transferred. This behavior increases the time window for ZVS operation. However, the transition time and the period of time during which the voltage is clamped reduces the effective duty cycle.

The gate charge affects the switching speed of the FETs. Higher gate charge translates into higher drive requirements and/or slower switching speeds. The energy required to drive the gates is dissipated as heat.

The maximum input voltage, V_{IN} , plus transient voltage, determines the voltage rating required. With a maximum input voltage of 53V for this application, and if we allow a 10% adder for transients, a voltage rating of 60V or higher will suffice.

The RMS current through each primary side FET can be determined from (EQ. 10), substituting 5A of primary current for I_{OUT} (assuming 100% duty cycle). The result is 3.5A RMS. Fairchild FDS3672 FETs, rated at 100V and 7.5A ($r_{DS(ON)} = 22m\Omega$), were selected for the half-bridge switches.

The synchronous rectifier FETs must withstand approximately one half of the input voltage, assuming no switching transients are present. This suggests that a device capable of withstanding at least 30V is required. Empirical testing in the circuit revealed switching transients of 20V were present across the device, indicating that a rating of at least 60V is required.

The RMS current rating of 7.07A for each SR FET requires a low $r_{DS(ON)}$ to minimize conduction losses, which is difficult to find in a 60V device. It was decided to use two devices in parallel to simplify the thermal design. Two Fairchild FDS5670 devices are used in parallel for a total of four SR FETs. The FDS5670 is rated at 60V and 10A ($r_{DS(ON)} = 14m\Omega$).

5.5 Oscillator Component Selection

The desired operating frequency of 235kHz for the converter was established in “[Design Specifications](#)” on page 12. The oscillator frequency operates at twice the frequency of the converter because two clock cycles are required for a complete converter period.

During each oscillator cycle the timing capacitor, C_T , must be charged and discharged. Determining the required discharge time to achieve Zero Voltage Switching (ZVS) is the critical design goal in selecting the timing components. The discharge time sets the dead time between the two outputs, and is the same as ZVS transition time. After the discharge time is determined, the remainder of the period becomes the charge time.

The ZVS transition duration is determined by the transformer’s primary leakage inductance, L_{lk} , by the FET C_{OSS} , by the transformer’s parasitic winding capacitance, and by any other parasitic elements on the node. The parameters may be determined by measurement, calculation, estimate, or by some combination of these methods.

$$t_{zvs} \approx \frac{\pi \sqrt{L_{lk} \cdot (2C_{oss} + C_{xfrmr})}}{2} \quad \text{s} \quad \text{(EQ. 12)}$$

Device output capacitance, C_{OSS} , is non-linear with applied voltage. To determine the equivalent discrete capacitance, C_{fet} , a charge model is used. Using a known current source, the time required to charge the MOSFET drain to the desired operating voltage is determined and the equivalent capacitance is calculated.

$$C_{fet} = \frac{I_{chg} \cdot t}{V} \quad \text{F} \quad \text{(EQ. 13)}$$

After the estimated transition time is determined, it must be verified directly in the application. The transformer leakage inductance was measured at 125nH and the combined capacitance was estimated at 2000pF. Calculations indicate a transition period of ~25ns. Verification of the performance yielded a value of T_D closer to 45ns.

The remainder of the switching half-period is the charge time, T_C , and can be determined using (EQ. 14)

$$T_C = \frac{1}{2 \cdot f_{SW}} - T_D = \frac{1}{2 \cdot 235 \cdot 10^3} - 45 \cdot 10^{-9} = 2.08 \quad \mu\text{s} \quad (\text{EQ. 14})$$

where f_{SW} is the converter switching frequency.

Using [Figure 5 on page 9](#), the capacitor value appropriate to the desired oscillator operating frequency of 470kHz can be selected. A C_T value of 100pF, 150pF, or 220pF is appropriate for this frequency. A value of 150pF was selected.

To obtain the proper value for R_{TD} , (EQ. 3) on [page 10](#) is used. Because there is a 10ns propagation delay in the oscillator circuit, it must be included in the calculation. The value of R_{TD} selected is 10k Ω .

5.6 Output Filter Design

The output filter inductor and capacitor selection is simple and straightforward. Under steady state operating conditions the voltage across the inductor is very small due to the large duty cycle. Voltage is applied across the inductor only during the switch transition time, which is about 45ns in this application. Ignoring the voltage drop across the SR FETs, the voltage across the inductor during the on time with $V_{IN} = 48\text{V}$ is:

$$V_L = V_S - V_{OUT} = \frac{V_{IN} \cdot N_S \cdot (1 - D)}{2N_P} \approx 250 \quad \text{mV} \quad (\text{EQ. 15})$$

where

V_L is the inductor voltage

V_S is the voltage across the secondary winding

V_{OUT} is the output voltage

If a current ramp, ΔI , of 5% of the rated output current is allowed, the minimum inductance required is:

$$L \geq \frac{V_L \cdot T_{ON}}{\Delta I} = \frac{0.25 \cdot 2.08}{0.5} = 1.04 \quad \mu\text{H} \quad (\text{EQ. 16})$$

An inductor value of 1.5 μH , rated for 18A was selected.

With a maximum input voltage of 53V, the maximum output voltage is about 13V. The closest higher voltage rated capacitor is 16V. Under steady state operating conditions the ripple current in the capacitor is small, so it would seem appropriate to have a low ripple current rated capacitor. However, a high rated ripple current capacitor was selected based on the nature of the intended load, multiple buck regulators. To minimize the output impedance of the filter, a SANYO OSCON 16SH150M capacitor in parallel with a 22 μF ceramic capacitor were selected.

5.7 Current Limit Threshold

The current limit threshold is fixed at 0.6V nominal, which is the reference to the overcurrent protection comparator. The current level that corresponds to the overcurrent threshold must be chosen to allow for the dynamic behavior of an open loop converter. In particular, the low inductor ripple current under steady state operation increases significantly as the duty cycle decreases.

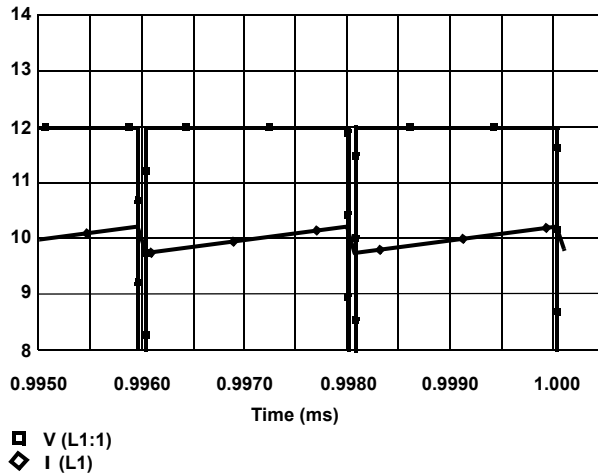

Figure 16. Steady State Secondary Winding Voltage and Inductor Current

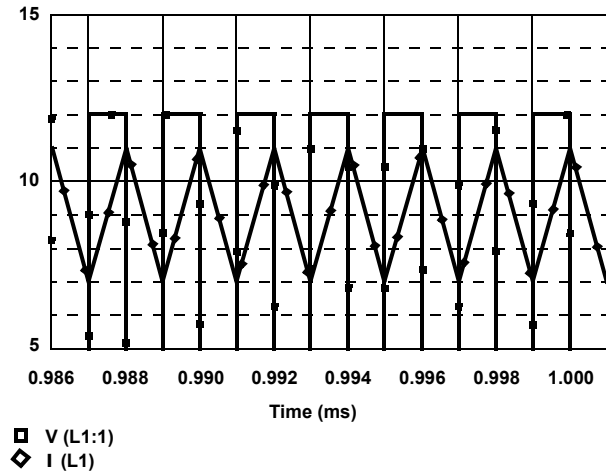

Figure 17. Secondary Winding Voltage and Inductor Current During Current Limit Operation

[Figures 16](#) and [17](#) show the behavior of the inductor ripple under steady state and overcurrent conditions. In this example, the peak current limit is set at 11A. The peak current limit causes the duty cycle to decrease, resulting in a reduction of the average current through the inductor. The implication is that the converter can not supply the same output current in current limit that it can supply under steady state conditions. The peak current limit setpoint must take this behavior into consideration. A 5.11Ω current sense resistor was selected for the rectified secondary of current transformer T2 for the ISL6744Eval 1, corresponding to a peak current limit setpoint of about 11A.

5.8 Performance

The major performance criteria for the converter are efficiency, and to a lesser extent, load regulation. Efficiency, load regulation, and line regulation performance are demonstrated in [Figures 18](#) through [20](#).

As expected, the output voltage varies considerably with line and load when compared to an equivalent converter with a closed loop feedback. However, for applications where tight regulation is not required, such as those applications that use downstream DC/DC converters, this design approach is acceptable.

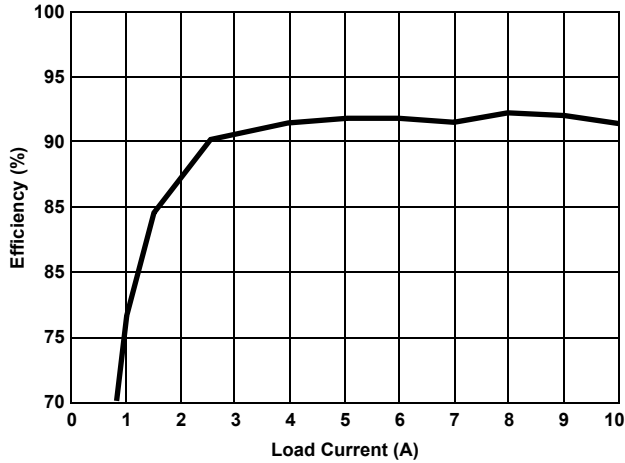

Figure 18. Efficiency vs Load $V_{IN} = 48V$

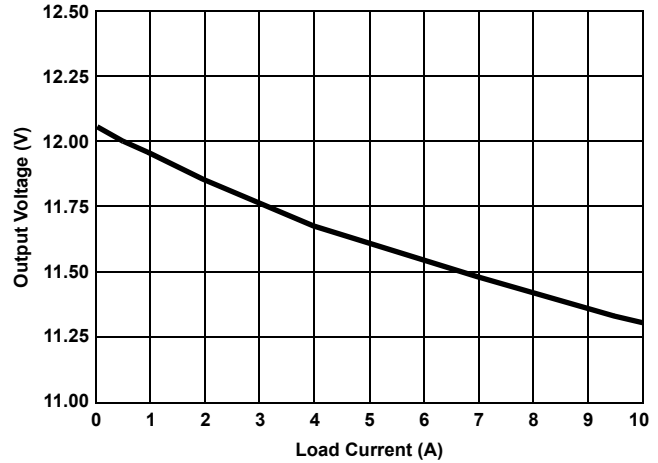

Figure 19. Load Regulation at $V_{IN} = 48V$

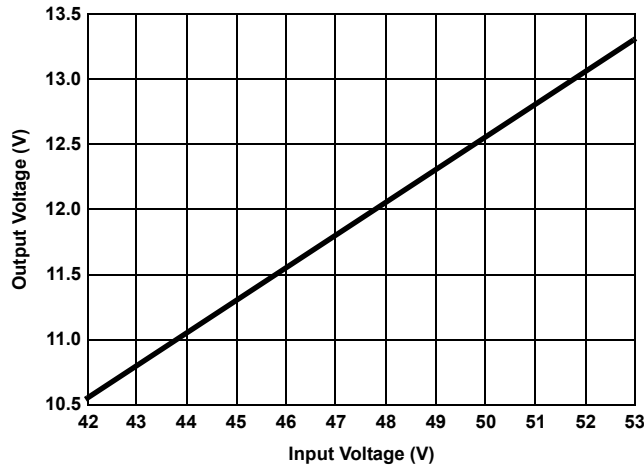

Figure 20. Line Regulation at $I_{OUT} = 1A$

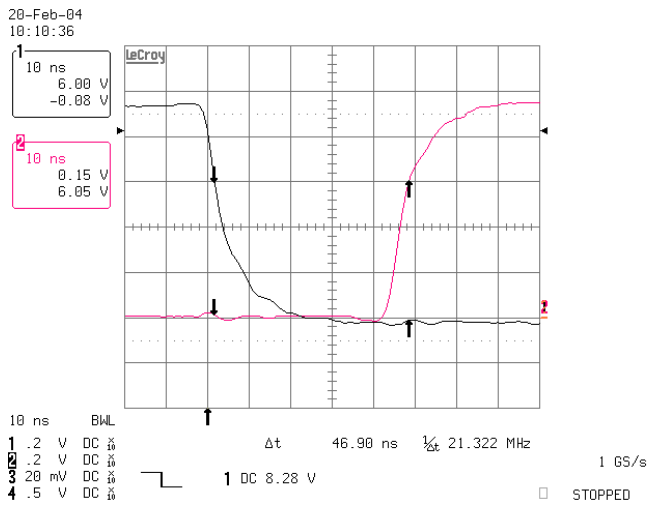

Figure 24. OUTA - OUTB Transition

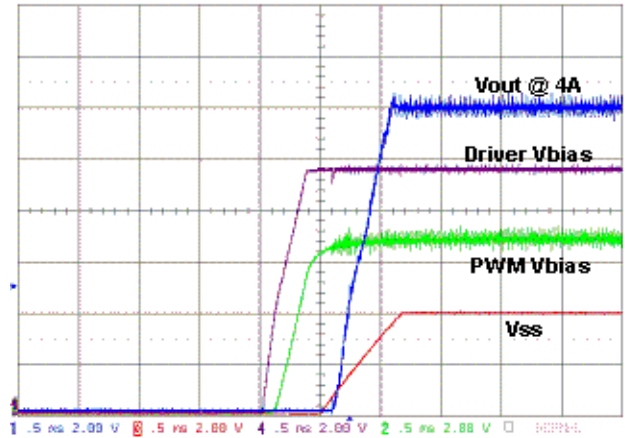

Figure 25. Output Soft-Start

6. Component List

Reference Designator	Value	Description
C1	1.0 μ F	Capacitor, 1812, X7R, 100V, 20%
C2, C3	3.3 μ F	Capacitor, 1812, X5R, 50V, 20%
C4	1.0 μ F	Capacitor, 0805, X5R, 16V, 10%
C5	0.1 μ F	Capacitor, 0603, X7R, 16V, 10%
C6, C15	4.7 μ F	Capacitor, 0805, X5R, 10V, 20%
C7	Open	Capacitor, 0603, Open or Optional Discrete Stray Capacitance
C8	22 μ F	Capacitor, 1812, X5R, 16V, 20%
C9	150 μ F	Capacitor, Radial, Sanyo 16SH150M
C10, C11, C12, C13, C14	1000pF	Capacitor, 0603, X7R, 50V, 10%
C16	150pF	Capacitor, 0603, COG, 16V, 5%
C18	0.01 μ F	Capacitor, 0603, X7R, 16V, 10%
CR1, CR2		Diode, Schottky, BAT54S, 30V
CR3		Diode, Schottky, BAT54, 30V
CR4		Diode, Schottky, SMA, 100V, 2.1A
D1		Zener, 10V, Zetex BZX84C10ZXCT-ND
D2		Zener, 2.7V, BZX84C2V7
L1	190nH	Pulse, P2004T
L2	1.5 μ H	Bitech, HM73-301R5
L3	Short	Jumper or Optional Discrete Leakage Inductance
P1, P2, P3, P4		Keystone, 1514-2
Q5	NPN	Transistor, ON MJD31C
QL, QH		FET, Fairchild FDS3672, 100V
QR1, QR2, QR3, QR4		FET, Fairchild FDS5670, 60V
R1	3.3	Resistor, 2512, 1%
R2	3.01k	Resistor, 2512, 1%
R5	5.11	Resistor, 0603, 1%
R6	205	Resistor, 0603, 1%
R7	75.0k	Resistor, 0805, 1%
R8, R9	20.0	Resistor, 0805, 1%
R10	18	Resistor, 2512, 1%
R11	100	Resistor, 0603, 1%
R12	10.0k	Resistor, 0603, 1%
T1	Custom	Midcom 31718
T2	Custom	Midcom 31719R
TP1, TP2, TP4, TP5, TP6	5002	Keystone
SP1		Tektronix Scope Jack, 131-4353-00
U1		Intersil ISL6744AAUZ, MSOP8
U4		Intersil ISL6700IB, SOIC

7. Revision History

Rev.	Date	Description
1.00	Aug 25, 2017	<p>Applied new formatting.</p> <p>Added Related Literature section.</p> <p>Updated Ordering information table.</p> <p>Update Absolute Maximum Ratings minimum values for Supply Voltage, OUTA, OUTB, and Signal Pins.</p> <p>Added Note 3. Moved Note 7 to end of EC table.</p> <p>Moved Pin Descriptions to table following Pin Configuration.</p> <p>Updated the Soft-Start Operation section on page 11.</p> <p>Added Revision History and About Intersil sections.</p> <p>Updated POD M8.118 to the latest revision. The updates are as follows:</p> <ul style="list-style-type: none"> -Updated to new POD template. Added land pattern. -Corrected lead width dimension in side view 1 from "0.25 - 0.036" to "0.25 - 0.36". <p>Updated POD M8.15 to the latest revision. The updates are as follows:</p> <ul style="list-style-type: none"> -Changed in Typical Recommended Land Pattern the following: 2.41(0.095) to 2.20(0.087) 0.76 (0.030) to 0.60(0.023) 0.200 to 5.20(0.205) -Changed Note 1 "1982" to "1994"

8. Package Outline Drawing

For the most recent package outline drawing, see [M8.118](#).

M8.118
 8 LEAD MINI SMALL OUTLINE PLASTIC PACKAGE
 Rev 4, 7/11

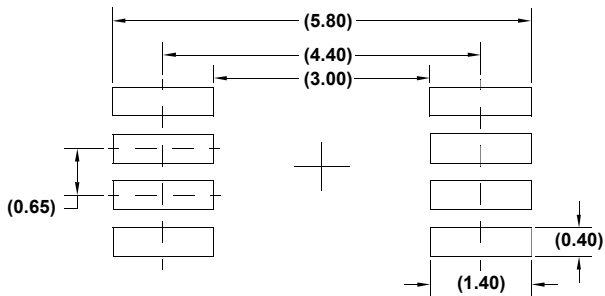
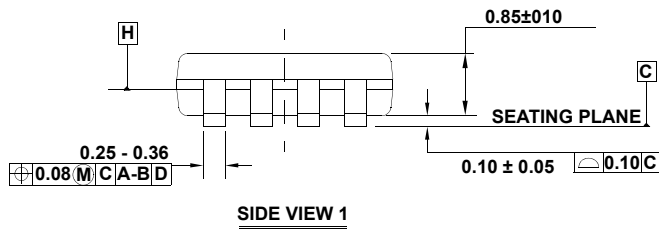
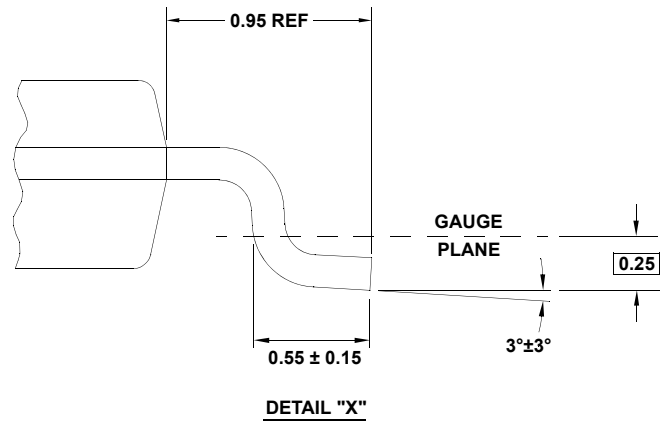
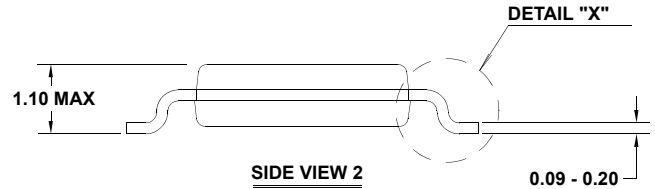
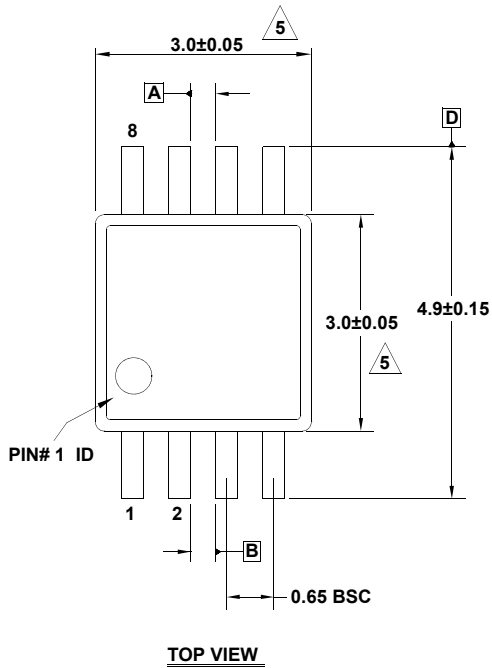

NOTES:

1. Dimensions are in millimeters.
2. Dimensioning and tolerancing conform to JEDEC MO-187-AA and AMSEY14.5m-1994.
3. Plastic or metal protrusions of 0.15mm max per side are not included.
4. Plastic interlead protrusions of 0.15mm max per side are not included.

△ 5. Dimensions are measured at Datum Plane "H".

6. Dimensions in () are for reference only.

M8.15
 8 LEAD NARROW BODY SMALL OUTLINE PLASTIC PACKAGE
 Rev 4, 1/12

For the most recent package outline drawing, see [M8.15](#).

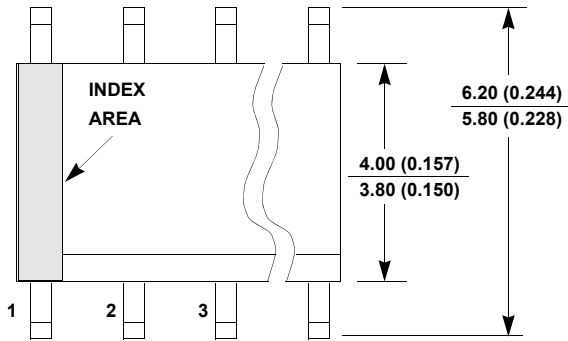

TOP VIEW

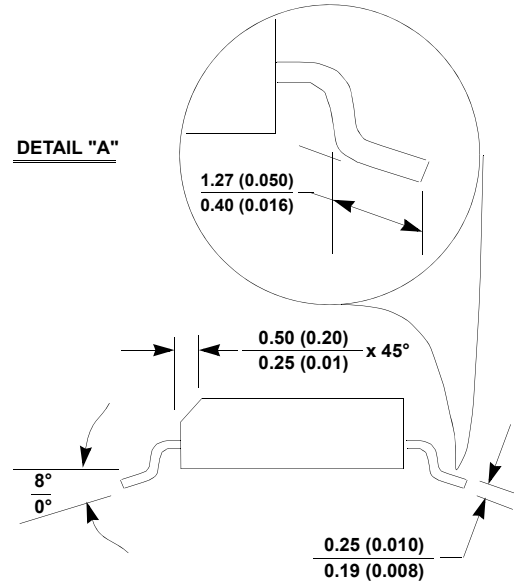

SIDE VIEW "B"

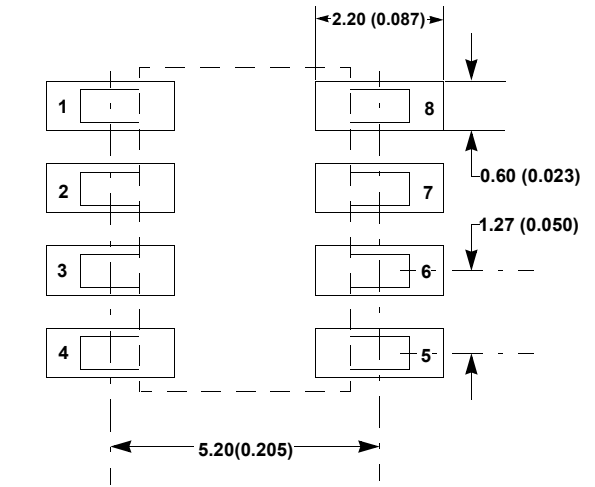

TYPICAL RECOMMENDED LAND PATTERN

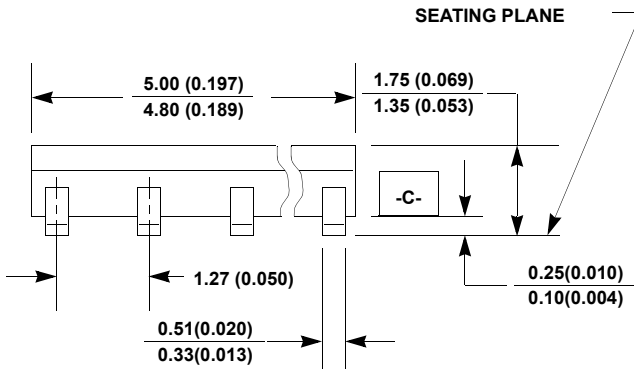

SIDE VIEW "A"

NOTES:

1. Dimensioning and tolerancing per ANSI Y14.5M-1994.
2. Package length does not include mold flash, protrusions or gate burrs. Mold flash, protrusion and gate burrs shall not exceed 0.15mm (0.006 inch) per side.
3. Package width does not include interlead flash or protrusions. Interlead flash and protrusions shall not exceed 0.25mm (0.010 inch) per side.
4. The chamfer on the body is optional. If it is not present, a visual index feature must be located within the crosshatched area.
5. Terminal numbers are shown for reference only.
6. The lead width as measured 0.36mm (0.014 inch) or greater above the seating plane, shall not exceed a maximum value of 0.61mm (0.024 inch).
7. Controlling dimension: MILLIMETER. Converted inch dimensions are not necessarily exact.
8. This outline conforms to JEDEC publication MS-012-AA ISSUE C.

9. About Intersil

Intersil Corporation is a leading provider of innovative power management and precision analog solutions. The company's products address some of the largest markets within the industrial and infrastructure, mobile computing, and high-end consumer markets.

For the most updated datasheet, application notes, related documentation, and related parts, see the respective product information page found at www.intersil.com.

For a listing of definitions and abbreviations of common terms used in our documents, visit: www.intersil.com/glossary.

You can report errors or suggestions for improving this datasheet by visiting www.intersil.com/ask.

Reliability reports are also available from our website at www.intersil.com/support.

**© Copyright Intersil Americas LLC 2007-2017. All Rights Reserved.
All trademarks and registered trademarks are the property of their respective owners.**

For additional products, see www.intersil.com/en/products.html

Intersil products are manufactured, assembled and tested utilizing ISO9001 quality systems as noted in the quality certifications found at www.intersil.com/en/support/qualandreliability.html

Intersil products are sold by description only. Intersil may modify the circuit design and/or specifications of products at any time without notice, provided that such modification does not, in Intersil's sole judgment, affect the form, fit or function of the product. Accordingly, the reader is cautioned to verify that datasheets are current before placing orders. Information furnished by Intersil is believed to be accurate and reliable. However, no responsibility is assumed by Intersil or its subsidiaries for its use; nor for any infringements of patents or other rights of third parties which may result from its use. No license is granted by implication or otherwise under any patent or patent rights of Intersil or its subsidiaries.

For information regarding Intersil Corporation and its products, see www.intersil.com



Компания «ЭлектроПласт» предлагает заключение долгосрочных отношений при поставках импортных электронных компонентов на взаимовыгодных условиях!

Наши преимущества:

- Оперативные поставки широкого спектра электронных компонентов отечественного и импортного производства напрямую от производителей и с крупнейших мировых складов;
- Поставка более 17-ти миллионов наименований электронных компонентов;
- Поставка сложных, дефицитных, либо снятых с производства позиций;
- Оперативные сроки поставки под заказ (от 5 рабочих дней);
- Экспресс доставка в любую точку России;
- Техническая поддержка проекта, помощь в подборе аналогов, поставка прототипов;
- Система менеджмента качества сертифицирована по Международному стандарту ISO 9001;
- Лицензия ФСБ на осуществление работ с использованием сведений, составляющих государственную тайну;
- Поставка специализированных компонентов (Xilinx, Altera, Analog Devices, Intersil, Interpoint, Microsemi, Aeroflex, Peregrine, Syfer, Eurofarad, Texas Instrument, Miteq, Cobham, E2V, MA-COM, Hittite, Mini-Circuits, General Dynamics и др.);

Помимо этого, одним из направлений компании «ЭлектроПласт» является направление «Источники питания». Мы предлагаем Вам помощь Конструкторского отдела:

- Подбор оптимального решения, техническое обоснование при выборе компонента;
- Подбор аналогов;
- Консультации по применению компонента;
- Поставка образцов и прототипов;
- Техническая поддержка проекта;
- Защита от снятия компонента с производства.



Как с нами связаться

Телефон: 8 (812) 309 58 32 (многоканальный)

Факс: 8 (812) 320-02-42

Электронная почта: org@eplast1.ru

Адрес: 198099, г. Санкт-Петербург, ул. Калинина, дом 2, корпус 4, литера А.