

Packaged PIN Diodes

RoHS Compliant

Rev V.9

Features

- ◆ High Power
- ◆ Fast Speed
- ◆ Voltage Ratings to 1500 Volts
- ◆ Wide Selection of Carrier Lifetimes
- ◆ Wide Selection of Capacitances
- ◆ Assortment of Packages Styles
- ◆ Available Screened for Military Applications

Description and Applications

M/A-COM's broad line of packaged PIN diodes encompasses a comprehensive range of electrical characteristics and package outlines. This diverse union of semiconductor technology and chip packaging gives considerable flexibility to the circuit designer. The fast switching series of packaged PIN diodes utilize a thin I-region and silicon oxide or glass passivated chips which provide for low leakage currents and low insertion loss. Using in process control monitors to regulate wafer fabrication parameters these devices achieve consistent performance in control circuit applications. The high voltage product line of packaged PIN diodes employs M/A-COM's unique CERMACHIP[®] passivation process which provides for a hard glass encapsulation that hermetically seals the active area of the chip. These packaged CERMACHIP[®] PIN diodes are ideally suited for use in high power applications where high RF voltages are present. The diode chips are bonded into sealed ceramic packages that are designed for the most stringent electrical and environmental conditions. A wide choice of packages are available which can be mounted into a variety of microwave and RF circuit media. The Packaged PIN Diodes series are designed to have a high inherent reliability and may be ordered screened to meet many MIL-STD reliability levels.

Maximum Power Dissipation

<u>Cathode Heatsink Packages</u> 30,31,32,36,43,94,111,120, 150,255 258,296,1072,1079	$P_{diss} = \frac{T(\text{max Operating}) - 25^{\circ}\text{C}}{\text{Thermal Resistance}}$
<u>Leaded Packages @+25°C</u> 144, 186, 276,1088	$P_{diss} = 250\text{mW}$
<u>Surface Mount Package +25°C</u> 1056	$P_{diss} = 300\text{mW}$

Co-Axial Packages

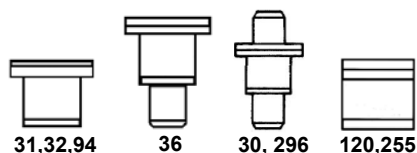

Leaded/Surface Mount Packages

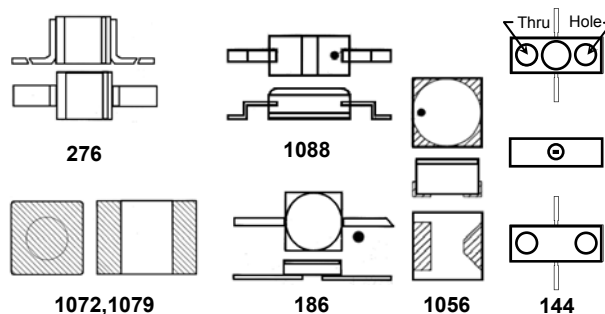

Threaded Packages

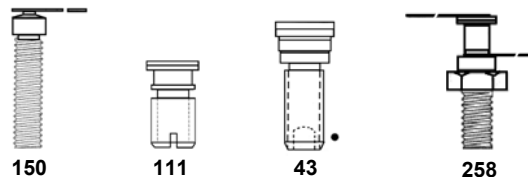

Unpackaged Die



131,132,134 , 212

Absolute Maximum Ratings¹

Parameter	Absolution Max.
Voltage	As Specified in Table
Operating Temperature	- 65°C to +175°C
Storage Temperature	- 65°C to +200°C
Operating and Storage (Case Style 1088)	- 65°C to +125°C

1. Operation beyond any one of the above conditions may cause permanent damage to the device.

Specifications subject to change without prior notification.

ADVANCED: Data Sheets contain information regarding a product M/A-COM is considering for development. Performance is based on target specifications, simulated results, and/or prototype measurements. Commitment to develop is not guaranteed.

PRELIMINARY: Data Sheets contain information regarding a product M/A-COM has under development. Performance is based on engineering tests. Specifications are typical. Mechanical outline has been fixed. Engineering samples and/or test data may be available. Commitment to produce in volume is not guaranteed.

- **North America** Tel: 800.366.2266 / Fax: 978.366.2266
 - **Europe** Tel: 44.1908.574.200 / Fax: 44.1908.574.300
 - **Asia/Pacific** Tel: 81.44.844.8296 / Fax: 81.44.844.8298
- Visit www.macomtech.com for additional data sheets and product information.

M/A-COM Technology Solutions Inc. and its affiliates reserve the right to make changes to the product(s) or information contained herein without notice.

Packaged PIN Diodes

RoHS Compliant

Rev V.9

35V to 250V Fast Switching PIN Diodes Specifications ($T_{AMB} = +25^{\circ}\text{C}$)

Part Number	Minimum Reverse Voltage ¹	(Unless otherwise specified) Maximum Capacitance	(Unless otherwise specified) Maximum Series Res.	Maximum Thermal Resistance	Nominal Characteristics		
	@ $I_R < 10\mu\text{A}$	$C_T @ -10\text{V}$ $f = 1\text{MHz}$ pF	$R_S @ 10\text{mA}$ $f = 500\text{MHz}$ Ω	$^{\circ}\text{C/W}$	Carrier Lifetime ⁴	T_{RR} ⁵	I-Region Width Microns
	Volts				nS	nS	μM
MA4P202-120	100	0.25	2.50	60	60	5	12
MA4P203-30	100	0.35	1.50	30	100	20	12
MA4P303-32	200	0.35	1.50	30	200	60	20
MA4P404-30	250	0.40 ²	0.60 ³	20	1000	100	30

Notes:

- The minimum specified V_R (Reverse Voltage) is sourced and the resultant reverse leakage current, I_R , is measured to be $<10\mu\text{A}$
- At $V_R = -50\text{V}$
- R_S measured at $I_F = +50\text{mA}$, $f = 100\text{MHz}$.
- Nominal carrier life time specified with diode biased at $I_F = +10\text{mA}$, $I_{REV} = -6\text{mA}$
- Nominal T_{RR} (reverse recovery time) specified with diode biased at $I_F = +20\text{mA}$, $I_{REV} = -200\text{mA}$.

Package Options

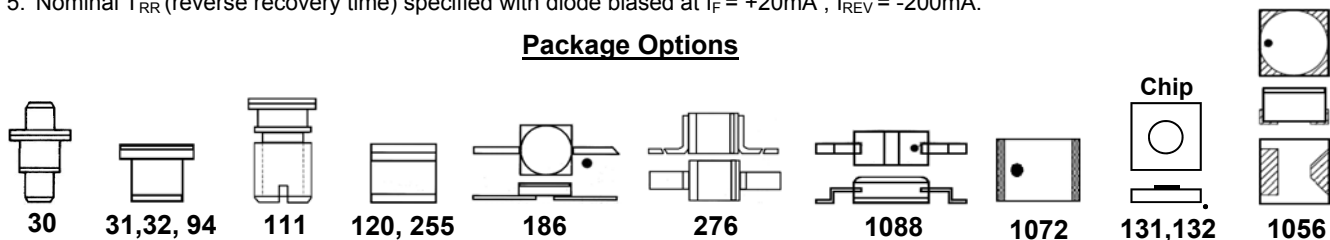

Package dimensions can be found on the M/A-COM website at <http://www.macom.com/TechApps/OutlineDrawings.asp>

35V to 500V MELF General Purpose Switching Diodes Specifications ($T_{AMB} = +25^{\circ}\text{C}$)

Part Number ¹	Minimum Reverse Voltage ²	Maximum Capacitance	(Unless otherwise specified) Maximum Series Res.	CW Power Dissipation Rating	Nominal Characteristics		
	$I_R < 10\mu\text{A}$	$C_T @ 10\text{V}$ $f = 1\text{MHz}$ pF	$R_S @ 10\text{mA}$ $f = 100\text{MHz}$ Ω	Watts	Typical I_F When $R_S = 75\Omega$ mA	Carrier Lifetime ³	I-Region Width
	Volts				μS	mils	
MA4PH235-1072T	35	1.2	0.5	1.0	—	0.3	0.4
MA4PH236-1072T	200	0.5	3.0	1.0	—	1.5	2.0
MA4PH237-1079T	200	1.5	0.6@50mA	2.0	—	3.0	3.0
MA4PH238-1072T	200	0.5	6.0	1.0	0.30-0.60	2.0	4.0
MA4PH239-1079T	200	0.8	25.0	2.0	1.20-2.40	6.0	14.0
MADP-000234-10720T	500	1.5 ⁴	0.25@100mA	5.0	—	3.0	2.0

Notes:

- Only available in case styles indicated.
- The minimum specified V_R (Reverse Voltage) is sourced and the resultant reverse leakage current, I_R , is measured to be $<10\mu\text{A}$.
- Nominal carrier life time specified with diode biased at $I_F = +10\text{mA}$, $I_{REV} = -6\text{mA}$
- C_t tested at 100V



Case Styles 1072, 1079

ADVANCED: Data Sheets contain information regarding a product M/A-COM is considering for development. Performance is based on target specifications, simulated results, and/or prototype measurements. Commitment to develop is not guaranteed.

PRELIMINARY: Data Sheets contain information regarding a product M/A-COM has under development. Performance is based on engineering tests. Specifications are typical. Mechanical outline has been fixed. Engineering samples and/or test data may be available. Commitment to produce in volume is not guaranteed.

- **North America** Tel: 800.366.2266 / Fax: 978.366.2266
- **Europe** Tel: 44.1908.574.200 / Fax: 44.1908.574.300
- **Asia/Pacific** Tel: 81.44.844.8296 / Fax: 81.44.844.8298

Visit www.macomtech.com for additional data sheets and product information.

M/A-COM Technology Solutions Inc. and its affiliates reserve the right to make changes to the product(s) or information contained herein without notice.

Packaged PIN Diodes

RoHS Compliant

Rev V.9

500V PIN Diodes Specifications ($T_{AMB} = +25^{\circ}\text{C}$)

Part Number	Minimum Reverse Voltage ¹	Maximum Capacitance	Maximum Series Resistance	CW Power Dissipation Rating	Nominal Characteristics	
	$I_R < 10\mu\text{A}$ Volts	$C_T @ 100\text{V}$ $f = 1\text{ MHz}$ pF	$R_S @ 100\text{mA}$ $f = 100\text{ MHz}$ Ω	Watts	Carrier Lifetime ² μS	I-Region Width mils
MA4P504-30	500	0.40	0.60	10	1.0	2
MADP000015-000030 ³	500	0.55	0.45	15	2.0	2
MA4P506-30	500	0.90	0.30	15	3.0	2

Notes:

1. The minimum specified V_R (Reverse Voltage) is sourced and the resultant reverse leakage current, I_R , is measured to be $<10\mu\text{A}$.
2. Nominal carrier life time specified with diode biased at $I_F = +10\text{mA}$, $I_{REV} = -6\text{mA}$
3. To order this part in a package other than 30, use the prefix MA4P505 followed by a dash and the desired package style.

Package Options

Consult the Package Availability Table in the "Ordering Information" section (pg. 7) for part number choices.

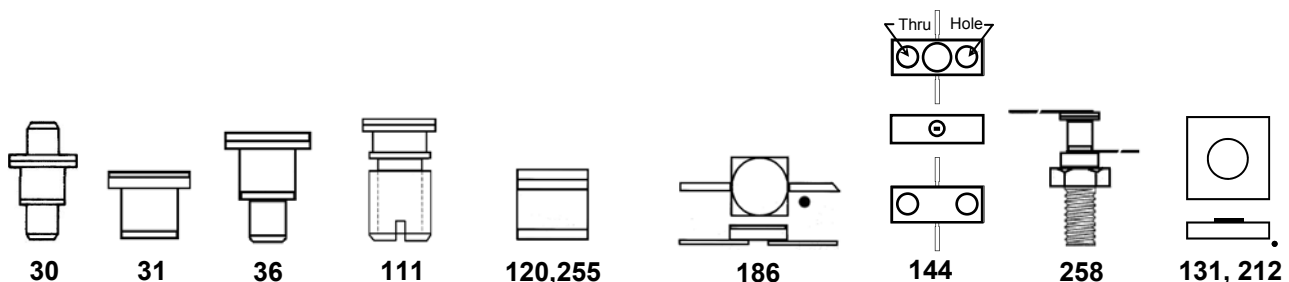

Package dimensions can be found on the M/A-COM website at <http://www.macomtech.com/TechApps/OutlineDrawings.asp>

500V MELF PIN Diode Specifications ($T_{AMB} = +25^{\circ}\text{C}$)

Part Number	Minimum Reverse Voltage ¹	Maximum Capacitance	Maximum Series Resistance	CW Power Dissipation Rating	Nominal Characteristics	
	$I_R < 10\mu\text{A}$ Volts	$C_T @ 100\text{V}$ $f = 1\text{ MHz}$ pF	$R_S @ 100\text{mA}$ $f = 100\text{ MHz}$ Ω	Watts	Carrier Lifetime ² μS	I-Region Width mils
MA4P504-1072T	500	0.5	0.60	10	1.0	2
MA4P505-1072T	500	0.65	0.45	15	2.0	2
MA4P506-1072T	500	1.0	0.30	15	3.0	2

Notes:

1. The minimum specified V_R (Reverse Voltage) is sourced and the resultant reverse leakage current, I_R , is measured to be $<10\mu\text{A}$.
2. Nominal carrier life time specified with diode biased at $I_F = +10\text{mA}$, $I_{REV} = -6\text{mA}$

1072 Package



Specifications subject to change without prior notification.

ADVANCED: Data Sheets contain information regarding a product M/A-COM is considering for development. Performance is based on target specifications, simulated results, and/or prototype measurements. Commitment to develop is not guaranteed.

PRELIMINARY: Data Sheets contain information regarding a product M/A-COM has under development. Performance is based on engineering tests. Specifications are typical. Mechanical outline has been fixed. Engineering samples and/or test data may be available. Commitment to produce in volume is not guaranteed.

- **North America** Tel: 800.366.2266 / Fax: 978.366.2266
 - **Europe** Tel: 44.1908.574.200 / Fax: 44.1908.574.300
 - **Asia/Pacific** Tel: 81.44.844.8296 / Fax: 81.44.844.8298
- Visit www.macomtech.com for additional data sheets and product information.

M/A-COM Technology Solutions Inc. and its affiliates reserve the right to make changes to the product(s) or information contained herein without notice.

Packaged PIN Diodes

RoHS Compliant

Rev V.9

1000V CERMACHIP PIN Diodes Specification ($T_{AMB} = +25^{\circ}\text{C}$)

Part Number	Minimum Reverse Voltage ¹	Maximum Capacitance	Maximum Series Resistance	CW Power Dissipation Rating	Nominal Characteristics	
	$I_R < 10\mu\text{A}$ Volts	$C_T @ 100\text{V}$ $f = 1\text{MHz}$ pF	$R_s @ 100\text{mA}$ $f = 100\text{MHz}$ Ω	Watts	Carrier Lifetime ² μS	I-Region Width Mils
MA4P604-30	1000	0.50	1.00	15	3.0	4
MA4P606-30	1000	0.80	0.70	20	4.0	4
MA4P607-43	1000	2.00	0.40	25	5.0	4

Notes:

- The maximum specified V_R (reverse voltage) is sourced and the resultant reverse leakage current, I_r , is measured to be $< 10\mu\text{A}$
- Nominal carrier life time specified with diode biased at $I_F = +10\text{mA}$, $I_{REV} = -6\text{mA}$

Package Options

Consult table in "Ordering Information" section (pg. 7) for availability

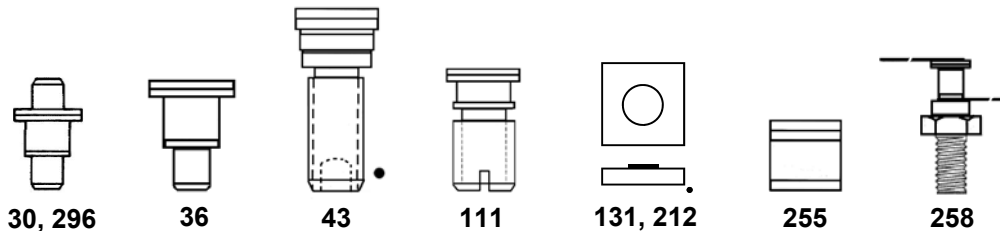

Package dimensions can be found on the M/A-COM website at <http://www.macomtech.com/TechApps/OutlineDrawings.asp>

1500V CERMACHIP PIN Diode Specifications ($T_{AMB} = +25^{\circ}\text{C}$)

Part Number	Minimum Reverse Voltage ¹	Maximum Capacitance	Maximum Series Resistance	Maximum Thermal Resistance	Nominal Characteristics	
	$I_R < 10\mu\text{A}$ Volts	$C_t @ 100\text{V}$ $f = 1\text{MHz}$ pF	$R_s @ 200\text{mA}$ $f = 100\text{MHz}$ Ω	$^{\circ}\text{C/W}$	Carrier Lifetime ² μS	I-Region Width mils
MA4P709-150	1500	3.30	0.25	2	10.0	7

Notes:

- The minimum specified V_R (reverse voltage) is sourced and the resultant reverse leakage current, I_r , is measured to be $< 10\mu\text{A}$
- Nominal carrier life time specified with diode biased at $I_F = +10\text{mA}$, $I_{REV} = -6\text{mA}$

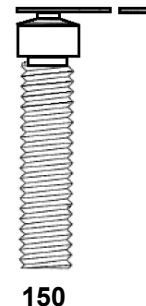

Specifications subject to change without prior notification.

ADVANCED: Data Sheets contain information regarding a product M/A-COM is considering for development. Performance is based on target specifications, simulated results, and/or prototype measurements. Commitment to develop is not guaranteed.
PRELIMINARY: Data Sheets contain information regarding a product M/A-COM has under development. Performance is based on engineering tests. Specifications are typical. Mechanical outline has been fixed. Engineering samples and/or test data may be available. Commitment to produce in volume is not guaranteed.

- **North America** Tel: 800.366.2266 / Fax: 978.366.2266
- **Europe** Tel: 44.1908.574.200 / Fax: 44.1908.574.300
- **Asia/Pacific** Tel: 81.44.844.8296 / Fax: 81.44.844.8298

Visit www.macomtech.com for additional data sheets and product information.

M/A-COM Technology Solutions Inc. and its affiliates reserve the right to make changes to the product(s) or information contained herein without notice.

Packaged PIN Diodes

RoHS Compliant

Rev V.9

Forward Current vs. Series Resistance
MA4P202, MA4P203, MA4P303 and MA4P404
 100MHz

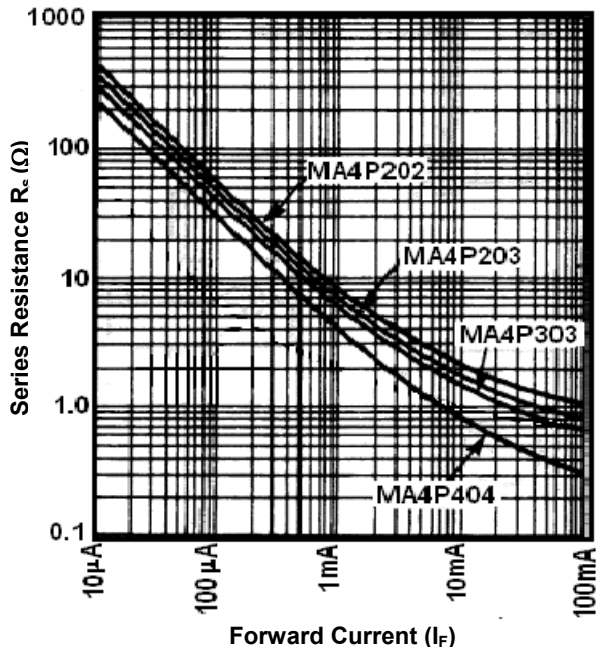

Forward Current vs. Series Resistance
MA4P504, MA4P505 and MA4P506
 100MHz

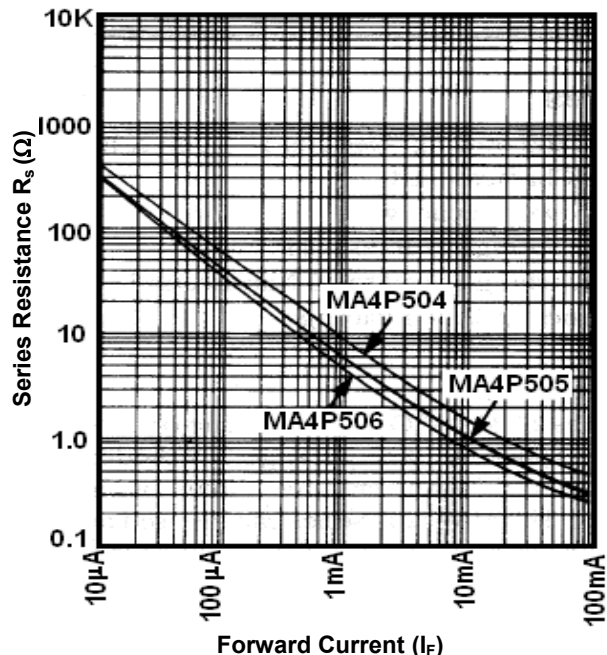

Forward Current vs. Series Resistance
MA4P604, MA4P606 and MA4P607
 100MHz

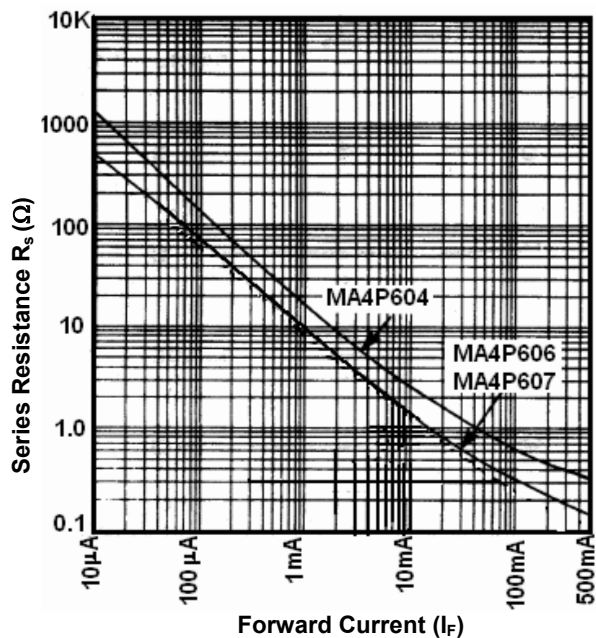

Forward Current vs. Series Resistance
MA4P709
 100MHz

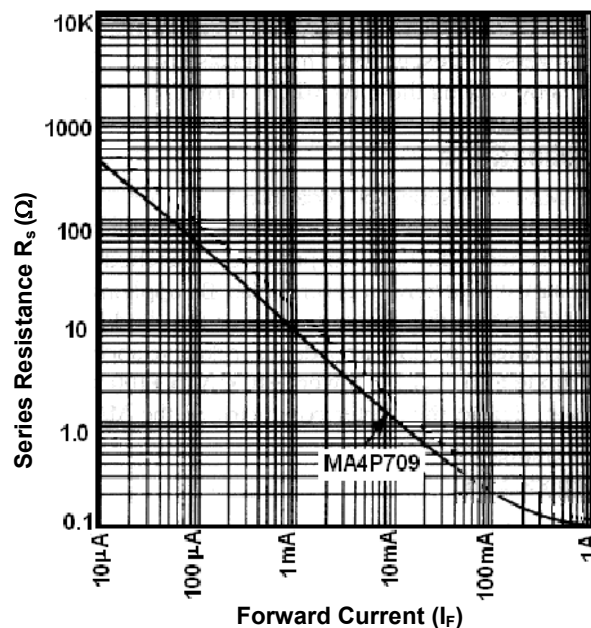

ADVANCED: Data Sheets contain information regarding a product M/A-COM is considering for development. Performance is based on target specifications, simulated results, and/or prototype measurements. Commitment to develop is not guaranteed.

PRELIMINARY: Data Sheets contain information regarding a product M/A-COM has under development. Performance is based on engineering tests. Specifications are typical. Mechanical outline has been fixed. Engineering samples and/or test data may be available. Commitment to produce in volume is not guaranteed.

- **North America** Tel: 800.366.2266 / Fax: 978.366.2266
 - **Europe** Tel: 44.1908.574.200 / Fax: 44.1908.574.300
 - **Asia/Pacific** Tel: 81.44.844.8296 / Fax: 81.44.844.8298
- Visit www.macomtech.com for additional data sheets and product information.

M/A-COM Technology Solutions Inc. and its affiliates reserve the right to make changes to the product(s) or information contained herein without notice.

Packaged PIN Diodes

RoHS Compliant

Rev V.9

Recommended Groups B&C Testing Per MIL-STD 750

Recommended methods and conditions for Groups B and C, TX and TXV level screening.

Inspection	Method	Condition
Storage Temperature	1031	See Maximum Ratings
Operating Temperature	—	See Maximum Ratings
Temperature Cycling	1051	5 cycles - 65°C to +150°C
Shock	2016	500g's
Vibration	2056	15g's
Constant Acceleration	2006	20,000g's
Humidity	1021	10 Days

Recommended Screening Per MIL-STD 750

Recommended methods and conditions for TX and TXV level screening.

Inspection	Method	Condition
Internal Visual and / or X-Ray	2072, 2076	See Note
High Temp. Storage	1032	48 hours min. @ max. storage temp.
Thermal Shock	1051	10 Cycles
Constant Acceleration	2006	20,000 g's, Y1
Fine Leak	1071	H
Gross Leak	1071	C or E
Electrical	—	See Note
Burn-In	1038	See Note

Notes:

1. Conditions and details of test depend on specific model number. Information available upon request.
2. Case styles 1056 and 1088 are not military, MIL-STD-750, rated packages.

ADVANCED: Data Sheets contain information regarding a product M/A-COM is considering for development. Performance is based on target specifications, simulated results, and/or prototype measurements. Commitment to develop is not guaranteed.

PRELIMINARY: Data Sheets contain information regarding a product M/A-COM has under development. Performance is based on engineering tests. Specifications are typical. Mechanical outline has been fixed. Engineering samples and/or test data may be available. Commitment to produce in volume is not guaranteed.

- **North America** Tel: 800.366.2266 / Fax: 978.366.2266
 - **Europe** Tel: 44.1908.574.200 / Fax: 44.1908.574.300
 - **Asia/Pacific** Tel: 81.44.844.8296 / Fax: 81.44.844.8298
- Visit www.macomtech.com for additional data sheets and product information.

M/A-COM Technology Solutions Inc. and its affiliates reserve the right to make changes to the product(s) or information contained herein without notice.

Packaged PIN Diodes

RoHS Compliant

Rev V.9

Maximum Soldering Temperature

For hand soldering operation:

Case Style: 144, 150*, 186, 258*, 1088, 1072, 1079 ♦ 265°C maximum for 5 seconds

Case Style: 120, 255, 276 ♦ 265°C maximum for 5 seconds.

Case Style: 30*, 31, 32, 36*, 43*, 94, 111*, 296* ♦ 225°C maximum for 5 seconds.

***Note:**

Package styles that are threaded or have pronged ends rely on a pressure connection and do not require solder attachment but can be soldered if desired.

For solder reflow profiles:

Refer to application note M-538 on the M/A-COM website using the following link:

<http://www.macomtech.com/Application%20Notes/pdf/M538.pdf>

Ordering Information

The Packaged PIN Diode specifications shown in the tables on pages 2, 3, & 4 are for the standard style package. The standard package style is indicated by the number following the dash after the base part number. Note that the specification tables lists the total diode capacitance for the standard case style. The total capacitance for the base part in an alternative package will differ and is computed by adding the junction capacitance of the chip and the parasitic capacitance of the alternative package as defined in the **Package Parasitic Capacitance** table below. To compute the chip junction capacitance, subtract the total capacitance shown in the specifications tables on pages 2, 3, & 4 from the appropriate standard style package capacitance below. The various base part numbers are only available in the case styles shown in the **Package Availability Table** below. To order, indicate the base part number followed by a dash and the desired package style.

For example: The MA4P506-258 is the MA4P506 chip in the 258 style package.

Package Availability Table

Base Part Number	Available ODS Package Styles
MA4P202	120, 134, 276, 1056
MA4P203	30, 32, 94, 111, 134, 1056
MA4P303	32, 36, 94, 120, 186, 255, 1088
MA4P404	30, 31, 36, 111, 132, 258, 1072T*
MA4P504	30, 120, 132, 144, 186, 255, 1072T*
MA4P505	36, 131, 255, 1072T*
MA4P506	30, 31, 36, 131, 255, 258, 1072T*
MA4P604	30, 43, 131, 255, 258
MA4P606	30, 36, 131, 258
MA4P607	43, 212, 296
MA4P709	150
MADP000015-000030	30
MA4PH235	1072T*
MA4PH236	1072T*
MA4PH237	1079T*
MA4PH238	1072T*
MA4PH239	1079T*
MADP-000234	10720T* (1072 package style)

***Note:** "T" after the package style number indicates tape and reel.

Package Parasitic Capacitance

Package Style	Cap. (pF)
30	0.18
31	0.18
32	0.30
36	0.18
43	0.75
94	0.15
111	0.27
120	0.13
131	N/A (chip)
132	N/A (chip)
134	N/A (chip)
144	0.42
186	0.15
212	N/A (chip)
255	0.30
258	0.18
276	0.13
296	0.35
1056	0.20
1072	0.16
1079	0.13
1088	0.12

Tape and reel information can be found on the M/A-COM website at <http://www.macomtech.com/Application%20Notes/pdf/M513.pdf>

Package dimensions can be found on the M/A-COM website at <http://www.macomtech.com/TechApps/OutlineDrawings.asp>

ADVANCED: Data Sheets contain information regarding a product M/A-COM is considering for development. Performance is based on target specifications, simulated results, and/or prototype measurements. Commitment to develop is not guaranteed.

PRELIMINARY: Data Sheets contain information regarding a product M/A-COM has under development. Performance is based on engineering tests. Specifications are typical. Mechanical outline has been fixed. Engineering samples and/or test data may be available. Commitment to produce in volume is not guaranteed.

- **North America** Tel: 800.366.2266 / Fax: 978.366.2266
 - **Europe** Tel: 44.1908.574.200 / Fax: 44.1908.574.300
 - **Asia/Pacific** Tel: 81.44.844.8296 / Fax: 81.44.844.8298
- Visit www.macomtech.com for additional data sheets and product information.

M/A-COM Technology Solutions Inc. and its affiliates reserve the right to make changes to the product(s) or information contained herein without notice.



Компания «ЭлектроПласт» предлагает заключение долгосрочных отношений при поставках импортных электронных компонентов на взаимовыгодных условиях!

Наши преимущества:

- Оперативные поставки широкого спектра электронных компонентов отечественного и импортного производства напрямую от производителей и с крупнейших мировых складов;
- Поставка более 17-ти миллионов наименований электронных компонентов;
- Поставка сложных, дефицитных, либо снятых с производства позиций;
- Оперативные сроки поставки под заказ (от 5 рабочих дней);
- Экспресс доставка в любую точку России;
- Техническая поддержка проекта, помощь в подборе аналогов, поставка прототипов;
- Система менеджмента качества сертифицирована по Международному стандарту ISO 9001;
- Лицензия ФСБ на осуществление работ с использованием сведений, составляющих государственную тайну;
- Поставка специализированных компонентов (Xilinx, Altera, Analog Devices, Intersil, Interpoint, Microsemi, Aeroflex, Peregrine, Syfer, Eurofarad, Texas Instrument, Miteq, Cobham, E2V, MA-COM, Hittite, Mini-Circuits, General Dynamics и др.);

Помимо этого, одним из направлений компании «ЭлектроПласт» является направление «Источники питания». Мы предлагаем Вам помощь Конструкторского отдела:

- Подбор оптимального решения, техническое обоснование при выборе компонента;
- Подбор аналогов;
- Консультации по применению компонента;
- Поставка образцов и прототипов;
- Техническая поддержка проекта;
- Защита от снятия компонента с производства.



Как с нами связаться

Телефон: 8 (812) 309 58 32 (многоканальный)

Факс: 8 (812) 320-02-42

Электронная почта: org@eplast1.ru

Адрес: 198099, г. Санкт-Петербург, ул. Калинина, дом 2, корпус 4, литера А.